

IEC Appliance Inlet C8, Screw-on or Rivet Mounting, Front Side, Solder, PCB or Quick-connect Terminal



See below:

**Approvals and Compliances**

**Description**

- Panel mount :  
Screw-on mounting , from front side
- Appliance Inlet , Pin temperature 70 °C , Protection class II
- Solder, Quick Connect or PCB Terminal
- Solder terminals in horizontal or vertical orientation

**Characteristics**

- Contact pins are turned from solid material

**References**

We recommend for new applications the type [0720-FS](#)

**Weblinks**

[pdf data sheet](#), [html datasheet](#), [General Product Information](#), [Approvals](#), [Distributor-Stock-Check](#), [Accessories](#), [Detailed request for product](#)

**Technical Data**

Ratings IEC	2.5 A / 250 VAC; 50Hz	Appliance inlet/-outlet	C8 acc. to IEC 60320-1, UL 498, CSA C22.2 no. 42 (for cold conditions) pin-temperature 70 °C, 2.5A, Protection Class II
Ratings UL/CSA	2.5 A / 250VAC; 60Hz		
Dielectric Strength	> 3 kVAC between L-N > 1.5 kVAC between L/N-PE (1 min/50Hz)		
Allowable Operation Temperature	-25 °C to 70 °C		
IP-Protection	from front side IP20 acc. to IEC 60529		
Protection against electric shock	Suitable for appliances with protection class II acc. to IEC 61140		
Material: Housing	PA6, black / grey / white, UL 94V-0		

**Approvals and Compliances**

Detailed information on product approvals, code requirements, usage instructions and detailed test conditions can be looked up in [Details about Approvals](#)

SCHURTER products are designed for use in industrial environments. They have approvals from independent testing bodies according to national and international standards. Products with specific characteristics and requirements such as required in the automotive sector according to IATF 16949, medical technology according to ISO 13485 or in the aerospace industry can be offered exclusively with customer-specific, individual agreements by SCHURTER.

**Approvals**



The approval mark is used by the testing authorities to certify compliance with the safety requirements placed on electronic products.

Approval Reference Type: 2573

Approval Logo	Certificates	Certification Body	Description
	<a href="#">VDE Approvals</a>	VDE	VDE Certificate Number: 40034368
	<a href="#">UL Approvals</a>	UL	UL File Number: E96454
	<a href="#">CSA Approvals</a>	CSA	CSA Certification Record: 27324

**Product standards**

Product standards that are referenced

Organization	Design	Standard	Description
	Designed according to	IEC 60320-1	Appliance couplers for household and similar general purposes
	Designed according to	UL 498	Standard for Attachment Plugs and Receptacles
	Designed according to	CSA C22.2 no. 42	General Use Receptacles, Attachment Plugs, and Similar Wiring Devices





**Application standards**

Application standards where the product can be used

Organization	Design	Standard	Description
	Designed for applications acc.	IEC/UL 62368-1	IEC 62368-1 includes the basic requirements for safety of audio, video, information technology and office equipment.

**Compliances**

The product complies with following Guide Lines

Identification	Details	Initiator	Description
	<a href="#">CE declaration of conformity</a>	SCHURTER AG	The CE marking declares that the product complies with the applicable requirements laid down in the harmonisation of Community legislation on its affixing in accordance with EU Regulation 765/2008.
	RoHS	SCHURTER AG	Directive RoHS 2011/65/EU, Amendment (EU) 2015/863
	China RoHS	SCHURTER AG	The law SJ / T 11363-2006 (China RoHS) has been in force since 1 March 2007. It is similar to the EU directive RoHS.
	REACH	SCHURTER AG	On 1 June 2007, Regulation (EC) No 1907/2006 on the Registration, Evaluation, Authorization and Restriction of Chemicals 1 (abbreviated as "REACH") entered into force.

**Dimensions [mm]**

PCB terminal with additional solder terminal in orientation A (horizontal)

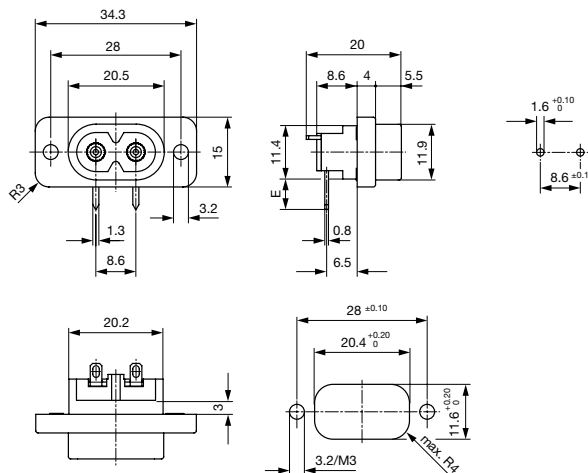

- E = PCB terminal standard (additional solder): 6.9 mm
- E = PCB terminal short (additional solder): 0.6 mm
- E = PCB terminal long (additional solder): 15.9 mm
- E = PCB terminal standard: 6.6 mm
- E = PCB terminal short: 5.0 mm
- E = PCB terminal long: 7.7 mm

PCB terminal with additional solder terminal in orientation A (horizontal), screw-on mounting with pre-inserted nuts

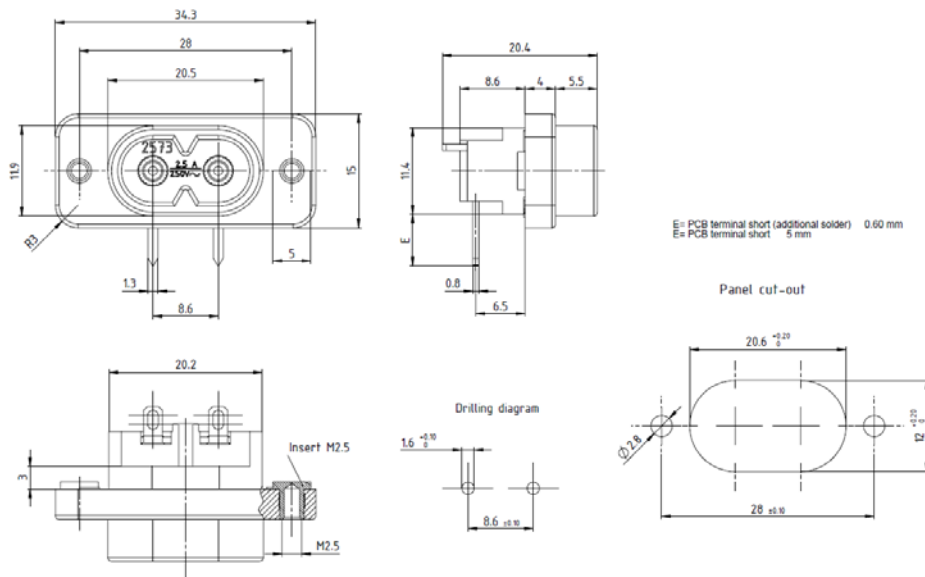

- E = PCB terminal standard (additional solder): 6.9 mm
- E = PCB terminal short (additional solder): 0.6 mm
- E = PCB terminal long (additional solder): 15.9 mm
- E = PCB terminal standard: 6.6 mm
- E = PCB terminal short: 5.0 mm
- E = PCB terminal long: 7.7 mm

1) Insert nut

Quick connect or solder terminal in orientation A (horizontal) or B (vertical)

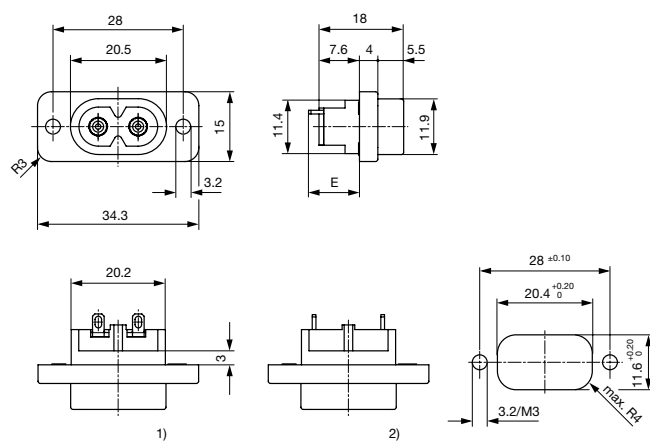

- E = Solder terminal short: 11.0 mm
- E = Solder terminal long: 14.7 mm (only orientation B)
- E = Quick-connect terminal 2.8x0.8 mm: 17.0 mm
- E = Quick-connect terminal 4.8x0.8 mm: 15.5 mm (only orientation B)

- 1) Orientation of terminal: A
- 2) Orientation of terminal: B

**Config. Code**











2573 - H - A B C 0 - D - E G F

The characters are placeholders for the correspondingly keys of selections from the key tables.

2573 - H - A B C 0 - D - E G F = Type

Type	Configuration key
protection class II	X

2573 - H - A B C 0 - D - E G F = Terminals

Terminal L	Configuration key
short solder terminal (L = 4.8 mm) 	2
long solder terminal (L = 8.5 mm) 	3
PCB-terminal standard (additional solder terminal) 	4
PCB-terminal short (additional solder terminal) 	5
PCB-terminal long (additional solder terminal) 	6
Blade terminal (2.8 x 0.8 mm) 	7
Blade terminal (4.8 x 0.8 mm) 	8
PCB-terminal (standard) 	A
PCB-terminal (short) 	B
PCB-terminal (long) 	C

2573 - H - A B C 0 - D - E G F = Terminals

Terminal N	Configuration key
short solder terminal (L = 4.8 mm)	2
long solder terminal (L = 8.5 mm)	3

Symbols similar as in table A

Terminal N	Configuration key
PCB-terminal standard (additional solder terminal)	4
PCB-terminal short (additional solder terminal)	5
PCB-terminal long (additional solder terminal)	6
Blade terminal (2.8 x 0.8 mm)	7
Blade terminal (4.8 x 0.8 mm)	8
PCB-terminal (standard)	A
PCB-terminal (short)	B
PCB-terminal (long)	C

Symbols similar as in table A

2573 - H - A B C 0 - D - E G F = Terminals

Terminal Ground	Configuration key
without terminal	0

Symbols similar as in table A

2573 - H - A B C 0 - D - E G F = Color

Color	Configuration key
Black	A
Grey	B
White	D

2573 - H - A B C 0 - D - E G F = Style

Style	Configuration key
flange with through holes	2
flange with through holes (special type)	7

2573 - H - A B C 0 - D - E G F = Dimension S

Dimension "S"	Configuration key
00	

The dimension "S" is displayed in (1/10 mm). This information is also valid for the order code

2573 - H - A B C 0 - D - E G F = Orientation of Terminals

Orientation of Terminals	Configuration key
horizontal	A
vertical	B

**All Variants**

Terminals L / N	Orientation of Terminals	Color	Style	Config. Code	Order Number
short solder terminal (L = 4.8 mm)	horizontal	Black	flange with through holes	2573-X-2200-A-200A	6160.0012
short solder terminal (L = 4.8 mm)	vertical	Black	flange with through holes	2573-X-2200-A-200B	6160.0013
long solder terminal (L = 8.5 mm)	vertical	Black	flange with through holes	2573-X-3300-A-200B	6160.0014
PCB-terminal short (additional solder terminal)	horizontal	Black	flange with through holes (special type)	2573-X-5500-A-700A	6160.0015
Blade terminal (2.8 x 0.8 mm)	horizontal	Black	flange with through holes	2573-X-7700-A-200A	6160.0016

The listed variants should be available from stock. Other versions on request [www.schurter.com/contact](http://www.schurter.com/contact)

Most Popular.

Availability for all products can be searched real-time: <https://www.schurter.com/en/Stock-Check/Stock-Check-SCHURTER>

**Packaging unit** 100 Pcs