

PLEASE CHECK WWW.MOLEX.COM FOR LATEST PART INFORMATION

Part Number: [0545480871](#)
Status: **Active**
Overview: [FFC-FPC \(SMT\)](#)
Description: 0.50mm Pitch Easy-On FFC/FPC Connector, 1.20mm Height, Right-Angle, Surface Mount, ZIF, Bottom Contact Style, 8 Circuits, Gold (Au) Plating

Documents:

3D Model	Application Specification AS-54548-001-001 (PDF)
Drawing (PDF)	Packaging Specification SPK-54548-001-001 (PDF)
Product Specification PS-54548-039-001 (PDF)	RoHS Certificate of Compliance (PDF)

Agency Certification

UL E29179

General

Product Family	FFC/FPC Connectors
Series	54548
Overview	FFC-FPC (SMT)
Product Name	Easy-On
UPC	822350019613

Physical

Actuator Type	Slider
Circuits (Loaded)	8
Contact Position	Bottom
Durability (mating cycles max)	20
Mated Height	1.20mm
Material - Metal	Phosphor Bronze
Material - Plating Mating	Gold
Material - Plating Termination	Tin
Net Weight	57.298/mg
Number of Rows	1
Orientation	Right Angle
PCB Locator	No
PCB Mounting	Surface Mount
PCB Retention	Yes
Packaging Type	Embossed Tape on Reel
Pitch - Mating Interface	0.50mm
Polarized to PCB	Yes
Stackable	No
Temperature Range - Operating	-20° to +85°C
Wire/Cable Type	FFC/FPC

Electrical

Current - Maximum per Contact	0.5A
Voltage - Maximum	50V

Material Info

Reference - Drawing Numbers

Application Specification	AS-54548-001-001
Packaging Specification	SPK-54548-001-001
Product Specification	PS-54548-039-001
Sales Drawing	SD-54548-039, SD-54548-040

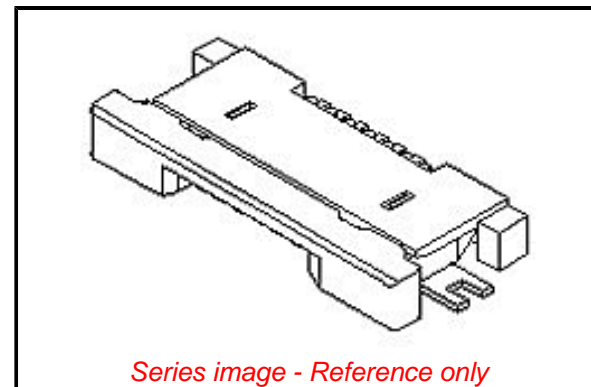

EU ELV

Not Relevant

EU RoHS

Compliant

REACH SVHC

Not Contained Per -
ED/61/2018 (27 June
2018)

Halogen-Free

Status

Not Low-Halogen

For more information, please visit [Contact US](#)

China ROHS

ELV

RoHS Phthalates

China RoHS

Green Image

Not Relevant

Not Contained

Search Parts in this Series

[54548 Series](#)

PLEASE CHECK WWW.MOLEX.COM FOR LATEST PART INFORMATION