

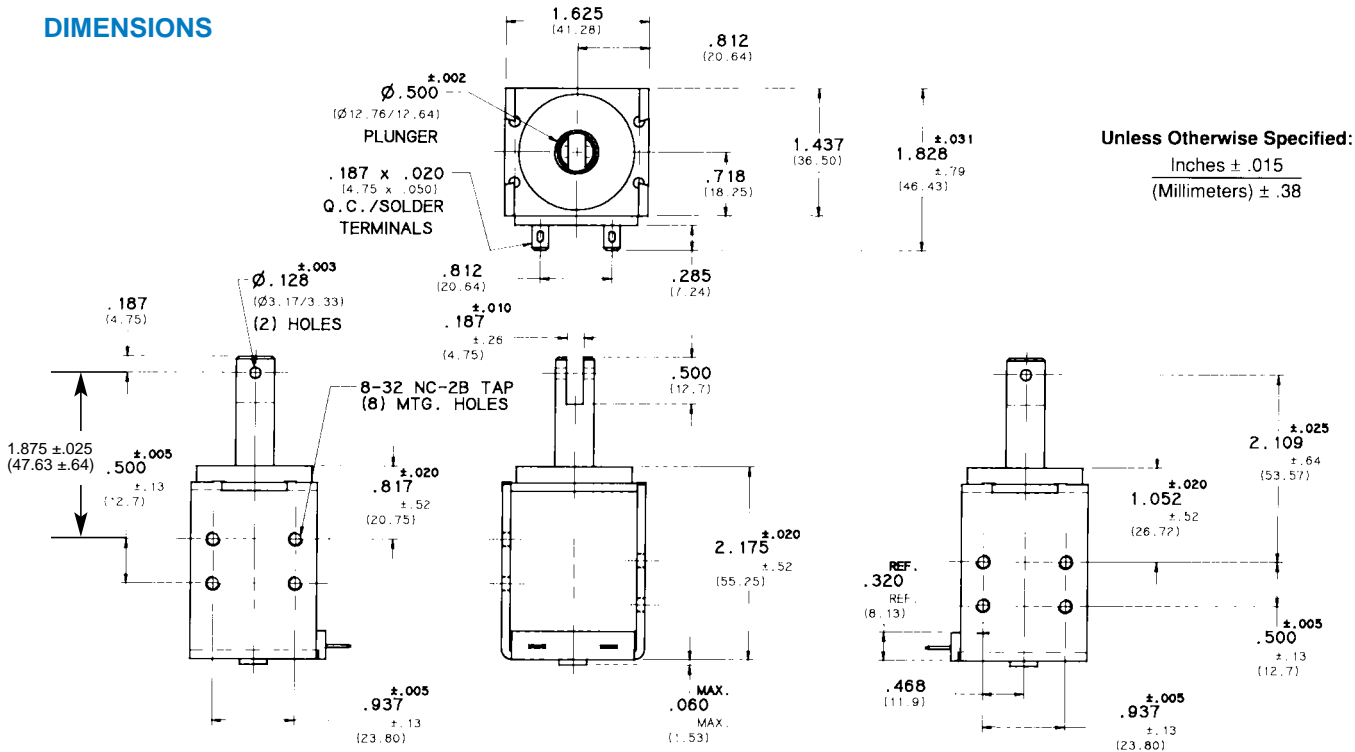

# D-4HD "D" FRAME SOLENOID

## DIMENSIONS



### COIL TREATMENT:

Plastic Encapsulation.  
 Class A Rating (standard)  
 Class F Rating (optional)

### MAXIMUM OPERATING TEMPERATURE:

Class A – 105°C (221°F)  
 Class F – 155°C (311°F)

### DIELECTRIC STRENGTH:

30 Volts and Under: 500 VRMS  
 Over 30 Volts: 1,000 VRMS plus 2x rated voltage for one minute

### STANDARD POWER RATINGS:

DUTY	NOMINAL AC POWER (SEATED)	NOMINAL DC POWER
Continuous	31 VA	11.5 W
Intermittent	145 VA	38 W
Pulse	310 VA	115 W

### UL INFORMATION:

UL File No. E57982 For Continuous Duty  
 UL File No. E74443 For Insulation Systems  
 S105, S130, S130D, S130D1 & S155D

### WEIGHT:

Plunger – 2.38 Oz.  
 Total – 13 Oz.

### PLUNGER GUIDE MATERIAL:

Plastic

### LIFE EXPECTANCY:

10<sup>7</sup> Cycles Under Optimum Load Conditions

### TERMINATION:

.187 In. Quick-Connect/Solder Lug (standard)  
 .250 In. Quick-Connects (optional)  
 Wire Leads (optional with tape-wrapped coils)

### PLUNGER CONE ANGLE (DC):

60 degrees (standard)  
 also available flat, 90 degrees, custom

### MAXIMUM DIMENSIONS:

Length 2.195 In.  
 Width 1.859 In.  
 Height 1.640 In.  
 Plunger Diameter ø.502 In.

### MAXIMUM STROKE:

1.000 In.

## D-4HD STANDARD COIL RATING

VOLTAGE	CONTINUOUS DUTY	RESISTANCE AC ±10% DC ±5%	INTERMITTENT DUTY	RESISTANCE AC ±10% DC ±5%	PULSE DUTY	RESISTANCE AC ±10% DC ±5%
<b>AC COILS (60 Hz)</b>	<b>P/N</b>		<b>P/N</b>		<b>PN</b>	
6 VAC	—	—	—	—	—	—
12 VAC	53720-81	.588 OHMS	—	—	—	—
24 VAC	53720-82	2.38 OHMS	53720-88	.689 OHMS	53720-94	.453 OHMS
120 VAC	53720-84*	61.1 OHMS	53720-90*	17.7 OHMS	53720-96	11.7 OHMS
240 VAC	53720-85	247 OHMS	53720-91	71.8 OHMS	53720-97	48.2 OHMS
<b>DC COILS</b>						
6 VDC	53719-80	2.88 OHMS	53719-86	.924 OHMS	53719-92	.316 OHMS
12 VDC	53719-81*	11.7 OHMS	53719-87*	3.75 OHMS	53719-93	1.28 OHMS
24 VDC	53719-82*	48.2 OHMS	53719-88*	15.2 OHMS	53719-94	5.10 OHMS
110 VDC	53719-84	1033 OHMS	53719-90	328 OHMS	53719-96	105 OHMS

\*Black Items Are Normally Stocked.

Blue Items Are Non Stock – Minimum Quantity May Be Required.

## D-4HD FORCE CURVES (CLASS A)

AC CONTINUOUS DUTY - 31VA

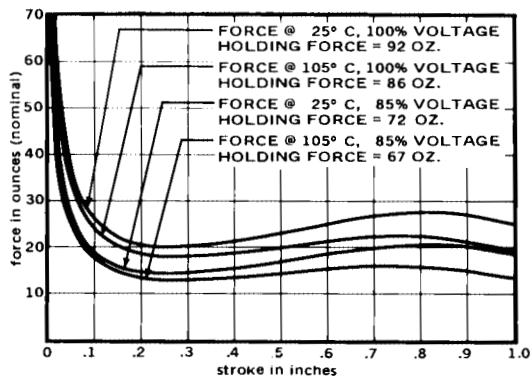

DC CONTINUOUS DUTY - 11.5 WATTS

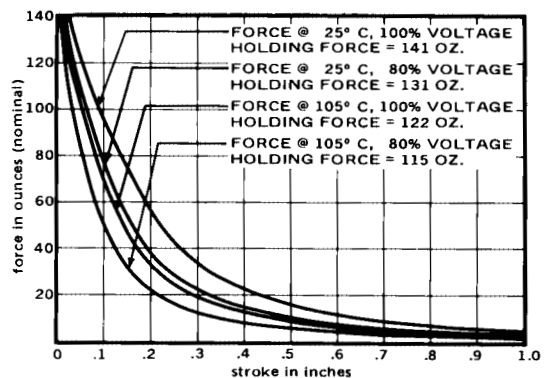

AC INTERMITTENT DUTY - 145VA

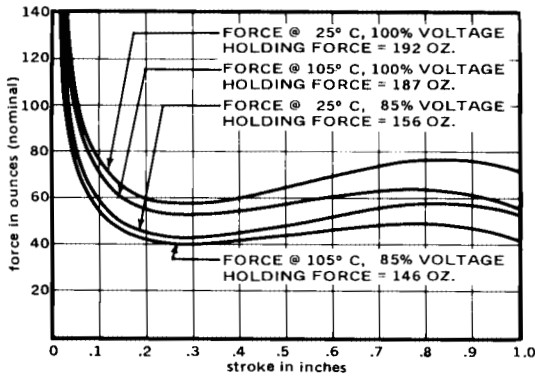

DC INTERMITTENT DUTY - 38 WATTS

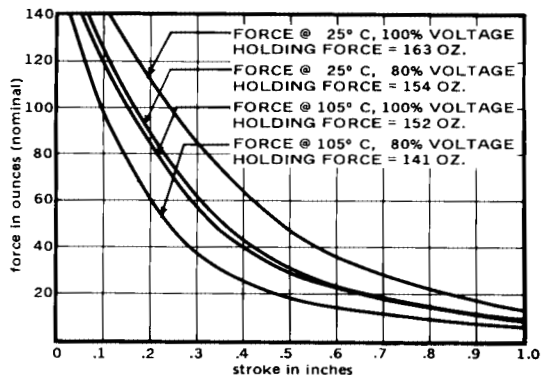

AC PULSE DUTY - 310VA

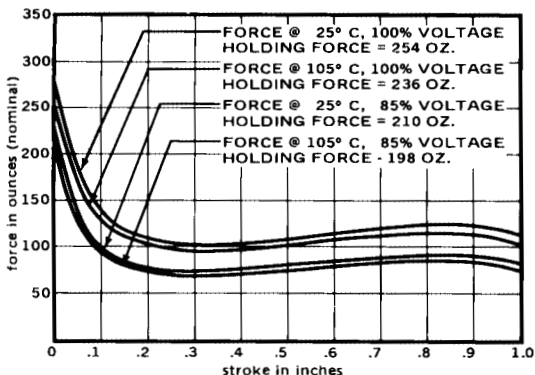

DC PULSE DUTY - 115 WATTS

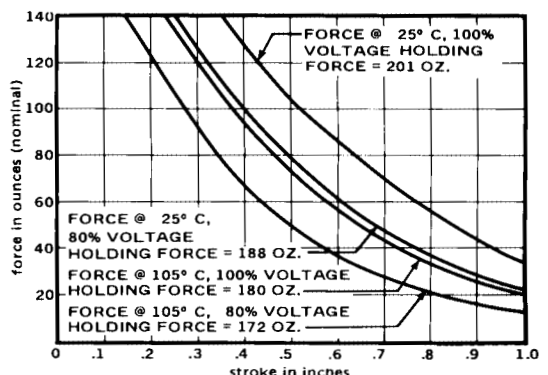

Standard intermittent duty cycle at nominal voltage is 25%, with 3 minutes maximum "ON" and 9 minutes minimum "OFF" in a repetitive cycle. Standard Pulse duty cycle is 10% with 100 milliseconds "ON" and 900 milliseconds "OFF".

NOTE: Approx. 36 sq. in. Heat Sink Required.