

C-9 "C" FRAME SOLENOID

DIMENSIONS

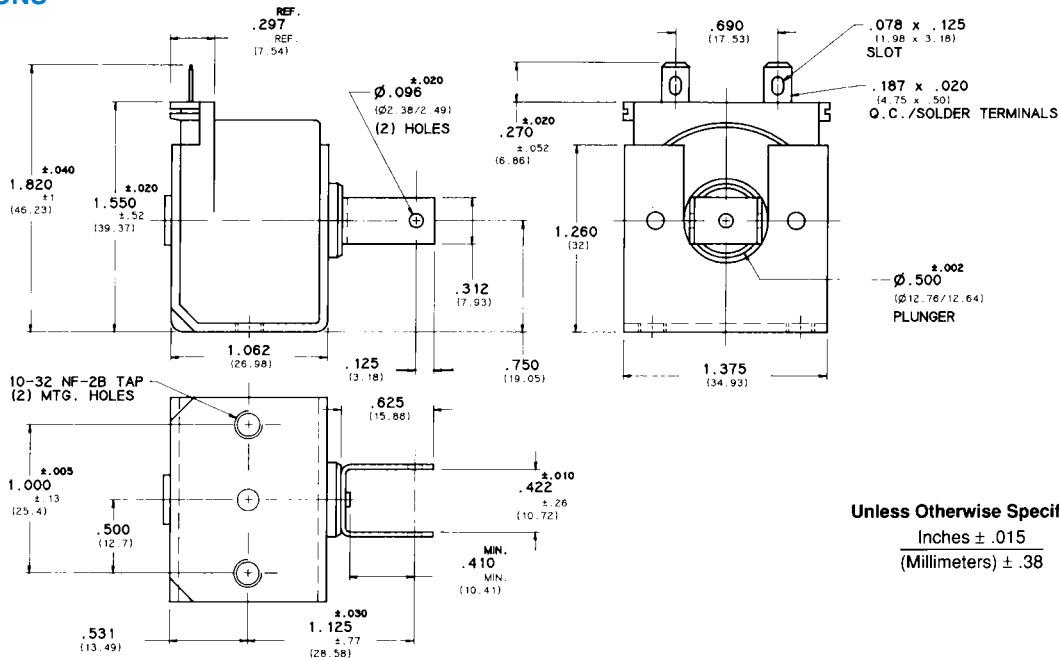

Unless Otherwise Specified:
 Inches ± .015
 (Millimeters) ± .38

COIL TREATMENT:

Plastic Encapsulation.
 Class A Rating (standard)
 Class F Rating (optional)

MAXIMUM OPERATING TEMPERATURE:

Class A – 105°C (221°F)
 Class F – 155°C (311°F)

DIELECTRIC STRENGTH:

30 Volts and Under: 500 VRMS
 Over 30 Volts: 1,000 VRMS plus 2x rated voltage for one minute

STANDARD POWER RATINGS:

DUTY	NOMINAL AC POWER (SEATED)	NOMINAL DC POWER
Continuous	13.7 VA	8.6 W
Intermittent	52 VA	15.5 W
Pulse	137 VA	86 W

UL INFORMATION:

UL File No. E57982 For Continuous Duty
 UL File No. E74443 For Insulation Systems
 S105, S130, S130D, S130D1 & S155D

WEIGHT:

Plunger – .9 Oz.
 Total – 5 Oz.

PLUNGER GUIDE MATERIAL:

Plastic

LIFE EXPECTANCY:

10⁷ Cycles Under Optimum Load Conditions

TERMINATION:

.187 In. Quick-Connect/Solder Lug (standard)
 .250 In. Quick-Connects (optional)
 Wire Leads (optional with tape-wrapped coils)

PLUNGER CONE ANGLE (DC):

60 degrees (standard)
 also available flat, 90 degrees, custom
 Buzz Trimmer (AC) (optional)

MAXIMUM DIMENSIONS:

Length 1.077 In.
 Width 1.390 In.
 Height 1.860 In.
 Plunger Diameter Ø.502 In.

MAXIMUM STROKE:

.500 In.

C-9 STANDARD COIL RATING

VOLTAGE	CONTINUOUS DUTY	RESISTANCE AC ±10% DC ±5%	INTERMITTENT DUTY	RESISTANCE AC ±10% DC ±5%	PULSE DUTY	RESISTANCE AC ±10% DC ±5%
AC COILS (60 Hz)	P/N		P/N		P/N	
6 VAC	53673-80	.58 OHMS	53674-80	.20 OHMS	53675-80	.09 OHMS
12 VAC	53673-81	2.3 OHMS	53674-81	1.82 OHMS	53675-81	.390 OHMS
24 VAC	53673-82	9.3 OHMS	53674-83	3.3 OHMS	53675-83	1.6 OHMS
120 VAC	53673-94*	240 OHMS	53674-94*	84.1 OHMS	53675-94	37.6 OHMS
240 VAC	53673-97	960 OHMS	53674-97	342 OHMS	53675-97	143 OHMS
DC COILS						
6 VDC	53676-80	4.1 OHMS	53677-80	2.3 OHMS	53678-80	.390 OHMS
12 VDC	53676-81	16.5 OHMS	53677-81	9.3 OHMS	53678-81	1.6 OHMS
24 VDC	53676-83	66.5 OHMS	53677-83	37.6 OHMS	53678-83	6.7 OHMS
110 VDC	53676-93	1430 OHMS	53677-93	788 OHMS	53678-93	143 OHMS

*Black Items Are Normally Stocked.

Blue Items Are Non Stock – Minimum Quantity May Be Required.

C-9 FORCE CURVES (CLASS A)

AC CONTINUOUS DUTY - 13.7VA

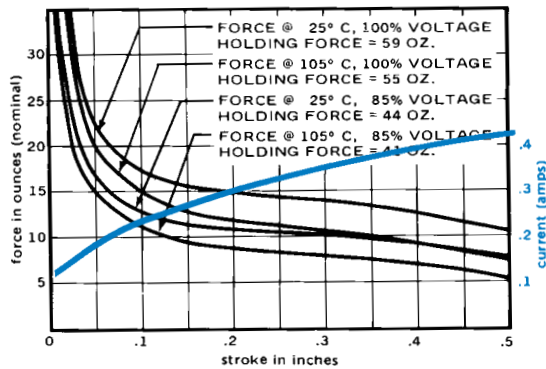

DC CONTINUOUS DUTY - 8.6 WATTS

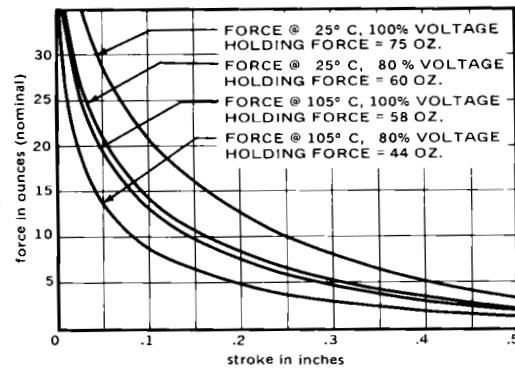

AC INTERMITTENT DUTY - 52VA

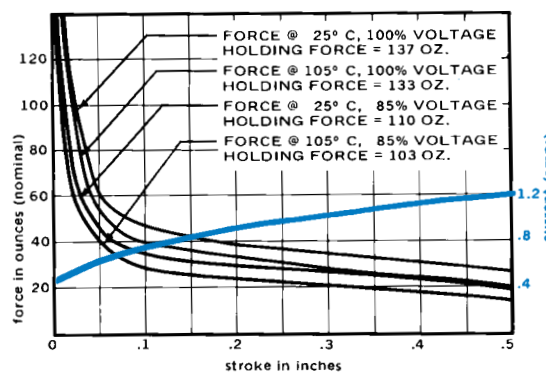

DC INTERMITTENT DUTY - 15.5 WATTS

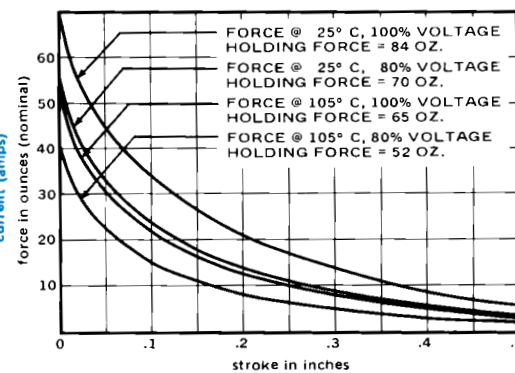

AC PULSE DUTY - 137VA

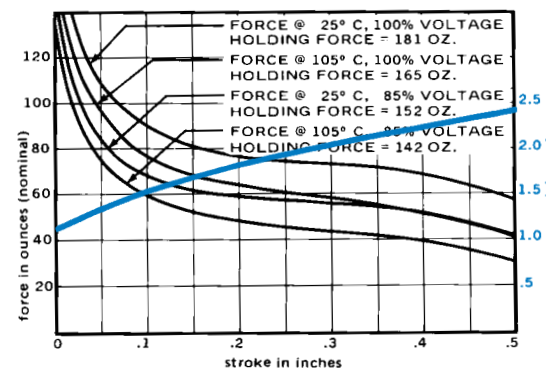

DC PULSE DUTY - 86 WATTS

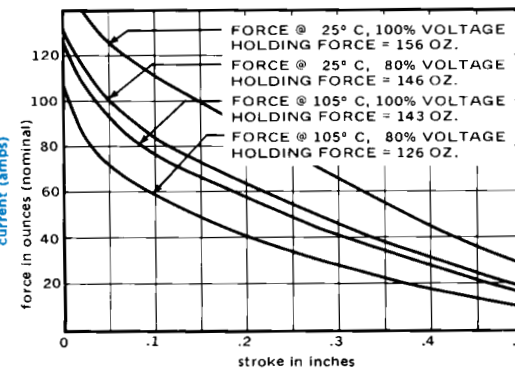

Standard intermittent duty cycle at nominal voltage is 25%, with 3 minutes maximum "ON" and 9 minutes minimum "OFF" in a repetitive cycle. Standard Pulse duty cycle is 10% with 100 milliseconds "ON" and 900 milliseconds "OFF".

*AC Intermittent duty winding based on 20% duty cycle with 1 minute maximum "on" time.

NOTE: Approx. 36 sq. in. Heat Sink Required.