

**PLEASE CHECK WWW.MOLEX.COM FOR LATEST PART INFORMATION**

**Part Number:** [0529910708](#)  
**Status:** **Active**  
**Overview:** SlimStack™ 0.50mm Pitch Board-to-Board Connectors  
**Description:** 0.50mm Pitch SlimStack™ Receptacle, Surface Mount, Dual Row, Vertical, 3.00 and 4.00mm Stacking Heights, Lower Circuit Size Version, White, 70 Circuits

**Documents:**

<a href="#">3D Model</a>	<a href="#">Product Specification PS-54167-002-001 (PDF)</a>
<a href="#">Drawing (PDF)</a>	<a href="#">Packaging Specification SPK-52991-001-001 (PDF)</a>
<a href="#">Product Specification PS-52991-003-001 (PDF)</a>	<a href="#">RoHS Certificate of Compliance (PDF)</a>
<a href="#">Product Specification PS-52991-008-001 (PDF)</a>	

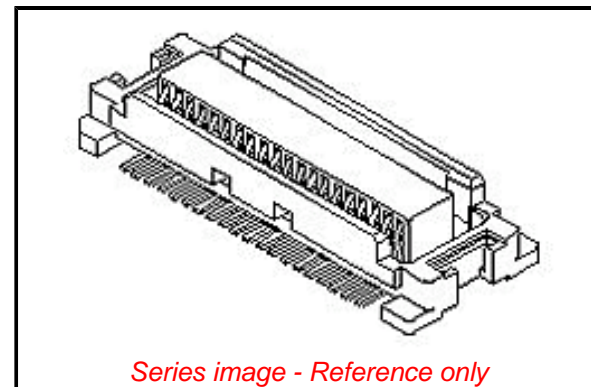

**Agency Certification**

UL E29179

**General**

Product Family	PCB Receptacles
Series	<a href="#">52991</a>
Application	Board-to-Board, Signal
Overview	<a href="#">SlimStack™ 0.50mm Pitch Board-to-Board Connectors</a>
Product Name	SlimStack™
UPC	800754364508

**Physical**

Circuits (Loaded)	70
Circuits (maximum)	70
Glow-Wire Compliant	No
Mated Height	3.00mm, 4.00mm
Material - Plating Mating	Gold
Material - Plating Termination	Gold
Net Weight	262.101/mg
Number of Rows	2
Orientation	Vertical
PCB Locator	No
PCB Retention	None
PCB Thickness - Recommended	1.60mm
Packaging Type	Embossed Tape on Reel
Pitch - Mating Interface	0.50mm
Plating min - Mating	0.102µm
Plating min - Termination	0.254µm
Polarized to PCB	No
Surface Mount Compatible (SMC)	N/A
Temperature Range - Operating	-40°C to +105°C
Termination Interface: Style	Surface Mount

**Electrical**

Current - Maximum per Contact	0.5A
Voltage - Maximum	50V

**Material Info**

**Reference - Drawing Numbers**

Packaging Specification	SPK-52991-001-001
Product Specification	PS-52991-003-001, PS-52991-008-001, PS-54167-002-001
Sales Drawing	SD-52991-004, SD-52991-005

**EU ELV**

**Not Relevant**

**EU RoHS**

**Compliant**

**REACH SVHC**

Not Contained Per - ED/30/2017 (7 July 2017)

**Halogen-Free**

**Status**

**Low-Halogen**

**Need more information on product environmental compliance?**

Email [productcompliance@molex.com](mailto:productcompliance@molex.com)  
Please visit the [Contact Us](#) section for any non-product compliance questions.

China ROHS	Green Image
ELV	Not Relevant
RoHS Phthalates	Not Contained

**Search Parts in this Series**

[52991](#) Series

**Mates With**

Board-to-Board SlimStack™ Plug [53748](#) , [53916](#) , [501920](#)

This document was generated on 08/01/2017

**PLEASE CHECK [WWW.MOLEX.COM](http://WWW.MOLEX.COM) FOR LATEST PART INFORMATION**