



516 SERIES

RACK AND PANEL CONNECTOR (PLUG AND RECEPTACLE)



FEATURES:

- .150" (3.81mm) Contact Spacing x .130" (3.30mm) or .150" (3.81mm) Row Spacing with staggered Grid
- Plug and Receptacle in 20, 38, 56, 90 and 120 Contact Sizes
- Edacon Hermaphroditic Contact Mating Design
- Contact Termination Options include Crimp, P.C. Tail, Wire Hole and Wire Wrap
- Mating and Unmating Simplified with use of Actuating Screws
- Optional Covers with Side or Top Entry Cable Clamp in Plastic or Metal material Available for all Connector Sizes
- Versatile Metal Cover Design permits Assembly or Disassembly After Cabling is Complete plus Cable Entry Style Flexibility
- Actuating Screws, Locknuts, Polarizing Hardware, Covers and Contacts Suitable for either Plug or Receptacle
- Polarizing Hardware Adjustable for 288 Mating Combinations
- Tools Available for Contact Installation, Removal and Crimping and Polarizing Changes
- RoHS Compliant & UL Certified

Specifications:

Insulator Material	Diallyl Phthalate, Thermoplastic Polyester or Polycarbonate UL 94V-0
Color	Green or Grey
Contact Material	Copper Alloy
Contact Plating	Gold Plating over Nickel over entire contact
Current Rating	8.5 Amperes
Contact Resistance	10 milliohms maximum
Withstanding Voltage	2000 VAC rms at sea level
Insulation Resistance	5000 Megaohms minimum
Operating Temp	-40°C to +125°C (Diallyl Phthalate Only)
Operating Temp	-40°C to +105°C
Insertion & Withdrawal Force	2 to 16 Oz (0.56 to 4.45N) per contact position

Example Part Number:

516-038-500-212

Series _____
 Total Number of Contacts _____
 Contact Code _____
 Style and Material _____
 Cover Code _____
 Hardware Code _____

Cover Code 4, 5, 6, 7

Description

0	No Cover Assembly
1	Plastic Cover, Top Entry Standard Clamp
2	Plastic Cover, Side Entry Standard Clamp
3	Plastic Cover, Top Entry Large Clamp
4	Plastic Cover, Side Entry Large Clamp
5	Metal Cover, Side Entry
6	Metal Cover, Top Entry

Series 516

Total Number of Contacts 020, 038, 056, 090 or 120

Contact Code 1,2	Description & Tail Size	Tail Length "G"
000	No Contacts Assembled	-----
500	Wire Hole .110 x .024 (2.79 x 0.61)	.245 (6.22)
520	P.C. Tail .25 x .024 (0.64 x 0.61)	.215 (5.46)
540	Wire Wrap .050 x .024 (1.27 x 0.61)	.600 (15.24)
541	Wire Wrap .026 x .024 (0.66 x 0.61)	.620 (15.70)
542	Wire Wrap .050 x .024 (1.27 x 0.61)	.790 (20.07)

Hardware Code 8

Description

0	No Hardware
1	Actuating Screw & Polarizing Hardware
2	Locknut & Polarizing Hardware
5	Actuating Screw with No Polarizing Hardware
6	Locknut with No Polarizing Hardware

Style & Material 3	Style	Insulator Material
1	Plug	Green Diallyl Phthalate
2	Receptacle	Green Diallyl Phthalate
3	Plug	Grey Polycarbonate
4	Receptacle	Grey Polycarbonate
5	Plug	Green Polyester
6	Receptacle	Green Polyester

www.edac.net

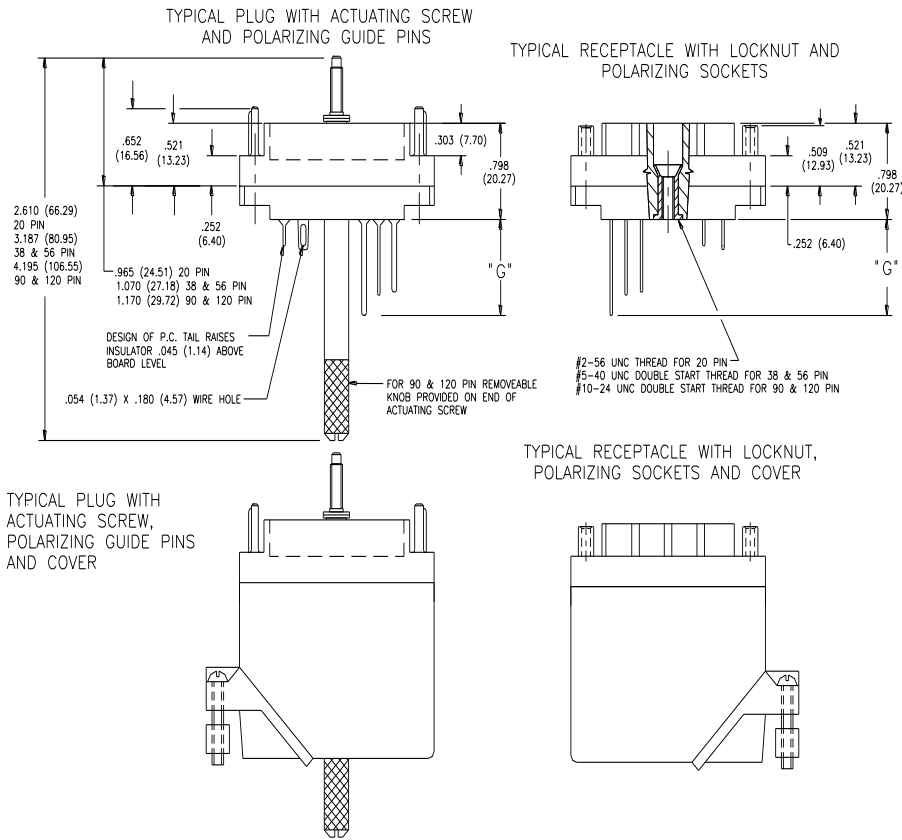

Ordering Code Notes

1) Crimp contacts are also available for 516 series connectors. Contacts may be ordered separately for pre-wired or select position assembly.

Part Number	Description	Silhouette
516-290-500	Wire Hole	
516-290-501	Taper Tail	
516-290-520	P.C. Tail	
516-290-540	Wire Wrap	
516-290-541	Wire Wrap	
516-290-542	Wire Wrap	
516-290-590	Crimp (Loose)	
516-290-591	Crimp - 1800 Contact Per Reel	

- For contact installation, removal and crimping tools, Please contact EDAC.
- Grey Polycarbonate insulator material is not available for 120 pin size connector
- The 20 pin connector cover will not accept the length of the wire wrap contacts
- Plastic covers with large clamps are only available for 38 and 56 pin sizes only
- Metal covers with side entry may be converted to top entry by removing side plate and changing clamp orientation
- Covers may be ordered separately
- Insulator design prevents improper mating of individual plug and receptacle. Polarizing hardware enables specific plug and receptacle combinations

Crimp Characteristics

- Contacts and Crimp Tool Accommodate from 28AWG to 18AWG, Solid or Stranded Conductor Diameters from .012 (0.30) to .049 (1.25) and an Insulation diameter up to 0.074 (1.88)
- Multiple Smaller Gauge Wires may be Crimped Together
- Crimp Resistance from 0.5 Milliohms (18AWG) to 1.5 Milliohms(28AWG)
- Crimp Tensile Strength for Wire Sizes

18AWG - 40 lbs (178 N)	20AWG - 25 lbs (111 N)
22AWG - 15 lbs (67 N)	24AWG - 10 lbs (44 N)
26AWG - 5 lbs (22 N)	28AWG - 3 lbs (13 N)

Polarizing Codes

- Polarizing Hardware Changes allow 288 Mating Combinations
- Standard Code Supplied for Plugs PG1G1, for Receptacle RS1S1.
- Connectors with Special Polarizing Codes Available upon Special Request

Example Polarizing Code:

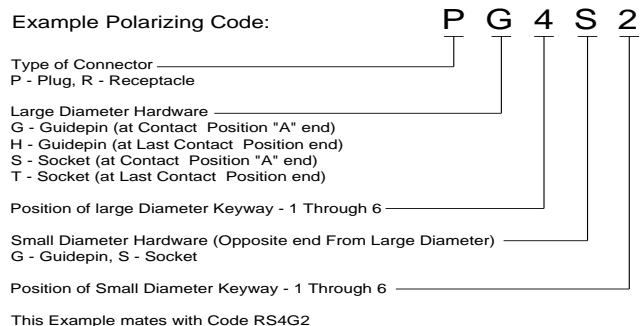

This Example mates with Code RS4G2

CONNECTOR MATING FACE VIEWS

DIMENSIONS INDICATED FOR EACH SIZE APPLY TO BOTH PLUG AND RECEPTACLE

20 PIN PLUG

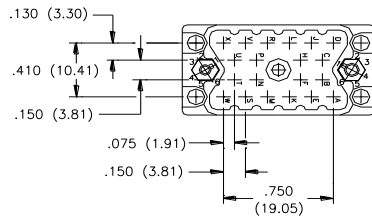

20 PIN RECEPTACLE

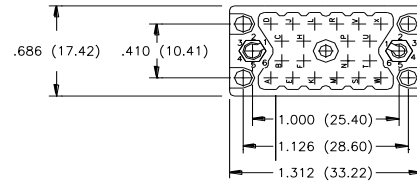

38 PIN PLUG

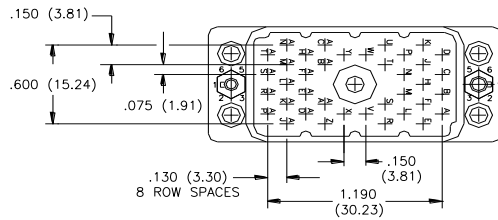

38 PIN RECEPTACLE

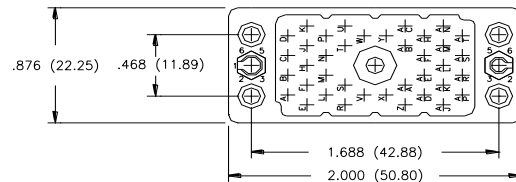

56 PIN PLUG

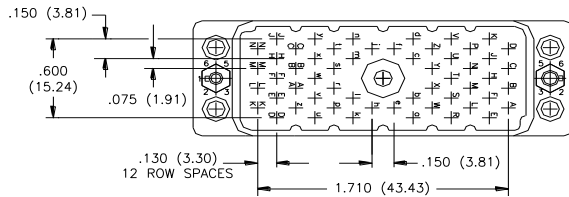

56 PIN RECEPTACLE

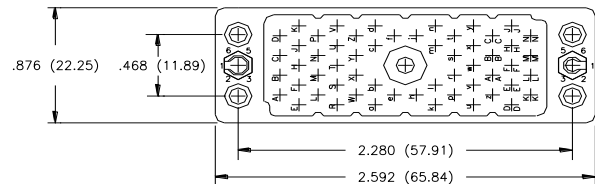

90 PIN PLUG

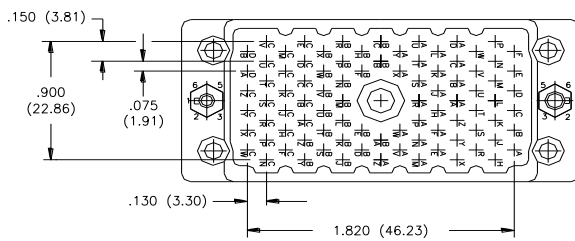

90 PIN RECEPTACLE

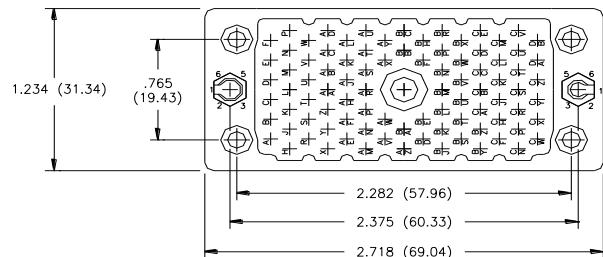

120 PIN PLUG

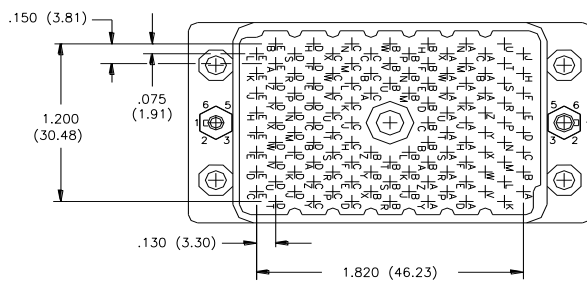

120 PIN RECEPTACLE

