

PLEASE CHECK WWW.MOLEX.COM FOR LATEST PART INFORMATION

Part Number: [5041941270](#)
Status: **Active**
Overview: [Micro-Lock™ Connectors](#)
Description: Micro-Lock 1.25mm Pitch Single-Row Vertical Header, Beige, 12 Circuits

Documents:

3D Model	Application Specification AS-504193-002-001 (PDF)
Drawing (PDF)	Packaging Specification SPK-504194-001-001 (PDF)
Product Specification PS-504193-001-001 (PDF)	RoHS Certificate of Compliance (PDF)
Application Specification AS-504193-001-001 (PDF)	

General

Product Family	PCB Headers
Series	504194
Application	Wire-to-Board
CURRENT-MAX-NUMERIC	1.5
Overview	Micro-Lock™ Connectors
PITCH-MATING-NUMERIC	1.25
Product Name	Micro-Lock
UPC	887191206066

Physical

Breakaway	No
Circuits (Loaded)	12
Circuits (maximum)	12
Color - Resin	Beige
Durability (mating cycles max)	30
First Mate / Last Break	No
Glow-Wire Capable	No
Guide to Mating Part	No
Lock to Mating Part	Yes
Material - Metal	Brass
Material - Plating Mating	Tin
Material - Plating Termination	Nickel
Net Weight	347.797/mg
Number of Rows	1
Orientation	Vertical
PC Tail Length	3.00mm
PCB Locator	No
PCB Retention	None
PCB Thickness - Recommended	1.20mm, 1.60mm
Packaging Type	Embossed Tape on Reel
Pitch - Mating Interface	1.25mm
Pitch - Termination Interface	1.25mm
Temperature Range - Operating	-25° to +85°C
Termination Interface: Style	Surface Mount

Electrical

Current - Maximum per Contact	1.5A
Voltage - Maximum	50V

Material Info

Reference - Drawing Numbers

Application Specification	AS-504193-001-001, AS-504193-002-001
Packaging Specification	SPK-504194-001-001
Product Specification	PS-504193-001-001
Sales Drawing	SD-504194-001, SD-504194-002

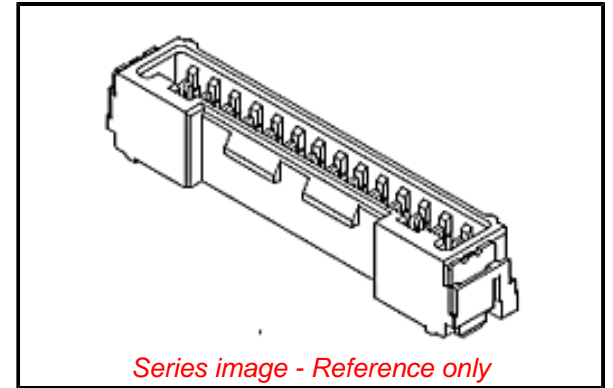

EU ELV

Not Relevant

EU RoHS

Compliant

REACH SVHC

Not Contained Per -
ED/71/2019 (16 July
2019)

Halogen-Free

Status

Not Low-Halogen

For more information, please visit [Contact US](#)

China ROHS

ELV

RoHS Phthalates

China RoHS

Green Image

Not Relevant

Not Contained

Search Parts in this Series

[504194 Series](#)

Mates With

[504193](#) Micro-Lock Wire-to-Board Crimp Housing

This document was generated on 09/04/2019

PLEASE CHECK WWW.MOLEX.COM FOR LATEST PART INFORMATION