

PLEASE CHECK WWW.MOLEX.COM FOR LATEST PART INFORMATION

Part Number: **5016451220**
Status: **Active**
Overview: iGrid™ Wire-to-Board Dual-Row System
Description: 2.00mm Pitch iGrid™ Wire-to-Board Header, Dual Row, Vertical, with PCB Locator, 12 Circuits

Documents:

3D Model	Application Specification 5016460000-A01 (PDF)
Drawing (PDF)	Packaging Specification SPK-501645-001-001 (PDF)
Product Specification PS-501646-001-001 (PDF)	RoHS Certificate of Compliance (PDF)
Application Specification 5016460000-A00 (PDF)	

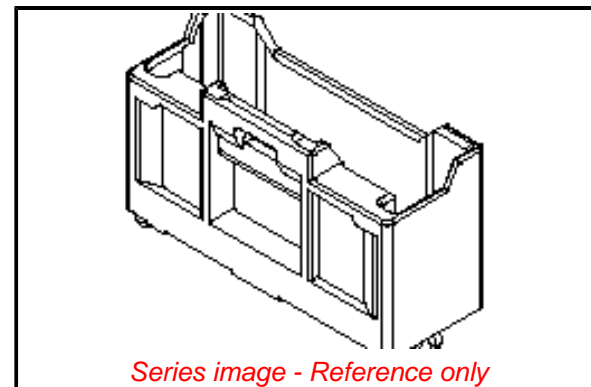

Agency Certification

UL E29179

General

Product Family	PCB Headers
Series	501645
Application	Signal, Wire-to-Board
MolexKits	Yes
Overview	iGrid™ Wire-to-Board Dual-Row System
Product Name	iGrid™
UPC	822350201308

Physical

Breakaway	No
Circuits (Loaded)	12
Circuits (maximum)	12
Color - Resin	Natural
Durability (mating cycles max)	30
Flammability	94V-0
Glow-Wire Compliant	No
Keying to Mating Part	Yes
Lock to Mating Part	Yes
Material - Metal	Brass
Material - Plating Mating	Tin
Material - Plating Termination	Tin
Material - Resin	Nylon
Net Weight	818.800/mg
Number of Rows	2
Orientation	Vertical
PC Tail Length	3.20mm
PCB Locator	Yes
PCB Retention	None
PCB Thickness - Recommended	1.20mm, 1.60mm
Packaging Type	Tray
Pitch - Mating Interface	2.00mm
Polarized to Mating Part	Yes
Polarized to PCB	Yes
Stackable	No
Surface Mount Compatible (SMC)	No
Temperature Range - Operating	-40°C to +105°C
Termination Interface: Style	Through Hole

Electrical

Current - Maximum per Contact	2.0A
Voltage - Maximum	250V AC (RMS)/DC

EU ELV

Not Relevant

EU RoHS

Compliant
REACH SVHC

Not Contained Per
-ED/01/2017 (12
January 2017)

Halogen-Free

Status

Not Low-Halogen

Need more information on product environmental compliance?

Email productcompliance@molex.com
Please visit the [Contact Us](#) section for any non-product compliance questions.

China ROHS	Green Image
ELV	Not Relevant
RoHS Phthalates	Not Contained

Search Parts in this Series

501645 Series

Mates With

501646 Housing, 501647 Crimp Terminal
22-26 AWG, 501648 Crimp Terminal 26-28
AWG

Material Info

Reference - Drawing Numbers

Application Specification	5016460000-A00, 5016460000-A01
Packaging Specification	SPK-501645-001-001
Product Specification	PS-501646-001-001
Sales Drawing	SD-501645-001

This document was generated on 07/24/2017

PLEASE CHECK WWW.MOLEX.COM FOR LATEST PART INFORMATION