

PLEASE CHECK WWW.MOLEX.COM FOR LATEST PART INFORMATION

Part Number: **5013301500**
Status: **Active**
Overview: Pico-Clasp™ Wire-to-Board Connectors
Description: 1.00mm Pitch Pico-Clasp™ Wire-to-Board Female Housing, Single Row, with Positive Lock, 15 Circuits

Documents:

3D Model	Product Specification PS-504449-001-001 (PDF)
Drawing (PDF)	Packaging Specification SPK-501330-001-001 (PDF)
Product Specification PS-501331-001-001 (PDF)	RoHS Certificate of Compliance (PDF)
Product Specification PS-501568-001-001 (PDF)	

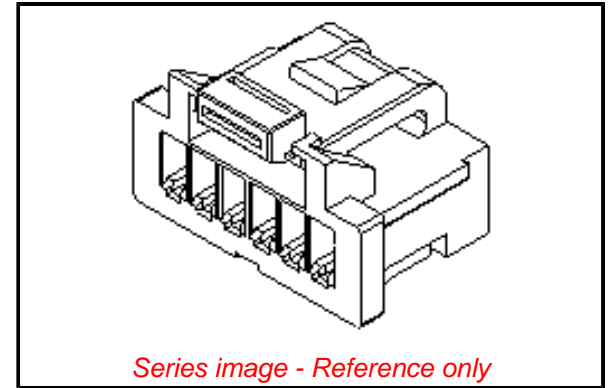

Agency Certification

UL E29179

General

Product Family	Crimp Housings
Series	501330
Application	Signal, Wire-to-Board
Overview	Pico-Clasp™ Wire-to-Board Connectors
Product Name	Pico-Clasp™
UPC	822348529001

Physical

Circuits (maximum)	15
Color - Resin	White
Gender	Receptacle
Glow-Wire Compliant	No
Lock to Mating Part	Yes
Material - Resin	Nylon
Net Weight	118.600/mg
Number of Rows	1
Packaging Type	Bag
Panel Mount	No
Pitch - Mating Interface	1.00mm
Polarized to Mating Part	Yes
Stackable	No
Temperature Range - Operating	-40°C to +105°C

Electrical

Current - Maximum per Contact 1.0A

Material Info

Reference - Drawing Numbers

Packaging Specification	SPK-501330-001-001
Product Specification	PS-501331-001-001, PS-501568-001-001, PS-504449-001-001
Sales Drawing	SD-501330-002

EU ELV

Compliant

EU RoHS

Compliant

REACH SVHC

Not Contained Per -
ED/30/2017 (7 July
2017)

Halogen-Free

Status

Low-Halogen

**Need more information on product
environmental compliance?**

Email productcompliance@molex.com
Please visit the [Contact Us](#) section for any
non-product compliance questions.

China ROHS	Green Image
ELV	Compliant
RoHS Phthalates	Not Contained

Search Parts in this Series

[501330 Series](#)

Mates With

[501331 Vertical PCB Header](#)

[501568 Right Angle PCB Header](#)

Use With

[501334 Tin Crimp Terminal](#)

[501193 Gold Crimp Terminal](#)