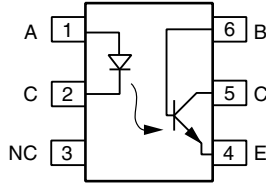
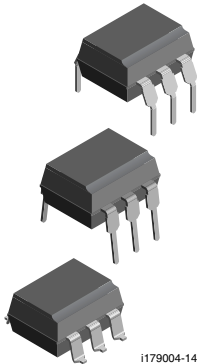

# Optocoupler, Phototransistor Output, with Base Connection

**RoHS**  
COMPLIANT

## FEATURES

- Isolation test voltage 5000 V<sub>RMS</sub>
- Interfaces with common logic families
- Input-output coupling capacitance < 0.5 pF
- Industry standard dual-in-line 6 pin package
- Compliant to RoHS Directive 2002/95/EC and in accordance to WEEE 2002/96/EC

## APPLICATIONS

- AC mains detection
- Reed relay driving
- Switch mode power supply feedback
- Telephone ring detection
- Logic ground isolation
- Logic coupling with high frequency noise rejection

## AGENCY APPROVALS

- UL file no. E52744 (pending)
- cUL tested to CSA 22.2 bulletin 5A
- DIN EN 60747-5-2 (VDE 0884)/DIN EN 60747-5-5 (pending), available with option 1
- BSI: EN 60065, EN 60950-1
- FIMKO
- CQC

## DESCRIPTION

This datasheet presents five families of Vishay industry standard single channel phototransistor couplers. These families include the 4N35, 4N36, 4N37, 4N38 couplers.

Each optocoupler consists of gallium arsenide infrared LED and a silicon NPN phototransistor.

These couplers are Underwriters Laboratories (UL) listed to comply with a 5000 V<sub>RMS</sub> isolation test voltage.

This isolation performance is accomplished through Vishay double molding isolation manufacturing process. Compliance to DIN EN 60747-5-5 partial discharge isolation specification is available for these families by ordering option 1.

These isolation processes and the Vishay ISO9001 quality program results in the highest isolation performance available for a commercial plastic phototransistor optocoupler.

The devices are available in lead formed configuration suitable for surface mounting and are available either on tape and reel, or in standard tube shipping containers.

### Note

- For additional design information see application note 45 normalized curves

ORDERING INFORMATION				
4	N	3	x	-
PART NUMBER				X
				0
				#
				#
				T
				T TAPE AND REEL
		DIP-6	Option 6	
		7.62 mm	10.16 mm	
		Option 7	Option 9	
		> 8 mm	8 mm typ.	
AGENCY CERTIFIED/PACKAGE	CTR (%)			
	10 mA		20 mA	
<b>UL, cUL, BSI, FIMKO</b>	<b>≥ 100</b>		<b>≥ 20</b>	
DIP-6	4N35-X000	4N36-X000	4N37-X000	4N38
DIP-6, 400 mil, option 6	4N35-X006	-	4N37-X006	-
SMD-6, option 7	4N35-X007T <sup>(1)</sup>	4N36-X007	4N37-X007	4N38-X007T <sup>(1)</sup>
SMD-6, option 9	4N35-X009T <sup>(1)</sup>	4N36-X009T <sup>(1)</sup>	4N37-X009	4N38-X009T
<b>VDE, UL, cUL, BSI, FIMKO</b>	<b>≥ 100</b>		<b>≥ 20</b>	
DIP-6	4N35-X001	-	4N37-X001	-
DIP-6, 400 mil, option 6	4N35-X016	-	-	-
SMD-6, option 7	4N35-X017T <sup>(1)</sup>	-	-	-
SMD-6, option 9	4N35-X019T	-	-	-

### Notes

- Additional options may be possible, please contact sales office.
- (1) Also available in tubes; do not put T on end.



<b>ABSOLUTE MAXIMUM RATINGS</b> ( $T_{amb} = 25\text{ }^{\circ}\text{C}$ , unless otherwise specified)				
PARAMETER	TEST CONDITION	SYMBOL	VALUE	UNIT
<b>INPUT</b>				
Reverse voltage		$V_R$	6	V
Forward current		$I_F$	60	mA
Surge current	$t \leq 10\text{ }\mu\text{s}$	$I_{FSM}$	2.5	A
Power dissipation		$P_{diss}$	70	mW
<b>OUTPUT</b>				
Collector emitter breakdown voltage		$V_{CEO}$	70	V
Emitter base breakdown voltage		$V_{EBO}$	7	V
Collector current		$I_C$	50	mA
Collector peak current	$t_p/T = 0.5, t_p \leq 10\text{ ms}$	$I_{CM}$	100	mA
Output power dissipation		$P_{diss}$	150	mW
<b>COUPLER</b>				
Isolation test voltage	$t = 1\text{ s}$	$V_{ISO}$	5000	$V_{RMS}$
Creepage distance			$\geq 7$	mm
Clearance distance			$\geq 7$	mm
Isolation thickness between emitter and detector			$\geq 0.4$	mm
Comparative tracking index	DIN IEC 112/VDE 0303, part 1		$\geq 175$	
Isolation resistance	$V_{IO} = 500\text{ V}, T_{amb} = 25\text{ }^{\circ}\text{C}$	$R_{IO}$	$\geq 10^{12}$	$\Omega$
	$V_{IO} = 500\text{ V}, T_{amb} = 100\text{ }^{\circ}\text{C}$	$R_{IO}$	$\geq 10^{11}$	$\Omega$
Storage temperature		$T_{stg}$	- 55 to + 150	$^{\circ}\text{C}$
Operating temperature		$T_{amb}$	- 55 to + 100	$^{\circ}\text{C}$
Soldering temperature <sup>(1)</sup>	2 mm from case, $\leq 10\text{ s}$	$T_{sld}$	260	$^{\circ}\text{C}$

**Notes**

- Stresses in excess of the absolute maximum ratings can cause permanent damage to the device. Functional operation of the device is not implied at these or any other conditions in excess of those given in the operational sections of this document. Exposure to absolute maximum ratings for extended periods of the time can adversely affect reliability.
- <sup>(1)</sup> Refer to reflow profile for soldering conditions for surface mounted devices (SMD). Refer to wave profile for soldering conditions for through hole devices (DIP).

<b>ELECTRICAL CHARACTERISTICS</b> ( $T_{amb} = 25\text{ }^{\circ}\text{C}$ , unless otherwise specified)							
PARAMETER	TEST CONDITION	PART	SYMBOL	MIN.	TYP.	MAX.	UNIT
<b>INPUT</b>							
Forward voltage <sup>(1)</sup>	$I_F = 10\text{ mA}$		$V_F$		1.2	1.5	V
	$I_F = 10\text{ mA}, T_{amb} = - 55\text{ }^{\circ}\text{C}$		$V_F$	0.9	1.3	1.7	V
Reverse current <sup>(1)</sup>	$V_R = 6\text{ V}$		$I_R$		0.1	10	$\mu\text{A}$
Capacitance	$V_R = 0\text{ V}, f = 1\text{ MHz}$		$C_O$		25		pF
<b>OUTPUT</b>							
Collector emitter breakdown voltage <sup>(1)</sup>	$I_C = 1\text{ mA}$	4N35	$BV_{CEO}$	30			V
		4N36	$BV_{CEO}$	30			V
		4N37	$BV_{CEO}$	30			V
		4N38	$BV_{CEO}$	80			V
Emitter collector breakdown voltage <sup>(1)</sup>	$I_E = 100\text{ }\mu\text{A}$		$BV_{ECO}$	7			V
Collector base breakdown voltage <sup>(1)</sup>	$I_C = 100\text{ }\mu\text{A}, I_B = 1\text{ }\mu\text{A}$	4N35	$BV_{CBO}$	70			V
		4N36	$BV_{CBO}$	70			V
		4N37	$BV_{CBO}$	70			V
		4N38	$BV_{CBO}$	80			V

<b>ELECTRICAL CHARACTERISTICS</b> ( $T_{amb} = 25\text{ }^{\circ}\text{C}$ , unless otherwise specified)								
PARAMETER	TEST CONDITION	PART	SYMBOL	MIN.	TYP.	MAX.	UNIT	
<b>OUTPUT</b>								
Collector emitter leakage current <sup>(1)</sup>	$V_{CE} = 10\text{ V}, I_F = 0$	4N35	$I_{CEO}$		5	50	nA	
		4N36	$I_{CEO}$		5	50	nA	
	$V_{CE} = 10\text{ V}, I_F = 0$	4N37	$I_{CEO}$		5	50	nA	
	$V_{CE} = 60\text{ V}, I_F = 0$	4N38	$I_{CEO}$			50	nA	
	$V_{CE} = 30\text{ V}, I_F = 0,$ $T_{amb} = 100\text{ }^{\circ}\text{C}$		4N35	$I_{CEO}$			500	$\mu\text{A}$
			4N36	$I_{CEO}$			500	$\mu\text{A}$
		4N37	$I_{CEO}$			500	$\mu\text{A}$	
	$V_{CE} = 60\text{ V}, I_F = 0,$ $T_{amb} = 100\text{ }^{\circ}\text{C}$	4N38	$I_{CEO}$		6		$\mu\text{A}$	
Collector emitter capacitance	$V_{CE} = 0$		$C_{CE}$		6		pF	
<b>coupler</b>								
Resistance, input output <sup>(1)</sup>	$V_{IO} = 500\text{ V}$		$R_{IO}$	$10^{11}$			$\Omega$	
Capacitance, input output	$f = 1\text{ MHz}$		$C_{IO}$		0.5		pF	

**Notes**

- Minimum and maximum values are testing requirements. Typical values are characteristics of the device and are the result of engineering evaluation. Typical values are for information only and are not part of the testing requirements.
- <sup>(1)</sup> Indicates JEDEC registered value.

<b>CURRENT TRANSFER RATIO</b> ( $T_{amb} = 25\text{ }^{\circ}\text{C}$ , unless otherwise specified)								
PARAMETER	TEST CONDITION	PART	SYMBOL	MIN.	TYP.	MAX.	UNIT	
$I_C/I_F$ <sup>(1)</sup>	$V_{CE} = 10\text{ V}, I_F = 10\text{ mA}$	4N35	$CTR_{DC}$	100			%	
		4N36	$CTR_{DC}$	100			%	
		4N37	$CTR_{DC}$	100			%	
	$V_{CE} = 10\text{ V}, I_F = 20\text{ mA}$	4N38	$CTR_{DC}$	20			%	
	$V_{CE} = 10\text{ V}, I_F = 10\text{ mA},$ $T_A = -55\text{ }^{\circ}\text{C to } +100\text{ }^{\circ}\text{C}$		4N35	$CTR_{DC}$	40	50		%
			4N36	$CTR_{DC}$	40	50		%
		4N37	$CTR_{DC}$	40	50		%	
		4N38	$CTR_{DC}$		30		%	

**Note**

- <sup>(1)</sup> Indicates JEDEC registered values.

<b>SWITCHING CHARACTERISTICS</b> ( $T_{amb} = 25\text{ }^{\circ}\text{C}$ , unless otherwise specified)							
PARAMETER	TEST CONDITION	SYMBOL	MIN.	TYP.	MAX.	UNIT	
Turn-on time <sup>(1)</sup>	$V_{CC} = 5\text{ V}, I_C = 2\text{ mA}, R_L = 100\text{ }\Omega$	$t_{on}$		10		$\mu\text{s}$	
Turn-off time <sup>(1)</sup>	$V_{CC} = 5\text{ V}, I_C = 2\text{ mA}, R_L = 100\text{ }\Omega$	$t_{off}$		10		$\mu\text{s}$	

**Note**

- <sup>(1)</sup> Indicates JEDEC registered values.

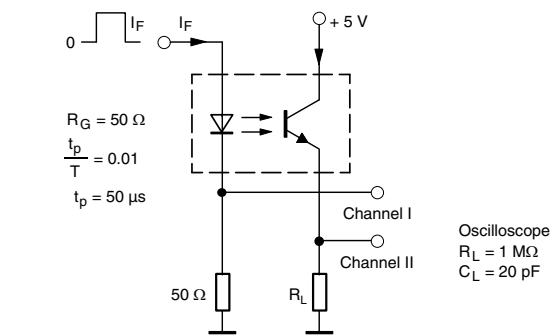

Fig. 1 - Test Circuit, Non-Saturated Operation

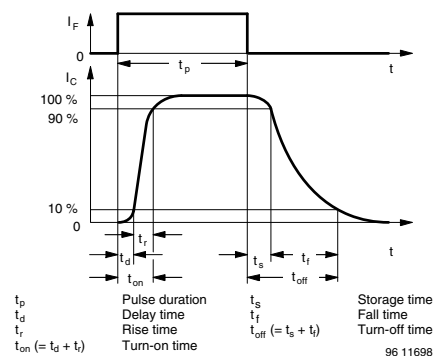

Fig. 2 - Switching Times

**TYPICAL CHARACTERISTICS** ( $T_{amb} = 25\text{ }^{\circ}\text{C}$ , unless otherwise specified)

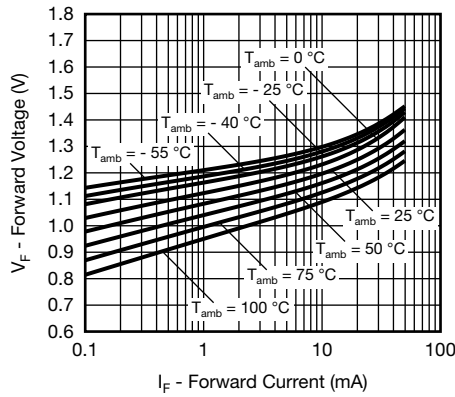

Fig. 3 - Forward Voltage vs. Forward Current

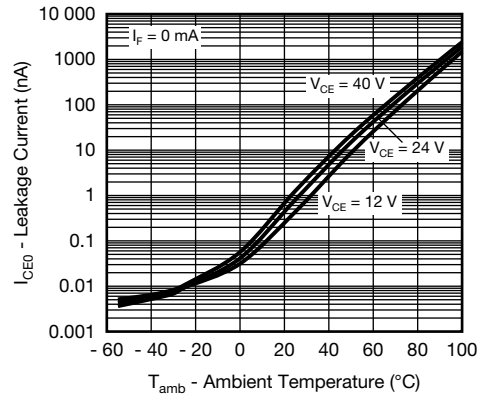

Fig. 6 - Leakage Current vs. Ambient Temperature

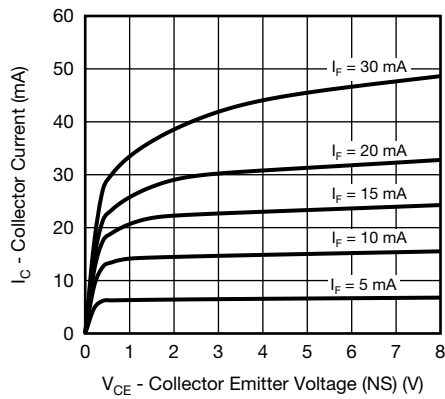

Fig. 4 - Collector Current vs. Collector Emitter Voltage (NS)

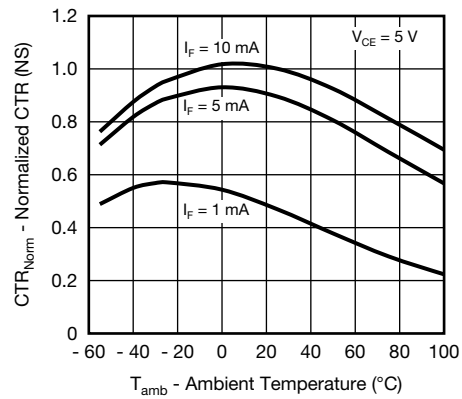

Fig. 7 - Normalized CTR (NS) vs. Ambient Temperature

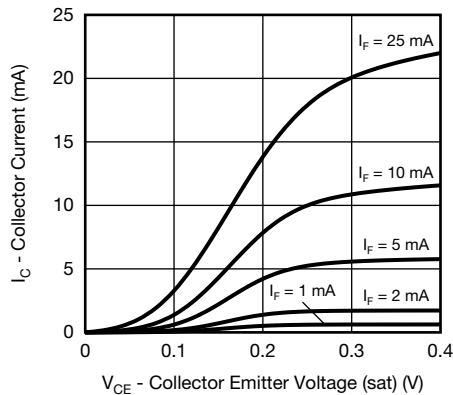

Fig. 5 - Collector Current vs. Collector Emitter Voltage (sat)

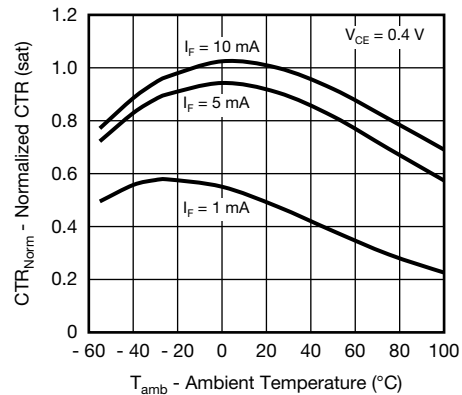

Fig. 8 - Normalized CTR (sat) vs. Ambient Temperature

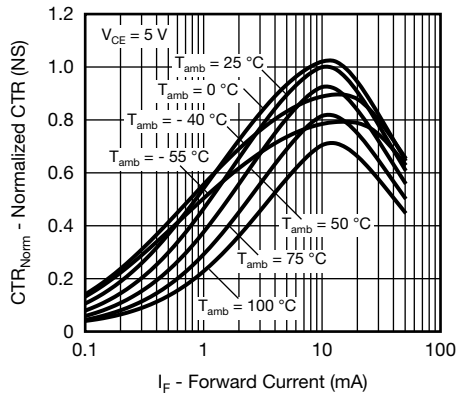

Fig. 9 - Normalized CTR (NS) vs. Forward Current

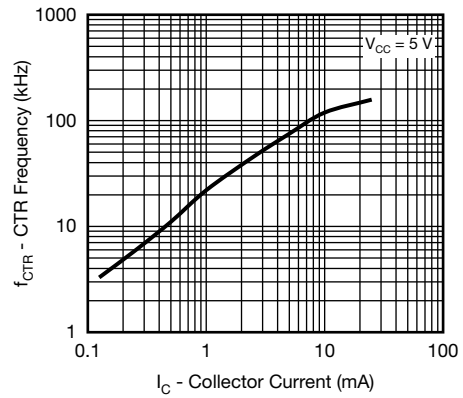

Fig. 12 - CTR Frequency vs. Collector Current

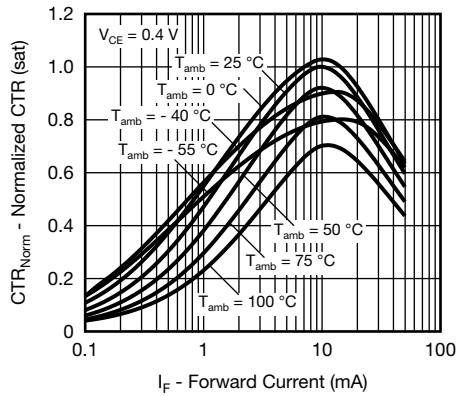

Fig. 10 - Normalized CTR (sat) vs. Forward Current

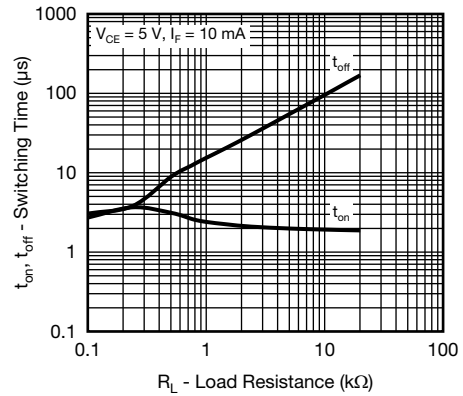

Fig. 13 - Switching Time vs. Load Resistance

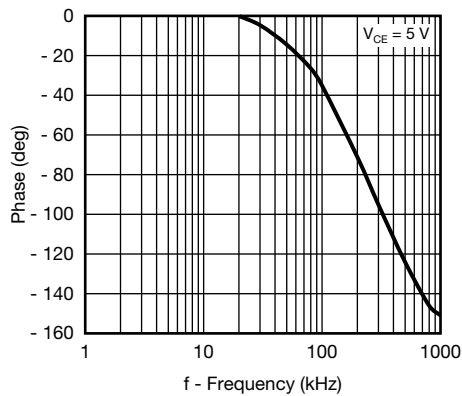
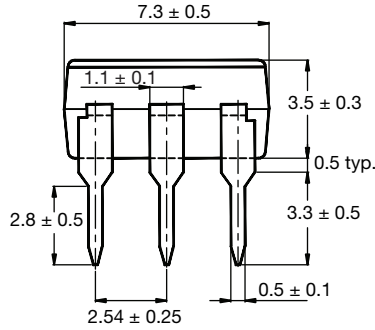
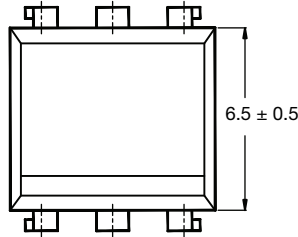

Fig. 11 - CTR Frequency vs. Phase Angle



PACKAGE DIMENSIONS in millimeters



22530

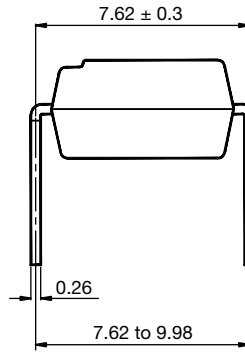

Option 6

Option 7

Option 9

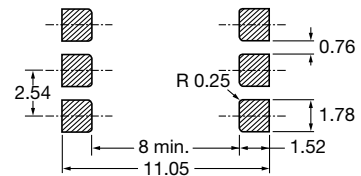
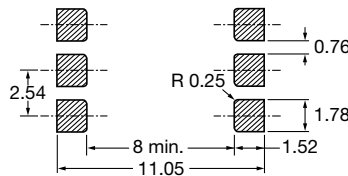
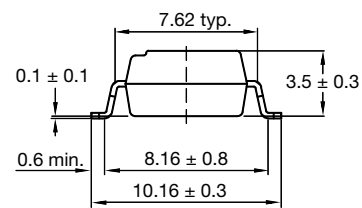
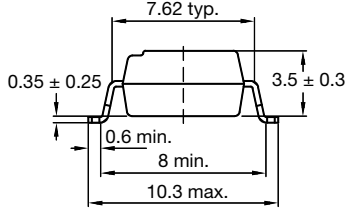
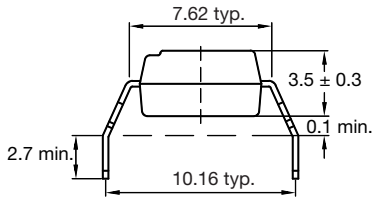

20802-34

PACKAGE MARKING

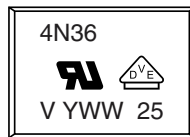

Notes

- VDE logo is only marked on option 1 parts. Option information is not marked on the part.
- Tape and reel suffix (T) is not part of the package marking.



## Disclaimer

ALL PRODUCT, PRODUCT SPECIFICATIONS AND DATA ARE SUBJECT TO CHANGE WITHOUT NOTICE TO IMPROVE RELIABILITY, FUNCTION OR DESIGN OR OTHERWISE.

Vishay Intertechnology, Inc., its affiliates, agents, and employees, and all persons acting on its or their behalf (collectively, "Vishay"), disclaim any and all liability for any errors, inaccuracies or incompleteness contained in any datasheet or in any other disclosure relating to any product.

Vishay makes no warranty, representation or guarantee regarding the suitability of the products for any particular purpose or the continuing production of any product. To the maximum extent permitted by applicable law, Vishay disclaims (i) any and all liability arising out of the application or use of any product, (ii) any and all liability, including without limitation special, consequential or incidental damages, and (iii) any and all implied warranties, including warranties of fitness for particular purpose, non-infringement and merchantability.

Statements regarding the suitability of products for certain types of applications are based on Vishay's knowledge of typical requirements that are often placed on Vishay products in generic applications. Such statements are not binding statements about the suitability of products for a particular application. It is the customer's responsibility to validate that a particular product with the properties described in the product specification is suitable for use in a particular application. Parameters provided in datasheets and/or specifications may vary in different applications and performance may vary over time. All operating parameters, including typical parameters, must be validated for each customer application by the customer's technical experts. Product specifications do not expand or otherwise modify Vishay's terms and conditions of purchase, including but not limited to the warranty expressed therein.

Except as expressly indicated in writing, Vishay products are not designed for use in medical, life-saving, or life-sustaining applications or for any other application in which the failure of the Vishay product could result in personal injury or death. Customers using or selling Vishay products not expressly indicated for use in such applications do so at their own risk. Please contact authorized Vishay personnel to obtain written terms and conditions regarding products designed for such applications.

No license, express or implied, by estoppel or otherwise, to any intellectual property rights is granted by this document or by any conduct of Vishay. Product names and markings noted herein may be trademarks of their respective owners.

## Material Category Policy

**Vishay Intertechnology, Inc. hereby certifies that all its products that are identified as RoHS-Compliant fulfill the definitions and restrictions defined under Directive 2011/65/EU of The European Parliament and of the Council of June 8, 2011 on the restriction of the use of certain hazardous substances in electrical and electronic equipment (EEE) - recast, unless otherwise specified as non-compliant.**

**Please note that some Vishay documentation may still make reference to RoHS Directive 2002/95/EC. We confirm that all the products identified as being compliant to Directive 2002/95/EC conform to Directive 2011/65/EU.**

**Vishay Intertechnology, Inc. hereby certifies that all its products that are identified as Halogen-Free follow Halogen-Free requirements as per JEDEC JS709A standards. Please note that some Vishay documentation may still make reference to the IEC 61249-2-21 definition. We confirm that all the products identified as being compliant to IEC 61249-2-21 conform to JEDEC JS709A standards.**