

Commercial Linear Motion Carbon Composition Slide Potentiometer

Features

- 10-60mm slider travel
- Innovative AC power switch (SPST, SPDT)
- Center detent available
- Single or dual element designs
- Economical
- Wide resistance range
- Slim construction
- RoHS Compliant

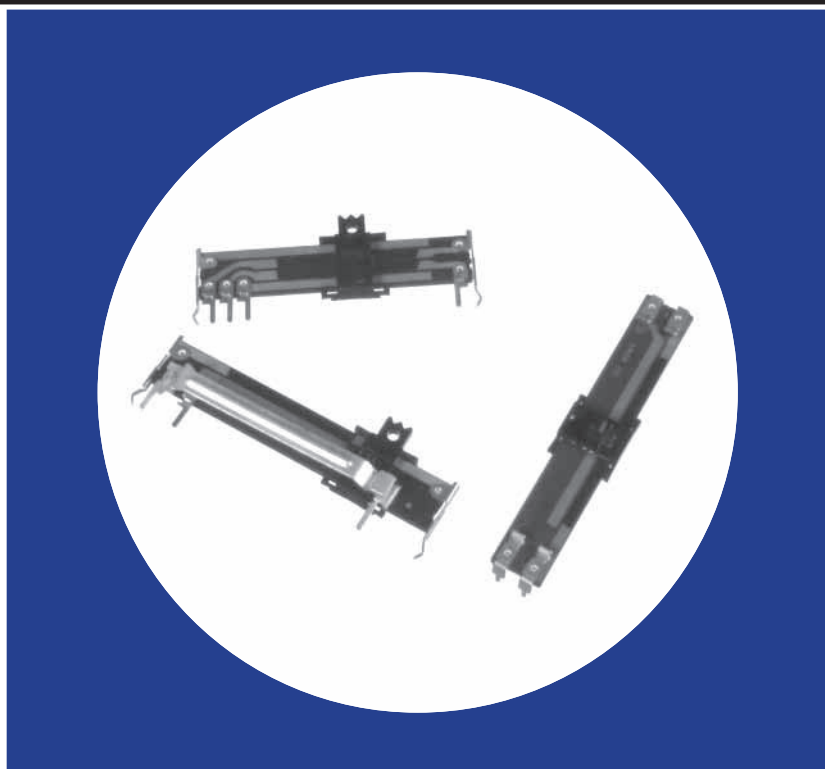

Patent No.: US: 5,959,525 , Taiwan: 204502.

Electrical and Mechanical Specifications

Resistance Range

500 ohms through 1 megohms, linear
Consult CTS for audio taper

Resistance Tolerance

±30%, ±20%, ±10%

Insulation Resistance

10 Megohms minimum at 250 VDC

Maximum Operating Voltage

Taper	10mm	15mm 20mm	30mm	45mm	60mm
Linear	100VDC	150VDC 200VDC	250VDC	300VDC	500VDC
Non-linear	50VDC	50VDC 150VDC	200VDC	250VDC	300VDC

Power Rating, watts

Taper	10mm	15mm 20mm	30mm	45mm	60mm
Linear	0.05w	0.1w	0.2w	0.25w	0.5w
Non-linear	0.025w	0.05w	0.1w	0.15w	0.25w

Power Switch (optional)

SPST - 10,000 cycles carrying 1,000 watts 120 VAC
(Tungsten-filament)

SPDT - 10,000 cycles carrying 600 watts 120 VAC
(Tungsten-filament)

Slide Travel

Potentiometer without switch:

X and U Style: 10, 15, 20, 30, 45, and 60mm

V Style: 10, 15, 25, 40, and 55mm

Potentiometer with switch:

30mm = 27mm electrical + 3mm switch (SPST only)

20mm = 17mm electrical + 3mm switch

Operating Force

Potentiometer : 20-150 g

Switch : 100-500 g

Stop Strength

3K gf maximum, measured at base of slider

Operating Life

Standard : 10,000 cycles

Special : 100,000 , 250,000 cycles

TYPE 448V MONO

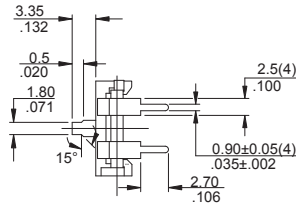
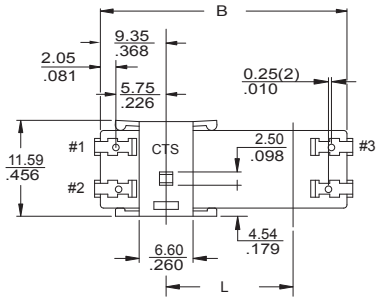
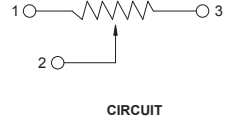
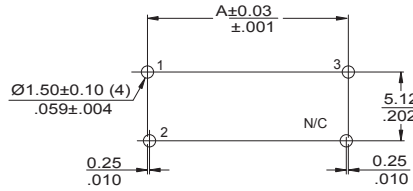
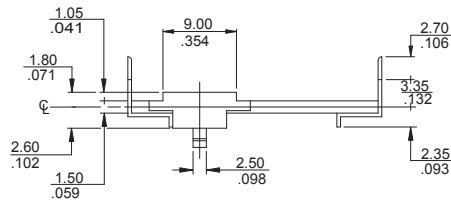

MODEL	DIMENSIONS		
	L (Travel)	A	B
448V-10M	10/ .394	30.20/1.189	28.70/1.130
448V-15M	15/ .591	35.20/1.387	33.70/1.372
448V-25M	25/ .984	45.20/1.180	43.70/1.721
448V-40M	40/ 1.575	60.20/2.370	58.70/2.311
448V-55M	55/ 2.166	75.20/2.961	73.70/2.902

DIMENSION: mm
INCH

TYPE 448U MONO

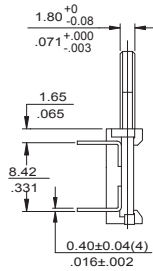
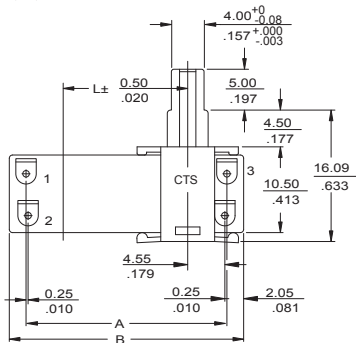
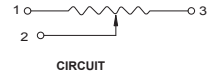
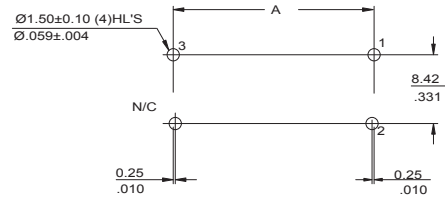
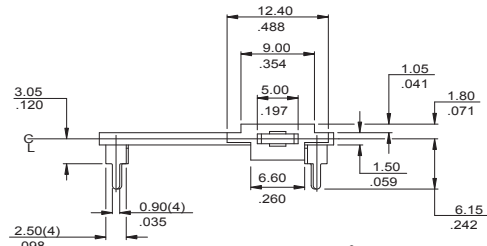

MODEL	DIMENSIONS		
	L (Travel)	A	B
448U-10M	10/ .394	19.60/ .772	23.70/ .933
448U-15M	15/ .591	24.60/ .969	28.70/1.130
448U-20M	20/ .787	29.60/1.165	33.70/1.327
448U-30M	30/ 1.181	39.60/1.559	43.70/1.720
448U-45M	45/ 1.772	54.60/2.149	58.70/2.311
448U-60M	60/ 2.362	69.60/2.740	73.70/2.902

DIMENSION: mm
INCH

TYPE 448U DUAL

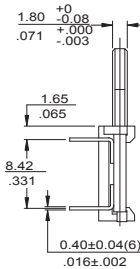
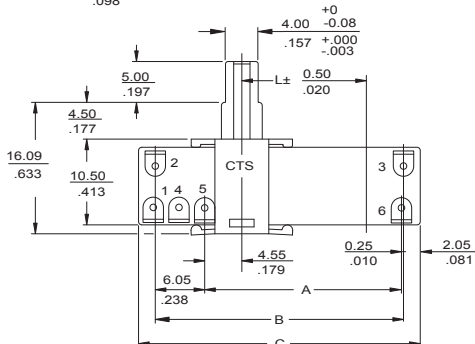
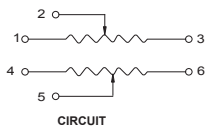
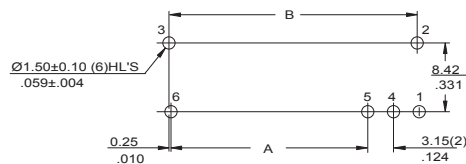
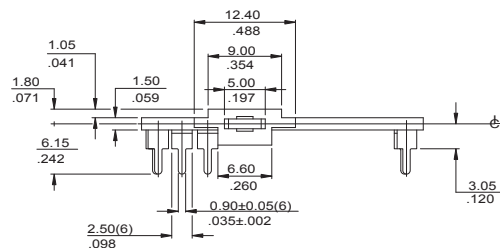

MODEL	DIMENSIONS			
	L (Travel)	A	B	C
448U-20D	20/ .787	29.10/1.146	35.40/1.394	39.50/1.555
448U-30D	30/ 1.181	39.10/1.539	45.40/1.787	49.50/1.949
448U-45D	45/ 1.772	54.10/2.130	60.40/2.378	64.50/2.539

DIMENSION: mm
INCH

TYPE 448X MONO

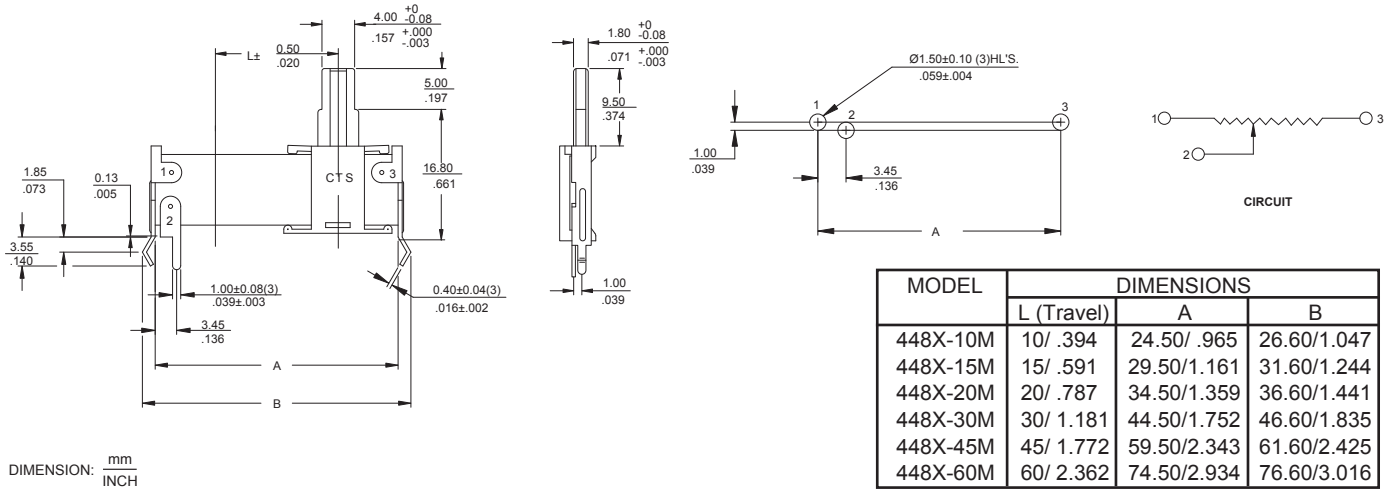

TYPE 448X DUAL

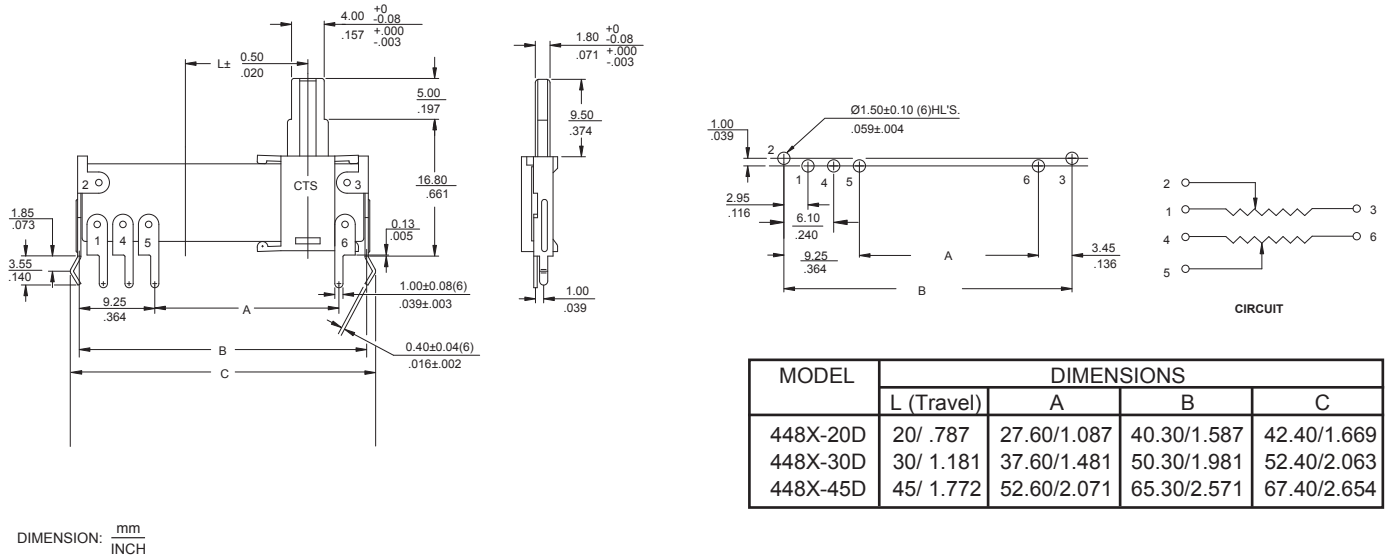

TYPE 448X MONO W/SPST SWITCH

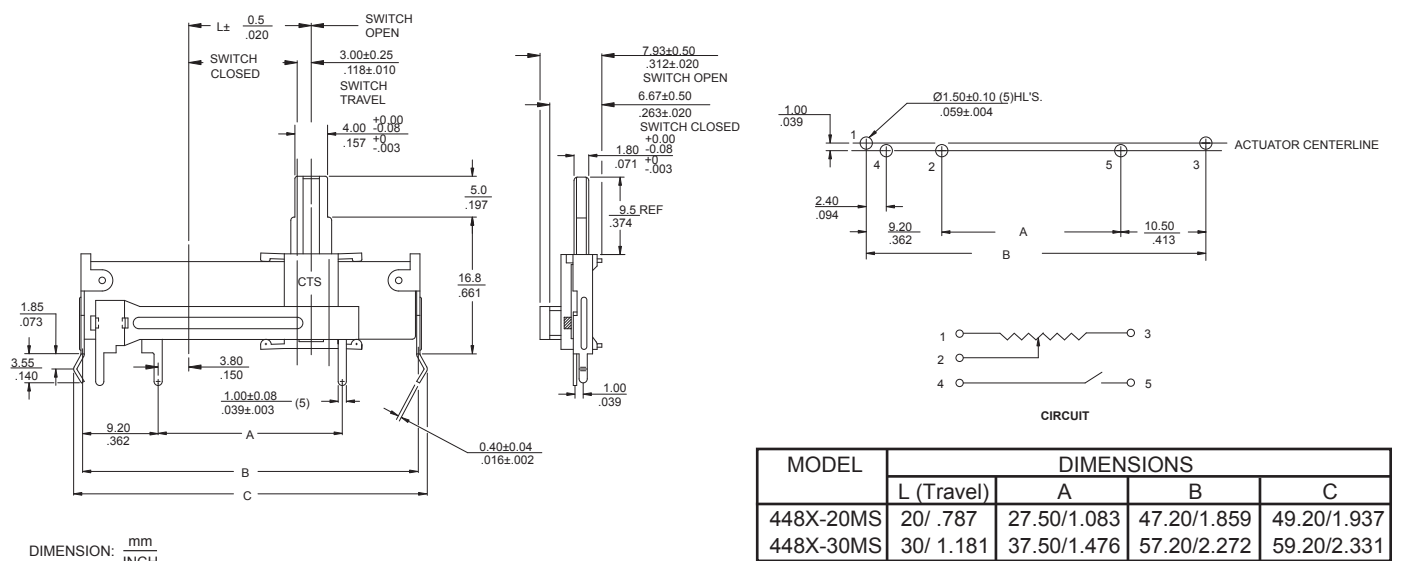

TYPE 448X MONO W/SPDT SWITCH (with style A actuator only)

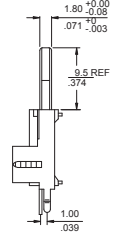
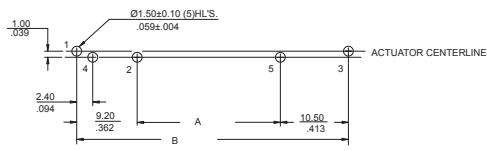

DIMENSION: $\frac{\text{mm}}{\text{INCH}}$

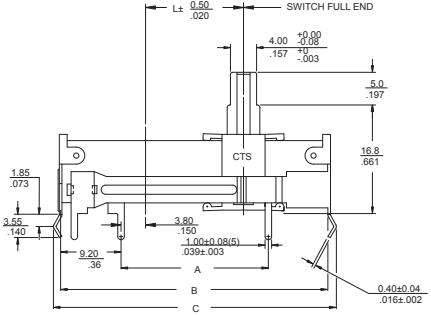
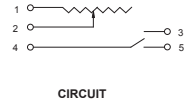

MODEL	DIMENSIONS			
	L (Travel)	A	B	C
448X-20MS	20/ .787	27.50/1.083	47.20/1.859	49.20/1.937

448 Series Actuator Styles

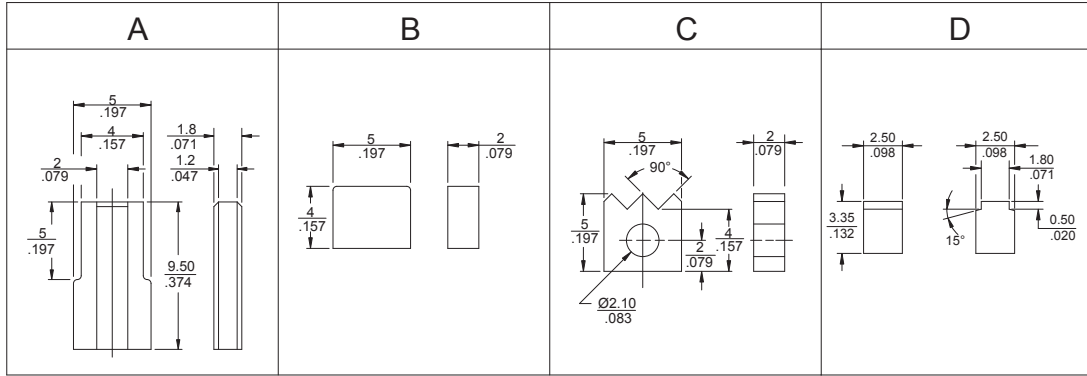

Ordering Information

<p>448</p> <div style="border: 1px solid black; padding: 5px; margin-top: 10px;"> <p style="text-align: center; margin: 0;">MOUNTING STYLE</p> <p>U- ACTUATOR PARALLEL TO PC BOARD X- ACTUATOR PERPENDICULAR TO PC BOARD V- ACTUATOR (Low Profile) PERPENDICULAR TO PCB (mono only)</p> </div>	<p>U</p> <div style="border: 1px solid black; padding: 5px; margin-top: 10px;"> <p style="text-align: center; margin: 0;">TRAVEL</p> <p>U & X TYPES V-TYPE A- 10mm A- 10mm B- 15mm B- 15mm C- 20mm C- 25mm D- 30mm D- 40mm E- 45mm E- 55mm F- 60mm</p> </div>	<p>2</p> <div style="border: 1px solid black; padding: 5px; margin-top: 10px;"> <p style="text-align: center; margin: 0;">ACTUATOR STYLE</p> <p>U & X TYPES V-TYPE 2- STYLE A: 9.5mm 1- STYLE D: 3.35mm 3- STYLE B: 4.0mm 4- STYLE C: 5.0mm</p> </div>	<p>102</p> <div style="border: 1px solid black; padding: 5px; margin-top: 10px;"> <p style="text-align: center; margin: 0;">RESISTANCE CODE (EXAMPLES)</p> <table style="width: 100%; border-collapse: collapse;"> <thead> <tr> <th style="text-align: left;">CODE</th> <th style="text-align: left;">RESISTANCE</th> </tr> </thead> <tbody> <tr><td>501</td><td>500 ohms</td></tr> <tr><td>102</td><td>1K</td></tr> <tr><td>252</td><td>2.5K</td></tr> <tr><td>502</td><td>5K</td></tr> <tr><td>103</td><td>10K</td></tr> <tr><td>253</td><td>25K</td></tr> <tr><td>503</td><td>50K</td></tr> <tr><td>104</td><td>100K</td></tr> </tbody> </table> </div>	CODE	RESISTANCE	501	500 ohms	102	1K	252	2.5K	502	5K	103	10K	253	25K	503	50K	104	100K	<p>B</p> <div style="border: 1px solid black; padding: 5px; margin-top: 10px;"> <p style="text-align: center; margin: 0;">RESISTANCE TOLERANCE</p> <p>A- ±10% B- ±20% C- ±30%</p> </div>	<p>D</p> <div style="border: 1px solid black; padding: 5px; margin-top: 10px;"> <p style="text-align: center; margin: 0;">TAPER</p> <p>D- LINEAR A- CW 10% AUDIO B- CCW 10% AUDIO</p> </div>	<p>N</p> <div style="border: 1px solid black; padding: 5px; margin-top: 10px;"> <p style="text-align: center; margin: 0;">SPECIALS</p> <p>N- NO SPECIALS C- CENTER DETENT S- SPST POWER SWITCH (20 & 30mm, X type only) D- SPDT POWER SWITCH (20 mm, X type and 9.5mm actuator only)</p> </div>
CODE	RESISTANCE																							
501	500 ohms																							
102	1K																							
252	2.5K																							
502	5K																							
103	10K																							
253	25K																							
503	50K																							
104	100K																							

Consult CTS for dual resistance element, customized, or not listed features.