

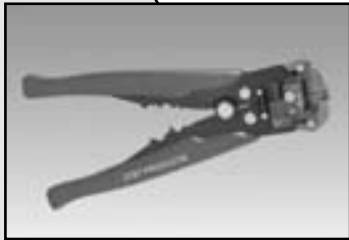

**wiring accessories**  
MASTER CATALOG



# vision

*Our over-reaching team goal*

To be recognized by our customers as the best merchandiser of electrical wiring accessories on the planet.

# purpose

*Reason for existence*

To create eternal relationships, internally and externally, through excellent service and product quality

# values

*Our fundamental beliefs that guide all actions and decisions.*

- ◆ Mutual respect, because people are number one.
- ◆ Utmost honesty, integrity and ethical behavior as the foundation for all relationships.
- ◆ Continuous and persistent improvements in all areas.
- ◆ Commitment to serving both internal and external customers.



285 East Parr Blvd, Reno, NV 89512-1003  
sales@thebestconnection.com JTTProducts.com  
Toll free 800-633-3655 Fax 775-322-7477

## **Our JT&T Brand**

For over 25 years, our products have been distributed under the JT&T brand for use in numerous industries, including automotive, HVAC/R, electronics, OEM, audio & video and retail store applications.

## **Merchandising Versatility**

A Leader in innovative, high-quality display merchandising, our displays provide high-volume sales of 100's of products in over 30 product categories utilizing minimal space. Field proven products and packaging makes JT&T products a must for your wire accessories product mix.

## **Private Label Alliances**

Our packaging design and production capability gives us the ability to tailor-make and implement marketing strategies at reasonable cost while maximizing company brand awareness.

## **Long-term Partnerships**

We are committed to building long-term relationships. Our desire is to create partnerships with our customers and provide the highest quality products at very competitive prices and excellent customer service.

**C  
O  
N  
T  
E  
N  
T  
S**

<b>Terminals</b>	<b>Pg 1 - 9</b>
<b>Heavy - Duty Terminals / Lugs</b>	<b>Pg 2</b>
<b>High Temperature Terminals</b>	<b>Pg 4</b>
<b>Disconnects</b>	<b>Pg 3 - 5</b>
<b>Twist Connects / Taps</b>	<b>Pg 5 - 6</b>

<b>OEM Connectors / Weather Packs</b>	<b>Pg 8 - 9</b>
<b>Terminal Kits and Boxes / Wire Tie Kits</b>	<b>Pg 10 -12</b>
<b>Primary Wire / Motor Wire</b>	<b>Pg 13</b>
<b>Fusible Link Wire</b>	<b>Pg 12, 14</b>
<b>Fuses and Fuse Accessories</b>	<b>Pg 15 - 16</b>

<b>Trailer Products and Accessories</b>	<b>Pg 17 - 18</b>
<b>Automotive Light Sockets and Pigtails</b>	<b>Pg 19 - 28</b>
<b>Automotive Repair Harnesses &amp; Service Connectors</b>	<b>Pg 19 - 28</b>
<b>Toggle / Rocker Switches &amp; Accessories</b>	<b>Pg 29 - 31</b>
<b>Heat Shrink Spools and Sticks</b>	<b>Pg 32 - 34</b>
<b>Expandable Sleeving</b>	<b>Pg 35</b>

<b>Flex - Guard Convoluted Tubing / Spiral Wrap Fabric Loom</b>	<b>Pg 35 - 36</b>
<b>Grommets &amp; Radiator Tie - Downs / Cable Tie Tools</b>	<b>Pg 36 - 38</b>
<b>Cable Ties &amp; Accessories</b>	<b>Pg 37 - 38</b>
<b>Nylon &amp; Insulated Clamps</b>	<b>Pg 38 - 39</b>
<b>Test Leads &amp; Clamps</b>	<b>Pg 39</b>
<b>Crimpers, Strippers &amp; Electrical Testers</b>	<b>Pg 40</b>

<b>Vacuum Caps - Windshield Washer Fitting</b>	<b>Pg 41</b>
<b>Automotive Accessories</b>	<b>Pg 42</b>
<b>Merchandising Displays</b>	<b>Pg 43 - 45</b>
<b>High Performance Expandable Sleeving / Kits</b>	<b>Pg 46</b>
<b>Index by Part Number</b>	<b>Pg 47 - 50</b>

<b>New Products</b>	<b>Pg 51 - 52</b>
---------------------	-------------------





Ordering is easy!  
Electronic Data Interchange  
Phone, Fax, Email

## Non-Insulated Rings



Stud	22-18AWG		16-14AWG		12-10AWG	
	Part #	Pcs	Part #	Pcs	Part #	Pcs
6	1000C	100	1006C	100	1012C	100
	1000H	25	1006H	25	1012H	25
8	1001C	100	1007C	100	1013C	100
	1001H	25	1007H	25	1013H	25
10	1002C	100	1008C	100	1014C	100
	1002H	35	1008H	25	1014H	25
1/4	1003H	25	1009C	100	1015C	100
	--	--	1009H	25	1015H	25
5/16	1004C	100	1010C	100	1016C	100
	1004H	25	1010H	25	1016H	25
3/8	1005H	25	1011C	100	1017C	100
	--	--	1011H	25	1017H	25

## Nylon Insulated Rings

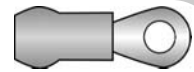

Stud	22-18AWG Red		16-14AWG Blue		12-10AWG Yellow	
	Part #	Pcs	Part #	Pcs	Part #	Pcs
6	2000NSC	100	2006NSC	100	2012NSC	100
	2000NSJ	20	2006NSJ	20	2012NSJ	15
8	2001NSC	100	2007NSC	100	2013NSC	100
	2001NSJ	20	2007NSJ	19	2013NSJ	15
10	2002NSC	100	2008NSC	100	2014NSC	100
	2002NSJ	20	2008NSF	50	2014NSF	50
1/4	--	--	2008NSJ	20	2014NSJ	15
	2003NSC	100	2009NSC	100	2015NSC	100
5/16	2003NSJ	15	2009NSF	50	2015NSF	50
	--	--	2009NSJ	15	2015NSJ	12
3/8	2004NSC	100	2010NSC	100	2016NSC	100
	2004NSJ	15	2010NSF	50	2016NSF	50
1/2	--	--	2010NSJ	15	2016NSJ	12
	2005NSC	100	2011NSC	100	2017NSC	100
1/2	2005NSJ	15	2011NSJ	15	2017NSF	50
	--	--	--	--	2017NSJ	12
1/2	--	--	--	--	2018NSC	100
	--	--	--	--	--	--

## Heat Shrink Insulated Waterproof Rings



Stud	22-18AWG Red		16-14AWG Blue		12-10AWG Yellow	
	Part #	Pcs	Part #	Pcs	Part #	Pcs
6	2300H	3	2306H	3	2312H	3
	--	--	2306J	5	2312J	4
8	2301H	3	2307H	3	2313H	3
	2301J	5	2307J	5	2313J	4
10	2302H	3	2308H	3	2314H	3
	2302J	5	2308J	5	2314J	4
1/4	2303H	3	2309H	3	2315C	100
	2303J	5	2309J	5	2315H	3
5/16	--	--	--	--	2315J	4
	--	--	2310H	3	2316H	3
3/8	2305H	3	2310J	5	2316J	4
	2305J	5	2311H	3	2317C	100
1/2	--	--	2311J	5	2317H	3
	--	--	--	--	2317J	4
1/2	--	--	--	--	2318C	100
	--	--	--	--	2318H	3
1/2	--	--	--	--	2318J	4
	--	--	--	--	--	--

## Solder Seal Rings



Stud	22-18AWG Red		16-14AWG Blue		12-10AWG Yellow	
	Part #	Pcs	Part #	Pcs	Part #	Pcs
6	2300SF	20	2306SJ	3	--	--
	2300SJ	3	--	--	--	--
8	2301SF	20	2307SF	15	--	--
	2301SJ	3	2307SJ	3	--	--
10	2302SF	20	2308SF	15	2314SF	15
	2302SJ	3	2308SJ	3	2314SJ	3
1/4	2303SF	20	2309SF	15	2315SF	15
	2303SJ	3	2309SJ	3	2315SJ	3
5/16	2304SF	15	2310SF	15	2316SF	15
	2304SJ	2	2310SJ	3	2316SJ	3
3/8	2305SF	15	2311SF	15	2317SF	15
	2305SJ	3	2311SJ	3	2317SJ	3
1/2	--	--	--	--	2318SF	15
	--	--	--	--	2318SJ	3

## Vinyl Insulated Rings

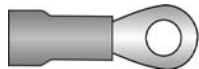

Stud	22-18AWG Red		16-14AWG Blue		12-10AWG Yellow	
	Part #	Pcs	Part #	Pcs	Part #	Pcs
6	2000C	100	2006B	5	2012C	100
	2000H	19	2006C	100	2012H	14
8	--	--	2006H	19	--	--
	--	--	2006M	1000	--	--
10	2001C	100	2007C	100	2013C	100
	2001H	19	2007H	19	2013H	14
1/4	--	--	2007M	1000	--	--
	2002B	5	2008B	5	2014B	4
5/16	2002C	100	2008C	100	2014C	100
	2002H	19	2008F	50	2014D	500
3/8	--	--	2008H	19	2014H	14
	--	--	2008M	1000	--	--
1/2	2003C	100	2009B	4	2015B	3
	2003H	14	2009C	100	2015C	100
1/2	--	--	2009D	500	2015D	500
	--	--	2009H	14	2015F	50
1/2	2004C	100	--	--	2015H	12
	2004H	14	2010B	4	2016B	3
1/2	--	--	2010C	100	2016C	100
	--	--	2010D	500	2016D	500
1/2	--	--	2010H	14	2016F	50
	--	--	--	--	2016H	12
1/2	2005C	100	2011C	100	2017B	3
	2005H	14	2011D	500	2017C	100
1/2	--	--	2011H	14	2017D	500
	--	--	--	--	2017F	50
1/2	--	--	--	--	2017H	12
	--	--	--	--	2018B	2
1/2	--	--	--	--	2018C	100
	--	--	--	--	2018F	50
1/2	--	--	--	--	2018H	7
	--	--	--	--	--	--

## Butt Connectors

	Red 22-18AWG		Blue 16-14AWG		Yellow 12-10AWG	
	Part #	Pcs	Part #	Pcs	Part #	Pcs
	non-insulated	1060C	100	1061C	100	1062C
	1060H	25	1061H	25	1062H	25
	2060B	5	2061B	5	2062B	3
vinyl	2060C	100	2061C	100	2062C	100
	2060H	20	2061H	20	2062D	500
	2060M	1000	2061M	1000	2062H	14

	Red 22-18AWG		Blue 16-14AWG		Yellow 12-10AWG	
	Part #	Pcs	Part #	Pcs	Part #	Pcs
	nylon	2065C	100	2066B	4	2067C
	2065H	14	2066C	100	2067F	50
	--	--	2066H	14	2067H	8
	--	--	2066M	1000	--	--
heat shrink	2070C	100	2071C	100	2072C	100
solder seal	2370SF	15	2371SF	15	2372SF	15
	2370SJ	3	2371SJ	3	2372SJ	3

## Non-Insulated Heavy Duty Rings & Butt Connectors

AWG	10 Stud		1/4" Stud		5/16" Stud		3/8" Stud		1/2" Stud		H.D. Butt Connectors		
	Part #	Pcs	Part #	Pcs	Part #	Pcs	Part #	Pcs	Part #	Pcs	AWG	Part #	Pcs
8	1019C	100	1020C	100	1021C	100	1022C	100	1023C	100	8	1063C	100
	1019H	7	1020H	7	1021H	7	1022H	7	1023H	4		1063H	4
6	1024C	100	1025C	100	1026C	100	1027C	100	1028C	100	6	1064C	100
	1024H	4	1025H	4	1026H	4	1027H	4	1028H	2		1064H	2
4	--	--	1029C	100	1030C	100	1031C	100	1032C	100	4	1065C	100
	--	--	1029H	3	1030H	3	1031H	3	1032H	3		1065H	2
2	--	--	1033C	100	1034C	100	1035C	100	1036C	100	2	1066C	100
	--	--	--	--	--	--	1035H	2	--	--		1066H	2
1/0	--	--	1071C	100	1072C	100	1073C	100	1074C	100	1/0	1067C	100
	--	--	--	--	--	--	1073F	2	1074F	2		--	--
2/0	--	--	1075C	100	1076C	100	1077C	100	1078C	100	2/0	1068C	100
	--	--	--	--	--	--	1077F	2	1078F	2		1068F	2
3/0	--	--	--	--	--	--	1079C	100	1080C	100	3/0	--	--
	--	--	--	--	--	--	--	--	1080F	2		--	--

## Seamless Tubular Copper Lugs

AWG	10 Stud		1/4" Stud		5/16" Stud		3/8" Stud		1/2" Stud		Copper Butt Connectors		
	Part #	Pcs	Part #	Pcs	Part #	Pcs	Part #	Pcs	Part #	Pcs	AWG	Part #	Pcs
8	1300C	100	--	--	--	--	--	--	--	--	8	1349C	100
	1300F	5	--	--	--	--	--	--	--	--		1349F	5
6	--	--	1303C	100	--	--	1305C	100	1306C	100	6	1350C	100
	--	--	1303F	5	--	--	1305F	5	1306F	5		1350F	5
4	--	--	1307C	100	1308C	100	1309C	100	--	--	4	1351C	100
	--	--	1307F	5	1308F	5	1309F	5	--	--		1351F	5
2	--	--	1312C	100	1313C	100	1314C	100	--	--	2	1352C	100
	--	--	1312F	5	1313F	5	1314F	5	--	--		1352F	5
1	--	--	1318C	100	--	--	1319C	100	1320C	100	1	1353C	100
	--	--	1318F	5	--	--	1319F	5	1320F	5		1353F	5
1/0	--	--	--	--	--	--	1324C	100	1325C	100	1/0	1354C	100
	--	--	--	--	--	--	1324F	5	1325F	5		1354F	5
2/0	--	--	--	--	--	--	1330C	100	1331C	100	2/0	1355C	100
	--	--	--	--	--	--	1330F	5	1331F	5		1355F	5
3/0	--	--	--	--	--	--	1336C	100	1337C	100	3/0	1356C	100
	--	--	--	--	--	--	1336F	5	1337F	5		1356F	5
4/0	--	--	--	--	--	--	1342C	100	1343C	100	4/0	1357C	100
	--	--	--	--	--	--	1342F	5	1343F	5		1357F	5

## Heavy Duty Vinyl Rings

AWG	10 Stud		1/4" Stud		5/16" Stud		3/8" Stud		1/2" Stud		H. D. Vinyl Butt Connectors		
	Part #	Pcs	Part #	Pcs	Part #	Pcs	Part #	Pcs	Part #	Pcs	AWG	Part #	Pcs
8	2019C	100	2020C	100	2021C	100	2022C	100	2023C	100	8	2063C	100
	2019H	4	2020H	4	2021H	4	2022H	4	2023H	2		2063H	2
6	2024C	100	2025C	100	2026C	100	2027C	100	2028C	100	6	2064C	100
	2024H	3	2025H	3	2026H	3	2027H	3	2028H	2		2064H	2
4	--	--	2029C	100	2030C	100	2031C	100	2032C	100	4	2068C	100
	--	--	2029J	2	2030J	2	2031J	2	2032J	2		2068F	2
2	--	--	2033C	100	2034C	100	2035C	100	2036C	100	2	2069C	100
	--	--	2033J	2	2034J	2	2035J	2	2036J	2		2069F	2



Ordering is easy!  
Electronic Data Interchange  
Phone, Fax, Email

### Non-Insulated Spades



22-18AWG			16-14AWG		12-10AWG	
Stud	Part #	Pcs	Part #	Pcs	Part #	Pcs
6	1050C	100	1053C	100	1056C	100
	1050H	25	1053H	25	1056H	25
8	1051C	100	1054C	100	1057C	100
	1051H	25	1054H	25	1057H	25
10	1052C	100	1055C	100	1058C	100
	1052H	25	1055H	25	1058H	25

### Vinyl Insulated Spades



22-18AWG Red			16-14AWG Blue		12-10AWG Yellow	
Stud	Part #	Pcs	Part #	Pcs	Part #	Pcs
6	2050C	100	2053B	5	2056C	100
	2050H	19	2053C	100	2056H	14
	--	--	2053H	19	--	--
8	2051C	100	2054C	100	2057C	100
	2051H	19	2054H	19	2057H	14
	--	--	2054M	1000	--	--
10	2052C	100	2055B	5	2058B	4
	2052H	19	2055C	100	2058C	100
	--	--	2055H	19	2058H	14
	--	--	2055M	1000	--	--

### Nylon Insulated Spades

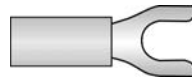

22-18AWG Red			16-14AWG Blue		12-10AWG Yellow	
Stud	Part #	Pcs	Part #	Pcs	Part #	Pcs
6	2050NSC	100	2053NSC	100	2056NSC	100
	2050NSJ	20	2053NSJ	20	2056NSJ	15
8	2051NSC	100	2054NSC	100	2057NSC	100
	2051NSJ	20	2054NSJ	20	2057NSJ	15
10	2052NSC	100	2055NSC	100	2058NSC	100
	2052NSJ	20	2055NSF	50	2058NSF	50
	---	---	2055NSJ	20	2058NSJ	15

### Solder Seal Heat Shrink Insulated Spades



22-18AWG Red			16-14AWG Blue		12-10AWG Yellow	
Stud	Part #	Pcs	Part #	Pcs	Part #	Pcs
10	2352SF	15	2355SF	15	2358SF	15
	2352SJ	3	2355SJ	3	2358SJ	2

### Non-Insulated Male Disconnects



22-18AWG			16-14AWG		12-10AWG	
Tab	Part #	Pcs	Part #	Pcs	Part #	Pcs
.250	1103C	100	1106C	100	1108C	100
	1103H	25	1106H	25	1108H	25

### Non-Insulated Female Disconnects

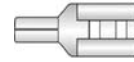

22-18AWG			16-14AWG		12-10AWG	
Tab	Part #	Pcs	Part #	Pcs	Part #	Pcs
.110	1101C	100	--	--	--	--
	1101H	25	--	--	--	--
.187	--	--	1104C	100	--	--
	--	--	1104H	25	--	--
.250	1102C	100	1105C	100	1107C	100
	1102H	25	1105H	25	1107H	25

### Vinyl Insulated Male Disconnects



22-18AWG Red			16-14AWG Blue		12-10AWG Yellow	
Tab	Part #	Pcs	Part #	Pcs	Part #	Pcs
.187	2101AH	19	2104AC	100	--	--
	--	--	2104AH	19	--	--
.250	2103C	100	2106B	5	2108B	3
	2103H	19	2106C	100	2108C	100
	--	--	2106H	19	2108D	500
	--	--	2106M	1000	2108F	50
	--	--	--	--	2108H	15
	--	--	--	--	--	--

### Vinyl Insulated Female Disconnects

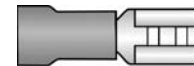

22-18AWG Red			16-14AWG Blue		12-10AWG Yellow	
Tab	Part #	Pcs	Part #	Pcs	Part #	Pcs
.110	2100C	100	--	--	--	--
	2100H	19	--	--	--	--
.187	2101C	100	2104B	5	--	--
	2101H	19	2104C	100	--	--
	--	--	2104H	19	--	--
.250	2102C	100	2105B	5	2107B	3
	2102H	19	2105C	100	2107C	100
	2102M	1000	2105H	20	2107D	500
	--	--	2105M	1000	2107F	50
	--	--	--	--	2107H	15
	--	--	--	--	2113C	100
.375	--	--	--	--	2113H	7
	--	--	--	--	--	--

### Nylon Insulated Male Disconnects

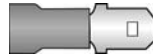

22-18AWG Red      16-14AWG Blue      12-10AWG Yellow

Tab	Part #	Pcs	Part #	Pcs	Part #	Pcs
.250	2103NSC	100	2106NSC	100	2108NSC	100
	2103NSJ	20	2106NSF	50	2108NSJ	15
	--	--	2106NSJ	20	--	--
	--	--	--	--	--	--

### Nylon Insulated Female Disconnects



22-18AWG Red      16-14AWG Blue      12-10AWG Yellow

Tab	Part #	Pcs	Part #	Pcs	Part #	Pcs
.187	2101NSJ	20	2104NSC	100	--	--
	--	--	2104NSJ	20	--	--
.250	2102NSC	100	2105NSC	100	2107NSC	100
	2102NSJ	20	2105NSF	50	2107NSJ	15
	--	--	2105NSJ	20	--	--

### Fully Insulated Nylon Male Disconnects

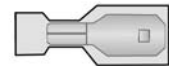

Style A    Style B



22-18AWG Red      16-14AWG Blue      12-10AWG Yellow

Tab	Part #	Pcs	Style	Part #	Pcs	Style	Part #	Pcs	Style
.250	2115C	100	A	2117B	3	A	2119C	100	B
	2115H	10	A	2117C	100	A	2119H	7	B
	--	--	--	2117D	500	A	--	--	--
	--	--	--	2117F	50	A	--	--	--
	--	--	--	2117H	10	A	--	--	--
	--	--	--	--	--	--	--	--	--
	--	--	--	--	--	--	--	--	--

### Fully Insulated Nylon Female Disconnects



Style A    Style B



22-18AWG Red      16-14AWG Blue      12-10AWG Yellow

Tab	Part #	Pcs	Style	Part #	Pcs	Style	Part #	Pcs	Style
.250	2114C	100	A	2116B	3	A	2118C	100	B
	2114H	10	A	2116C	100	A	2118H	7	B
	--	--	--	2116D	500	A	--	--	--
	--	--	--	2116F	50	A	--	--	--
	--	--	--	2116H	10	A	--	--	--
	--	--	--	--	--	--	--	--	--
	--	--	--	--	--	--	--	--	--

### Solder Seal Heat Shrink Male Disconnects



22-18AWG Red      16-14AWG Blue      12-10AWG Yellow

Tab	Part #	Pcs	Part #	Pcs	Part #	Pcs
.250	2363SF	15	2366SF	15	2368SF	15
	2363SJ	3	2366SJ	3	2368SJ	3

### Solder Seal Heat Shrink Female Disconnects



22-18AWG Red      16-14AWG Blue      12-10AWG Yellow

Tab	Part #	Pcs	Part #	Pcs	Part #	Pcs
.250	2362SF	15	2365SF	15	2367SF	15
	2362SJ	3	2365SJ	3	2367SJ	3

### High Temperature Connectors

900°F rated Nickel Plated Steel

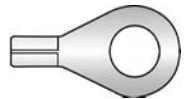

	22-18AWG		16-14AWG		12-10AWG	
Stud	Part #	Pcs	Part #	Pcs	Part #	Pcs
6	91000C	100	91006C	100	91012C	100
	91000H	30	91006H	30	--	--
8	91001C	100	91007C	100	91013C	100
	91002C	100	91008C	100	91014C	100
10	91002H	30	91008H	30	91014H	20
	91003C	100	91009C	100	91015C	100
1/4	--	--	91009H	20	91015H	14
	91005C	100	91011C	100	91017C	100

	22-18AWG		16-14AWG		12-10AWG	
Part #	Pcs	Part #	Pcs	Part #	Pcs	
91060C	100	91061C	100	91062C	100	

	22-18AWG		16-14AWG		12-10AWG	
Part #	Pcs	Part #	Pcs	Part #	Pcs	
91052C	100	91055C	100	91058C	100	

	22-18AWG		16-14AWG		12-10AWG	
Part #	Pcs	Part #	Pcs	Part #	Pcs	
91104H	20	--	--	--	--	

	22-18AWG		16-14AWG		12-10AWG	
Part #	Pcs	Part #	Pcs	Part #	Pcs	
91105C	100	91107C	100	91107H	20	
91105H	20	--	--	--	--	

	22-18AWG		16-14AWG		12-10AWG	
Part #	Pcs	Part #	Pcs	Part #	Pcs	
91116C	100	91117C	100	--	--	
91116H	20	--	--	--	--	

### Small Gauge Terminals

Nylon Rings



26-24AWG

Stud	Part #	Pcs
2	2083H	19
8	2085H	19

Nylon Spades



Part #	Pcs
2090H	19

Butts



2091C	100
2091H	11

Disconnects



Tab	Part #	Pcs
.110	2093H	19



**Ordering is easy!**  
Electronic Data Interchange  
Phone, Fax, Email

### Specialty Non-Insulated Flags

Disconnects	16-14AWG			12-10AWG	
	Tab	Part #	Pcs	Part #	Pcs
	.187	1115C	100	--	--
		1115H	35	--	--
	.250	1116C	100	1117C	100
		1116H	30	1117H	15

Rings	16-14AWG			12-10AWG	
	Stud	Part #	Pcs	Part #	Pcs
	10	1040B	5	1041B	4

Spades	16-14AWG			12-10AWG	
	Stud	Part #	Pcs	Part #	Pcs
	10	1043B	5	1044B	4

### Specialty Disconnects

Split Male Housing	Tab	Part #	Pcs	Split Male Disconnect	Part #	Pcs
		.250	1203C		100	
1203H			15	1202H	15	

Split Female Housing	Tab	Part #	Pcs	Split Female Disconnect	Part #	Pcs
		.250	1201C		100	
1201H			15	1200H	15	

### Specialty Bullet Receptacles

Double Plug Nylon FM Bullet Receptacle	Dia.	16-14AWG		3M Inline Receptacle	16-14AWG	
		Part #	Pcs		Part #	Pcs
	.157	1213B	2		1221B	1 set
		1213C	100		1221C	100
		1213H	9		1221F	50
		--	--		1221H	3

### Specialty Adapters

Glass Fuse Power Tap

Tab	Part #	Pcs	
	.250	1212B	4
		1212C	100
		1212H	19

ATC/ATO Fuse Power Tap

Tab	Part #	Pcs	
	.250	1208B	3
		1208C	100
		1208H	10

16-14 AWG Piggybacks

Tab	Part #	Pcs	
	.250	2109B	2
		2109C	100
		2109D	500
		2109H	9

Mini Blade Fuse Power Tap

Tab	Part #	Pcs	
	.187	1210C	100
		1210H	10

Tab to #10 Ring Adapter

Tab	Part #	Pcs	
	.250	1209C	100
		1209H	21

Nylon Double Male

Tab	Part #	Pcs	
	.250	1214B	2
		1214C	100
		1214H	7

### Tap Splice Connectors

Red w/stop 22-16AWG		Blue w/stop 18-14AWG		White no stop 18-14AWG		Yellow w/stop 12-10AWG		Brown w/stop 18-10AWG	
Part #	Pcs	Part #	Pcs	Part #	Pcs	Part #	Pcs	Part #	Pcs
1220-2C	100	1220B	2	1220-1C	100	1219B	1	1218C	100
1220-2F	50	1220C	100	1220-1D	500	1219C	100	1218F	50
1220-2H	6	1220D	500	1220-1H	7	1219F	50	1218H	3
--	--	1220F	50	--	--	1219H	4	--	--

### T-Tap Splice Connectors

use with matching fully insulated male disconnect see page 4.

Red 22-18AWG		Blue 16-14AWG		Yellow 12-10AWG	
Part #	Pcs	Part #	Pcs	Part #	Pcs
	1229C	100		1230B	1 set
	1229F	50		1230C	100
	1229H	8		1230F	50
	--	--		1230H	8
use with 2115		use with 2117		use with 2119	

### Non-Insulated 16-14AWG Piggyback

Tab	Part #	Pcs	
	.250	1109C	100
		1109H	9

### Female to Double Male Flat Adapter

Tab	Part #	Pcs	
	.250	1211C	100
		1211H	16

### Male/Female/Male Piggyback

Tab	Part #	Pcs	
	.250	1207C	100
		1207H	12

### Female to Double Male Chair Adapter

Tab	Part #	Pcs	
	.250	1206B	2
		1206C	100
		1206H	7

wiring accessories master catalog rev704



## Twist Connects

Gray  
22-16AWG

Part #	Pcs
71C	100
71H	10
--	--
--	--



Blue  
22-14AWG

Part #	Pcs
72C	100
72F	50
72H	10
--	--



Orange  
22-14AWG

Part #	Pcs
73C	100
73F	50
73H	9
--	--



Yellow  
18-12AWG

Part #	Pcs
74B	4
74C	100
74F	50
74H	9



Red  
18-10AWG

Part #	Pcs
76C	100
76F	50
76H	5
--	--



## Soft Vinyl Twist Connects

Yellow  
18-12AWG

Part #	Pcs
1222C	100
1222F	75
1222H	6



Red  
16-10AWG

Part #	Pcs
1223C	100
1223F	50
1223H	6

Blue  
12-6AWG

Part #	Pcs
1224C	100
1224F	25
1224H	3

Grey  
14-8AWG

Part #	Pcs
1225C	100
1225F	25
1225H	5

## Combination Packs

### Split Connectors & Housing

Split Female  
Housing  
1201

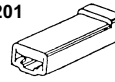

Split Female  
Disconnect  
1200

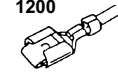

Split Male  
Housing  
1203

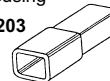

Split Male  
Disconnect  
1202



### Bullet & Receptacle

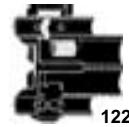

### 16-14AWG

Tab	Part #	Pcs
.250	1204B	1 Set
	1204H	7 Sets

Tab	Part #	Pcs
.250	1205B	1 Set
	1205H	7 Sets

### 16-14AWG

Dia	Part #	Pcs
.157	1221B	2 Sets

## Vinyl Bullet Connectors

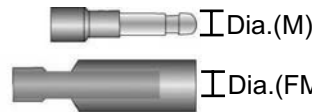

### 22-18AWG

Dia.	Part #	Pcs
.157(M)	2125C	100
	2125H	19
	--	--
.157(FM)	2124C	100
	2124H	7
.176(M)	--	--
	--	--
	--	--
.176(FM)	--	--
	--	--

### 16-14AWG

Part #	Pcs	Part #	Pcs
2111B	3	2111F	50
2111C	100	2111H	20
2111F	50	--	--
2112B	2	--	--
2112C	100	2112F	50
2112D	500	2112H	7
2110B	5	--	--
2110C	100	--	--
2110H	19	--	--
--	--	2123H	7
--	--	2123C	100

## Combination Packs

### Ring Assortments

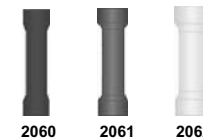

### 22-18AWG

Stud	Part #	Pcs
6, 8, 10, 1/4	2150H	19

### 16-14AWG

Stud	Part #	Pcs
6, 8, 10, 1/4	2151H	19

### 22-10AWG

Part #	Pcs
2156B	4
2156H	17

## Nylon Bullet Connectors

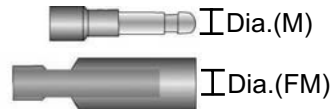

### 22-18AWG

Dia.	Part #	Pcs
.157(M)	2125NSC	100
	2125NSJ	20
.157(FM)	2124NSC	100
	2124NSJ	20
.176(M)	--	--
.176(FM)	--	--

### 16-14AWG

Part #	Pcs
2111NSC	100
2111NSJ	20
2112NSC	100
2112NSJ	7
2110NSC	100
2123NSC	100

### Assortments by Gauge

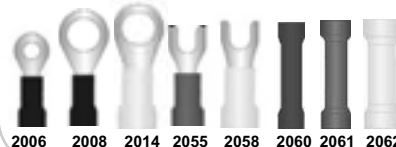

### 22-18AWG

Stud	Part #	Pcs
6, 10	2152H	19

### 16-14AWG

Stud	Part #	Pcs
6, 10	2153H	19

### 12-10AWG

Stud	Part #	Pcs
6, 10, 1/4	2154H	14

### 22-10AWG

Stud	Part #	Pcs
6, 10	2157H	16



**Ordering is easy!**  
Electronic Data Interchange  
Phone, Fax, Email

### Compressor Terminals

Large Terminal **12-8AWG**

Tab	Part #	Pcs
.250	1119C	100
	1119H	7

Small Flag **12-10AWG**

Part #	Pcs
1048F	50
1048P	25

### Mixed Disconnect Assortment

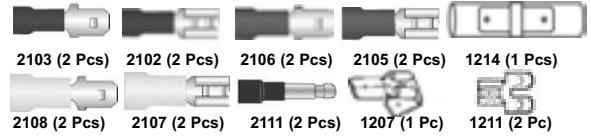

**22-18AWG | 16-14AWG | 12-10AWG**

Tab	Part #	Pcs
.250	2155H	18

### Twist Connect Assortment

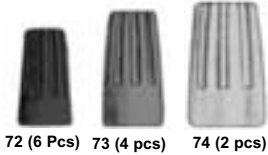

**22-12AWG**

Part #	Pcs
2158H	12

### Disconnect 22-18AWG Assortment (2 Pcs ea)

**22-18AWG**

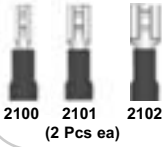

Tab	Part #	Pcs
.110, .187, .250	2155B	6

### T-Tap w/Fully Insulated Disconnect

22-18AWG		16-14AWG		12-10AWG	
Part #	Sets	Part #	Sets	Part #	Sets
2129B	2	2122H	4	2131H	2
2129H	4	--	--	--	--

### Compressor Lead Sets

includes 3 heat shrink insulated water-proof butt connectors

10 Gauge		
Tab	Part #	Sets
.250	2520F	3

10 Gauge		
Stud	Part #	Sets
.250	2521F	3

### Fully Insulated Disconnect Combinations

22-18AWG		16-14AWG	
Part #	Sets	Part #	Sets
2120H	5	2121B	2
--	--	2121H	5

### Insulation Displacement Telecom Connectors

Green 19-26AWG		Red 19-26AWG		Yellow 22-26AWG	
Part #	Pcs	Part #	Pcs	Part #	Pcs
20503H	4	20506C	100	20507C	100
--	--	20506H	4	20507H	4

### Proper Crimping Technique

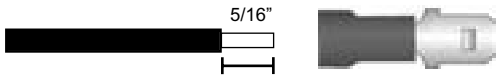

- 1) Select the proper connector for wire gauge and application
- 2) Strip insulation 5/16" (8mm) from wire end
- 3) Insert stripped wire into connector barrel and crimp (indicated by arrows)

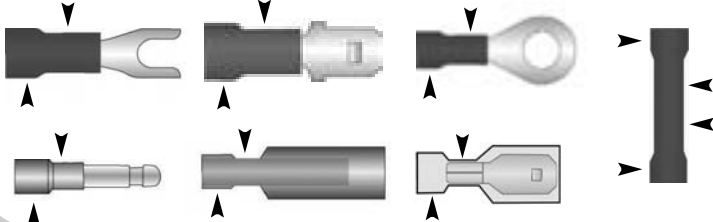









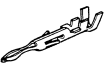

### Nylon Closed End Connectors

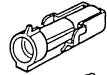
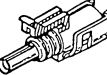
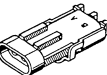
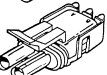
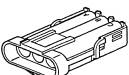
22-14AWG		12-10AWG	
Part #	Pcs	Part #	Pcs
1216C	100	1217B	3
1216H	15	1217C	100
--	--	1217H	10

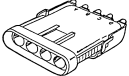
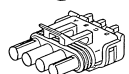
wiring accessories master catalog rev704

## Weather Pack Series OEM Terminals

	Part #	Pcs	Description	AWG	OEM Part #
	<b>2200F</b> <b>2200H</b>	30 6	Tin plated male, mates with 2203	20-18	12089040
	<b>2203F</b> <b>2203H</b>	30 6	Tin plated female.mates with 2200	20-18	12089188
	<b>2208F</b> <b>2208H</b>	30 6	Tin plated male, mates with 2211	16-14	12089305
	<b>2211F</b> <b>2211H</b>	30 6	Tin plated female, mates with 2208	16-14	12010182
	<b>2216F</b>	1	Nylon single shroud for male, mates with 2217		12010996
	<b>2217F</b>	1	Nylon single cavity for female, mates with 2216		12015791
	<b>2219F</b>	1	Nylon double shroud for male, mates with 2220		2010973
	<b>2220F</b>	1	Nylon double tower for female, mates with 2219		12015792
	<b>2222F</b>	1	Nylon triple shroud for male, mates with 2223		12010717
	<b>2223F</b>	1	Nylon triple cavity for female, mates with 2222		12015793
	<b>2225F</b>	1	Nylon four shroud for male, mates with 2226		12010974
	<b>2226F</b>	1	Nylon four cavity for female, mates with 2227		12015797
	<b>2227F</b>	1	Nylon six shroud for male, mates with 2228		12010975
	<b>2228F</b>	1	Nylon six cavity for female, mates with 2227		12015799
	<b>2205F</b> <b>2205H</b>	30 6	Cable Seal Gray	16-12	--
	<b>2206F</b> <b>2206H</b>	30 6	Cable Seal Green	20-14	12015323
	<b>2214F</b> <b>2214H</b>	30 6	Cavity Plug- Silicone Rubber		12010300



**Ordering is easy!**  
**Electronic Data Interchange**  
**Phone, Fax, Email**

Part #	Pcs	Description	AWG	OEM Part #
<b>GM Electronic Control</b>				
<b>20100J</b>	6	ECM Terminal	20 -18	12030453
<b>20101J</b>	6	ECM Terminal	20 -18	12020757
<b>GM Micropack</b>				
<b>20102J</b>	6	Female Terminal	16 -14	12020768/12020758
<b>20103J</b>	6	Male Terminal	22	12040902
<b>GM Metri Pack 150 Series</b>				
<b>20104J</b>	6	Tin Plated Female	20 -18	12047680
<b>20105J</b>	6	Tin Plated Male	20 -18	12047581
<b>20106J</b>	6	Tin Plated Female	20 -16	12047767
<b>GM Metri Pack 280 Series</b>				
<b>20107J</b>	6	Tin Plated Male	16 -14	12020116
<b>20108J</b>	6	Tin Plated Female	16 -14	12066214/12015857
<b>20109J</b>	6	Tin Plated Male	20 -18	12034047
<b>20110J</b>	6	Tin Plated Female	20 -18	12034046/12015823
<b>GM Metri Pack 480 Series</b>				
<b>20111J</b>	6	Tin Plated Male	16 -14	12020120
<b>20112J</b>	6	Tin Plated Female	16 -14	12015861
<b>Ford Wedgelock Pin-Type</b>				
<b>20113J</b>	6	Male Terminal	20 -18	01AB-14461-7AA
<b>20114J</b>	6	Female Terminal	20 -18	01AB-14488-CA
<b>Ford Box Female &amp; Tab Terminals</b>				
<b>20115J</b>	6	Female Terminal	20 -18	D3AB-14474DA
<b>20116J</b>	6	Male Terminal	20 -18	D20BB-14421BB
<b>Ford and Chrysler Snap-on Female Terminals</b>				
<b>20117J</b>	6	Female Terminal	20-18	D5AB-14474FA D5AZ-14474G
<b>20118J</b>	6	1/4" Female Terminal	20-18	65AB-14474-B/12096466
<b>20119J</b>	6	Male Tab .250	20-18	3843386
<b>20120J</b>	6	Female Tab .250	20-18	3843601

**Open Barrel Crimping Instructions using the 5000F tool**

- Align contact centrally on anvil as shown in illustration.
- Close tool carefully until contact is held in place without distorting ears. Insert stripped wire allowing it to protrude about 1/32" past conductor ears.
- Squeeze handles to complete crimp.



**5000F Crimping Tool**

Weather pack tool designed for crimping open barrel 18, 16 & 14 gauge terminals.



**5012F Weather Pack Extractor**

Designed for extracting weather-pack terminals from their connector housing for servicing and replacement.



**5013F Narrow blade .050"**

**5014F Wide blade .090"**

**Weather Pack Terminal Extractor Picks**

Used to release most GM Ford and Chrysler OEM terminals from their insulating housings.



**Weather Pack Complete Assemblies**



Part #	Pcs	Description
<b>3850.</b>	1	Single shroud male
<b>2865F</b>	2	M/FM combo pack
<b>2851F</b>	1	Double shroud male
<b>2866F</b>	2	M/FM combo pack
<b>3855.</b>	1	Triple shroud male
<b>2867F</b>	2	M/FM combo pack
<b>2853F</b>	1	Quad shroud male
<b>2868F</b>	2	M/FM combo pack

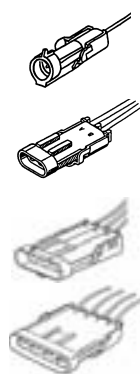

Part #	Pcs	Description
<b>2854F</b>	1	Single cavity female
<b>3853.</b>	1	Double cavity female
<b>2856F</b>	1	Triple cavity female
<b>2857F</b>	1	Quad cavity female

wiring accessories master catalog rev704

**6982F 83Pc Terminal Kit** in handy slide blister slide-box



Part #	Description	Pcs
2102	22-18AWG FM Disconnect	5
2103	22-18AWG M Disconnect	4
2000	22-18AWG #6 Ring	5
2002	22-18AWG #10 Ring	5
2051	22-18AWG #8 Spade	5
2052	22-18AWG #10 Spade	4
2060	22-18AWG Butt Connector	4
2006	16-14AWG #6 Vinyl Spade	5
2007	16-14AWG #8 Ring	5
2008	16-14AWG #10 Ring	5
2054	16-14AWG #8 Spade	5
2055	16-14AWG #10 Spade	5
2061	16-14AWG Vinyl Butt Connector	5
2105	16-14AWG Vinyl FM Disconnect	4
2106	16-14AWG Vinyl M Disconnect	4
2014	12-10AWG #10 Vinyl Ring	4
2015	12-10AWG 1/4" Vinyl Ring	4
2062	12-10AWG Vinyl Butt Connector	5

**6991F 25pc Do-it-Yourself Kit**

Economy crimper and wire stripper tool and assorted terminals in a reusable box.



Part #	Description	Pcs
5002	Stripper / Crimper	1
2061	14-16AWG Butt Connector	4
2060	22-18AWG Butt Connector	3
2002	22-18AWG #10 Rings	3
2052	22-18AWG #10 Spades	3
2105	16-14AWG FM Disconnns	3
2106	16-14AWG M Disconnns	3
2055	16-14AWG #10 Spades	3
2008	16-14AWG #10 Rings	3

**6992F 95pc Deluxe Wiring Kit**

Includes terminal assortment and crimper / stripper in a durable case.



Part #	Description	Pcs
2102	22-18AWG FM Disconn	5
2103	22-18AWG M Disconn	5
2000	22-18AWG #6 Ring	10
2052	22-18AWG #10 Spade	10
2060	22-18AWG Butt Connector	10
2061	16-14AWG Butt Connector	10
2062	12-10AWG Butt Connector	3
2006	16-14AWG #6 Vinyl Spade	10
2055	16-14 #10 Spade	10
2013	12-10AWG #8 Ring	3
2105	16-14AWG FM Disconnect	5
2106	16-14AWG M Disconnect	5
2014	12-10AWG #10 Ring	3
2015	12-10AWG 1/4" Ring	4

**6986F 180pc Wiring Terminal Kit**

Large assortment of common electrical terminals in an attractive clear carrying case.



Part #	Description	Pcs
2108	12-10AWG M Disconn	4
2107	12-10AWG FM Disconn	4
2062	12-10AWG Butt Connect	4
2102	22-18AWG FM Disconn	12
2105	16-14AWG FM Disconn	11
2106	16-14AWG M Disconn	11
2006	16-14AWG #6 Ring	11
2007	16-14AWG #8 Ring	13
2008	16-14AWG #10 Ring	12
2009	16-14AWG 1/4" Ring	9
2061	16-14AWG Butt Connect	11
2000	22-18AWG #6 Ring	11
2001	22-18AWG #8 Ring	12
2002	22-18AWG #10 Ring	11
2050	22-18AWG #6 Vinyl Spade	10
2051	22-18AWG #8 Vinyl Spade	12
2052	22-18AWG #10 Vinyl Spade	11
2060	22-18AWG Vinyl Butt Connector	11

**6990F 2200Pc Professional Terminal Kit** Largest assortment offered in a durable metal case.



Part #	Description	Pcs	Part #	Description	Pcs
1220	18-14AWG Midline Splice	50	2105	16-14AWG FM Disconnect	100
2008	16-14AWG #10 Ring	100	2106	16-14AWG M Disconnect	100
2009	16-14AWG 1/4" Ring	100	2107	12-10AWG FM Disconnect	100
2011	16-14AWG 3/8" Ring	100	2108	12-10AWG M Disconnect	100
2014	12-10AWG #10 Ring	100	2111	16-14AWG M Bullet Plug	100
2015	12-10AWG 1/4" Ring	100	2112	16-14AWG FM Bullet Recpt	100
2017	12-10AWG 3/8" Ring	100	2116	16-14AWG FM Full Ins Disc	100
2054	16-14AWG #8 Spade	100	2117	16-14AWG M Full Ins Disc	100
2055	16-14AWG #10 Spade	100	2124	22-18AWG FMBullet Recpt	100
2060	22-18AWG Butt Connector	100	2125	22-18AWG M Bullet plug	100
2061	16-14AWG Butt Connector	100	1217	12-10AWG Closed Conn	50
2062	12-10AWG Butt Connector	100	6005	Large Metal Latching Box	1

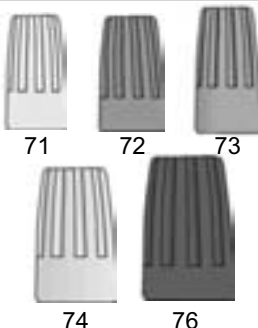

**6985F- 50pc Twist Connect Kit**  
Assortment of 50 twist connects in a reclosable clamshell.

Part#	Color	Pcs
71.	Grey	10
72.	Blue	10
73.	Orange	10
74.	Yellow	10
76.	Red	10



**4796F Bungie Cord Kit**  
6 Heavy Duty Bungies in multiple lengths. Safety cap hooks, durable reusable.

- 2 pcs 18" Yellow
- 2 pcs 24" Blue
- 1 pc 32" Red
- 1 pc 40" Green



**Ordering is easy!**  
Electronic Data Interchange  
Phone, Fax, Email



Replacement boxes may be ordered separately from any JT&T terminal kit. Order according to the part number at the end of each item description chart.

### 6966F 665 Pc HVAC Terminal Kit

Large assortment of terminals, twist on connectors, compressor leads and hi-temp terminals for HVAC/R applications.



Part #	Description	Pcs
204702-2	4" UV Black Wire Ties	100
204706-2	7.5" UV Black Wire Ties	100
72	Blue Twist Connects	25
73	Orange Twist Connects	16
74	Yellow Twist Connects	15
1116	16-14AWG Non Ins Flag	35
1119	12-8AWG Comp Term	35
1211	Double Male Flat Adapter	35
2008	16-14AWG #10 Ring	35
2054	16-14AWG #8 Spade	35
2060	22-18AWG Butt Connect	35
2061	16-14AWG Butt Connect	35
2062	12-10AWG Butt Connect	35
2104	16-14AWG FM Disconn	35
2105	16-14AWG FM Disconn	35
2107	12-10AWG FM Disconn	35
226	HD Test Leads	1 set
2072	12-10AWG WProof Butts	27
2520.	Comp Leads w/Flags	3
2521.	Comp Leads w/Rings	3
3109-10	10AWG Motor HU Wire W	1
3102-10	10AWG Motor HU Wire R	1
3100-10	10AWG Motor HU Wire B	1
6006	Multi-Well Plastic Box	1

### 6967F 1485 Pc HVAC Master Kit

Larger assortment of terminals, twist on connectors, compressor leads and hi-temp terminals for HVAC/R applications.



Part #	Description	Pcs
204702-2	4" UV Black Wire Ties	100
204706-2	7.5" UV Black Wire Ties	100
73	22-14AWG Orange Wire	40
1116	16-14AWG Non Ins Flag	100
1119	12-8AWG Comp Term	100
1211	Double Male Flat Adapter	100
2008	16-14AWG #10 Ring	100
2054	16-14AWG #8 Spade	100
2060	22-18AWG Butt Connect	100
2061	16-14AWG Butt Connect	100
2062	12-10AWG Butt Connect	100
2105	16-14AWG FM Disconn	200
2107	12-10AWG FM Disconn	100
2109	16-14AWG Piggyback	100
226	HD Test Leads	1 set
2072	12-10AWG WProof Butts	27
4006-4	3/8" Black Heat Shrink	6
4005-4	1/4" Black Heat Shrink	9
4004-4	3/16" Black Heat Shrink	9
2520	Compressor Leads-Flags	3
2521	Compressor Leads-Rings	3
3109-10	10AWG Motor HU Wire W	2
3102-10	10AWG Motor HU Wire R	2
3100-10	10AWG Motor HU Wire B	2
80001	Multi-Well Plastic Box	1



**6000**  
Metal Storage Case  
21 Compartment  
13.94" x 9.25" X 2"

**6003**  
Metal Storage Case  
24 Compartment  
13.31" x 9.25" X 2"

**6005**  
Large Metal Storage Case  
24 Compartment  
18.25" x 12" x 3"

### 6989F 300pc Deluxe Terminal Kit

Includes the most popular splices, terminals and wire ties



Part #	Description	Pcs
1220	18-14AWG Midline Taps	8
2008	16-14AWG #10 Vinyl Ring	12
2009	16-14AWG 1/4" Vinyl Ring	12
2011	16-14AWG 3/8" Vinyl Ring	12
2014	12-10AWG #10 Vinyl Ring	12
2015	12-10AWG 1/4" Vinyl Ring	12
2017	12-10AWG 3/8" Vinyl Ring	12
2054	16-14AWG #8 Vinyl Spade	12
2055	16-14AWG #10 Vinyl Spade	12
2060	22-18AWG Vinyl Butt	12
2061	16-14AWG Vinyl Butt	12

Part #	Description	Pcs
2062	12-10AWG Vinyl Butt	12
2105	16-14AWG FM Disconnect	12
2106	16-14AWG M Disconnect	12
2107	12-10AWG FM Vinyl Discon	12
2111	16-14AWG M Bullet Plug	12
2112	16-14AWG FM Bullet Recep	12
2116	16-14AWG FM Fully Ins Dis	10
2117	16-14AWG M Fully Ins Dis	10
2124	22-18AWG FM Bullet Recep	10
2125	22-18AWG M Bullet Recep	10
6006	Multi-Well Plastic Box	1

Part #	Description	Pcs
X204701-4	4" Natural Wire Tie	20
X204703-4	5.5" Natural Wire Tie	20
X204705-4	7.5" Natural Wire Tie	20

### 4794F 1,200pc Wire Tie Kit

Large selection of lengths and colors, including stainless steel tie samples, in a reclosable case.



Part #	Description	Pcs
X204701-2	4.0" Natural	100
X204701-2-6	4.0" Blue	100
X204701-2-13	4.0" Neon Yellow	100
X204701-2-7	4.0" Purple	100
X204701-2-11	4.0" Neon Green	100
X204701-2-14	4.0" Neon Orange	100
X204702-2	4.0" U.V. Black	200
X204703-2	5.5" Natural	100
X204704-2	5.5" U.V. Black	200
X204706-2	7.5" U.V. Black	100
X304705-1	7.5" Stainless Steel	2

### 4790F 650pc Wire Tie Kit

Large selection of lengths and colors in a reclosable case.



Part #	Description	Pcs
X204701-2	4.0" Natural	200
X204702-2	4.0" U.V. Black	100
X204701-4-6	4.0" Blue	20
X204701-4-14	4.0" Neon Orange	20
X204701-4-4	4.0" Yellow	20
X204701-4-11	4.0" Neon Green	20
X204701-4-12	4.0" Neon Pink	20
X204705-2	7.5" Natural	100
X204707-2	11.5" Natural	100
X204705-4-2	7.5" Red	10
X204705-4-6	7.5" Blue	10
X204705-4-7	7.5" Purple	10
X204705-4-4	7.5" Yellow	10
X204706-4	7.5" U.V. Black	10

### 4791F 500pc Wire Tie Kit

Large selection of lengths and colors in a reclosable case.



Part #	Description	Pcs
X204701-4	4.0" Natural	150
X204702-2	4.0" U.V. Black	100
X204705-2	7.5" Natural	100
X204706-4	7.5" U.V. Black	50
X204707-3	11.5" Natural	50
X204708-3	11.5" U.V. Black	50

### 4792F 650pc Wire Tie Kit

Selection of natural ties in a reclosable case.



Part #	Description	Pcs
X204701-2	4.0" Natural	300
X204705-2	7.5" Natural	300
X204707-3	11.5" Natural	50

### OEM Style Fuse Links Kits w/Connectors



Part#	Gauge	Stud	Length	Description
207H	16 AWG	5/16"	10.5"	Ford Starter Solenoid Orange
208H	14 AWG	5/16"	10.5"	Ford Starter Solenoid Green
209H	16 AWG	1/4"	9.25"	GM Starter Solenoid Black
210H	14 AWG	3/8"	9.25"	GM Starter Solenoid Black
211H	18 AWG	--	8.00"	Chrysler & Univ Ignition Battery
212H	16 AWG	--	8.00"	Chrysler Feed w/Rear Win Defog
213H	14 AWG	--	7.00"	Grey wire w/ connectors 2 Sets
214H	12 AWG	--	7.00"	Grey wire w/ connectors 2 Sets



**Ordering is easy!**  
Electronic Data Interchange  
Phone, Fax, Email

### Primary Wire

Multi-conductor stranded copper thermoplastic insulated primary wire is standard for original equipment and replacement on vehicular equipment. Its smooth surface makes it ideal for pulling through loom or **JT&T Flex-Guard Convolted Tubing**. The thermoplastic insulation operates satisfactorily between extreme temperature; -30° to +165°F and -34° to +74°C. It is resistant to grease, oil and acids and is available in seven bright colors for easy identification. Meets or exceeds S.A.E. specification

Gauge	8AWG	10AWG	12AWG	14AWG	16AWG	18AWG	22AWG
Length		8ft	12ft	15ft	20ft	30ft	25ft
<b>Black</b>		<b>100F</b>	<b>120F</b>	<b>140F</b>	<b>160F</b>	<b>180F</b>	
<b>Red</b>		<b>102F</b>	<b>122F</b>	<b>142F</b>	<b>162F</b>	<b>182F</b>	
<b>Green</b>		<b>105F</b>	<b>125F</b>	<b>145F</b>	<b>165F</b>	<b>185F</b>	
<b>Blue</b>		<b>106F</b>	<b>126F</b>	<b>146F</b>	<b>166F</b>	<b>186F</b>	
<b>Yellow</b>		<b>107F</b>	<b>127F</b>	<b>147F</b>	<b>167F</b>	<b>187F</b>	
<b>Brown</b>		<b>108F</b>	<b>128F</b>	<b>148F</b>	<b>168F</b>	<b>188F</b>	
<b>White</b>		<b>109F</b>	<b>129F</b>	<b>149F</b>	<b>169F</b>	<b>189F</b>	
<b>Speaker Wire - 2 wire</b>							<b>222F</b>
Gauge	8AWG	10AWG	12AWG	14AWG	16AWG	18AWG	22AWG
Length		75ft	100ft	100ft	100ft	100ft	100ft
<b>Black</b>	<b>80C-50ft</b>	<b>100C</b>	<b>120C</b>	<b>140C</b>	<b>160C</b>	<b>180C</b>	
<b>Red</b>	<b>82C-40ft</b>	<b>102C</b>	<b>122C</b>	<b>142C</b>	<b>162C</b>	<b>182C</b>	
<b>Green</b>		<b>105C</b>	<b>125C</b>	<b>145C</b>	<b>165C</b>	<b>185C</b>	
<b>Blue</b>		<b>106C</b>	<b>126C</b>	<b>146C</b>	<b>166C</b>	<b>186C</b>	
<b>Yellow</b>		<b>107C</b>	<b>127C</b>	<b>147C</b>	<b>167C</b>	<b>187C</b>	
<b>Brown</b>		<b>108C</b>	<b>128C</b>	<b>148C</b>	<b>168C</b>	<b>188C</b>	
<b>White</b>		<b>109C</b>	<b>129C</b>	<b>149C</b>	<b>169C</b>	<b>189C</b>	
<b>Speaker Wire - 2 wire</b>							<b>222C</b>

### 8101F - 3M Temflex™ Vinyl Electrical Tape

3M electrical tape is both economical and effective as a general purpose tape for jacketing and harnessing wiring applications. 60ft rolls.



### Motor Hook-Up Wire

PVC Insulated hook-up wire. Resistant to oil, water, acids, solvents and fungus. Conductor: Stranded Tinned Copper Insulation: Extruded polyvinylchloride 1/32" wall temperature: 105°C

Gauge	10AWG	12AWG	14AWG	16AWG	18AWG
Length	8Ft	12Ft	15Ft	16Ft	18Ft
<b>Black</b>	<b>3100.</b>	<b>3120.</b>	<b>3140.</b>	<b>3160.</b>	<b>3180.</b>
<b>Red</b>	<b>3102.</b>	<b>3122.</b>	<b>3142.</b>	<b>3162.</b>	<b>3182.</b>
<b>Green</b>	<b>3105.</b>	<b>3125.</b>	<b>3145.</b>	<b>3165.</b>	<b>3185.</b>
<b>Blue</b>	<b>3106.</b>	<b>3126.</b>	<b>3146.</b>	<b>3166.</b>	<b>3186.</b>
<b>White</b>	<b>3109.</b>	<b>3129.</b>	<b>3149.</b>	<b>3169.</b>	<b>3189.</b>



## Fusible Link Wire

Fusible link wire is designed to “open” a circuit when electrical current overload occurs. This “opening” of the circuit stops the current and prevents damage to electrical instruments or to accessories, and is most often used when the placement of a fuse is not possible. Fusible link is NOT designed to replace a normally fused system. These products meet S.A.E. specification J-156. CAUTION : A fusible link IS NOT intended to be used in place of a fuse, only where a fuse cannot be used. When replacing fusible link, the wire gauge used should be 4 gauges smaller than the existing wiring circuit. Example: 14 gauge system, use 18 gauge, fusible link wire.

### Spools and Retail Packs

Retail Pack	Gauge	Pre-cut Lengths	Color	Spools	Overall Length
201H	18 AWG	4 FT.	Blue	201C	100 FT.
202H	16 AWG	3 FT.	Black	202C	100 FT.
203H	14 AWG	3 FT.	Gray	203C	100 FT.
204H	12 AWG	2 FT.	Teal	204C	75 FT.
205H	10 AWG	1 FT.	Orange	205C	75 FT.

## Typical Vehicle Amperage Draw

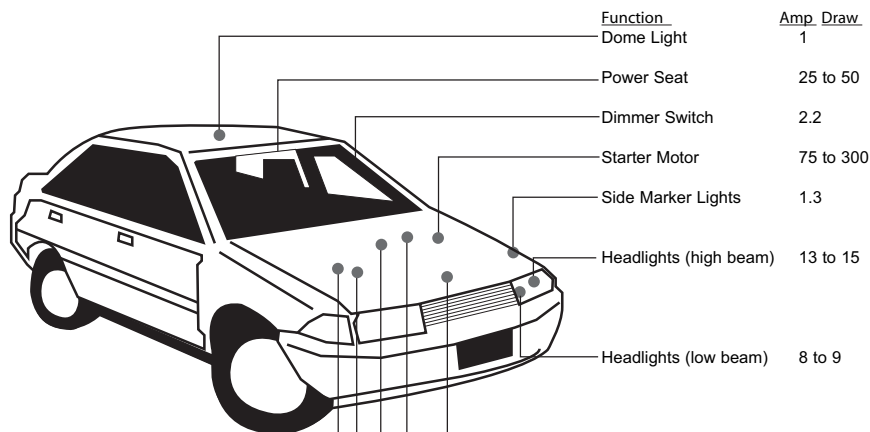

Function	Amp. Draw
Horn	18 to 20
Ignition	1.5 to 3.5
Heater/Defroster	6 to 10
Air Conditioner	13 to 20
Power Antenna	6 to 10

Function	Amp. Draw
Windshield Wipers	3 to 6
Clock	.3

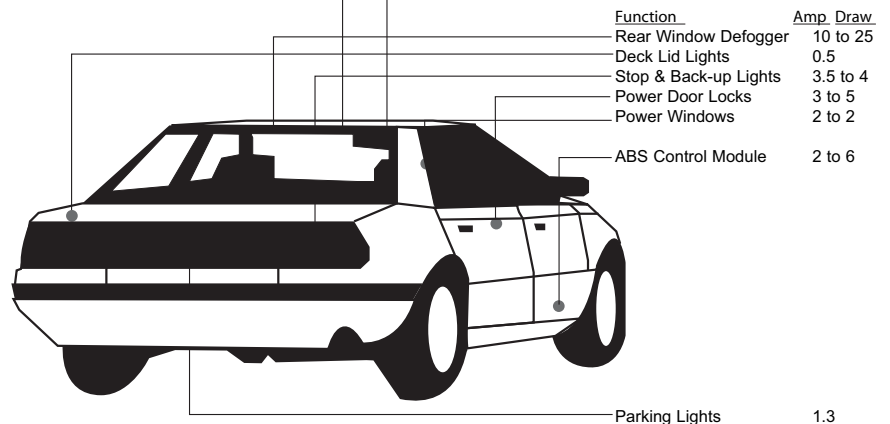

12V Wire Gauge and Length (Total Circuit Length)											
AMP	3	5	7	10	15	20	25	30	40	50	100
1	18	18	18	18	18	18	18	18	18	18	18
3	18	18	18	18	18	18	18	18	18	18	14
5	18	18	18	18	18	18	18	18	18	16	12
7	18	18	18	18	18	18	18	18	16	14	10
10	18	18	18	18	18	18	18	18	14	12	8
15	18	18	18	18	14	14	12	12	10	8	6
20	16	16	16	16	14	12	10	10	10	8	6
24	14	14	14	14	12	10	10	10	10	10	8
30	12	12	12	12	10	10	10	10	8	4	4
40	10	10	10	10	10	10	10	8	6	4	2
50	8	8	8	8	8	8	8	8	6	2	2
100	4	4	4	4	4	4	4	4	2	1	1/2
150	2	2	2	2	2	2	2	2	1	2/3	2/3
200	1/2	1/2	1/2	1/2	1/2	1/2	1/2	1/2	1/2	1/2	1/2



Ordering is easy!  
Electronic Data Interchange  
Phone, Fax, Email



### Glass Fuses

Part #	Pcs	Type	Color	Rating
2406E	2	AGC	--	5 Amp
2408E	2	AGC	--	7.5 Amp
2409E	2	AGC	--	10 Amp
2410E	2	AGC	--	15 Amp
2411E	2	AGC	--	20 Amp
2412E	2	AGC	--	25 Amp
2413E	2	AGC	--	30 Amp
2415E	2	SFE	--	4 Amp
2418E	2	SFE	--	9 Amp
2419E	2	SFE	--	14 Amp
2420E	2	SFE	--	20 Amp
2421E	2	SFE	--	30 Amp
2424E	2	GBC	--	5 Amp
2425E	2	GBC	--	8 Amp
2427E	2	GBC	--	16 Amp
2428E	2	GBC	--	25 Amp



### Blade Style-Closed Case

Part #	Pcs	Type	Color	Rating
2430E	2	ATC	Purple	3 Amp
2431E	2	ATC	Gold	5 Amp
2432E	2	ATC	Brown	7.5 Amp
2433E	2	ATC	Red	10 Amp
2434E	2	ATC	Blue	15 Amp
2435E	2	ATC	Yellow	20 Amp
2436E	2	ATC	Clear	25 Amp
2437E	2	ATC	Green	30 Amp



### Maxi - Fuses

Part #	Pcs	Type	Color	Rating
20310F	1	--	Yellow	20 Amp
20311F	1	--	Green	30 Amp
20312F	1	--	Orange	40 Amp
20313F	1	--	Red	50 Amp
20314F	1	--	Blue	60 Amp
20315F	1	--	Natural	80 Amp



### Mini Fuses

Part #	Pcs	Color	Rating
20300F	2	Gray	2 Amp
20301F	2	Violet	3 Amp
20302F	2	Pink	4 Amp
20303F	2	Tan	5 Amp
20304F	2	Brown	7.5 Amp
20305F	2	Red	10 Amp
20306F	2	Blue	15 Amp
20307F	2	Yellow	20 Amp
20308F	2	Clear	25 Amp
20309F	2	Green	30 Amp



### PAL Female Fuses

Part #	Pcs	Color	Rating
20326F	1	White	20 Amp
20316F	1	Pink	30 Amp
20317F	1	Green	40 Amp
20318F	1	Yellow	60 Amp



### PAL Straight Male Fuses

Part #	Pcs	Color	Rating
20319F	1	Pink	30 Amp
20320F	1	Yellow	60 Amp
20321F	1	Black	80 Amp



### PAL Bent Male Terminal

Part #	Pcs	Color	Rating
20322F	1	Pink	30 Amp
20323F	1	Green	40 Amp
20324F	1	Brown	70 Amp

### Fuse Kit Assortments

Part #	Pcs	Description
2475F	6	ATC Kit
2476H	6	American Car Kit
2477H	6	German Car Kit
2478H	6	British/Japanese Kit



## Inline Glass Fuse Holders

Part #	Pcs	AWG	Description
2465F	2	16	Fuse not included
2466F	1 Set	12	15A fuse & 2 butts
2467F	1 Set	12	20A fuse & 2 butts
2468F	1 Set	10	30A fuse & 2 butts
2526H	2	16	14A fuse
2527H	2	12	30A fuse



## Inline ATC/ATO Blade Fuse Holders

Part #	Pcs	AWG	Description
2528H	1	16	1A - 20A ATC fuses
2529H	1	12	1A - 30A ATC fuses
1232H	2	18 -14	Self-stripping ATC fuse holder 1-20A
2470F	2	18	Protective cap with 5A ATC fuse
2524F	2	12 -18	30A/32V waterproof
20325F	1	12	9" leads 3A - 30A silicone rubber water proof seal, nylon body w/latching cap



## Automotive Flashers



**2457F** (536/552) Replaces 12-Volt, two-terminal Flashers. Flashes two to three 32 C.P. standard or long-life lamps for turn signals. Flashes two to six lamps for hazard warning.



**2458F** (550) Replaces most 12-Volt, three-terminal flashers as used on Import cars and U.S. trucks. Separate pilot circuit.

## Fuse Blocks



**2450F** Four Position Glass Fuse Block. Each holder has two .250 tabs for connection.



**2452F** Four Position Junction Block. Each holder has two screws for connection.

## Fuse Adapters

Part #	Pcs	Description
1208B	3	ATC/ATO Fuse
1208C	100	power tap .250 tab
1208H	10	
1210C	100	Mini fuse power tap
1210H	10	.187 tab
1212B	4	Glass fuse power tap
1212C	100	tap .250 tab
1212H	19	

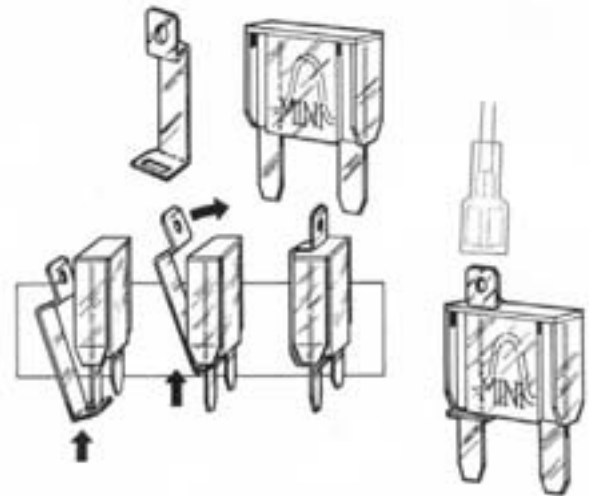

## Fuse Puller Tool



**2490F** Handy Fuse Puller for Glass type & blade style fuses.



**Ordering is easy!**  
Electronic Data Interchange  
Phone, Fax, Email

## Trailer Products



**2479F**  
2 Ft. Extension - Must be used to adapt pickup plug to 4-wire trailer



**2480F**  
4 Ft. Harness with 6-wire connector must be used to adapt pickup plug to 6-wire trailer system.



**2491F**  
Vehicles with red turn signals, all years. Wire extends to 11 ft. 5-wire tow vehicle to 4-pole trailer.



**2502H**  
2-Pole molded connectors for C.B. radio hook-ups, utility lights and accessories. Polarized plugs and color-coded wire.

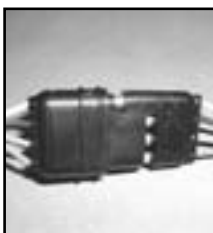

**2503H**  
3-Pole molded connectors for C.B. radio hook-ups, utility lights and accessories. Polarized plugs and color-coded wire.



**2504H**  
4-Pole molded connectors for C.B. radio hook-ups, utility lights and accessories. Polarized plugs and color-coded wire.



**2504-1F**  
6 Round to 4 Flat Adapter



**2504-2F**  
7 Round to 4 Flat Adapter



**2505F**  
48" Female 4-pole molded plug for trunk (tow vehicle) and 8" male molded plug lead for trailer connection. Polarized, color-coded & includes 3 wire connectors.



**2506F**  
4-Pole wiring kit with 24 ft. looped harness. Molded, polarized plugs & color-coded wires. Includes 8 wire connectors.



**2507-1F**  
Trailer 4-pole plug.



**2507-2F**  
Chrome Metal Female 4-Pole Replacement Plug.



**2507-3F**  
Chrome Metal Male 4-Pole Replacement Plug.



**2508-1F**  
Chrome Metal 6-Pole Male/Female Replacement Plug Set.



**2508F**  
6-Pole Chrome Trailer Connector Kit Chrome ABS plastic, die-casted 6-pole male/female plugs w/metal mounting bracket. Six color coded wires & 5 wire connectors included.



**2508-2F**  
Female Replacement Plug  
6-Pole Chrome Replacement Plug  
ABS plastic.



**2508-3F**  
Chrome Metal Male 6-Pole Replacement Plug.



**2509F**  
Converts 5-wire (amber turn signal) system to 4-wire trailer lighting system.



**2511F**  
Male/Female polarized round style plug set for some boat trailers.

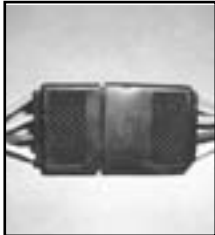

**2512F**  
4-Pole moisture proof style trailer connector for C.B. radio hook-up, utility lights & accessories. Polarized plugs & color-coded.



**2513F**  
5-Pole "Moisture Proof" Connector Male/Female Set 5-Pole moisture proof style trailer connector for C.B. radio hook-up, utility lights & accessories. Polarized plugs & color-coded.



**2514F**  
6-Pole "MoistureProof" Connector Male/Female Set 6-Pole moisture proof style trailer connector for C.B. radio hook-up, utility lights & accessories. Polarized plugs & color-coded.



**2515F**  
Harness 4-Pole Female molded plug w/3 wires 48" length & an 18" ground wire for trunk harness replacement.



**2516F**  
Trailer Replacement Harness 4-Pole Male, 4-Pole plug w/ all 18" wires for trailer wire replacement.



**2518F**  
Universal 18" Trailer 4-way to 4-way wiring adapter harness w/ all wires 8" lengths, and bullets / receptacles in places, ready to go.

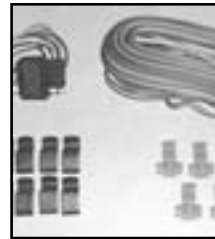

**2517F**  
Wishbone 5-Wire Trailer Wiring Kit 25-FT wishbone style 5-wire to 4-wire trailer harness w/ molded plug. 4-ft. trunk wire harness. 2-wire connectors & 8 frame clips all included. 5th wire allows for utility and running light



**2522F**  
4-Way Trailer Ribbon Wire Four bonded. Parallel primary, color-coded wires (green, yellow, brown & white) in 25 ft. length, 16 AWG.



**2523F**  
3-Way Trailer Ribbon Wire Three bonded. parallel primary, color-coded wires (green, yellow, & brown) in 25ft. length.



**2560F**  
1157 bulb, adapted w/leads for easy tap-in from tow vehicle tail light.

**Trailer lights wiring using JT&T 2505F harness**

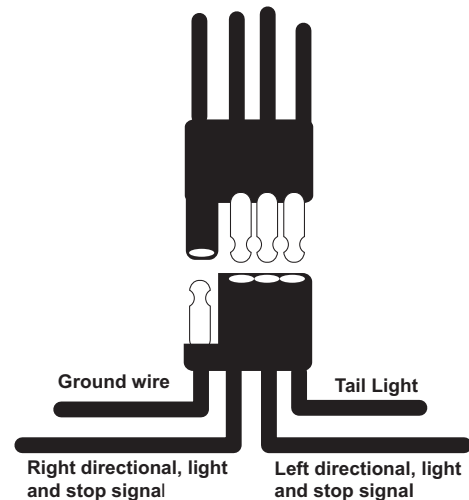



**Ordering is easy!**  
Electronic Data Interchange  
Phone, Fax, Email



**2500H**  
**90° Female Receptacle**  
Special 90° angle plug used for brake light sending unit or engine block heat sensor. Molded moisture proof. Mates with .157 to .159 male



**2440F**  
**GM Marker Lamp Pigtail Socket**  
Assembly fits GM 88 & up replaces GM #12083007 AC/Delco LS13



**2525F**  
**Universal shielded license/utility light.**  
Fits 1-1/4" knock-out on truck bumpers.



**2441F**  
**GM Side Marker Pigtail Socket**  
Assembly fits GM 1984 & up. Mfg. #GM 12037105, 12083460 Lamp #24 miniature wedge base



**2530H**  
**GM Alternator Repair Harness**  
Fits GM cars 1971-on w/ transistorized alternators w/ internal regulator. For extender see #2541. Replaces GM 6294493



**2443F**  
**GM Signal & Parking Light Socket**  
Twist Fits GM products 1988 & up Replaces GM 12083006, Delco LS12



**2531H**  
**GM Alternator Pigtail** Fits GM Cars 62-74 w/ non transistorized alternators with external regulators For alternator harness extender see 2542F Replaces GM 2977373



**2444F**  
**GM Signal & Parking Light Socket**  
Fits GM 88 & up replaces GM #12083005 AC/Delco LS12



**2532H**  
**Ford Alternator Repair Harness**  
Alternator repair harness for Ford 1965 and up and VW to 1978.



**2445F**  
**Ford Signal and Parking Socket**  
Mfg # Ford D4ZZ-13234-A for Ford Products 1974-80. Use lamp #1157 for parking



**2533H**  
**Chrysler Voltage Regulator**  
repair harness for 1965 & up and VW to 1976.



**2446F**  
**Ford Signal & Parking Light Socket**  
Fits Ford products 1988 & up. Replaces Ford D4OZ-13234A



**2534F**  
**Pigtail Socket Assembly**  
Mfg #Ford D3AZ-13410-G for Ford products 1973-80. Use lamp #1157 for stop/tail lamps.



**2447F**  
**Ford Park & Turn Socket Assembly**  
Replaces Ford #E1FZ-19234A. Fits 1977-93. Lamp #1157



**2535F**  
**Pigtail Socket Assembly**  
Mfg # Ford D1FZ-13234-A for Ford products 1973-84. Use lamp #1157 for parking lamp.

wiring accessories master catalog rev704



**2536J**  
**Signal/Park/Stop & Tail**  
 Double Contact Ford socket assembly w/ ground bracket, 1962-68. Lamp #198, 1016, 1034, 1154, 1157. Fits 3/4" hole.



**2537H**  
**Dimmer Switch Pigtail** for GM & Ford 1960-1976. Used on manual air conditioner relay. AMC 1967-on, Chrysler 1971-on & GM 1957-on. Mfg. #Delco D803, D808-replaces CZVY-13A024-A



**2538H**  
**Dimmer Switch Pigtail** For Chrysler, Ford & AMC Mfg. #Mopar 1881938, 2497158 Motorcraft SW263 AMC 3160926

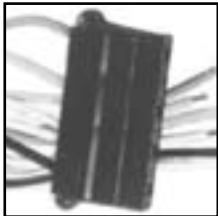

**2539H**  
**Voltage Regulator Repair Harness**  
 For Ford & AMC 1965 & up w/ Ford regulator. Mfg. # Ford GR341, GR 341A, fits GR503 regulators.

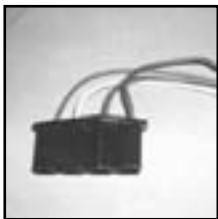

**2540H**  
**Voltage Regulator Repair Harness**  
 For GM 1962 & up and all AMC w/Delco regulator #D635. Mfg #GM 2977607



**2541H**  
**GM Alternator Extender Harness**  
 for GM transitorized system 1965 and up. Also for rebuilds and off-brand alternators where normal harness will not reach. Replaces 6294493 - fits Delco 7731



**2542H**  
**GM Alternator Extender Harness**  
 For GM Delcat system 1965 & up. Also for rebuilds and off-brand alternators where normal harness will not reach. Eliminates need for re-clocking alternator.



**2543F**  
**GM Radio Power Adapter**  
 GM Delco radio 1978-84. Not supplied by original equipment.



**2544F**  
**Radio Front Speaker Adapter**  
 GM Delco radio 1978-84. Not supplied by original equipment.

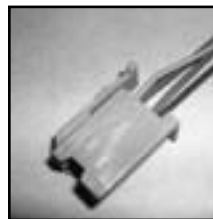

**2545F**  
**Radio Rear Speaker Adapter**  
 GM Delco radio 1978-84. Not supplied by original equipment.



**2546F**  
**Universal Double Contact Socket**  
 Signal, park, stop & tail. Offset mounting screw type. Lamp #198, 1016, 1034, 1154, 1157



**2547H**  
**Side Marker Socket**  
 marker for Chrysler products. 1974-83. Mfg.#3588314, 3588650 Lamp #194, 194A



**2548H**  
**Side Marker Socket**  
 marker for Chrysler products. 1972-85. Mfg.#3513386, 4055028 Lamp #194, 194A



**2550F**  
**Double Contact Side Marker Socket** GM 1974 & up for side marker, license & park. Mfg # GM 8912750 Lamp #194, 194A.

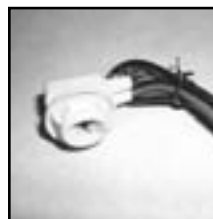

**2551F**  
**GM 90° Angle Side Marker** GM Products 1975 & up for rear license, cornering lamp, tail & stop. Replaces 12001470 Delco LS-5



**2552H**  
**Pigtail Socket Assembly** Ford, front park & turn. Mfg. #D3MY-13410A Lamp #1157



**Ordering is easy!**  
Electronic Data Interchange  
Phone, Fax, Email



**2553F**  
**GM Double Contact Socket**  
GM Products 71 & up for stop, tail & turn. Mfg. #8909517 Use lamp #1034, 1154, 1157.



**2554F**  
**GM Double Contact 90° Socket**  
Products 1976-88. 1" focal length. Stop, tail, turn & backup. Mfg. #GM 12003759 Lamp #1034, 1154, 1157 AMC 8218931, Delco L\$-7



**2555F**  
**GM 3-way Double Contact Socket**  
Assembly Stop, tail, park & turn for Chevrolet 1975 & up. Mfg. #GM 12013813, 8919916 Lamp #1034, 1154, 1157.



**2556H**  
**Standard Double Contact Pigtail**  
Pigtail wire assembly w/fiber washer. Lamp #64, 68, 82, 88, 90, 94, 210, 1004, 1034, 1074, 1130, 1154, 1157, 1158, 1176.



**2556-1H**  
**Universal Double Contact Weather Proof Pigtail** Lamp #64, 68, 82, 88, 90, 94, 1004, 1034, 1074, 1130, 1154, 1157, 1158, 1176



**2557-1H**  
**Universal Single Contact Weather Proof Pigtail** Lamp #63, 67, 81, 87, 93, 209, 1003, 1073, 1129, 1133, 1141



**2557H**  
**Universal Single Contact Pigtail**



**2557-2H**  
**Universal Single Contact Pigtail**  
For miniature Base Lamps Lamp #51, 53, 55, 57, 57X, 1895



**2558H**  
**Universal Single Contact Socket**  
Assembly Single contact socket for dome, map, glove box. Lamp #63, 67, 81, 89, 209, 1073, 1129,



**2559H**  
**Universal Double Contact Socket**  
Assembly Double contact socket for signal, park, stop & tail, dome, map, etc. Fits offset pin bulbs. Lamp #198, 1016, 1034, 1054, 1057.



**2561H**  
**Universal Double Contact Socket**  
Assembly Doublecontact socket w/spring clip mount for park, stop & tail, license plate, instrument panel assembly. Fits 7/8" to 1-1/8" hole. Lamp #198, 1016, 1034, 1154, 1157



**2562H**  
**Universal Single Contact Socket**  
Assembly Single contact socket w/spring clip mount for turn, park, stop & tail assembly. Fits 7/8" to 1-1/8" hole.



**2563H**  
**Universal Miniature Base Single Contact Socket** Miniature single contact socket. Snap-in assembly fits 5/8" hole for instrument panel or where mini-bulbs are used. Bulb# 51, 53, 55, 57, 57x



**2564H**  
**Sealed Beam Headlight Connector w/3 wires**  
For 3 prong sealed beams or 3 prong flashers. Fits lamp 4001



**2565H**  
**Sealed Beam Headlight Connector w/2 wires** For 2-prong sealed beams or 2-prong flashers. Fits lamp #4001

wiring accessories master catalog rev704





**2566F**  
**Universal Single Contact Assembly**  
 for GM, Signal, Park tail light socket w/neoprene boot and adapter plate. Fits 3/4" hole. Lamp#63, 67, 81, 87, 93, 209, 1003, 1073, 1129, 1131, 1133, 1141



**2574F**  
**Chrysler Single Contact Socket Assembly** w/neoprene boot. Fits all Chrysler products 1971 & up. Mfg. #3764863 Lamp #63, 67, 81, 87, 89, 93, 209, 1003, 1073, 1129, 1133, 1141



**2567F**  
**Double Contact Socket Assembly w/ground wire and mounting plate.** Stop, tail, turn and parking light socket w/neoprene boot & adapter plate. Fits 3/4" hole, GM, Chrysler products. Lamp 198, 2026, 1034, 1154, 1157.



**2575F**  
**Chrysler Double Contact Socket Assembly** w/neoprene boot. Fits all Chrysler products 1972 & up. Mfg. #3764865, 3843245, 4124721, 4163003 Lamp #87, 93, 198, 1016,



**2568H**  
**Single Contact Socket for GM Products.** For license plate and instrument panels, snap-in socket. Fits 3/4" hole. Lamp # 63, 67, 81, 89, 1002, 1129, 1133, 1141



**2576H**  
**GM Dimmer Switch Harness**  
 For floor mounted dimmer switch GM 1960-76. Use with Delco switches: D803, D809



**2569F**  
**Universal Double Contact Assembly**  
 For park, stop, tail and turn. Snap in socket fits 3/4" hole. Lamp 198, 1016, 1034, 1154, 1157



**2577F**  
**Universal Single Contact Socket Assembly** License, park, stop & tail lights. Snap-in fits 1-1/8" hole. Lamp #63, 67, 81, 87, 89, 93, 209, 1003,



**2570F**  
**Universal Double Contact Assembly**  
 For park, stop, tail. Exact replacement for original on 1963-77 vehicles - AMC 4486948, GM 6299087, 8912698, 2974309, 2983540 Delco LS-3 - Bulb # 198, 1016, 1034, 1154, 1157



**2578F**  
**GM & Ford Double Contact Socket**  
 Prong Type Stop & tail on Ford. w/ground tab. For turn, park, stop & tail. Snap-in socket. Fits 1-1/8" hole. Mfg. #AMC 4488908; Ford D1AZ-13410-B, D0AZ-12300B



**2571H**  
**Universal Single Contact Backup Light**  
 Exact replacement for the original socket.



**2579F**  
**GM Single Contact Back-Up Light**  
 Assembly GM back-up light for 1-1/8" hole. Mfg. #GM 8903205, 2978302 Lamp #63, 67, 81, 87, 89, 93, 209, 1003, 1073, 1129, 1133,



**2572F**  
**GM 3-Wire Socket Assembly**  
 Twist-lock type for stop & tail on GM vans 1969 & up. Focal length 7/8". Replaces grey OEM type.



**2580F**  
**3-Wire Twist Lock Socket Assembly**  
 GM stop & tail Light. Twist-Lock type. Focal length 7/8". Mfg. #GM 8903202, 8914822 Lamp #1034, 1154, 1157



**2573F**  
**GM Double Contact Socket Assembly** For signal, park, stop & tail. GM flush mount snap-in. Fits 1-1/8" hole. Mfg. #GM 5947900 Lamp #198, 1016, 1034, 1154, 1157



**2581F**  
**Universal Double Contact Socket Assembly** For turn, park, stop & tail.



**Ordering is easy!**  
Electronic Data Interchange  
Phone, Fax, Email



**2588-1F**  
**Halogen Headlight Connector**  
High Beam Lamp #9005 1201898



**2582F**  
**GM Socket Assembly**  
w/90° Angle for back-up, cornering, park, stop & tail. GM products 1977 & up. Focal Length 1-1/4" Mfg. #GM 12003758 Lamp #1003, 1129, 1133, 1141, 1156



**2588-2F**  
**Halogen Headlight Connector**  
Low Beam Lamp #9006 1201897



**2583F**  
**GM & AMC Socket Assembly**  
w/ 90° Angle For turn, park, stop & tail. Focal length 1-1/4" Mfg. #AMC 8128931 #GM 12003757 dELCO Is-6 Bulb # 1034, 1154, 1157



**2588-3F**  
**GM Repair Harness -**  
Brake, Temp, Horn, Speed, Trunk, Lid OEM 12116958



**2584F**  
**GM 3-Wire Twist Lock Type Socket**  
For turn, park, stop & tail. Focal length 1-1/4".Mfg. #GM 8903203, 8914823



**2589F**  
**GM Back-up Light Socket Assembly**  
Single contact back-up light socket w/ground wire. GM products 1973 & up. Mfg. #GM 59663268, 8904437, 8909518 #IHC 571721C91 Lamp #1156



**2585H**  
**2-Wire Relay Connector Connects**  
relays to heater, air conditioner, window washer & wiper for GM, Ford & Chrysler products. DO NOT use to replace connector w/integral diode.



**2590H**  
**GM & Ford Side Marker Socket**  
Assembly Fits license plate, side marker & cornering. Fits most U.S. manufactured vehicles from 1968 & up. Mfg. #AMC 4489395 Ford D4OZ-13410E, D7AZ-13412A8901283



**2586F**  
**GM Single Contact Socket Assembly**  
For back-up, cornering & turn signal. Fits GM products 1977 & up. Mfg. #GM 12003878 Lamp #63, 67, 81, 87, 89, 93, 209, 1003, 1073, 1129,



**2591F**  
**Single Contact Socket Assembly**  
w/Butt Terminated Wires. Back-up & Rear. Fits Ford products 1973 & up. Mfg. #D1AZ-13410B, D3AZ-13410A Lamp #1156



**2587F**  
**Chrysler Signal Stop & tail Light Socket**  
stop & tail light. Mfg. #3843432, 4163003, 3843245, 4362469 Lamp #198, 1016, 1034, 1157, 1157



**2592F**  
**Double Contact Socket Assembly w/Butt Terminated Wires.** Rear lamps for Ford 1973 & up. Also fits AMC & Chrysler. Mfg. #AMC 3690736, 8124663 Chry. 3588833, 3764123 Ford D3AZ-13410B, D4ZZ-



**2588F**  
**3-Pole Halogen Headlight Connector**  
Lamp #9004 & 9007  
Mfg. #12048369



**2593F**  
**Double Contact Universal Socket**  
Stop, tail, turn & park. Double contact prong-type assembly w/male blade ground terminal complete w/ground lead. Fits 1-1/8" hole on most Ford & some Chrysler products. Mfg. #Ford D0AZ-13410B, D1AZ-13410B, D2OZ-13410B. Lamp #1034, 1154, 1157.



**2594F**  
**Double Contact Socket w/Butt Connectors** Rear tail lamp.  
 Fits Ford products 1973 & up. Mfg. #D3AZ-13410D, D4SZ-13410E, D4OZ-13410A. Lamp #1034, 1157



**2595F**  
**Weatherproof Stop, Tail, Turn & Park Double Contact** Turn, park, stop & tail w/weatherproof neoprene covering. Fits most Ford products Lamp #198, 1016, 1034, 1154, 1157



**2596H**  
**Ford Weatherproof Single Socket** Turn, park, stop & tail w/weatherproof neoprene covering. Fits most Ford products Lamp #63, 67, 81, 87, 89, 93, 209, 1003, 1073,

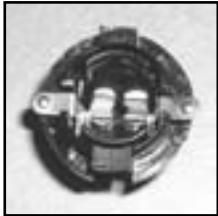

**2597H**  
**Instrument Panel Socket w/Vinyl Housing** size 5/8" for AMC, Chrysler, GM, IHC. Mfg. #GM 2973932, 5655006 Chrysler 249627 AMC 3509575 IHC 374985C91 Lamp #168, 194, 1895



**2598H**  
**Instrument Panel Socket w/Vinyl Housing** 1/2" for Ford products, GM, Chrysler 1955 & up. Mfg. #Ford C8OZ-13711A, E7G2-13711A GM 12004311, 25015169 Chrysler 3744750 Lamp #168, 194, 194A



**2599F**  
**Universal Double Contact Socket** Weather-resistant - For signal, park, stop & tail light. Double contact w/ground wire. Mounting plate 1-1/4" x 1-3/4" Lamp #1034, 1154, 1198, 1016, 1157, 1198, 1016, 1157



**2800F**  
**Ford Alternator Harness**  
 Models 1981-1989



**2801F**  
**GM Alternator Connector**  
 Fits all GM 71-80, Delco models 10SI, 12SI, 15SI & 27SI Replaces GM12101909, Delco PT181 Two 10", 16GA leads



**2802F**  
**Idle Air Control Connector Pigtail.**  
 Fits 25533222 Idle Air Control Motor Replaces GM 12085506 AC/Delco PT127



**2803F**  
**Coolant Sensor Connector** GM products 1985 & up Replaces GM 12085488 AC/Delco PT110

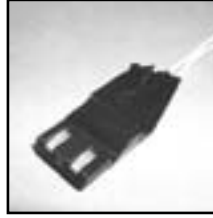

**2804F**  
**AC Compression Harness w/Diode**  
 GM 12101907



**2805F**  
**Coolant/ MAT Sensor Connector**  
 Fits GM products 1990 & up Replaces GM 12085524 AC/Delco PT134

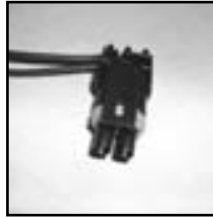

**2806F**  
**Mixture Control Solenoid Connector Pigtail**  
 Fits GM 17067344 and 17111102 Mixture Control Solenoid Kits, 1980-1990 Not Available from GM or



**2807F**  
**Throttle Position Connector Pigtail**  
 2 & 4 Barrel Rochester Carburetors 12116257



**2808F**  
**Coolant Temperature Sensor Pigtail**  
 Replaces GM 12102621



**2809F**  
**Choke Pigtail**



**Ordering is easy!**  
Electronic Data Interchange  
Phone, Fax, Email



**2810F**  
**Direct Ignition, Throttle Body Injection Pigtail**  
Replaces GM 12085496 AC/Delco PT 118



**2811F**  
**Manifold Absolute Pressure (MAP) Connector Pigtail**  
Fits 16137039 MAP Sensor  
Replaces GM 12085502 AC/Delco PT123

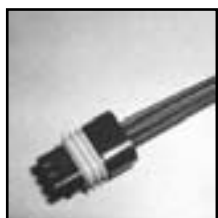

**2812F**  
**Crankshaft Coolant Sensor Pigtail**  
also used as P/S pressure switch and coolant sensor connector  
Replaces GM 12085483 AC/Delco PT105

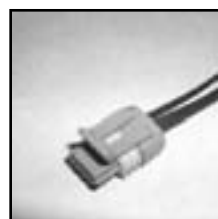

**2813F**  
**Camshaft Sensor Connector Pigtail**  
Replaces GM 12085538 AC/Delco PT 148



**2814F**  
**Air Conditioner Pressure Switch Connector Pigtail**  
Replaces GM 12085507 AC/Delco PT128



**2815F**  
**A/C High Pressure Cut-Out / Fan Control switch pigtail**  
replaces GM 12085521 AC/Delco PT131



**2816F**  
**A/C Compressor low pressure pigtail**  
Replaces GM 12085503 AC/Delco PT 124



**2817F**  
**A/C Compressor Clutch Pigtail**  
Replaces GM 12101937 AC/Delco PT 20



**2818F**  
**Heater Blower Connector Pigtail**  
Replaces GM 12101906 AC/Delco PT173

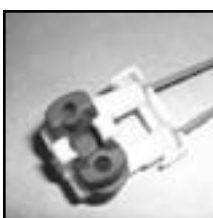

**2819F**  
**TBI (Throttle Body Injector) Connector Pigtail**  
Replaces GM 12102568 AC/Delco PT285



**2820F**  
**Fuel Injector Solenoid Connector Pigtail**  
Replaces GM 12085491 AC/Delco PT113



**2821F**  
**Oxygen Sensor Connector Pigtail**, sealed not supplied by GM 12117385



**2822F**  
**Distributor Module Pigtail**, sealed 4 wire. One of two pigtails that plug into GM 1987466, 12126487



**2823F**  
**Oil Pressure Connector Pigtail**  
Replaces GM 12085499 AC/Delco PT121



**2824F**  
**Coolant Temperature Sensor (Radiator)** Additional Applications: Brake Fluid & Washer Fluid Sensor Ignition Module Replaces GM 12101899 AC/Delco PT 169

wiring accessories master catalog rev704



**2825F**  
**MAT Sensor Connector Pigtail**  
 Replaces GM 12102620  
 AC/Delco PT 307



**2826F**  
**Washer Fluid Sensor Pigtail**  
 Back up Lamp Switch Connector  
 A/C Compressor Switch Replaces  
 GM 12101903 AC/Delco PT175



**2827F**  
**Windshield Washer pump / Low  
 Coolant Sensor pigtail** (sensor  
 applications reference vehicle engine  
 type)



**2828F**  
**Ford Regulator Socket Assembly**  
 Internal Voltage Regulator.  
 w/10" leads, 1-14 AWG lead, 2-20  
 AWG leads. Fits Topaz, Tempo,  
 Sable & Taurus 1986 - on.



**2829F**  
**Ford Air Conditioner  
 Clutch Pigtail** w/12"  
 Leads not supplied  
 by OEM. Fits Ford  
 products.



**2830F**  
**Ford Ignition Coil Pigtail** not sup-  
 plied by OEM w/color-coded wires,  
 10", 2-18 gauge, 1-16 gauge Fits  
 Ford coil E73Z-12029A



**2831F**  
**Ford Radiator Fan Pigtail Socket  
 Assembly** w/12" Leads not supplied  
 by OEM. Radiator cooling fan motor  
 Ford 4 cyl. 1979. Ford truck, pickup  
 & vans 1982-86.



**2832F**  
**Ford Electronic Module Socket &  
 Wire Assembly** (Gray) Fits module  
 E.E.C. IV ignition neutral safety  
 switch (E8OZ-7A247A) 1988-  
 6 leads, 8" length



**2833F**  
**Ford Electronic Module Socket &  
 Wire Assembly** (Black) not supplied  
 by OEM. Fits module (E8TZ-  
 12A297A) 6 leads, 8" length, 14  
 gauge wire.



**2834F**  
**Ford Fuel Pump Relay Repair  
 Harness** not supplied by OEM.  
 Fits relay E3FZ- 9345B7-18 GA  
 leads plus 1-18 GA lead 8" GLX  
 wire.



**2835F**  
**Ford Engine Fan Switch Repair  
 Harness** not supplied by OEM.  
 2 -14GA, 7" leads, black connector  
 Fits switch #s E5SZ-8B607A, E4FZ-  
 8B607A Ford Products 1985 - on.



**2836F**  
**Ford Engine Fan Switch Repair  
 Harness** not supplied by OEM  
 Fits switch E43Z8B607-A 2-14 GA,  
 8" leads-Gray Connector



**2837F**  
**Ford Engine Fan Speed Switch  
 Repair Harness** Taurus/Sable,  
 1986-93. T-Bird / Cougar, 1989-93.  
 E-Series Van, 1992. Fits switch #s.  
 E6DZ-19986A, E9SZ-A, F2DZ-A,



**2839F**  
**Universal Double Contact Socket  
 w/Bracket**



**2840F**  
**Universal Single Contact Snap-In  
 Socket**



**2841F**  
**GM Alternator Connector Pigtail**  
 3-Wire for 87-90 Cadillac, Buick,  
 Chevrolet, Oldsmobile. Replaces  
 GM12101895, Delco PT165



**Ordering is easy!**  
Electronic Data Interchange  
Phone, Fax, Email



**2870F**  
**Double Contact Stop, Tail, Lamp**  
87-93 Replaces GM1203055, Bulb 1157/A



**2871F**  
**Double Contact Backup, Stop, Tail, Turn** - Replaces GM12076946, 89-93 Bulb 1157



**2872F**  
**Double Contact Backup, Stop, Tail and Turn** - Replaces GM 12083680, Bulb 3057 90-93



**2873F**  
**Double Contact Park, Stop, Tail, Turn** - Replaces GM 12083689, Bulb 3057



**2874F**  
**Double Contact Backup, Drive, License**, - Replaces GM 12085330, Bulb 3057 88-93



**2878F**  
**Rear Lamp, Stop, Tail & Turn** - Replaces Chrysler 4450815



**2880F**  
**License Plate Lamp**  
Replaces Chrysler 4414184



**2882F**  
**GM Double Contact Socket**  
License, Park, Side Marker  
Replaces GM 8912750



**2883F**  
**Socket Repair Assembly**  
Replaces FORD ESPZ-13411B 83-95



**2884F**  
**Ford Light Socket** Rear Stop, Tail, Turn Front Park/Turn 1987-90



**2885F**  
**Ford Light Socket** Rear Stop, Tail, Turn Front Park/Turn 1987-91



**2886F**  
**Ford Light Socket** Rear Stop, Tail, Turn Front Park/Turn 1987-94



**2888F**  
**Ford Oxygen Sensor Repair Harness**  
Black connector 1986-on



**2889F**  
**Ford Oxygen Sensor Repair Harness**  
Grey connector 1985-92



**2890F**  
**GM Oil Pressure Switch Connector**  
1987-95 GM 12085539

wiring accessories master catalog rev704



**2891F**  
**GM Throttle Position Sensor Connector**  
 1990-94GM 12102748



**2892F**  
**GM Map, Mass Air Flow Sensor Connector** 1985-89 GM 12085497

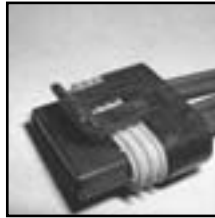

**2893F**  
**GM Direct Ignition Connector** 1987-89 GM 12101880



**2894F**  
**GM Mass Flow Air Connector**  
 GM 12085495 88-90



**2895F**  
**GM Mass Flow Air Sensor Connector**  
 GM 12085492 1986-89



**2896F**  
**GM Direct Ignition Vehicle Speed Sensor** GM12101855



**2897F**  
**GM Fuel Pump & Instrument Panel Pigtail** GM 12117353

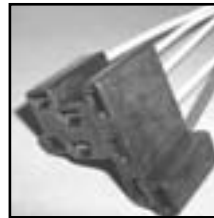

**2898F**  
**GM Headlamp Switch Connector** 1977-91 Fits Switch 1995217



**2899F**  
**Ford Mass Air Flow Sensor**  
 repair harness-fits coil F0TZ-12029-A, F1SZ-12029-A

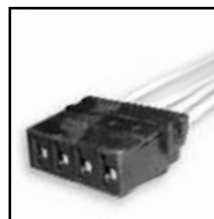

**2899-1F**  
**Ford Fan Switch Repair Harness**  
 12085487

### JT&T Applications Guide

Easily find the light socket or pigtail harness you need by make, model and year. The JT&T applications guide is available by mail or download it on our website at [www.jttproducts.com](http://www.jttproducts.com)



### 519H

**Small Frame Clips** -Spring steel push-on wire clips for securing wiring inside automobile chassis.



Part #	Pcs
519H	7



**Ordering is easy!**  
Electronic Data Interchange  
Phone, Fax, Email

### Illuminated Duckbills [S.P.S.T 20A @ 12 Volt]



Part #	Description
2622J	red on-off
2625J	green on-off
2626J	blue on-off
2627J	amber on-off
2610H	black on-off (non-illum)

### Illuminated Toggles [S.P.S.T 20A @ 12 Volt]



Part #	Description
2612J	red on-off
2615J	green on-off
2616J	blue on-off
2617J	amber on-off
2620F	black on-off-on S.P.D.T. (non-illum)
2630F	black mom. on-off (non-illum)
2640H	black on-off (non-illum)

### Bakelight Toggles [15A @ 12 Volt]



Part #	Description
2641F	on-off 2 screw terminals
2941F	on-off integrated wire leads

### All Weather Toggles [25A @ 12 Volt]



Part #	Poles	Description
2654J	S.P.S.T.	on-off metal
2655F	S.P.S.T.	mom. on-off metal
2656F	D.P.S.T.	on-off 4-terminal.
2657F	D.P.D.T.	on-off-on 6-terminal
2658F	S.P.D.T.	20A mom on-off. mom on

### Illuminated Rockers [16A @ 12 Volt - S.P.S.T.]



Part #	Description
2602J	red
2605J	green
2606J	blue
2607J	amber
2600J	black (non-illum)

### Heavy Duty Toggles



Part #	Poles	Rated	Description
2642F	S.P.S.T.	25A	on-off 2 screws
2643F	S.P.D.T.	25A	on-off marine 3 screws
2644F	S.P.D.T.	25A	on-off-on marine 3 screws
2645F	D.P.S.T.	30A	on-off 4 screws
2646F	D.P.D.T.	25A	on-on 6 screws
2647F	D.P.D.T.	30A	on-off-on 6 screws
2648F	D.P.S.T.	30A	mom. on-off mom. on 6 screws
2649F	S.P.S.T.	20A	on-off 1-1/2" long handle 2 screws



**LED  
Rockers**  
[S.P.S.T.]

Part #	Amps	Description
2609H	16	black standard
2618F	10	black miniature

### Push-Pull Euro Switch



Part #	Amps	Description
2910F	16	push-pull on-off



**Illuminated  
Jumbo  
Rockers**

[16A @ 12 Volt - S.P.S.T.]

Part #	Description
2902F	red
2905F	green
2906F	blue
2907F	amber
2900F	black (non-illum)

### All-Metal Toggles



Part #	Amps	Description
2913F	50	metal on-off
2918F	50	metal on-off-on
2653J	20	on-off 2 screw terminals



### Light & Rocker Combination

[16A @ 12 Volt]



Part #	Description
2603F	Amber
2604F	Red

### Illuminated Push-Pull Switches

[15A@12 Volts]



Part #	Description
2670F	Red
2965F	Green
2966F	Blue
2967F	Amber

### Horn Buttons [5A @12 Volt]



Part #	Description
2689F	Flush mount
2689-1F	Column mount includes bracket



### Warning Lights w/Lucar Terminals

[16A @ 12Volt]



Part #	Description
2632H	Red
2635H	Green
2636H	Blue
2637H	Amber

### Warning Lights w/ Leads 1/2"

[16A @ 12Volt]



Part #	Description
2672F	Red
2673F	Green
2676F	Blue
2677F	Amber
2633F	Red - 1/4" mount

### Heavy Duty Push-Pull Switches [16A@12 Volt]



Part #	Description
2690F	Universal on-off w/5/8" mounting stem for 1" panel.
2691F	Fused off-on-on three position ideal for headlamp operation 1/2" mounting stem.
2694F	Die Cast 75 Amp. Two position on-off. Chrome plated knob with 5/8" mounting stem, 15/32" dia. Excellent truck, tractor, industrial switch.
2695F	Ignition Switch-all screw terminals 4 position, molded base, lock tumbler, die cast housing. Fits panels 3/4" to 1" hole, 3/4" bushing. Includes 2 keys.

### Starter Switches



Part #	Description
2680F	10A @ 12V All brass with nickel plate facing. Mounting stem 5/8" dia. for 1" panel
2681F	60A @ 12V 40A @ 24 V Extra heavy-duty dust and moisture proof with 5/8" mounting stem, 5/8" dia., 1-3/16" length. Neoprene cap.
2683F	10A mom push red .250 tab terminals

### Switch/Panel Combinations



Part #	Description
2980F	Illuminated red rocker mounted on panel #2650E
2982F	Illuminated red toggle mounted on panel #2650E
2984F	Black toggle and red indicator mounted on part #2650F
2986F	Illuminated red and blue toggles mounted on part #2650F



**Ordering is easy!**  
Electronic Data Interchange  
Phone, Fax, Email

### LED Toggle



Part #	Description
2653-1J	15A Red LED on/off

### Oval Illuminated Rocker [16A @ 12Volt 1/2" Dia. ]



Part #	Description
2702-2J	Red on/off
2702-4J	Amber on/off
2702-5J	Green on/off

### Oval LED Rocker [16A @ 12Volt 1/2" Dia. ]



Part #	Description
2703-2J	Red on/off
2703-4J	Amber on/off
2703-5J	Green on/off

### Round Illuminated Rocker [10A @ 12Volt 1/2" Dia. ]



Part #	Description
2700-2J	Red on/off
2700-4J	Amber on/off
2700-5J	Green on/off
2700-6J	Blue on/off
2700J	Black (non-illuminated)

### Round LED Rocker [10A @ 12Volt 1/2" Dia. ]



Part #	Description
2701-2J	Red on/off
2701-4J	Amber on/off
2701-5J	Green on/off

### Toggle Switch Guard [fits standard 1/2" Dia. Stem]



Part #	Description
2652F	Red
2652-5F	Green
2652-6F	Blue
2652-7F	Yellow

### Round Panel Mounts [1/2" hole]



Part #	Description
2650E	1 - Round Hole
2950F	2 - Round Holes
2951F	3 - Round Holes
2952F	4 - Round Holes

### Rectangular Panel Mounts [7/16" x 1 1/8"]



Part #	Description
2651E	1 - Slot
2953F	2 - Slots
2954F	3 - Slots
2955F	4 - Slots

### Toggle Switch Boot [fits standard 1/2" switch stem]



Part #	Description
2659F	Weather Proofing Switch Boot for dust and moisture protection. Install over handle.

### Cigarette Lighter Power Adapter



Part #	Description
2675H	12 Volt Cigarette lighter adapter without leads

### Switch specifications

**S.P.S.T.** switch-single circuit control  
Single Pole Single Throw on/off

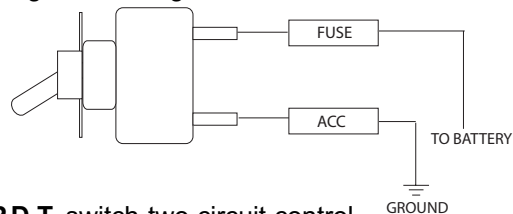

**S.P.D.T.** switch-two circuit control  
Single Pole Double Throw on/off/on

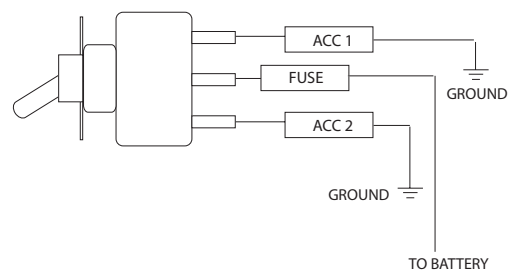

## Bulk Heat Shrink Tubing - Stick & Spool

JT&T's Irradiated, Flexible, Polyolefin Heat Shrink Tubing is intended for general purpose applications requiring recognition by military and industrial specifications. It is mechanically strong, flame retardant, and will not melt or split when shrunk over irregularly-shaped objects. Applications include jacketing wire bundles and light duty harnesses where superior abrasion resistance is a plus. Also used to identify and color-code electrical connections and wire bundles. This heat shrink is rated for continuous operation from -55°C to 135°C and up to 300°C for short durations. It is approved for UL and CSA usage.

UL/CSA	
Applicable Specifications:	MIL-1-23053B/5, Classes 1, 2 AMS 3636B, AMS 3637B
Operating Temperature Range :	-55°C to 135°C -67°F to 275°F
Shrink Ratio:	2 to 1 (50%)
Shrink Temperature:	121°C/250°F
Colors:	
Type 1	Flame-retardant:
Type 2.	Non- Flame-retardant: Standard Clear [1]
<b>For colors specify the following numbers:</b>	
0-Black	7-Yellow
1-Clear	5-Green
2-Red	6-Blue
	9-White
Example: Designate spool with an "S"	
	4008-0 = 3/4" Black Stick
	4008S-0 = 3/4" Black Spool

Part #	Expanded		Inside Diameter		Recovered Nominal Wall Thickness	Bulk Stick		Bulk Spools
	Fractional	Expanded	Recovered	Total Length		4' Pcs		
4000	3/64"	.046"	.023"	.016"	100'	25	1000'	
4001	1/16"	.063"	.031"	.017"	200'	50	1000'	
4002	3/32"	.093"	.046"	.020"	200'	50	500'	
4003	1/8"	.125"	.062"	.020"	200'	50	500'	
4004	3/16"	.187"	.093"	.020"	200'	50	500'	
4005	1/4"	.250"	.125"	.025"	200'	50	250'	
4006	3/8"	.375"	.187"	.025"	100'	25	200'	
4007	1/2"	.500"	.250"	.025"	100'	25	150'	
4008	3/4"	.750"	.375"	.030"	100'	25	250'	
4009	1"	1.00"	.500"	.035"	100'	25	250'	
4010	1 1/4"	1.25"	.625"	.035"	100'	25	150'	
4011	1 1/2"	1.50"	.750"	.040"	100'	25	125'	
4012	2"	2.00"	1.00"	.045"	100'	25	125'	
4013	3"	3.00"	1.50"	.050"	100'	25	100'	
4014	4"	4.00"	2.00"	.055"	100'	25	100'	

## Heat Shrink Retail Packs

Part #	Dia	Color	Cut	Pcs
4000H	3/64"	Black	4"	8
4001H	1/16"	Black	4"	8
4002H	3/32"	Black	4"	7
4003H	1/8"	Black	4"	7
4004H	3/16"	Black	4"	7
4005H	1/4"	Black	4"	6
4006H	3/8"	Black	4"	6
4007H	1/2"	Black	4"	5

Part #	Dia	Color	Cut	Pcs
4008H	3/4"	Black	4"	3
4009H	1"	Black	4"	2
4051H	1/4" 3/8" 3/16"	Black	4"	8
4052H	1/2" 3/4" 1"	Black	4"	5
4053H	1/16" 3/32" 1/8" 3/16" 1/4"	Black	4"	7

Part #	Dia	Color	Cut	Pcs
4054H	1/16"	Rainbow	4"	10
4055H	3/32"	Rainbow	4"	10
4056H	1/8"	Rainbow	4"	10
4057H	3/16"	Rainbow	4"	10
4058H	1/4"	Rainbow	4"	5
4059H	3/8"	Rainbow	4"	5
4060H	1/2"	Rainbow	4"	5



**Ordering is easy!**  
**Electronic Data Interchange**  
**Phone, Fax, Email**

## Heat Shrinkable Tubing: 4' Stick w/Pre-priced Header

- Irradiated polyolefin tubing for general use applications.
- Lengths of shrinkable tubing are pre-priced and identified with part number, expanded and recovered size.
- Material Provides Excellent Electrical and Mechanical Protection

Operating Temperature Range: -67°F to 275°F  
 Shrink Ratio: 2 to 1  
 Shrink Temperature: 250°F

Size	Black	Clear	Red	Yellow	Blue	White	Green	Expanded I.D.	Recovered I.D.
1/16"	J-8501	J-8511	J-8521	J-8531	J-8541	J-8551	J-8581	.063"	.031"
3/32"	J-8502	J-8512	J-8522	J-8532	J-8542	J-8552	J-8582	.093"	.046"
1/8"	J-8503	J-8513	J-8523	J-8533	J-8543	J-8553	J-8583	.125"	.062"
3/16"	J-8504	J-8514	J-8524	J-8534	J-8544	J-8554	J-8584	.187"	.093"
1/4"	J-8505	J-8515	J-8525	J-8535	J-8545	J-8555	J-8585	.250"	.125"
3/8"	J-8506	J-8516	J-8526	J-8536	J-8546	J-8556	J-8586	.375"	.187"
1/2"	J-8507	J-8517	J-8527	J-8537	J-8547	J-8557	J-8587	.500"	.250"
3/4"	J-8508	J-8518	J-8528	J-8538	J-8548	J-8558	J-8588	.750"	.375"
1"	J-8509	J-8519	J-8529	J-8539	J-8549	J-8559	J-8589	1.000"	.045"
1 1/2"	J-8510	J-8520	J-8530	J-8540	J-8550	J-8560	J-8590	1.500"	.750"

## Heat Shrinkable Tubing: Mini Spools



- Retail-sized quantities of general purpose, heat-shrinkable tubing.
- Spooled, irradiated polyolefin material is wrapped in plastic and identified with expanded and recovered size, part number, and feet per spool.

Size	Qty	Black	Clear	Red	Yellow	Blue	White	Green	Expanded I.D.	Recovered I.D.
1/16"	70'	J-8801	J-8811	J-8821	J-8831	J-8841	J-8851	J-8881	.063"	.031"
3/32"	65'	J-8802	J-8812	J-8822	J-8832	J-8842	J-8852	J-8882	.093"	.046"
1/8"	60'	J-8803	J-8813	J-8823	J-8833	J-8843	J-8853	J-8883	.125"	.062"
3/16"	50'	J-8804	J-8814	J-8824	J-8834	J-8844	J-8854	J-8884	.187"	.093"
1/4"	40'	J-8805	J-8815	J-8825	J-8835	J-8845	J-8855	J-8885	.250"	.125"
3/8"	35'	J-8806	J-8816	J-8826	J-8836	J-8846	J-8856	J-8886	.375"	.187"
1/2"	32'	J-8807	J-8817	J-8827	J-8837	J-8847	J-8857	J-8887	.500"	.250"
3/4"	24'	J-8808	J-8818	J-8828	J-8838	J-8848	J-8858	J-8888	.750"	.375"
1"	16'	J-8809	J-8819	J-8829	J-8839	J-8849	J-8859	J-8889	1.000"	.045"

wiring accessories master catalog rev704

## Heat Shrinkable Tubing 1/2" Cut & Marked Pieces - Black

Part#	Pcs	Description	Expanded I.D.	Recovered I.D.
J-1001	50	1/8" I.D. #0	.125"	.062"
J-1002	50	1/8" I.D. #1	.125"	.062"
J-1003	50	1/8" I.D. #2	.125"	.062"
J-1004	50	1/8" I.D. #3	.125"	.062"
J-1005	50	1/8" I.D. #4	.125"	.062"
J-1006	50	1/8" I.D. #5	.125"	.062"
J-1007	50	1/8" I.D. #6	.125"	.062"
J-1008	50	1/8" I.D. #7	.125"	.062"
J-1009	50	1/8" I.D. #8	.125"	.062"
J-1010	50	1/8" I.D. #9	.125"	.062"
J-1011	50	3/16" I.D. #0	.187"	.093"
J-1012	50	3/16" I.D. #1	.187"	.093"
J-1013	50	3/16" I.D. #2	.187"	.093"
J-1014	50	3/16" I.D. #3	.187"	.093"
J-1015	50	3/16" I.D. #4	.187"	.093"
J-1016	50	3/16" I.D. #5	.187"	.093"
J-1017	50	3/16" I.D. #6	.187"	.093"
J-1018	50	3/16" I.D. #7	.187"	.093"
J-1019	50	3/16" I.D. #8	.187"	.093"
J-1020	50	3/16" I.D. #9	.187"	.093"
J-1041	50	1/8" I.D. #0 - #9 Assort.	.125"	.062"
J-1042	50	3/16" I.D. #0 - #9 Assort.	.187"	.093"
J-1043	40	1/4" I.D. #0 - #9 Assort.	.250"	.125"
J-1044	40	3/8" I.D. #0 - #9 Assort.	.375"	.187"

## Adhesive Lined Heat Shrinkable Tubing

Seals & protects simple in-line splices, bi-metalic joints, and components from fluids, moisture and corrosion. Allows repair of damaged wire insulation. Provides one-stop electrical insulation and moisture sealing. Good mechanical strength and cut-through resistance.

Applicable Specifications:	MIL-I-23053/4 Class 2
Operating	-55°C to 110°C
Temperature Range:	-67°F to 230°F
Shrink Ratio:	2 to 1
Shrink Temperature:	121°C/249°F
Colors:	Black

### 4' Stick with Pre-Priced Header

Part#	Bulk Qty	Size	Expanded I.D.	Recovered I.D.	Nominal Wall Thickness
J-8710	100'	1/8"	.125"	.062"	.021"
J-8711	100'	3/16"	.187"	.093"	.022"
J-8712	100'	1/4"	.250"	.125"	.030"
J-8713	100'	3/8"	.375"	.187"	.031"
J-8714	100'	1/2"	.500"	.250"	.032"
J-8715	100'	3/4"	.750"	.375"	.037"
J-8716	100'	1"	1.000"	.500"	.038"
J-8717	40'	1 1/2"	1.500"	.750"	.039"

## Heat Shrinkable Tubing Assorted Color Markers: 1/2" Cut

Part#	Pcs	Description	Expanded I.D.	Recovered I.D.
J-1045	50	1/8" I.D. Assort. Colors	.125"	.062"
J-1046	50	3/16" I.D. Assort. Colors	.187"	.093"
J-1047	40	1/4" I.D. Assort. Colors	.250"	.125"
J-1048	40	3/8" I.D. Assort. Colors	.375"	.187"

## Heat Shrink Heat Gun



### Part # Description

<b>4222F</b>	- Dual Heat Settings (600°F to 1000°F) - 4 Amp or 10Am400 Watt
--------------	---

## Heavy Wall Adhesive - Lined Heat Shrinkable Tubing

Heavy duty polyolefin seals and blocks corrosive moisture for excellent cable insulation & protection

Applicable Specifications:	MIL-I-23053/4,AMS 3634
Operating	-55°C to 110°C
Temperature Range:	-67°F to 230°F
Shrink Ratio:	3 to 1
Shrink Temperature:	275°F
Colors:	Black & Red

## Cut Pieces

Part#	Qty	Length	Expanded I.D.	Recovered I.D.	Color	Fits AWG
4030	1	10.0"	.400"	.150"	Red	12-6
4030F	2	6.0"	.400"	.150"	Red	12-6
4030J	5	1.5"	.400"	.150"	Red	12-6
4031	1	10.0"	.400"	.150"	Black	12-6
4031F	2	6.0"	.400"	.150"	Black	12-6
4031J	5	1.5"	.400"	.150"	Black	12-6
4032	1	12.0"	.750"	.220"	Red	6-1
4032F	2	6.0"	.750"	.220"	Red	6-1
4032J	5	1.5"	.750"	.220"	Red	6-1
4033	1	12"	.750"	.220"	Black	6-1
4033F	2	6.0"	.750"	.220"	Black	6-1
4033J	5	1.5"	.750"	.220"	Black	6-1
4034	1	12"	1.100"	.375"	Red	4-4/0
4034F	2	6.0"	1.100"	.375"	Red	4-4/0
4034J	5	1.5"	1.100"	.375"	Red	4-4/0
4035	1	12"	1.100"	.375"	Black	4-4/0
4035F	2	6.0"	1.100"	.375"	Black	4-4/0
4035J	5	1.5"	1.100"	.375"	Black	4-4/0



**Ordering is easy!**  
Electronic Data Interchange  
Phone, Fax, Email

## Expandable Sleeving

### Flame Retardant Black

(Hot Knife Required) Bulk Quantities

Part #	Size	Qty.	Min Dia.	Max Dia
4101-0	1/8"	1000'	3/32"	1/4"
4102-0	1/4"	1000'	1/8"	7/16"
4103-0	1/2"	500'	1/4"	3/4"
4104-0	3/4"	250'	1/2"	1 1/4"
4105-0	1 1/4"	250'	3/4"	1 3/4"
4106-0	1 3/4"	200'	1 1/4"	2 3/4"
4107-0	2"	200'	1 1/2"	3 1/2"

### Clean-Cut PET Black

(No Hot Knife Necessary) Bulk Quantities

Part #	Size	Qty.	Min Dia.	Max Dia
4108-0	1/8"	1000'	1/8"	1/4"
4109-0	1/4"	1000'	5/32"	7/16"
4110-0	1/2"	500'	1/4"	3/4"
4111-0	3/4"	250'	5/8"	1"
4125-0	1"	250'	3/4"	1 3/16"
4112-0	1 1/4"	250'	1"	1 1/2"

### Mini-Spools: Clean-Cut PET Black

(No Hot Knife Necessary)

Part #	Size	Qty.	Min Dia.	Max Dia
4230-100-0	1/8"	100'	1/8"	1/4"
4231-100-0	1/4"	100'	5/32"	7/16"
4232-100-0	3/8"	100'	3/16"	5/8"
4233-100-0	1/2"	100'	1/4"	3/4"
4234-75-0	3/4"	75'	5/8"	1 1/4"
4235-50-0	1"	50'	1"	1 1/2"
4236-50-0	1 1/4"	50'	3/4"	1 3/16"
4237-50-0	1 1/2"	50'	1 1/4"	2"

### Mini-Spools: PET Grade Black

(Hot Knife Required)

Part #	Size	Qty.	Min Dia.	Max Dia
4200-225-0	1/8"	225'	3/32"	1/4"
4201-200-0	1/4"	200'	1/8"	7/16"
4202-125-0	3/8"	125'	3/16"	5/8"
4203-100-0	1/2"	100'	1/4"	3/4"
4204-100-0	5/8"	100'	3/8"	1"
4205-75-0	3/4"	75'	1/2"	1 1/4"
4206-50-0	1 1/4"	50'	3/4"	1 3/4"
4207-40-0	1 1/2"	40'	1"	2 1/2"
4208-30-0	1 3/4"	30'	1 1/4"	2 3/4"
4209-50-0	2"	50'	1 1/2"	3 1/2"
4210-50-0	2 1/2"	50'	1 3/4"	4 1/2"
4211-50-0	3"	50'	2 1/2"	4 3/4"

### Mini-Spools: Flame-Retardant Black (Hot Knife Required)

Part #	Size	Qty.	Min Dia.	Max Dia
4215-225-0	1/8"	225'	3/32"	1/4"
4216-200-0	1/4"	200'	1/8"	7/16"
4217-125-0	3/8"	125'	3/16"	5/8"
4218-100-0	1/2"	100'	1/4"	3/4"
4220-75-0	3/4"	75'	1/2"	1 1/4"
4221-50-0	1 1/4"	50'	3/4"	1 3/4"
4222-30-0	1 3/4"	30'	1 1/4"	2 3/4"
4223-50-0	2"	50'	1 1/2"	3 1/2"
4225-50-0	2 1/2"	50'	1 3/4"	4 1/2"

### Flexo-Wrap Spools

Part #	Size	Qty.	Color	Nominal Dia.	Hook Loop Width
4250-12-0	1 1/4"	12'	Black	1 1/4"	5/8"
4250-12-10	1 1/4"	12'	Beige	1 1/4"	5/8"
4250-12-8	1 1/4"	12'	Gray	1 1/4"	5/8"

### Flexo-Wrap Retail Packs

Part #	Size	Qty.	Color	Nominal Dia.	Hook Loop Width
514115-0-8	1 1/4"	3'	Black	1 1/4"	5/8"
514115-1-8	1 1/4"	3'	Beige	1 1/4"	5/8"
514115-8-8	1 1/4"	3'	Gray	1 1/4"	5/8"

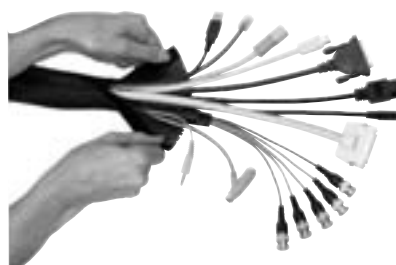

## Colored Flex-Guard Convuluted Tubing (Split Loom)

Part #	Pkg Qty	Description	Color
5304-2F	14'	1/4" Split Loom	Red
5304-4F	14'	1/4" Split Loom	Yellow
5304-6F	14'	1/4" Split Loom	Blue
5305-2F	10'	3/8" Split Loom	Red
5305-4F	10'	3/8" Split Loom	Yellow
5305-6F	10'	3/8" Split Loom	Blue
5306-2F	7'	1/2" Split Loom	Red
5306-4F	7'	1/2" Split Loom	Yellow
5306-6F	7'	1/2" Split Loom	Blue
5307-2F	5'	3/4" Split Loom	Red
5307-4F	5'	3/4" Split Loom	Yellow
5307-6F	5'	3/4" Split Loom	Blue

## Flex-Guard Convulved Tubing (Split Loom)

Split loom is designed to provide a flexible, crush-resistant protection for wiring assemblies. The convoluted surface enhances the appearance of your product by providing a uniform tailored finish. Split loom surpasses most tapes, looms, and braids. The split seam feature of split loom allows the wires to be inserted easily, eliminating the costly time needed to apply tape, braid or loom. Since the seam is not permanently sealed, the costs of repair or service are also reduced.

Part #	Pkg Qty	Description	Color
4304-3F	3'	1/4" Split loom	Black
4304-6F	6'	1/4" Split loom	Black
4304-9C	100'	1/4" Split loom	White
4304-9F	14'	1/4" Split loom	White
4304C	100'	1/4" Split loom	Black
4304F	14'	1/4" Split loom	Black
4305-9C	100'	3/8" Split loom	White
4305-9F	10'	3/8" Split loom	White
4305C	100'	3/8" Split loom	Black
4305F	10'	3/8" Split loom	Black
4306-9C	100'	1/2" Split loom	White
4306-9F	7'	1/2" Split loom	White
4306C	100'	1/2" Split loom	Black
4306F	7'	1/2" Split loom	Black
4307-9C	100'	3/4" Split loom	White
4307-9F	5'	3/4" Split loom	White
4307C	100'	3/4" Split loom	Black
4307F	5'	3/4" Split loom	Black
4308-9C	100'	1" Split loom	White
4308-9F	3'	1" Split loom	White
4308C	100'	1" Split loom	Black
4308F	3'	1" Split loom	Black
4309C	100'	1 1/4" Split loom	Black
4310-150	150'	1 1/2" Split loom	Black
4312C	100'	5/8" Split loom	Black

## Asphalt-Coated Fabric Loom

Asphalt-Coated Fabric Loom used for conduit in truck and trailer wire applications. Also used for making loom-covered battery cables. Heat resistant for under the hood use.

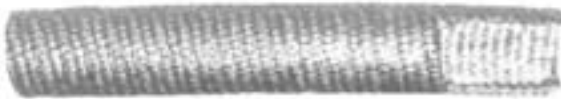

Bulk Part#	Nominal O.D.	Length	Retail Pack # 10' Lengths
4270	3/16"	50 Ft	4270F
4271	1/4"	50 Ft	4271F
4272	3/8"	50 Ft	4272F
4273	1/2"	50 Ft	4273F
4274	5/8"	50 Ft	--
4275	3/4"	25 Ft	--

## Spiral-Cut Tubing

Spiral-Cut Polyethylene Tubing is used to hold bundles of wires together. It is also used to wrap tubing and control rods for protection from abrasion and for noise suppression. Spiral cut tubing has an elastic memory and tends to come back to and hold its original shape. It can be re-used many times.

Standard Color: Natural.

Add "-0" to part # number for Black.

Example: 4200C-0 = 1/8" Black

Part#	Nom O.D.	Nom Wall	Nom Pitch	Max Bundle	Length
4200C	.125 (1/8")	.032	3/16"	1/2"	100'
4201C	.187 (3/16")	.030	1/4"	1 1/2"	100'
4203C	.250 (1/4")	.045	3/8"	2"	100'
4204C	.375 (3/8")	.052	7/16"	3"	100'
4205C	.500 (1/2")	.062	9/16"	4"	100'
4206C	.750 (3/4")	.065	3/4"	5"	100'
4207C	1.00 (1")	.080	1.00"	7"	100'

Part#	Description	Length
4250F	Combo 1/8" & 1/4"	10' x 2
4251F	Combo 3/8" & 1/2"	10' x 2

## Vinyl Grommets

A=Bore Diameter  
E=Groove Diameter  
(size of mounting hole)

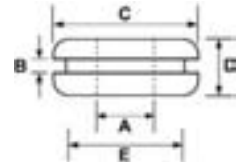

Part #	A	B	C	D	E	Qty
4400C	1/8"	1/16"	11/32"	3/16"	1/4"	100 Pcs
4400H	1/8"	1/16"	11/32"	3/16"	1/4"	18 Pcs
4401C	3/16"	1/16"	7/16"	7/32"	5/16"	100 Pcs
4401H	3/16"	1/16"	7/16"	7/32"	5/16"	15 Pcs
4402C	1/4"	1/16"	9/16"	1/4"	3/8"	100 Pcs
4402H	1/4"	1/16"	9/16"	1/4"	3/8"	13 Pcs
4403C	5/16"	1/16"	5/8"	1/4"	7/16"	100 Pcs
4403H	5/16"	1/16"	5/8"	1/4"	7/16"	12 Pcs
4404C	3/8"	1/16"	5/8"	1/4"	1/2"	100 Pcs
4404H	3/8"	1/16"	5/8"	1/4"	1/2"	11 Pcs
4405C	1/2"	1/16"	13/16"	9/32"	5/8"	100 Pcs
4405H	1/2"	1/16"	13/16"	9/32"	5/8"	7 Pcs
4406C	25/64"	1/8"	27/32"	3/8"	21/32"	100 Pcs
4406H	25/64"	1/8"	27/32"	3/8"	21/32"	5 Pcs
4407C	5/8"	1/16"	1 1/8"	9/32"	7/8"	100 Pcs
4407H	5/8"	1/16"	1 1/8"	9/32"	7/8"	4 Pcs
4408C	11/16"	1/16"	1 5/16"	3/8"	1"	100 Pcs
4408H	11/16"	1/16"	1 5/16"	3/8"	1"	4 Pcs
4409C	1"	1/8"	1 3/4"	1/2"	1 3/8"	100 Pcs
4409H	1"	1/8"	1 3/4"	1/2"	1 3/8"	2 Pcs

Part#	Sized by Mounting Hole	Qty
4450H	1/4" 5/16" 3/8"	13 Pcs
4451H	7/16" 1/2" 5/8"	9 Pcs
4452H	21/32" 7/8" 1" 1 3/8"	4 Pcs
4453H	1/4" thru 7/8"	9 Pcs



**Ordering is easy!**  
Electronic Data Interchange  
Phone, Fax, Email

**62-5021 Standard Duty**  
Cable Tie Tool 18 - 40 lb ties



**62-5022 Medium Duty**  
Cable Tie Tool 18-120 lb ties



**Cable Ties (18-50 lb Tensile Strength)**

Length	Qty.	Natural	Black	Red	Purple	Green	Blue	Yellow	Grey	Tensile Strength
4.0"	31	4701H	4702H	4701-2H	4701-4H	4701-5H	4701-6H	4701-7H	4701-8H	18 lbs.
4.0"	100	4701C	4702C	4701-2C	4701-4C	4701-5C	4701-6C	4701-7C	4701-8C	18 lbs.
4.0"	1,000	4701M	4702M	4701-2M	4701-4M	4701-5M	4701-6M	4701-7M	4701-8M	18 lbs.
5.5"	25	4703H	4704H	4703-2H	4703-4H	4703-5H	4703-6H	4703-7H	4703-8H	40 lbs.
5.5"	100	4703C	4704C	4703-2C	4703-4C	4703-5C	4703-6C	4703-7C	4703-8C	40 lbs.
5.5"	1,000	4703M	4704M	4703-2M	4703-4M	4703-5M	4703-6M	4703-7M	4703-8M	40 lbs.
7.5"	14	4705H	4706H	4705-2H	4705-4H	4705-5H	4705-6H	4705-7H	4705-8H	50 lbs.
7.5"	100	4705C	4706C	4705-2C	4705-4C	4705-5C	4705-6C	4705-7C	4705-8C	50 lbs.
7.5"	1,000	4705M	4706M	4705-2M	4705-4M	4705-5M	4705-6M	4705-7M	4705-8M	50 lbs.
11.5"	14	4707H	4708H	4707-2H	4707-4H	4707-5H	4707-6H	4707-7H	4707-8H	50 lbs.
11.5"	100	4707C	4708C	4707-2C	4707-4C	4707-5C	4707-6C	4707-7C	4707-8C	50 lbs.
11.5"	500	4707D	4708D	--	--	--	--	--	--	50 lbs.
14.5"	8	4709H	4710H	--	--	--	--	--	--	50 lbs.
14.5"	100	4709C	4710C	4709-2C	4709-4C	4709-5C	4709-6C	4709-7C	4709-8C	50 lbs.
14.5"	500	4709D	4710D	--	--	--	--	--	--	50 lbs.

**Neon Colored Ties (18 - 50 lb Tensile Strength)**

Length	Qty.	Neon Green	Neon Pink	Neon Yellow	Neon Orange	Tensile Strength
4.0"	35	4701N5H	4701N8H	4701N7H	4701N3H	18 lbs.
4.0"	100	4701N5C	4701N8C	4701N7C	4701N3C	18 lbs.
4.0"	1000	4701N5M	4701N8M	4701N7M	4701N3M	18 lbs.
5.5"	25	4703N5H	4703N8H	4703N7H	4703N3H	40 lbs.
7.5"	100	4705N5C	4705N8C	4705N7C	4705N3C	50 lbs.
7.5"	1000	4705N5M	4705N8M	4705N7M	4705N3M	50 lbs.
11.5"	10	4707N5H	4707N8H	4707N7H	4707N3H	50 lbs.

**Screw-Mount Cable Ties (50-120 lb Tensile Strength)**

Length	Qty.	Natural	Black	Tensile Strength
7.5"	13	4724H	--	50 lbs
7.5"	13	--	4725H	50 lbs
7.5"	100	4724C	4725C	50 lbs.
7.5"	500	4724D	4725D	50 lbs.
12.5"	6	4726H	--	50 lbs
12.5"	6	--	4727H	50 lbs
12.5"	50	4726F	4727F	50 lbs.
12.5"	100	4726C	4727C	50 lbs.
12.5"	500	4726D	4727D	50 lbs.
14.5"	6	4728H	--	50 lbs.
14.5"	50	4728F	--	50 lbs.
14.5"	100	4728C	--	50 lbs.
14.5"	3	4730H	--	120 lbs.
14.5"	100	4730C	--	120 lbs.

**Adhesive Wire Tie Mounts for 18 & 40 lb ties**

Qty	Part #	Color
50	274732-1	Black
100	274732-2	Black
1,000	274732-4	Black
10	4734H	Natural
50	274734-8	Natural
100	4734C	Natural

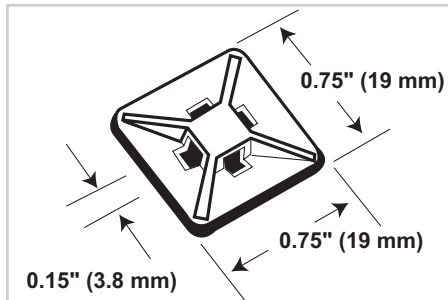

**Adhesive Wire Tie Mounts for 50 lb ties - #8 Screw**

Qty	Part #	Color
50	274733-1	Black
100	274733-2	Black
1,000	274733-4	Black
10	4735H	Natural
50	274735-1	Natural
100	4735C	Natural
1,000	274735-4	Natural

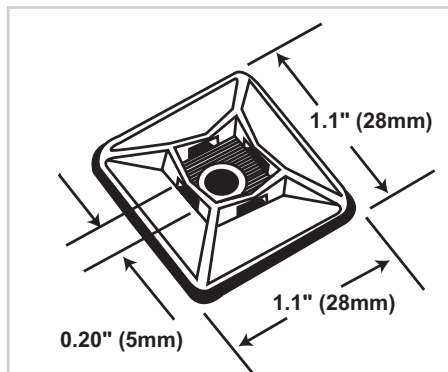

**Heavy Duty Cable Ties (120 - 175 lb Tensile Strength)**

Length	Qty.	Natural	Black	Tensile Strength
7.5"	100	204713-2	204714-2	120 lbs.
14.5"	5	4711H	4712H	120 lbs.
14.5"	50	204711-1	204712-1	120 lbs.
14.5"	100	204711-2	204712-2	120 lbs.
14.5"	500	204711-3	204712-3	120 lbs.
17"	50	214710-1	214711-1	175 lbs.
24"	50	214712-1	214713-1	175 lbs.
28"	4	4714F	--	175 lbs
28"	50	214714-1	214715-1	175 lbs.
32"	50	214716-1	214717-1	175 lbs.
32"	4	4716F	--	175 lbs
40"	50	214718-1	214719-1	175 lbs.
48"	50	214720-1	214721-1	175 lbs.

wiring accessories master catalog rev704



## 62-5023

Heavy-Duty Cable Tie Tool  
18-175 lb ties



### Kits and Assortments

Qty.	Part #	Description
650	4790F	Color/Natural/Black Assortment
500	4791F	Natural/Black Assortment
650	4792F	Natural Assortment
100	4798F	4" Black/Natural Assortment
100	4799F	4" Color Assortment
15	4750H	4" & 7.5" Natural Assortment
6	4751H	11.5" & 14.5" Natural Assortment
14	4752H	4" thru 14.5" Natural Assortment
30	4753H	Natural Tie and Mount Assortment
14	4754H	Clamps, Grommets & Tie Assort

### Strip-Ties

Hook & Loop w/Buckle



Part #	Pkg Qt	Length	Color
20-6-0	10	6"	Black
20-6-2	10	6"	Red
20-6-6	10	6"	Blue
20-6-9	10	6"	White
20-6-13	10	6"	Neon Yellow
20-8-0	8	8"	Black
20-8-2	8	8"	Red
20-8-6	8	8"	Blue
20-8-9	8	8"	White
20-8-13	8	8"	Neon Yellow
20-12-0	6	12"	Black
20-12-2	6	12"	Red
20-12-6	6	12"	Blue
20-12-9	6	12"	White
20-12-13	6	12"	Neon Yellow

Hook & Loop w/slit



21-6-0	10	6"	Black
21-8-0	8	8"	Black

### Specialty Ties

Push Mount (Natural)

Length	Qty.	Part #	Tensile Strength
5"	100	244703-2	50 lbs.
7.5"	100	244705-2	50 lbs.

Plenum-Rated Ties (Halar)

8"	100	264705-2	50 lbs.
8"	10	264705-8	50 lbs.

Stainless-Steel Ties

5.5"	50	304703-1	100 lbs.
5.5"	10	304703-1F	100 lbs.
7.5"	50	304705-1	250 lbs.
7.5"	10	304705-1F	250 lbs.
14.5"	50	304709-1	250 lbs.
14.5"	50	304709-1F	250lbs



### Nylon Cable Clamps

Part #	Product Description	Qty
4600C	Nylon Cable Clamps 1/8" Natural	100
4600H	Nylon Cable Clamps 1/8" Natural	30
4600H-0	Nylon Cable Clamps 1/8" Black	30
4601C	Nylon Cable Clamps 3/16" Natural	100
4601H	Nylon Cable Clamps 3/16" Natural	29
4601H-0	Nylon Cable Clamps 3/16" Black	29
4602C	Nylon Cable Clamps 1/4" Natural	100
4602H	Nylon Cable Clamps 1/4" Natural	25
4602H-0	Nylon Cable Clamps 1/4" Black	25
4603C	Nylon Cable Clamps 5/16" Natural	100
4603H	Nylon Cable Clamps 5/16" Natural	25
4603H-0	Nylon Cable Clamps 5/16" Black	25
4604C	Nylon Cable Clamps 3/8" Natural	100
4604H	Nylon Cable Clamps 3/8" Natural	22
4604H-0	Nylon Cable Clamps 3/8" Black	22
4605C	Nylon Cable Clamps 7/16" Natural	100
4605H	Nylon Cable Clamps 7/16" Natural	15
4605H-0	Nylon Cable Clamps 7/16" Black	15
4606C	Nylon Cable Clamps 1/2" Natural	100
4606H	Nylon Cable Clamps 1/2" Natural	15
4606H-0	Nylon Cable Clamps 1/2" Black	15
4607C	Nylon Cable Clamps 9/16" Natural	100
4607H	Nylon Cable Clamps 9/16" Natural	14
4607H-0	Nylon Cable Clamps 9/16" Black	14
4608C	Nylon Cable Clamps 5/8" Natural	100
4608H	Nylon Cable Clamps 5/8" Natural	10
4608H-0	Nylon Cable Clamps 5/8" Black	10
4609C	Nylon Cable Clamps 11/16" Natural	100
4609H	Nylon Cable Clamps 11/16" Natural	10
4609H-0	Nylon Cable Clamps 11/16" Black	10
4610C	Nylon Cable Clamps 3/4" Natural	100
4610H	Nylon Cable Clamps 3/4" Natural	8
4610H-0	Nylon Cable Clamps 3/4" Black	8
4611C	Nylon Cable Clamps 7/8" Natural	100
4611H	Nylon Cable Clamps 7/8" Natural	7
4611H-0	Nylon Cable Clamps 7/8" Black	7
4612C	Nylon Cable Clamps 1" Natural	100
4612H	Nylon Cable Clamps 1" Natural	6
4612H-0	Nylon Cable Clamps 1" Black	6
4613C	Nylon Cable Clamps 1 1/8" Natural	100
4613H	Nylon Cable Clamps 1 1/8" Natural	5
4613H-0	Nylon Cable Clamps 1 1/8" Black	5
4650H	Assortment [1/8", 1/4", 3/16"]	18
4651H	Assortment [5/16", 3/8", 7/16"]	15
4652H	Assortment [1/2", 5/8", 9/16"]	10
4653H	Assortment [3/4" & 1"]	15

### 4755F Radiator Mounting Straps

Adjustable Locking Nylon Straps System

- Two piece all nylon design.
- 8" Lengths, fully adjustable.
- U.S. Patent 4617702

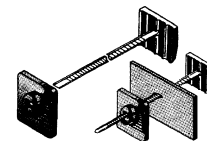



**Ordering is easy!**  
Electronic Data Interchange  
Phone, Fax, Email

### 2" Test Clips and Leads



Part #	Description	Pcs
215-1F	Black Handle	25
215-2F	Red Handle	25
215H	Red / Black Combo	2 sets

### Mini Test Clips



Part #	Description	Pcs
217F	1" Test Clip	25
217H	1" Test Clip	8
217-1F	1" Clip Black Boot	25
217-2F	1" Clip Red Boot	25
220H	1" Clip Combo Pack	2 sets



Part #	Description	Pcs
219F	Test Leads 30" (1) Red Wire, (1) Black Wire	2



Part #	Description	Pcs
218F	2" Test Clip Standard	25
218H	2" Test Clip Standard	6
218-1F	2" Clips w/ Black Boot	25
218-2F	2" Clips w/ Red Boot	25
221H	Mini 2" Test Clips, Red/Black Combo	1 set

### Nickel Plated Charging Clips



Part #	Description	Pcs
240H	5 Amp	4
241H	10 Amp	4
242	20 Amp	10
242H	20 Amp	2
245	50 Amp	10



Part #	Description	Pcs
226F	Heavy duty test leads 36" length. features silicone rubber leads w/10 amp charging clips	2

### Insulated Clamps



Part #	Description	Pcs
253F	30 Amp, Red/Black	1 set
253-1F	30 Amp, Black	10
253-2F	30 Amp, Red	10
254F	50 Amp, Black, Red	1 set
254-1F	50 Amp, Black	10
254-2F	50 Amp Red	10



Part #	Description	Pcs
225F	Deluxe test leads, 33" length. features vinyl leads w/10 amp charging clips	2

### Santoprene Insulated Clamps

Cold rolled steel  
1/4" mounting hole



**Santoprene** is a superior material in areas of friction, grip effort, surface texture, perceived control, finger comfort and hand comfort in comparison with grips made of steel or polypropylene. Other attributes include soft-touch, durability, resistance to heat and various fluids.

Part #	Product Description	Qty
4464	Santoprene Clamps 1/4"	25
4464F	Santoprene Clamps 1/4"	10
4466	Santoprene Clamps 3/8"	25
4466F	Santoprene Clamps 3/8"	10
4468	Santoprene Clamps 1/2"	25
4468F	Santoprene Clamps 1/2"	10
4470	Santoprene Clamps 5/8"	25
4470F	Santoprene Clamps 5/8"	10
4472	Santoprene Clamps 3/4"	25
4472F	Santoprene Clamps 3/4"	10
4474	Santoprene Clamps 7/8"	25
4474F	Santoprene Clamps 7/8"	10
4476	Santoprene Clamps 1"	25
4476F	Santoprene Clamps 1"	10
4478	Santoprene Clamps 1 1/4"	25
4478F	Santoprene Clamps 1 1/4"	10
4484	Santoprene Clamps 1 1/2"	25
4484F	Santoprene Clamps 1 1/2"	10
4490F	Santoprene Clamps, Assort. [1/4", 3/8", 1/2", 5/8", 3/4"]	10
4495F	Santoprene Clamps, Assort. [7/8", 1", 1 1/4" 1 1/2"]	10

## Hand Tools and Testers

### Weather-Pack Crimping Tool



**5000F**  
Designed for crimping open barrel 18, 16 & 14 AWG terminals. The 5000F performs a starter crimp on 20 and 12 gauge wire.

### Economy Crimping Tool



**5002F**  
Cuts wire and strips 22-10 AWG wire  
Crimps insulated terminals including 7mm ignition terminals Cuts/rethreads machine screws - Cushion grip handles.

### Deluxe Crimping Tool



**5003F**  
Cuts wire and strips 22-10 AWG wire  
Crimps insulated terminals including 7mm ignition terminals Cuts & re-threads machine screws - Also provides insulation crimp for extra "pull strength" Cushion grip handles.

### Easy Stripper



**5008F**  
Multi-Function, self-adjusting stripper with cutting and crimping actions. 9" length. Cuts wire and strips 26-10 AWG wire. Crimps insulated and non-insulated terminals - Cushion grip handles.

### Electrician's Wire Stripper



**5010F**  
Electrician "Spring Action" Wire Stripper  
Screw lock for setting wire size from 28-10 AWG · Slits Romex cable and other multi-conductor cable.

### Ratchet Crimper



**5011F**  
Precise professional crimp guaranteed each time on insulated terminals only. 22-10 AWG, 1.0" length · Release controlled ratchet mechanism ensures consistent quality crimps · Non-slip handles.

### Heavy Duty Easy Stripper



**5020F**  
Automatically adjusts to strip 10 to 24 AWG - or even smaller using a micro-adjust knob. Three different crimpers let you work with insulated terminals 10-22 AWG, non-insulated 10-22 AWG.

### Deluxe Circuit Tester

**230F**  
Durable 6-24V high quality professional tester for checking electrical circuits in automotive, marine, truck and trailer applications. Replaceable bulb (#230F BULB), sharp point to penetrate low-voltage wire. Insulated, strong clip for positive connection.



### 12V DC Circuit Tester

**232F**  
Durable 12V tester for checking electrical circuits in automotive, marine, truck and trailer applications. Replaceable bulb, sharp point to penetrate low-voltage wire. Insulated, strong clip for positive connection.



### Pocket Automotive Tester

**233F**  
Handy automotive ignition tester for checking automotive circuits. 12V test light and insulated clip.



### Low Voltage Tester

**234F**  
5-50V AC/DC tester with illuminated indicator. Insulated clips for positive connection.



### Battery Analyzer / Tester

**235F**  
Alternator and battery status indicator LED shows normal, low or flat level charge. Magnetic strip on back for easy attachment to car body.





**Vinyl Carburetor Vacuum Caps**  
Standard Black



Part #	Size I.D.	Pcs
4800C	1/8"	100
4800H	1/8"	3
4801C	3/16"	100
4802C	1/4"	100
4802H	1/4"	18
4803H	5/16"	15
4803C	5/16"	100
4804C	3/8"	100
4804H	3/8"	10
4805F	1/8" - 1/2"	35
4805H	1/8" - 3/8"	50
4806C	1/2"	100
4806H	1/2"	5



Color Assortment

Part #	Size I.D.	Pcs
4805F-1	1/8"-5/16"	35

**Hypalon Rubber Vacuum Caps**  
Standard Black



Part #	Size I.D.	Pcs
4810	1/8"	50
4810H	1/8"	3
4811	3/16"	50
4811H	3/16"	3
4812	1/4"	50
4812H	1/4"	3
4813	3/8"	50
4813H	3/8"	2

These round grips are manufactured to provide a secure fit on your product/ They are ideal for handles, covers, steel tubing and paint masks.

**Windshield Washer Fittings**

Tee Connector



Part #	Size I.D.	Pcs
4816	1/8"	50
4816H	1/8"	2
4817	3/16"	50
4817H	3/16"	2
4818	1/4"	50
4818H	1/4"	2
4819	3/8"	50
4819H	3/8"	2

"Y" Connector



Part #	Size I.D.	Pcs
4832	3/16"x3/16"x3/16"	50
4832H	3/16"x3/16"x3/16"	2
4833	1/4"x1/4"x1/4"	50
4833H	1/4"x1/4"x1/4"	2
4834	1/4"x1/4"x3/16"	50
4834H	1/4"x1/4"x3/16"	2
4836	1/4"x3/8"x3/8"	50
4836H	1/4"x3/8"x3/8"	2
4837	3/8"x3/8"x3/8"	50

4 Way Connector



Part #	Size O.D.	Pcs
4830H	3/16"	2

Connector



Part #	Size I.D.	Pcs
4822	1/8" x 1/8"	50
4822H	1/8" x 1/8"	2
4823	3/16" x 3/16"	50
4823H	3/16" x 3/16"	2
4824	1/4" x 1/4"	50
4824H	1/4" x 1/4"	2
4825	3/8" x 3/8"	50
4825H	3/8" x 3/8"	2
4826	1/8" x 1/4"	50
4826H	1/8" x 1/4"	2

5 Way Connector



Part #	Size O.D.	Pcs
4831	3/16"	50
4831H	3/16"	1

## Automotive Accessories



- 7900F Back-up Alarm**  
Warns those behind your car, truck, van or RV when you're backing up.
- Fits all vehicles
  - 100% solid state
  - SIMPLE two-wire connection
  - Audible pulse alarm



- Distribution Block**  
7785F (Rectangular - Gold)  
7786F (Triangular - Gold)
- Four outputs accept up to 8 AWG wire
  - One 4 AWG wire input
  - Perfect for stereo systems



- 7902F Mini Back-up Alarm**  
Warns those behind your vehicle when you're backing up.
- Perfect for larger autos, mini-vans, light trucks, and RVs.
  - Small size and mounting bracket design allow for many location options.
  - Everything needed for easy installation



- Power Tap™ Battery Bolts**  
7925F (Standard Mount)  
7926F (Long Side Mount)  
Perfect Way to Power-Up Equipment and Accessories to Side-Post Batteries -
- A MUST-HAVE for GM Vehicles!
  - Solves jumper cable grip problems/great for battery chargers.
  - SIMPLE under-the-hood 12-volt hook-up; replaces original bolt in minutes.
  - Made of solid brass; comes with matching 3/8" ring terminal and nut.
  - Designed & approved especially for General Motors and all other side-post battery vehicles.



- 7905F Headlights Left-on Alert**
- Fits all vehicles.
  - 100% solid state.
  - Electronic tone sounds if headlights are left on after ignition is off.
  - NO wiring! NO tools needed! Connects in second fuse clips (provided).
  - General Motors approved.



- Power Tap™ Fuse Clips**  
7930F (Round Glass Fuses)  
7931F (ATC/ATO Fuses)  
EASY 12-Volt Hook-Up for Stereos, CBs, and Other Accessories.
- Comes with TWO clips and TWO matching, fully insulated female disconnects.
  - Provides direct power connection at the fuse block.
  - Makes SOLID, SAFE, QUICK and EASY connections.
  - Patented and General Motors approved.



- 7910F Daytime Running Lights**
- Automatically turns low beams on/off with ignition.
  - Eliminates dead batteries from lights on when engine is off.
  - SIMPLE under-hood installation, NO wire-cutting, ALL hardware supplied.
  - Correct high/low beam action maintained, light switch action unaffected/ can be overridden.
  - Dust/moisture proof and fuse protected.
  - May be ordered with headlights-inhibit while starting feature.
  - (Special General Motors approved battery bolt [Part # 7925F] for easy accessory hook-up for GM vehicles with side-post batteries.



Ordering is easy!  
Electronic Data Interchange  
Phone, Fax, Email

**8900 Spinner Merchandiser**  
460 SKUs



JTT #	QTY.	DESCRIPTION
188F	30 Ft	18 AWG PRIMARY WIRE - BROWN
189F	30 Ft	18 AWG PRIMARY WIRE - WHITE
202F	3 Ft.	16 AWG FUSIBLE LINK WIRE
203F	3 Ft.	14 AWG FUSIBLE LINK WIRE
204F	2 Ft.	12 AWG FUSIBLE LINK WIRE
205F	1 Ft.	10 AWG FUSIBLE LINK WIRE
206H	1 Pc	18 AWG FUSIBLE LINK - 5/16" STUD
207F	1 Pc	16 AWG FUSIBLE LINK - 5/16" STUD
208F	1 Pc	14 AWG FUSIBLE LINK - 5/16" STUD
209F	1 Pc	16 AWG FUSIBLE LINK - 1/4" STUD
210F	1 Pc	14 AWG FUSIBLE LINK - 3/8" STUD
214F	1 Set	12 AWG FUSIBLE LINK - WITH TERMINALS
215H	2 Sets	TEST CLIP - 2" RED AND BLACK COMBO
219F	1 Set	TEST LEADS - RED AND BLACK WITH 30" WIRE
220H	2 Sets	MINI TEST CLIP - 1" COMBO PACK
221H	1 Set	MINI TEST CLIP - 2" RED AND BLACK COMBO
222F	25 Ft	SPEAKER WIRE - 2 WIRE
225F	1 Set	TEST LEADS - DELUXE - RED AND BLACK WITH 30" WIRE
233F	1 Pc	POCKET AUTOMOTIVE TESTER
235F	1 Pc	BATTERY ANALYZER/TESTER
253F	1 Set	INSULATED CLAMPS - 30 AMP - RED AND BLACK COMBO
254F	1 Set	INSULATED CLAMPS - 50 AMP - BLACK AND RED
10-0003	2 Pcs	SMART GLOW AGC FUSE - 3 AMP
10-0007	2 Pcs	SMART GLOW AGC FUSE - 7.5 AMP
10-1000	2 Pcs	SMART GLOW AGC FUSE - 5 AMP
10-1001	2 Pcs	SMART GLOW AGC FUSE - 10 AMP
10-1002	2 Pcs	SMART GLOW AGC FUSE - 15 AMP
10-1003	2 Pcs	SMART GLOW AGC FUSE - 20 AMP
10-1004	2 Pcs	SMART GLOW AGC FUSE - 25 AMP
10-1005	2 Pcs	SMART GLOW AGC FUSE - 30 AMP
11-0007	2 Pcs	SMART GLOW MINI FUSE - 7.5 AMP
11-1000	2 Pcs	SMART GLOW MINI FUSE - 5 AMP
11-1001	2 Pcs	SMART GLOW MINI FUSE - 10 AMP
11-1002	2 Pcs	SMART GLOW MINI FUSE - 15 AMP
11-1003	2 Pcs	SMART GLOW MINI FUSE - 20 AMP
11-1004	2 Pcs	SMART GLOW MINI FUSE - 25 AMP
11-1005	2 Pcs	SMART GLOW MINI FUSE - 30 AMP
11-1008	6 Pcs	SMART GLOW MINI FUSE - ASSORTMENT
1208H	10 Pcs	FUSE POWER TAP FOR ATC/ATO FUSE - .250 TAB
1212H	19 Pcs	FUSE POWER TAP FOR GLASS FUSE - .250 TAB
1216H	15 Pcs	22-14 AWG CLOSED END CONNECTOR - NYLON
1217H	10 Pcs	12-10 AWG CLOSED END CONNECTOR - NYLON
1220-1H	7 Pcs	18-14 AWG MID-LINE TAP - WHITE - NO-STOP
1220-2H	6 Pcs	22-16 AWG MID-LINE TAP - RED - W/ STOP
1220H	6 Pcs	18-14 AWG TAP SPLICE CONNECTOR - BLUE - W/ STOP
1222H	6 Pcs	18-12 AWG TWIST CONNECTOR - SOFT VINYL - YELLOW
1223H	6 Pcs	16-10 AWG TWIST CONNECTOR - SOFT VINYL - RED
1305F	5 Pcs	6 AWG SEAMLESS COPPER LUG - 3/8" STUD
1309F	5 Pcs	4 AWG SEAMLESS COPPER LUG - 3/8" STUD
1314F	5 Pcs	2 AWG SEAMLESS COPPER LUG - 3/8" STUD
2002H	19 Pcs	22-18 AWG VINYL INSULATED RING - #10
2003H	14 Pcs	22-18 AWG VINYL INSULATED RING - 1/4"
2006H	19 Pcs	16-14 AWG VINYL INSULATED RING - #8
2007H	19 Pcs	16-14 AWG VINYL INSULATED RING - #6
2008H	19 Pcs	16-14 AWG VINYL INSULATED RING - #10
2009H	14 Pcs	16-14 AWG VINYL INSULATED RING - 1/4"
2010H	14 Pcs	16-14 AWG VINYL INSULATED RING - 5/16"
2011H	14 Pcs	16-14 AWG VINYL INSULATED RING - 3/8"
2013H	14 Pcs	12-10 AWG VINYL INSULATED RING - #8
2014H	14 Pcs	12-10 AWG VINYL INSULATED RING - #10
2015H	12 Pcs	12-10 AWG VINYL INSULATED RING - 1/4"
2016H	12 Pcs	12-10 AWG VINYL INSULATED RING - 5/16"
2017H	12 Pcs	12-10 AWG VINYL INSULATED RING - 3/8"
2018H	7 Pcs	12-10 AWG VINYL INSULATED RING - 1/2"
2020H	4 Pcs	8 AWG HEAVY-DUTY VINYL INSULATED RING - 1/4"
2021H	4 Pcs	8 AWG HEAVY-DUTY VINYL INSULATED RING - 5/16"
2022H	4 Pcs	8 AWG HEAVY-DUTY VINYL INSULATED RING - 3/8"
20300F	2 Pcs	MINI FUSE - 2 AMP
20301F	2 Pcs	MINI FUSE - 3 AMP
20302F	2 Pcs	MINI FUSE - 4 AMP
20303F	2 Pcs	MINI FUSE - 5 AMP
20304F	2 Pcs	MINI FUSE - 7.5 AMP
20305F	2 Pcs	MINI FUSE - 10 AMP
20306F	2 Pcs	MINI FUSE - 15 AMP
20307F	2 Pcs	MINI FUSE - 20 AMP
20308F	2 Pcs	MINI FUSE - 25 AMP
20309F	2 Pcs	MINI FUSE - 30 AMP
20310F	1 Pc	MAXI FUSE - 20 AMP
20311F	1 Pc	MAXI FUSE - 30 AMP
20312F	1 Pc	MAXI FUSE - 40 AMP
20313F	1 Pc	MAXI FUSE - 50 AMP
20314F	1 Pc	MAXI FUSE - 60 AMP
20315F	1 Pc	MAXI FUSE - 80 AMP
20316F	1 Pc	PAL FEMALE FUSE - 30 AMP
20317F	1 Pc	PAL FEMALE FUSE - 40 AMP
20318F	1 Pc	PAL FEMALE FUSE - 60 AMP
20323F	1 Pc	PAL BENT MALE FUSE - 40 AMP
20325F	1 Pc	12 AWG FUSE HOLDER - HD WATERPROOF - 3-30 AMP ATC FUSE
20326F	1 Pc	PAL FEMALE FUSE - 20 AMP
2052H	19 Pcs	22-18 AWG VINYL INSULATED SPADE - #10
2054H	19 Pcs	16-14 AWG VINYL INSULATED SPADE - #8

JTT #	QTY.	DESCRIPTION
2055H	19 Pcs	16-14 AWG VINYL INSULATED SPADE - #10
2058H	14 Pcs	12-10 AWG VINYL INSULATED SPADE - #10
2060C	100 Pcs	22-18 AWG VINYL INSULATED BUTT CONNECTOR
2060H	20 Pcs	22-18 AWG VINYL INSULATED BUTT CONNECTOR
2061C	100 Pcs	16-14 AWG VINYL INSULATED BUTT CONNECTOR
2061H	20 Pcs	16-14 AWG VINYL INSULATED BUTT CONNECTOR
2062C	100 Pcs	12-10 AWG VINYL INSULATED BUTT CONNECTOR
2062F	50 Pcs	12-10 AWG VINYL INSULATED BUTT CONNECTOR
2062H	14 Pcs	12-10 AWG VINYL INSULATED BUTT CONNECTOR
2063H	2 Pcs	8 AWG HEAVY-DUTY VINYL INSULATED BUTT CONNECTOR
2065C	100 Pcs	22-18 AWG NYLON INSULATED BUTT CONNECTOR
2065H	14 Pcs	22-18 AWG NYLON INSULATED BUTT CONNECTOR
2066C	100 Pcs	16-14 AWG NYLON INSULATED BUTT CONNECTOR
2066H	14 Pcs	16-14 AWG NYLON INSULATED BUTT CONNECTOR
2067H	8 Pcs	12-10 AWG NYLON INSULATED BUTT CONNECTOR
20-8-0	8 Pcs	HOOK AND LOOP STRIP TIES - BLACK - 8"
20-8-13	8 Pcs	HOOK AND LOOP STRIP TIES - NEON YELLOW - 8"
20-8-2	8 Pcs	HOOK AND LOOP STRIP TIES - RED - 8"
20-8-6	8 Pcs	HOOK AND LOOP STRIP TIES - BLUE - 8"
20-8-9	8 Pcs	HOOK AND LOOP STRIP TIES - WHITE - 8"
2102C	100 Pcs	22-18 AWG VINYL INSULATED FEMALE DISCONNECT - .250"
2102H	19 Pcs	22-18 AWG VINYL INSULATED FEMALE DISCONNECT - .250"
2103H	19 Pcs	22-18 AWG VINYL INSULATED MALE DISCONNECT - .250"
2104H	19 Pcs	16-14 AWG VINYL INSULATED FEMALE DISCONNECT - .187"
2105C	100 Pcs	16-14 AWG VINYL INSULATED FEMALE DISCONNECT - .250"
2105H	20 Pcs	16-14 AWG VINYL INSULATED FEMALE DISCONNECT - .250"
2106H	19 Pcs	16-14 AWG VINYL INSULATED MALE DISCONNECT - .250"
2107F	50 Pcs	12-10 AWG VINYL INSULATED FEMALE DISCONNECT - .250"
2107H	15 Pcs	12-10 AWG VINYL INSULATED FEMALE DISCONNECT - .250"
2108H	15 Pcs	12-10 AWG VINYL INSULATED MALE DISCONNECT - .250"
2109H	9 Pcs	16-14 AWG VINYL INSULATED PIGGYBACK
2111H	20 Pcs	16-14 AWG VINYL INSULATED BULLET CONNECTOR - MALE - .157"
2112H	7 Pcs	16-14 AWG VINYL INSULATED BULLET CONNECTOR - FEMALE - .157"
2113H	7 Pcs	12-10 AWG VINYL INSULATED FEMALE DISCONNECT - .375"
2114C	100 Pcs	22-18 AWG NYLON FULLY INSULATED FEMALE DISCONNECT - .250"
2114H	10 Pcs	22-18 AWG NYLON FULLY INSULATED FEMALE DISCONNECT - .250"
2115H	10 Pcs	22-18 AWG NYLON FULLY INSULATED MALE DISCONNECT - .250"
2116C	100 Pcs	16-14 AWG NYLON FULLY INSULATED FEMALE DISCONNECT - .250"
2116H	10 Pcs	16-14 AWG NYLON FULLY INSULATED FEMALE DISCONNECT - .250"
2117H	10 Pcs	16-14 AWG NYLON FULLY INSULATED MALE DISCONNECT - .250"
2118H	7 Pcs	12-10 AWG NYLON FULLY INSULATED FEMALE DISCONNECT - .250"
2119H	7 Pcs	12-10 AWG NYLON FULLY INSULATED MALE DISCONNECT - .250"
2121H	5 Sets	16-14 AWG VINYL INSULATED DISCONNECT COMBO
2122H	4 Sets	16-14 AWG T-TAP WITH FULLY INSULATED DISCONNECT COMBO
2141H	6 Pcs	22-18 AWG VINYL INSULATED HOOK - #10
2142H	6 Pcs	16-14 AWG VINYL HOOK - #10
2143H	4 Pcs	12-10 AWG VINYL INSULATED HOOK - #10
2155H	18 Pcs	22-10 AWG MIXED DISCONNECT ASSORTMENT
2156H	17 Pcs	22-10 AWG VINYL INSULATED BUTT CONNECTOR COMBO
2158H	12 Pcs	22-12 AWG TWIST CONNECTOR ASSORTMENT
2161H	2 Pcs	22-18 AWG HEAT SHRINK HOOK - #10
2162H	2 Pcs	16-14 AWG HEAT SHRINK HOOK - #10
2163H	2 Pcs	12-10 AWG HEAT SHRINK HOOK - #10
2165H	4 Pcs	22-18 AWG VINYL INSULATED THREE-WAY CONNECTOR
2166H	4 Pcs	16-14 AWG VINYL INSULATED THREE-WAY CONNECTOR
2167H	3 Pcs	12-10 AWG VINYL INSULATED THREE-WAY CONNECTOR
2171H	2 Pcs	22-18 AWG VINYL INSULATED STEP-DOWN BUTT CONNECTOR
2175H	4 Pcs	22-18 AWG NYLON INSULATED THREE-WAY CONNECTOR
2176H	4 Pcs	16-14 AWG NYLON INSULATED THREE-WAY CONNECTOR
2177H	3 Pcs	12-10 AWG NYLON INSULATED THREE-WAY CONNECTOR
2181H	2 Pcs	16-14 AWG VINYL INSULATED STEP-DOWN BUTT CONNECTOR
2185H	2 Pcs	22-18 AWG HEAT SHRINK THREE-WAY CONNECTOR
2186H	2 Pcs	16-14 AWG HEAT SHRINK THREE-WAY CONNECTOR
2187H	2 Pcs	12-10 AWG HEAT SHRINK THREE-WAY CONNECTOR
2191H	2 Pcs	12-10 AWG VINYL INSULATED STEP-DOWN BUTT CONNECTOR
2265H	4 Pcs	22-18 AWG VINYL INSULATED FOUR-WAY CONNECTOR
2266H	4 Pcs	16-14 AWG VINYL INSULATED FOUR-WAY CONNECTOR
2267H	2 Pcs	12-10 AWG VINYL INSULATED FOUR-WAY CONNECTOR
2275H	4 Pcs	22-18 AWG NYLON INSULATED FOUR-WAY CONNECTOR
2276H	4 Pcs	16-14 AWG NYLON INSULATED FOUR-WAY CONNECTOR
2277H	2 Pcs	12-10 AWG NYLON INSULATED FOUR-WAY CONNECTOR
2285H	1 Pcs	22-18 AWG HEAT SHRINK FOUR-WAY CONNECTOR
2286H	1 Pcs	16-14 AWG HEAT SHRINK FOUR-WAY CONNECTOR
2287H	1 Pcs	12-10 AWG HEAT SHRINK FOUR-WAY CONNECTOR
2290H	14 Pcs	22-18 AWG VINYL INSULATED PIN TERMINAL
2291H	12 Pcs	16-14 AWG VINYL INSULATED PIN TERMINAL
2292H	8 Pcs	12-10 AWG VINYL INSULATED PIN TERMINAL
2293H	8 Pcs	22-18 AWG NYLON INSULATED FLAG DISCONNECT - .250"
2294H	8 Pcs	16-14 AWG NYLON INSULATED FLAG DISCONNECT - .250"
2295H	4 Pcs	12-10 AWG NYLON INSULATED FLAG DISCONNECT
2302H	3 Pcs	22-18 AWG WATERPROOF RING - #10
2308H	3 Pcs	16-14 AWG WATERPROOF RING - #10
2309H	3 Pcs	12-10 AWG WATERPROOF RING - 1/4"
2314H	3 Pcs	12-10 AWG WATERPROOF RING - #10
2355H	3 Pcs	16-14 AWG WATERPROOF SPADE - #10
2370H	3 Pcs	22-18 AWG HEAT SHRINK BUTT CONNECTOR
2371H	3 Pcs	16-14 AWG HEAT SHRINK BUTT CONNECTOR
2372H	3 Pcs	12-10 AWG HEAT SHRINK BUTT CONNECTOR
2375H	3 Pcs	16-14 AWG HEAT SHRINK MALE DISCONNECT - .250"
2376H	3 Pcs	16-14 AWG HEAT SHRINK FEMALE DISCONNECT - .250"
2406F	2 Pcs	AGC GLASS FUSE - 5 AMP
2408F	2 Pcs	AGC GLASS FUSE - 7.5 AMP
2409E	2 Pcs	AGC GLASS FUSE - 10 AMP
2410E	2 Pcs	AGC GLASS FUSE - 15 AMP
2411E	2 Pcs	AGC GLASS FUSE - 20 AMP
2412E	2 Pcs	AGC GLASS FUSE - 25 AMP
2413F	2 Pcs	AGC GLASS FUSE - 30 AMP
2415E	2 Pcs	SFE GLASS FUSE - 4 AMP
2418E	2 Pcs	SFE GLASS FUSE - 9 AMP
2419E	2 Pcs	SFE GLASS FUSE - 14 AMP

wiring accessories master catalog rev3/06

JTT #	QTY.	DESCRIPTION
2420E	2 Pcs	SFE GLASS FUSE - 20 AMP
2421F	2 Pcs	SFE GLASS FUSE - 30 AMP
2425F	2 Pcs	GBC GLASS FUSE - 8 AMP
2427F	2 Pcs	GBC GLASS FUSE - 16 AMP
2428F	2 Pcs	GBC GLASS FUSE - 25 AMP
2430F	2 Pcs	ATC FUSE - 3 AMP
2431E	2 Pcs	ATC FUSE - 5 AMP
2432E	2 Pcs	ATC FUSE - 7.5 AMP
2433E	2 Pcs	ATC FUSE - 10 AMP
2434E	2 Pcs	ATC FUSE - 15 AMP
2435E	2 Pcs	ATC FUSE - 20 AMP
2436F	2 Pcs	ATC FUSE - 25 AMP
2437E	2 Pcs	ATC FUSE - 30 AMP
2450F	1 Pc	GLASS FUSE BLOCK - FOUR POSITION
2452F	1 Pc	JUNCTION BLOCK - FOUR POSITION
2466F	1 Set	12 AWG IN-LINE FUSE HOLDER WITH 15 AMP GLASS FUSE
2467F	1 Set	12 AWG IN-LINE FUSE HOLDER WITH 20 AMP GLASS FUSE
2468F	1 Set	10 AWG IN-LINE FUSE HOLDER WITH 30 AMP GLASS FUSE
2475F	6 Pcs	ATC FUSE KIT
2476H	6 Pcs	AMERICAN VEHICLE FUSE KIT
2477H	6 Pcs	GERMAN VEHICLE FUSE KIT
2478H	6 Pcs	BRITISH/JAPANESE VEHICLE FUSE KIT
2479F	1 Pc	4-WIRE TRAILER WIRE EXTENSION - 2 FOOT
2490F	1 Pc	FUSE PULLER TOOL
2500H	1 Pc	90 DEGREE FEMALE RECEPTACLE
2503H	1 Pc	MOLDED CONNECTOR - 3 POLE
2504-1F	1 Pc	6 ROUND TO 4 FLAT TRAILER WIRE ADAPTER
2504-2F	1 Pc	7 ROUND TO 4 FLAT TRAILER WIRE ADAPTER
2504H	1 Pc	MOLDED CONNECTOR - 4 POLE
2507-1F	1 Pc	MALE AND FEMALE 4-POLE REPLACEMENT PLUG - CHROME
2507-2F	1 Pc	FEMALE 4-POLE REPLACEMENT PLUG - CHROME
2508-1F	1 Pc	MALE AND FEMALE 6-POLE REPLACEMENT PLUG - CHROME
2509F	1 Pc	TRAILER LIGHT CONNECTOR - 5 TO 4
2512F	1 Pc	MOISTURE PROOF CONNECTOR - 4 POLE
2513F	1 Pc	MOISTURE PROOF CONNECTOR - 5 POLE
2514F	1 Pc	MOISTURE PROOF CONNECTOR - 6 POLE
2515F	1 Pc	REPLACEMENT HARNESS - 4 POLE FM
2516F	1 Pc	REPLACEMENT HARNESS - 4 POLE M
2522F	25 Ft	TRAILER RIBBON WIRE - 4 WAY COLOR CODED
2523F	25 Ft	TRAILER RIBBON WIRE - 3 WAY COLOR CODED
2525F	1 Pc	UNIVERSAL SHIELDED LICENSE/UTILITY LIGHT
2526H	2 Pcs	16 AWG IN-LINE FUSE HOLDER WITH 14 AMP GLASS FUSE
2527H	1 Set	12 AWG IN-LINE FUSE HOLDER WITH 30 AMP GLASS FUSE
2528H	1 Pc	16 AWG IN-LINE FUSE HOLDER FOR 1-20 AMP ATC FUSE
2529H	1 Pc	12 AWG IN-LINE FUSE HOLDER FOR 1-30 AMP ATC FUSE
2530H	1 Pc	GM ALTERNATOR REPAIR HARNESS - 1971-ON
2531H	1 Pc	GM ALTERNATOR REPAIR HARNESS - 62-74
2539H	1 Pc	FORD AND AMC VOLTAGE REGULATOR REPAIR HARNESS - 1965-ON
2541H	1 Pc	GM ALTERNATOR EXTENDER HARNESS - 1965-ON
2560F	1 Pc	TAIL LIGHT HOOK-UP SET
2561H	1 Pc	UNIVERSAL DOUBLE CONTACT SOCKET
2562H	1 Pc	UNIVERSAL SINGLE CONTACT SOCKET
2563H	1 Pc	UNIVERSAL MINIATURE BASE SINGLE CONTACT SOCKET
2564H	1 Pc	SEALED BEAM HEADLIGHT CONNECTOR WITH 3 WIRES
2565H	1 Pc	SEALED BEAM HEADLIGHT CONNECTOR WITH 2 WIRES
2568H	1 Pc	SINGLE CONTACT SOCKET FOR GM VEHICLES
2588F	1 Pc	3-POLE HALOGEN HEADLIGHT CONNECTOR
2597H	1 Pc	INSTRUMENT PANEL SOCKET WITH VINYL HOUSING - 5/8"
2598H	1 Pc	INSTRUMENT PANEL SOCKET WITH VINYL HOUSING - 1/2"
2600J	1 Pc	16 AMP ROCKER - RECTANGULAR - BLACK
2602J	1 Pc	16 AMP ILLUMINATED ROCKER - RECTANGULAR - RED
2603F	1 Set	ROCKER & LIGHT COMBO - RECTANGULAR - AMBER
2604F	1 Set	ROCKER & LIGHT COMBO - RECTANGULAR - RED
2605J	1 Pc	16 AMP ILLUMINATED ROCKER - RECTANGULAR - GREEN
2606J	1 Pc	16 AMP ILLUMINATED ROCKER - RECTANGULAR - BLUE
2607J	1 Pc	16 AMP ILLUMINATED ROCKER - RECTANGULAR - AMBER
2609F	1 Pc	16 AMP ILLUMINATED ROCKER - RED LED
2610H	1 Pc	20 AMP DUCKBILL TOGGLE - BLACK
2612J	1 Pc	20 AMP ILLUMINATED TOGGLE - RED
2615J	1 Pc	20 AMP ILLUMINATED TOGGLE - GREEN
2616J	1 Pc	20 AMP ILLUMINATED TOGGLE - BLUE
2617J	1 Pc	20 AMP ILLUMINATED TOGGLE - AMBER
2618F	1 Pc	10 AMP MINI ROCKER WITH LED - BLACK
2620F	1 Pc	20 AMP TOGGLE ON/OFF/ON - BLACK

JTT #	QTY.	DESCRIPTION
2622J	1 Pc	20 AMP ILLUMINATED DUCKBILL TOGGLE - RED
2625J	1 Pc	20 AMP ILLUMINATED DUCKBILL TOGGLE - GREEN
2626J	1 Pc	20 AMP ILLUMINATED DUCKBILL TOGGLE - BLUE
2627J	1 Pc	20 AMP ILLUMINATED DUCKBILL TOGGLE - AMBER
2630F	1 Pc	20 AMP TOGGLE - BLACK - MOMENTARY ON/OFF
2632H	1 Pc	16 AMP WARNING LIGHT WITH MALE TERMINALS - RED
2633F	1 Pc	16 AMP WARNING LIGHT - RED 1/4" FLUSH MOUNT
2635H	1 Pc	16 AMP WARNING LIGHT WITH MALE TERMINALS - GREEN
2636H	1 Pc	16 AMP WARNING LIGHT WITH MALE TERMINALS - BLUE
2637H	1 Pc	16 AMP WARNING LIGHT WITH MALE TERMINALS - AMBER
2640H	1 Pc	20 AMP TOGGLE ON/OFF - BLACK
2641F	1 Pc	15 AMP BAKELIGHT TOGGLE WITH TWO SCREW TERMINALS
2642F	1 Pc	25 AMP HEAVY-DUTY TOGGLE - ON/OFF
2643F	1 Pc	25 AMP HEAVY-DUTY TOGGLE - MARINE ON/OFF
2644F	1 Pc	25 AMP HEAVY-DUTY TOGGLE - MARINE ON/OFF/ON
2648F	1 Pc	30 AMP HEAVY-DUTY TOGGLE - MOM. ON/OFF/MOM.ON
2650E	1 Pc	SWITCH PANEL MOUNT - ROUND - 1-HOLE
2651E	1 Pc	SWITCH PANEL MOUNT - RECTANGULAR - 1-HOLE
2652-5F	1 Pc	TOGGLE GUARD - GREEN
2652-6F	1 Pc	TOGGLE GUARD - BLUE
2652-7F	1 Pc	TOGGLE GUARD - YELLOW
2652F	1 Pc	TOGGLE GUARD - RED
2653-1J	1 Pc	15 AMP TOGGLE WITH RED LED
2653J	1 Pc	20 AMP ALL-METAL TOGGLE ON/OFF
2659F	1 Pc	TOGGLE BOOT
2670F	1 Pc	15 AMP PUSH-PULL SWITCH - RED
2672F	1 Pc	16 AMP WARNING LIGHT WITH LEADS - RED
2673F	1 Pc	16 AMP WARNING LIGHT WITH LEADS - GREEN
2676F	1 Pc	16 AMP WARNING LIGHT WITH LEADS - BLUE
2677F	1 Pc	16 AMP WARNING LIGHT WITH LEADS - AMBER
2681F	1 Pc	60 AMP HEAVY-DUTY MOISTURE PROOF MOM. ON PUSH/PULL SWITCH
2683F	1 Pc	10 AMP MOMENTARY ON PUSH BUTTON SWITCH
2689F	1 Pc	5 AMP FLUSH MOUNT HORN BUTTON
2691F	1 Pc	15 AMP FUSED OFF/ON/ON THREE POSITION PUSH-PULL SWITCH
2700-2J	1 Pc	10 AMP ILLUMINATED ROCKER - ROUND - RED
2700-4J	1 Pc	10 AMP ILLUMINATED ROCKER - ROUND - AMBER
2700-5J	1 Pc	10 AMP ILLUMINATED ROCKER - ROUND - GREEN
2700-6J	1 Pc	10 AMP ILLUMINATED ROCKER - ROUND - BLUE
2700J	1 Pc	10 AMP ROCKER - ROUND - BLACK
2701-2J	1 Pc	10 AMP ROCKER - ROUND - RED LED
2701-4J	1 Pc	10 AMP ROCKER - ROUND - AMBER LED
2701-5J	1 Pc	10 AMP ROCKER - ROUND - GREEN LED
2702-2J	1 Pc	10 AMP ILLUMINATED ROCKER - OVAL - RED
2702-4J	1 Pc	16 AMP ILLUMINATED ROCKER - OVAL - AMBER
2702-5J	1 Pc	16 AMP ILLUMINATED ROCKER - OVAL - GREEN
2703-2J	1 Pc	16 AMP ILLUMINATED ROCKER - OVAL - RED LED
2703-4J	1 Pc	16 AMP ILLUMINATED ROCKER - OVAL - AMBER LED
2703-5J	1 Pc	16 AMP ILLUMINATED ROCKER - OVAL - GREEN LED
2800F	1 Pc	FORD ALTERNATOR HARNESS - 1981-89
2841F	1 Pc	GM ALTERNATOR CONNECTOR PIGTAIL - 87-90
284768-8	50 Pcs	WIRE CLAMP WITH ADHESIVE BASE
2865F	1 Set	14 AWG WEATHERPACK M/FM CONNECTOR WITH 1 WIRE
2866F	1 Set	14 AWG WEATHERPACK M/FM CONNECTOR WITH 2 WIRE
2867F	1 Set	14 AWG WEATHERPACK M/FM CONNECTOR WITH 3 WIRE
2868F	1 Set	14 AWG WEATHERPACK M/FM CONNECTOR WITH 4 WIRE
2900F	1 Pc	16 AMP JUMBO ROCKER - BLACK
2902F	1 Pc	16 AMP ILLUMINATED JUMBO ROCKER - RED
2905F	1 Pc	16 AMP ILLUMINATED JUMBO ROCKER - GREEN
2906F	1 Pc	16 AMP ILLUMINATED JUMBO ROCKER - BLUE
2907F	1 Pc	16 AMP ILLUMINATED JUMBO ROCKER - AMBER
2910F	1 Pc	16 AMP EURO-STYLE ON/OFF PUSH-PULL SWITCH
2913F	1 Pc	50 AMP ALL-METAL TOGGLE ON/OFF
2918F	1 Pc	50 AMP ALL-METAL TOGGLE ON/OFF/ON
2941F	1 Pc	15 AMP BAKELIGHT TOGGLE - W/ INTEGRATED WIRE LEADS
2950F	1 Pc	SWITCH PANEL MOUNT - ROUND - 2-HOLE
2951F	1 Pc	SWITCH PANEL MOUNT - ROUND - 3-HOLE
2952F	1 Pc	SWITCH PANEL MOUNT - ROUND - 4-HOLE
2953F	1 Pc	SWITCH PANEL MOUNT - RECTANGULAR - 2-HOLE
2954F	1 Pc	SWITCH PANEL MOUNT - RECTANGULAR - 3-HOLE
2955F	1 Pc	SWITCH PANEL MOUNT - RECTANGULAR - 4-HOLE
2965F	1 Pc	15 AMP ILLUMINATED PUSH-PULL SWITCH - GREEN
2966F	1 Pc	15 AMP ILLUMINATED PUSH-PULL SWITCH - BLUE
2967F	1 Pc	15 AMP ILLUMINATED PUSH-PULL SWITCH - AMBER
2980F	1 Set	ILLUMINATED RED ROCKER MOUNTED COMBO

JTT #	QTY.	DESCRIPTION
2982F	1 Pc	ILLUMINATED RED TOGGLE MOUNTED COMBO
2984F	1 Set	TOGGLE WITH RED INDICATOR MOUNTED COMBO
2986F	1 Set	ILLUMINATED RED AND BLUE TOGGLES MOUNTED COMBO
30-1020	1 Pc	SMART GLOW MAXI FUSE - 20 AMP
30-1030	1 Pc	SMART GLOW MAXI FUSE - 30 AMP
30-1040	1 Pc	SMART GLOW MAXI FUSE - 40 AMP
30-1050	1 Pc	SMART GLOW MAXI FUSE - 50 AMP
30-1060	1 Pc	SMART GLOW MAXI FUSE - 60 AMP
30-1070	1 Pc	SMART GLOW MAXI FUSE - 70 AMP
30-1080	1 Pc	SMART GLOW MAXI FUSE - 80 AMP
30-1100	1 Pc	SMART GLOW MAXI FUSE - 100 AMP
4004H	7 Pcs	HEAT SHRINK TUBING 4" CUT - BLACK - 3/16"
4005H	6 Pcs	HEAT SHRINK TUBING 4" CUT - BLACK - 1/4"
4006H	6 Pcs	HEAT SHRINK TUBING 4" CUT - BLACK - 3/8"
4051H	8 Pcs	HEAT SHRINK TUBING 4" CUT - BLACK - ASSORTMENT
4052H	5 Pcs	HEAT SHRINK TUBING 4" CUT - BLACK - ASSORTMENT
4053H	7 Pcs	HEAT SHRINK TUBING 4" CUT - BLACK - ASSORTMENT
4057H	10 Pcs	HEAT SHRINK TUBING 4" CUT - RAINBOW - 3/16"
4058H	5 Pcs	HEAT SHRINK TUBING 4" CUT - RAINBOW - 1/4"
4059H	5 Pcs	HEAT SHRINK TUBING 4" CUT - RAINBOW - 3/8"
4304F	14 Ft	FLEX GUARD SPLIT LOOM - BLACK - 1/4"
4305F	10 Ft	FLEX GUARD SPLIT LOOM - BLACK - 3/8"
4306F	7 Ft	FLEX GUARD SPLIT LOOM - BLACK - 1/2"
4307F	5 Ft	FLEX GUARD SPLIT LOOM - BLACK - 3/4"
4402H	13 Pcs	VINYL GROMMETS - 3/8"
4404H	11 Pcs	VINYL GROMMETS - 1/2"
4405H	7 Pcs	VINYL GROMMETS - 5/8"
4408H	4 Pcs	VINYL GROMMETS - 1"
4450H	13 Pcs	VINYL GROMMETS - ASSORTMENT
4452H	5 Pcs	VINYL GROMMETS - ASSORTMENT
4453H	15 Pcs	VINYL GROMMETS - ASSORTMENT
4468F	10 Pcs	STEEL SANTOPRENE INSULATED CLAMPS - 1/2"
4470F	10 Pcs	STEEL SANTOPRENE INSULATED CLAMPS - 5/8"
4472F	10 Pcs	STEEL SANTOPRENE INSULATED CLAMPS - 3/4"
4476F	10 Pcs	STEEL SANTOPRENE INSULATED CLAMPS - 1"
4490F	10 Pcs	STEEL SANTOPRENE INSULATED CLAMPS - ASSORTED
4602H	25 Pcs	NYLON CABLE CLAMP - NATURAL - 1/4"
4603H	25 Pcs	NYLON CABLE CLAMP - NATURAL - 5/16"
4604H	22 Pcs	NYLON CABLE CLAMP - NATURAL - 3/8"
4605H	15 Pcs	NYLON CABLE CLAMP - NATURAL - 7/16"
4606H	15 Pcs	NYLON CABLE CLAMP - NATURAL - 1/2"
4650H	18 Pcs	NYLON CABLE CLAMP ASSORTMENT - 1/8", 3/16", 1/4"
4701-2H	31 Pcs	WIRE TIE 4" - RED
4701-6H	31 Pcs	WIRE TIE 4" - BLUE
4701-7H	31 Pcs	WIRE TIE 4" - YELLOW
4701H	31 Pcs	WIRE TIE 4" - NATURAL
4702H	31 Pcs	WIRE TIE 4" - UV BLACK
4703-2H	25 Pcs	WIRE TIE 5.5" - RED
4703-6H	25 Pcs	WIRE TIE 5.5" - BLUE
4703-7H	25 Pcs	WIRE TIE 5.5" - YELLOW
4703H	25 Pcs	WIRE TIE 5.5" - NATURAL
4704H	25 Pcs	WIRE TIE 5.5" - UV BLACK
4705-2H	14 Pcs	WIRE TIE 7.5" - RED
4705-6H	14 Pcs	WIRE TIE 7.5" - BLUE
4705-7H	14 Pcs	WIRE TIE 7.5" - YELLOW
4705H	14 Pcs	WIRE TIE 7.5" - NATURAL
4706H	14 Pcs	WIRE TIE 7.5" - UV BLACK
4707-2H	14 Pcs	WIRE TIE 11.5" - RED
4707-6H	14 Pcs	WIRE TIE 11.5" - BLUE
4707-7H	14 Pcs	WIRE TIE 11.5" - YELLOW
4707H	14 Pcs	WIRE TIE 11.5" - NATURAL
4708H	14 Pcs	WIRE TIE 11.5" - UV BLACK
4735H	10 Pcs	WIRE TIE MOUNT - ADHESIVE OR SCREW MOUNT
5003F	1 Pc	CRIMPING TOOL - DELUXE
5011F	1 Pc	CRIMPING TOOL - RACHETING
5020F	1 Pc	E-Z STRIPPER / CRIMPER - HEAVY-DUTY
5021F	1 Pc	TECHNICIANS POCKET TORCH - ANGLED HEAD
5022F	1 Pc	TECHNICIANS POCKET TORCH - STRAIGHT HEAD
6992F	1 Set	DELUXE WIRING KIT - 101 Pcs
7785F	1 Pc	DISTRIBUTION BLOCK - RECTANGULAR - GOLD
7786F	1 Pc	DISTRIBUTION BLOCK - TRIANGULAR - GOLD
7930F	2 Sets	FUSE POWER TAP FOR GLASS FUSE - COMBO
7931F	2 Sets	FUSE POWER TAP FOR ATC/AFO FUSE - COMBO

## The JT&T Wiring Accessories Merchandiser

Tune up your sales with a new 8900 Merchandiser. Available in Spinner or Gondola form, the 8900 Merchandisers will maximize your revenues while minimizing the amount of used floor space.

- 460 top-selling SKUs
- Fast set-up, easy restock
- Customer friendly organization
- Less than 4 square feet of retail space
- Also available as a Gondola

# CALL ABOUT THE JT&T NOW PROGRAM

## 800.633.3655

### SEE BACK COVER FOR DETAILS

sales@thebestconnection.com | www.jttproducts.com



Ordering is easy!  
Electronic Data Interchange  
Phone, Fax, Email

**8900RV RV Spinner Merchandiser**  
262 SKUs



JTT #	QTY.	DESCRIPTION
100F	8 Ft	10 AWG PRIMARY WIRE - BLACK
102F	8 Ft	10 AWG PRIMARY WIRE - RED
105F	8 Ft	10 AWG PRIMARY WIRE - GREEN
106F	8 Ft	10 AWG PRIMARY WIRE - BLUE
107F	8 Ft	10 AWG PRIMARY WIRE - YELLOW
108F	8 Ft	10 AWG PRIMARY WIRE - BROWN
109F	8 Ft	10 AWG PRIMARY WIRE - WHITE
120F	12 Ft	12 AWG PRIMARY WIRE - BLACK
122F	12 Ft	12 AWG PRIMARY WIRE - RED
125F	12 Ft	12 AWG PRIMARY WIRE - GREEN
126F	12 Ft	12 AWG PRIMARY WIRE - BLUE
127F	12 Ft	12 AWG PRIMARY WIRE - YELLOW
128F	12 Ft	12 AWG PRIMARY WIRE - BROWN
129F	12 Ft	12 AWG PRIMARY WIRE - WHITE
140F	15 Ft	14 AWG PRIMARY WIRE - BLACK
142F	15 Ft	14 AWG PRIMARY WIRE - RED
145F	15 Ft	14 AWG PRIMARY WIRE - GREEN
146F	15 Ft	14 AWG PRIMARY WIRE - BLUE
147F	15 Ft	14 AWG PRIMARY WIRE - YELLOW
148F	15 Ft	14 AWG PRIMARY WIRE - BROWN
149F	15 Ft	14 AWG PRIMARY WIRE - WHITE
160F	20 Ft	16 AWG PRIMARY WIRE - BLACK
162F	20 Ft	16 AWG PRIMARY WIRE - RED
165F	20 Ft	16 AWG PRIMARY WIRE - GREEN
166F	20 Ft	16 AWG PRIMARY WIRE - BLUE
167F	20 Ft	16 AWG PRIMARY WIRE - YELLOW
168F	20 Ft	16 AWG PRIMARY WIRE - BROWN
169F	20 Ft	16 AWG PRIMARY WIRE - WHITE
180F	30 Ft	18 AWG PRIMARY WIRE - BLACK
182F	30 Ft	18 AWG PRIMARY WIRE - RED
185F	30 Ft	18 AWG PRIMARY WIRE - GREEN
186F	30 Ft	18 AWG PRIMARY WIRE - BLUE
187F	30 Ft	18 AWG PRIMARY WIRE - YELLOW
188F	30 Ft	18 AWG PRIMARY WIRE - BROWN
189F	30 Ft	18 AWG PRIMARY WIRE - WHITE
218H	6 Pcs	TEST CLIPS - 2"
219F	1 Set	TEST LEADS - RED AND BLACK WITH 30" WIRE
220H	2 Sets	MINI TEST CLIP - 1" COMBO PACK
222F	25 Ft	SPEAKER WIRE - 2 WIRE
230F	1 Pc	DELUXE CIRCUIT TESTER
233F	1 Pc	POCKET AUTOMOTIVE TESTER
235F	1 Pc	BATTERY ANALYZER/TESTER
241H	4 Pcs	CHARGING CLIP - 10 AMP
10-1001	2 Pcs	SMART GLOW AGC FUSE - 10 AMP
10-1002	2 Pcs	SMART GLOW AGC FUSE - 15 AMP
10-1003	2 Pcs	SMART GLOW AGC FUSE - 20 AMP
10-1005	2 Pcs	SMART GLOW AGC FUSE - 30 AMP
11-1001	2 Pcs	SMART GLOW MINI FUSE - 10 AMP
11-1002	2 Pcs	SMART GLOW MINI FUSE - 15 AMP
11-1003	2 Pcs	SMART GLOW MINI FUSE - 20 AMP
1208H	10 Pcs	FUSE POWER TAP FOR ATC/ATO FUSE - 250 TAB
1212H	19 Pcs	FUSE POWER TAP FOR GLASS FUSE - 250 TAB
1213H	9 Pcs	16-14 AWG INSL NYLON DOUBLE BULLET RECP - 157"
1216H	15 Pcs	22-14 AWG CLOSED END CONNECTOR - NYLON
1217H	10 Pcs	12-10 AWG CLOSED END CONNECTOR - NYLON
1220-1H	7 Pcs	18-14 AWG MID-LINE TAP - WHITE - NO-STOP

JTT #	QTY.	DESCRIPTION
1220-2H	6 Pcs	22-16 AWG MID-LINE TAP - RED - W/ STOP
1220H	6 Pcs	18-14 AWG TAP SPLICE CONNECTOR - BLUE - W/ STOP
1222H	6 Pcs	18-12 AWG TWIST CONNECTOR - SOFT VINYL - YELLOW
1223H	6 Pcs	16-10 AWG TWIST CONNECTOR - SOFT VINYL - RED
1232H	2 Pcs	FUSE HOLDER - SELF-STRIPPING - 1-20 AMP ATC FUSE
1305F	5 Pcs	6 AWG SEAMLESS COPPER LUG - 3/8" STUD
1309F	5 Pcs	4 AWG SEAMLESS COPPER LUG - 3/8" STUD
1314F	5 Pcs	2 AWG SEAMLESS COPPER LUG - 3/8" STUD
2002H	19 Pcs	22-18 AWG VINYL INSULATED RING - #10
2003H	14 Pcs	22-18 AWG VINYL INSULATED RING - 1/4"
2006H	19 Pcs	16-14 AWG VINYL INSULATED RING - #6
2007H	19 Pcs	16-14 AWG VINYL INSULATED RING - #8
2008H	19 Pcs	16-14 AWG VINYL INSULATED RING - #10
2009H	14 Pcs	16-14 AWG VINYL INSULATED RING - 1/4"
2010H	14 Pcs	16-14 AWG VINYL INSULATED RING - 5/16"
2011H	14 Pcs	16-14 AWG VINYL INSULATED RING - 3/8"
2013H	14 Pcs	12-10 AWG VINYL INSULATED RING - #8
2014H	14 Pcs	12-10 AWG VINYL INSULATED RING - #10
2015H	12 Pcs	12-10 AWG VINYL INSULATED RING - 1/4"
2016H	12 Pcs	12-10 AWG VINYL INSULATED RING - 5/16"
2017H	12 Pcs	12-10 AWG VINYL INSULATED RING - 3/8"
2018H	7 Pcs	12-10 AWG VINYL INSULATED RING - 1/2"
2020H	4 Pcs	8 AWG HEAVY-DUTY VINYL INSULATED RING - 1/4"
2021H	4 Pcs	8 AWG HEAVY-DUTY VINYL INSULATED RING - 5/16"
2022H	4 Pcs	8 AWG HEAVY-DUTY VINYL INSULATED RING - 3/8"
20301F	2 Pcs	MINI FUSE - 3 AMP
20303F	2 Pcs	MINI FUSE - 5 AMP
20304F	2 Pcs	MINI FUSE - 7.5 AMP
20305F	2 Pcs	MINI FUSE - 10 AMP
20307F	2 Pcs	MINI FUSE - 20 AMP
20308F	2 Pcs	MINI FUSE - 25 AMP
20310F	1 Pc	MAXI FUSE - 20 AMP
20311F	1 Pc	MAXI FUSE - 30 AMP
20312F	1 Pc	MAXI FUSE - 40 AMP
20313F	1 Pc	MAXI FUSE - 50 AMP
20314F	1 Pc	MAXI FUSE - 60 AMP
20315F	1 Pc	MAXI FUSE - 80 AMP
20325F	1 Pc	12 AWG FUSE HOLDER - HD WATERPROOF - 3-30 AMP ATC FUSE
204712-1	8 Pcs	WIRE TIE 14.5" - UV BLACK
2052H	19 Pcs	22-18 AWG VINYL INSULATED SPADE - #10
2054H	19 Pcs	16-14 AWG VINYL INSULATED SPADE - #8
2055H	19 Pcs	16-14 AWG VINYL INSULATED SPADE - #10
2058H	14 Pcs	12-10 AWG VINYL INSULATED SPADE - #10
2060H	20 Pcs	22-18 AWG VINYL INSULATED BUTT CONNECTOR
2061H	20 Pcs	16-14 AWG VINYL INSULATED BUTT CONNECTOR
2062H	14 Pcs	12-10 AWG VINYL INSULATED BUTT CONNECTOR
2063H	2 Pcs	8 AWG HEAVY-DUTY VINYL INSULATED BUTT CONNECTOR
2065H	14 Pcs	22-18 AWG NYLON INSULATED BUTT CONNECTOR
2066H	14 Pcs	16-14 AWG NYLON INSULATED BUTT CONNECTOR
2067H	8 Pcs	12-10 AWG NYLON INSULATED BUTT CONNECTOR
2102H	19 Pcs	22-18 AWG VINYL INSULATED FEMALE DISCONNECT - .250"
2103H	19 Pcs	22-18 AWG VINYL INSULATED MALE DISCONNECT - .250"
2104H	19 Pcs	16-14 AWG VINYL INSULATED FEMALE DISCONNECT - .187"
2105H	20 Pcs	16-14 AWG VINYL INSULATED FEMALE DISCONNECT - .250"
2106H	19 Pcs	16-14 AWG VINYL INSULATED MALE DISCONNECT - .250"
2107H	15 Pcs	12-10 AWG VINYL INSULATED FEMALE DISCONNECT - .250"
2108H	15 Pcs	12-10 AWG VINYL INSULATED MALE DISCONNECT - .250"
2109H	9 Pcs	16-14 AWG VINYL INSULATED PIGGYBACK
2111H	20 Pcs	16-14 AWG VINYL INSULATED BULLET CONNECTOR - MALE - .157"
2112H	7 Pcs	16-14 AWG VINYL INSULATED BULLET CONNECTOR - FEMALE - .157"
2113H	7 Pcs	12-10 AWG VINYL INSULATED FEMALE DISCONNECT - .375"
2114H	10 Pcs	22-18 AWG NYLON FULLY INSULATED FEMALE DISCONNECT - .250"
2115H	10 Pcs	22-18 AWG NYLON FULLY INSULATED MALE DISCONNECT - .250"
2116H	10 Pcs	16-14 AWG NYLON FULLY INSULATED FEMALE DISCONNECT - .250"
2117H	10 Pcs	16-14 AWG NYLON FULLY INSULATED MALE DISCONNECT - .250"
2118H	7 Pcs	12-10 AWG NYLON FULLY INSULATED FEMALE DISCONNECT - .250"
2119H	7 Pcs	12-10 AWG NYLON FULLY INSULATED MALE DISCONNECT - .250"
2121H	5 Sets	16-14 AWG VINYL INSULATED DISCONNECT COMBO
2122H	4 Sets	16-14 AWG T-TAP WITH FULLY INSULATED DISCONNECT COMBO
2155H	18 Pcs	22-10 AWG MIXED DISCONNECT ASSORTMENT
2156H	17 Pcs	22-10 AWG VINYL INSULATED BUTT CONNECTOR COMBO
2158H	12 Pcs	22-12 AWG TWIST CONNECTOR ASSORTMENT
2379F	9 Pcs	SOLDER SEAL BUTT CONNECTOR - COMBO PACK
2408F	2 Pcs	AGC GLASS FUSE - 7.5 AMP
2409E	2 Pcs	AGC GLASS FUSE - 10 AMP
2412E	2 Pcs	AGC GLASS FUSE - 25 AMP
2431E	2 Pcs	ATC FUSE - 5 AMP
2433E	2 Pcs	ATC FUSE - 10 AMP
2434E	2 Pcs	ATC FUSE - 15 AMP
2435E	2 Pcs	ATC FUSE - 20 AMP
2436F	2 Pcs	ATC FUSE - 25 AMP
2437E	2 Pcs	ATC FUSE - 30 AMP
2475F	6 Pcs	ATC FUSE KIT
2476H	6 Pcs	AMERICAN VEHICLE FUSE KIT
2503H	1 Pc	MOLDED CONNECTOR - 3 POLE
2504H	1 Pc	MOLDED CONNECTOR - 4 POLE
2505F	1 Set	TRUNK/TRAILER KIT - 4 WAY
2509F	1 Pc	TRAILER LIGHT CONNECTOR - 5 TO 4
2512F	1 Pc	MOISTURE PROOF CONNECTOR - 4 POLE
2513F	1 Pc	MOISTURE PROOF CONNECTOR - 5 POLE
2514F	1 Pc	MOISTURE PROOF CONNECTOR - 6 POLE
2515F	1 Pc	REPLACEMENT HARNESS - 4 POLE FM
2516F	1 Pc	REPLACEMENT HARNESS - 4 POLE M
2522F	25 Ft	TRAILER RIBBON WIRE - 4 WAY COLOR CODED
2523F	25 Ft	TRAILER RIBBON WIRE - 3 WAY COLOR CODED
2526H	2 Pcs	16 AWG IN-LINE FUSE HOLDER WITH 14 AMP GLASS FUSE
2527H	1 Set	12 AWG IN-LINE FUSE HOLDER WITH 30 AMP GLASS FUSE
2528H	1 Pc	16 AWG IN-LINE FUSE HOLDER FOR 1-20 AMP ATC FUSE

JTT #	QTY.	DESCRIPTION
2529H	1 Pc	12 AWG IN-LINE FUSE HOLDER FOR 1-30 AMP ATC FUSE
2560F	1 Pc	TAIL LIGHT HOOK-UP SET
2600J	1 Pc	16 AMP ROCKER - RECTANGULAR - BLACK
2602J	1 Pc	16 AMP ILLUMINATED ROCKER - RECTANGULAR - RED
2603F	1 Set	ROCKER & LIGHT COMBO - RECTANGULAR - AMBER
2604F	1 Set	ROCKER & LIGHT COMBO - RECTANGULAR - RED
2605J	1 Pc	16 AMP ILLUMINATED ROCKER - RECTANGULAR - GREEN
2606J	1 Pc	16 AMP ILLUMINATED ROCKER - RECTANGULAR - BLUE
2607J	1 Pc	16 AMP ILLUMINATED ROCKER - RECTANGULAR - AMBER
2610H	1 Pc	20 AMP DUCKBILL TOGGLE - BLACK
2616J	1 Pc	20 AMP ILLUMINATED TOGGLE - BLUE
2617J	1 Pc	20 AMP ILLUMINATED TOGGLE - AMBER
2618F	1 Pc	10 AMP MINI ROCKER WITH LED - BLACK
2620F	1 Pc	20 AMP TOGGLE ON/OFF - ON - BLACK
2622J	1 Pc	20 AMP ILLUMINATED DUCKBILL TOGGLE - RED
2632H	1 Pc	16 AMP WARNING LIGHT WITH MALE TERMINALS - RED
2633F	1 Pc	16 AMP WARNING LIGHT - RED 1/4" FLUSH MOUNT
2635H	1 Pc	16 AMP WARNING LIGHT WITH MALE TERMINALS - GREEN
2636H	1 Pc	16 AMP WARNING LIGHT WITH MALE TERMINALS - BLUE
2637H	1 Pc	16 AMP WARNING LIGHT WITH MALE TERMINALS - AMBER
2640H	1 Pc	20 AMP TOGGLE ON/OFF - BLACK
2643F	1 Pc	25 AMP HEAVY-DUTY TOGGLE - MARINE ON/OFF
2644F	1 Pc	25 AMP HEAVY-DUTY TOGGLE - MARINE ON/OFF/ON
2648F	1 Pc	30 AMP HEAVY-DUTY TOGGLE - MOM. ON/OFF/MOM.ON
2650E	1 Pc	SWITCH PANEL MOUNT - ROUND - 1-HOLE
2651E	1 Pc	SWITCH PANEL MOUNT - RECTANGULAR - 1-HOLE
2652-5F	1 Pc	TOGGLE GUARD - GREEN
2652-6F	1 Pc	TOGGLE GUARD - BLUE
2652-7F	1 Pc	TOGGLE GUARD - YELLOW
2652F	1 Pc	TOGGLE GUARD - RED
2653-1J	1 Pc	15 AMP TOGGLE WITH RED LED
2659F	1 Pc	TOGGLE BOOT
2700J	1 Pc	10 AMP ROCKER - ROUND - BLACK
2701-2J	1 Pc	10 AMP ROCKER - ROUND - RED LED
2701-4J	1 Pc	10 AMP ROCKER - ROUND - AMBER LED
2701-5J	1 Pc	10 AMP ROCKER - ROUND - GREEN LED
2703-2J	1 Pc	16 AMP ILLUMINATED ROCKER - OVAL - RED LED
2703-4J	1 Pc	16 AMP ILLUMINATED ROCKER - OVAL - AMBER LED
2703-5J	1 Pc	16 AMP ILLUMINATED ROCKER - OVAL - GREEN LED
2941F	1 Pc	15 AMP BAKELIGHT TOGGLE - W/ INTEGRATED WIRE LEADS
2950F	1 Pc	SWITCH PANEL MOUNT - ROUND - 2-HOLE
2951F	1 Pc	SWITCH PANEL MOUNT - ROUND - 3-HOLE
2952F	1 Pc	SWITCH PANEL MOUNT - ROUND - 4-HOLE
2953F	1 Pc	SWITCH PANEL MOUNT - RECTANGULAR - 2-HOLE
2954F	1 Pc	SWITCH PANEL MOUNT - RECTANGULAR - 3-HOLE
2955F	1 Pc	SWITCH PANEL MOUNT - RECTANGULAR - 4-HOLE
2980F	1 Set	ILLUMINATED RED ROCKER MOUNTED COMBO
2982F	1 Pc	ILLUMINATED RED TOGGLE MOUNTED COMBO
2984F	1 Set	TOGGLE WITH RED INDICATOR MOUNTED COMBO
2986F	1 Set	ILLUMINATED RED AND BLUE TOGGLES MOUNTED COMBO
30-1030	1 Pc	SMART GLOW MAXI FUSE - 30 AMP
30-1050	1 Pc	SMART GLOW MAXI FUSE - 50 AMP
4004H	7 Pcs	HEAT SHRINK TUBING 4" CUT - BLACK - 3/16"
4005H	6 Pcs	HEAT SHRINK TUBING 4" CUT - BLACK - 1/4"
4006H	6 Pcs	HEAT SHRINK TUBING 4" CUT - BLACK - 3/8"
4051H	8 Pcs	HEAT SHRINK TUBING 4" CUT - BLACK - ASSORTMENT
4052H	5 Pcs	HEAT SHRINK TUBING 4" CUT - BLACK - ASSORTMENT
4304F	14 Ft	FLEX GUARD SPLIT LOOM - BLACK - 1/4"
4305F	10 Ft	FLEX GUARD SPLIT LOOM - BLACK - 3/8"
4306F	7 Ft	FLEX GUARD SPLIT LOOM - BLACK - 1/2"
4307F	5 Ft	FLEX GUARD SPLIT LOOM - BLACK - 3/4"
4402H	13 Pcs	VINYL GROMMETS - 3/8"
4404H	11 Pcs	VINYL GROMMETS - 1/2"
4405H	7 Pcs	VINYL GROMMETS - 5/8"
4450H	13 Pcs	VINYL GROMMETS - ASSORTMENT
4452H	5 Pcs	VINYL GROMMETS - ASSORTMENT
4453H	15 Pcs	VINYL GROMMETS - ASSORTMENT
4602H	25 Pcs	NYLON CABLE CLAMP - NATURAL - 1/4"
4603H	25 Pcs	NYLON CABLE CLAMP - NATURAL - 5/16"
4604H	22 Pcs	NYLON CABLE CLAMP - NATURAL - 3/8"
4605H	15 Pcs	NYLON CABLE CLAMP - NATURAL - 7/16"
4606H	15 Pcs	NYLON CABLE CLAMP - NATURAL - 1/2"
4650H	18 Pcs	NYLON CABLE CLAMP ASSORTMENT - 1/8", 3/16", 1/4"
4701-2H	31 Pcs	WIRE TIE 4" - RED
4701-6H	31 Pcs	WIRE TIE 4" - BLUE
4701-7H	31 Pcs	WIRE TIE 4" - YELLOW
4701H	31 Pcs	WIRE TIE 4" - NATURAL
4702H	31 Pcs	WIRE TIE 4" - UV BLACK
4703-2H	25 Pcs	WIRE TIE 5.5" - RED
4703-6H	25 Pcs	WIRE TIE 5.5" - BLUE
4703-7H	25 Pcs	WIRE TIE 5.5" - YELLOW
4703H	25 Pcs	WIRE TIE 5.5" - NATURAL
4704H	25 Pcs	WIRE TIE 5.5" - UV BLACK
4705-2H	14 Pcs	WIRE TIE 7.5" - RED
4705-6H	14 Pcs	WIRE TIE 7.5" - BLUE
4705-7H	14 Pcs	WIRE TIE 7.5" - YELLOW
4705H	14 Pcs	WIRE TIE 7.5" - NATURAL
4706H	14 Pcs	WIRE TIE 7.5" - UV BLACK
4707-2H	14 Pcs	WIRE TIE 11.5" - RED
4707-6H	14 Pcs	WIRE TIE 11.5" - BLUE
4707-7H	14 Pcs	WIRE TIE 11.5" - YELLOW
4707H	14 Pcs	WIRE TIE 11.5" - NATURAL
4708H	14 Pcs	WIRE TIE 11.5" - UV BLACK
4709H	8 Pcs	WIRE TIE 14.5" - NATURAL
4725H	13 Pcs	WIRE TIE 7.5" - BLK - SCREW MOUNT
5002F	1 Pc	CRIMPING TOOL - ECONOMY
5003F	1 Pc	CRIMPING TOOL - DELUXE
5008F	1 Pc	EZ STRIPPER/CRIMPER - ECONOMY
5011F	1 Pc	CRIMPING TOOL - RACHETING
5020F	1 Pc	E-Z STRIPPER / CRIMPER - HEAVY-DUTY
5021F	1 Pc	TECHNIAN'S POCKET TORCH
5022F	1 Pc	TECHNIAN'S POCKET TORCH
6982F	83 Pcs	ELECTRICAL TERMINAL KIT
6992F	1 Set	DELUXE WIRING KIT - 101 Pcs
7785F	1 Pc	DISTRIBUTION BLOCK - RECTANGULAR - GOLD
7786F	1 Pc	DISTRIBUTION BLOCK - TRIANGULAR - GOLD
7930F	2 Sets	FUSE POWER TAP FOR GLASS FUSE - COMBO
7931F	2 Sets	FUSE POWER TAP FOR ATC/ATO FUSE - COMBO

wiring accessories master catalog rev306



## Spark Plug Boot Insulators

1200° F Protection  
High-Temperature braided fiberglass protects spark plugs and wire from extreme engine heat.

- 4200T-4F Spark Plug Boot Kit (4 Pcs)
- 4200T-6F Spark Plug Boot Kit (6 Pcs)
- 4200T-8F Spark Plug Boot Kit (8 Pcs)



## High-Temp, Aluminized Fiberglass Wrap

- Can be wrapped around critical wiring or components.
  - Protects up to 600°
- 4216F Thermashield Tube 3/4"
  - 4220F Thermashield Tube 1.5"



## High Temp Braided Fiberglass Hose

- 1,200° protection!
- Constant, high degree protection from engine heat.
  - Remains flexible - Will not melt, scorch or burn.

4221F 3/8" X 6'



## High Temp Fiberglass/Silicone Slewing

- Heavy-duty, silicone-covered fiberglass sleeve for durability.
- Protects fuel lines, assemblies and hydraulic lines up to 500°
- Resists welding sparks, oils, solvents and abrasion.

4215F 3/4" x 4'



## Motorcycle Dress-up Kit

- Give your bike a customized look!
- Protects up to 257° F (continuous operating temperature).
- Provides resistance to abrasion and wear.

- 4210F Chrome
- 4210-0F Black
- 4210-1F Clear
- 4210-17F Carbon



## V8 Muscle Car Dress Up Kits

- For all modern and classic V8's
- Customized look!
- Protects up to 257° F (continuous operating temperature).
- Provides resistance to abrasion and wear.

- 4211F Chrome (Super)
- 4211-0F Black
- 4211-2F Red
- 4211-6F Blue
- 4211-17F Carbon



## Import Car Dress Up Kits

- 4212F Chrome (Super)
- 4212-0F Black
- 4212-11F Neon Green
- 4212-13F Neon Yellow
- 4212-15F Neon Blue
- 4212-17F Carbon



# Index by part number

Part #	Page	Part #	Page	Part #	Page	Part #	Page	Part #	Page	Part #	Page	Part #	Page
1000C	1	1057C	3	1208H	5, 16, 43, 45	1307F	2, 45	189C	13	2011NSC	1	2011NSC	1
1000H	1	1057H	3	1209C	5	1308C	2	189F	13, 43, 45	2011NSJ	1	2011NSJ	1
1001C	1	1058C	3	1209H	5	1308F	2, 45	2000	10	20-12-0	38	20-12-0	38
1001H	1	1058H	3	120C	13	1309C	2	2000C	1	20120J	9	20120J	9
1002C	1	105C	13	120F	13, 43, 45	1309F	2, 45	2000H	1	20-12-13	38	20-12-13	38
1002H	1	105F	13	1210C	5, 16	1312C	2	2000NSC	1	20-12-2	38	20-12-2	38
1003H	1	1060C	2	1210H	5, 16, 43, 45	1312F	2	2000NSJ	1	20-12-6	38	20-12-6	38
1004C	1	1060H	2	1211	11	1313C	2	2001	10	20-12-9	38	20-12-9	38
1004H	1	1061C	2	1211C	5	1313F	2	2001C	1	2012C	1	2012C	1
1005H	1	1061H	2	1211H	5, 43, 45	1314C	2	2001H	1	2012H	1	2012H	1
1006C	1	1062C	2	1212B	5, 16	1314F	2, 45	2001NSC	1	2012NSC	1	2012NSC	1
1006H	1	1062H	2	1212C	5, 16	1318C	2	2001NSJ	1	2012NSJ	1	2012NSJ	1
1007C	1	1063C	2	1212H	5, 16, 43, 45	1318F	2	2002	10	2013	10	2013	10
1007H	1	1063H	2	1213B	5	1319C	2	2002B	1, 43, 45	2013C	1	2013C	1
1008C	1	1064C	2	1213C	5	1319F	2, 45	2002C	1	2013H	1	2013H	1
1008H	1	1064H	2	1213H	5	1320C	2	2002H	1, 43, 45	2013NSC	1	2013NSC	1
1009C	1	1065C	2	1214B	5	1320F	2	2002NSC	1	2014	10, 12	2014	10, 12
1009H	1	1066C	2	1214C	5	1324C	2	2002NSJ	1	2013NSJ	1	2013NSJ	1
100C	13	1067C	2	1214H	5	1324F	2, 45	2003C	1	2014B	1, 43, 45	2014B	1, 43, 45
100F	13, 43, 45	1068C	2	1216C	7	1325C	2	2003H	1	2014C	1, 43, 45	2014C	1, 43, 45
1010C	1	1068F	2	1216H	7	1325F	2	2003NSC	1	2014D	1	2014D	1
1010H	1	106C	13	1217	10	1330C	2	2003NSJ	1	2014H	1, 43, 45	2014H	1, 43, 45
1011C	1	106F	13, 43, 45	1217B	7, 43, 45	1330F	2, 45	2004C	1	2014NSC	1	2014NSC	1
1011H	1	1070C	2	1217C	7	1331C	2	2004H	1	2014NSF	1	2014NSF	1
1012C	1	1071C	2	1217H	7	1331F	2	2004NSC	1	2014NSJ	1	2014NSJ	1
1012H	1	1072C	2	1218C	5	1336C	2	2004NSJ	1	2015	10, 12	2015	10, 12
1013C	1	1073C	2	1218F	5	1336F	2	2005C	1	2015B	1, 43, 45	2015B	1, 43, 45
1013H	1	1073F	2	1218H	5	1337C	2	2005H	1	2015C	1	2015C	1
1014C	1	1074C	2	1219B	5, 43, 45	1337F	2	2005NSC	1	2015D	1	2015D	1
1014H	1	1074F	2	1219C	5	1342C	2	2005NSJ	1	2015F	1	2015F	1
1015C	1	1075C	2	1219F	5	1342F	2	2006	10	2015H	1, 43, 45	2015H	1, 43, 45
1015H	1	1076C	2	1219H	5	1343C	2	2006B	1, 43, 45	2015NSC	1	2015NSC	1
1016C	1	1077C	2	1220	10, 12	1343F	2	2006C	1	2015NSF	1	2015NSF	1
1016H	1	1077F	2	1220-1C	5	1349C	2	2006H	1, 43, 45	2015NSJ	1	2015NSJ	1
1017C	1	1078C	2	1220-1D	5	1349F	2	2006M	1	2016B	1, 43, 45	2016B	1, 43, 45
1017H	1	1078F	2	1220-1H	5	1350C	2	2006NSC	1	2016C	1	2016C	1
1019C	2	1079C	2	1220-2C	5	1350F	2	2006NSJ	1	2016D	1	2016D	1
1019H	2	107C	13	1220-2F	5	1351C	2	2007	10	2016F	1	2016F	1
1020C	2	107F	13, 43, 45	1220-2H	5, 43, 45	1351F	2	2007C	1	2016H	1, 43, 45	2016H	1, 43, 45
1020H	2	1080C	2	1220B	5, 43, 45	1352C	2	2007H	1, 43, 45	2016NSC	1	2016NSC	1
1021C	2	1080F	2	1220C	5	1352F	2	2007M	1	2016NSF	1	2016NSF	1
1021H	2	108C	13	1220D	5	1353C	2	2007NSC	1	2016NSJ	1	2016NSJ	1
1022C	2	108F	13, 43	1220F	5, 43, 45	1353F	2	2007NSJ	1	2017	10, 12	2017	10, 12
1022H	2	109C	13	1220H	43, 45	1354C	2	2008	10, 11, 12	2017B	1, 43, 45	2017B	1, 43, 45
1023C	2	109F	13, 45	1221B	5, 6, 43	1354F	2	2008B	1, 43, 45	2017C	1, 43	2017C	1, 43
1023H	2	1101C	3	1221C	5	1355C	2	2008C	1, 43, 45	2017D	1	2017D	1
1024C	2	1101H	3	1221H	5, 43, 45	1355F	2	2008F	1	2017F	1	2017F	1
1024H	2	1102C	3	1221F	5	1356C	2	2008H	1, 43, 45	2017H	1, 43, 45	2017H	1, 43, 45
1025C	2	1102H	3	1222C	6	1356F	2	2008M	1	2017NSC	1	2017NSC	1
1025H	2	1103C	3	1222F	6	1357C	2	2008NSC	1	2017NSF	1	2017NSF	1
1026C	2	1103H	3	1222H	6, 43, 45	1357F	2	2008NSF	1	2017NSJ	1	2017NSJ	1
1026H	2	1104C	3	1223C	6	140C	13	2008NSJ	1	2018B	1, 43, 45	2018B	1, 43, 45
1027C	2	1104H	3	1223F	6	140F	13, 43, 45	2009	10, 12	2018C	1	2018C	1
1027H	2	1105C	3	1223H	6, 43, 45	142C	13	2009B	1, 43, 45	2018F	1	2018F	1
1028C	2	1105H	3	1224C	6	142F	13, 43, 45	2009C	1, 43, 45	2018H	1, 43, 45	2018H	1, 43, 45
1028H	2	1106C	3	1224F	6	145C	13	2009D	1	2018NSC	1	2018NSC	1
1029C	2	1106H	3	1224H	6	145F	13, 43, 45	2009H	1, 43, 45	2019C	2	2019C	2
1029H	2	1107C	3	1225C	6	146C	13	2009NSC	1	2019H	2	2019H	2
102C	13	1107H	3	1225F	6	146F	13, 43, 45	2009NSF	1	201C	14	201C	14
102F	13, 43, 45	1108C	3	1225H	6	147C	13	2009NSJ	1	201H	14, 43, 45	201H	14, 43, 45
1030C	2	1108H	3	1229C	5	147F	13, 43, 45	20100J	9	2020C	2	2020C	2
1030H	2	1109C	5	1229F	5	148C	13	20101J	9	2020H	2	2020H	2
1031C	2	1109H	5, 43, 45	1229H	5	148F	13, 43, 45	20102J	9	2022C	2	2022C	2
1031H	2	1115C	5	122C	13	149C	13	20103J	9	2021C	2	2021C	2
1032C	2	1115H	5	122F	13, 43, 45	149F	13, 43, 45	20104J	9	2021H	2	2021H	2
1032H	2	1116	11	1230B	5, 43	160C	13	20105J	9	2022H	2	2022H	2
1033C	2	1116C	5	1230C	5	160F	13, 43, 45	20106J	9	2023C	2	2023C	2
1034C	2	1116H	5	1230F	5	162C	13	20107J	9	2023H	2	2023H	2
1035C	2	1117C	5	1230H	5, 43, 45	162F	13, 43, 45	20108J	9	2024C	2	2024C	2
1035H	2	1117H	5	1231C	5	165C	13	20109J	9	2024H	2	2024H	2
1036C	2	1119	11	1231H	5, 43, 45	165F	13, 43, 45	2010B	1, 43	2025C	2	2025C	2
1040B	5	1119C	7	1232H	16, 43, 45	166C	13	2010C	1	2025H	2	2025H	2
1041B	5	1119H	7	125C	13	166F	13, 43, 45	2010D	1	2026C	2	2026C	2
1043B	5	1200C	5	125F	13, 43	167C	13	2010H	1, 45	2026H	2	2026H	2
1044B	5	1200H	5	126C	13	167F	13, 43, 45	2010NSC	1	2027C	2	2027C	2
1048F	7	1201C	5	126F	13, 43, 45	168C	13	2010NSF	1	2027H	2	2027H	2
1048P	7	1201H	5	127C	13	168F	13, 43, 45	2010NSJ	1	2028C	2	2028C	2
1050C	3	1202C	5	127F	13, 43, 45	169C	13	2011	10, 12	2028H	2	2028H	2
1050H	3	1202H	5	128C	13	169F	13, 43, 45	20110J	9	2029C	2	2029C	2
1051C	3	1203H	5	128F	13, 43, 45	180C	13	20111J	9	2029J	2	2029J	2
1051H	3	1204B	6, 43, 45	129C	13	180F	13, 43, 45	20112J	9	202C	14	202C	14
1052C	3	1204H	6	129F	13, 43, 45	182C	13	20113J	9	202H	14, 43, 45	202H	14, 43, 45
1052H	3	1205B	6, 43, 45	1300C	2	182F	13, 43, 45	20114J	9	20300F	15, 43	20300F	15, 43
1053C	3	1205H	6	1300F	2, 45	185C	13	20115J	9	20301F	15, 43	20301F	15, 43
1053H	3	1206B	5	1303C	2	185F	13, 43, 45	20116J	9	20302F	15, 43	20302F	15, 43
1054C	3	1206C	5	1303F	2, 45	186C	13	20117J	9	20303F	15, 43	20303F	15, 43
1054H	3	1206H	5, 43, 45	1305C	2	186F	13, 43, 45	20118J	9	20304F	15, 43	20304F	15, 43
1055C	3	1207C	5	1305F	2, 45	187C	13	20119J	9	20305F	15, 43, 45	20305F	15, 43, 45
1055H	3	1207H	5, 43, 45	1306C	2	187F	13, 43, 45	2011C	1	20306F	15, 43, 45	20306F	15, 43, 45
1056C	3	1208B	5, 16	1306F	2	188C	13	2011D	1	20307F	15, 43, 45	20307F	15, 43, 45
1056H	3	1208C	5, 16	1307C	2	188F	13, 43, 45	2011H	1, 43, 45	20308F	15, 43, 45	20308F	15, 43, 45

wiring accessories master catalog rev704

# Index by part number

Part #	Page	Part #	Page	Part #	Page	Part #	Page	Part #	Page	Part #	Page
20309F	15, 43, 45	2057C	3	2104C	3	2124H	6, 43, 45	2303H	1	240H	39
2030C	2	2057H	3, 43, 45	2104H	3, 43, PB 45	2124NSC	6	2303J	1	2410E	15, 43, 45
2030J	2	2057NSC	3	2104NSC	4	2124NSJ	6	2303SF	1	2411E	15, 43, 45
20310F	15, 43, 45	2057NSJ	3	2104NSJ	4	2125	10, 12	2303SJ	1	2412E	15, 43, 45
20311F	43, 45	2058B	3, 43, 45	2105	10, 11, 12	2125C	6	2304SF	1	2413E	15, 43, 45
20312F	15, 43	2058C	3	2105B	3, 43, PB 45	2125H	6, 43, 45	2304SJ	1	2415E	15, 43, 45
20313F	15, 43, 45	2058H	3, 43, 45	2105C	3, 43, PB 45	2125NSC	6	2305SF	1	2418E	15, 43, 45
20314F	15, 43, 45	2058NSC	3	2105H	3, 43, PB 45	2125NSJ	6	2305SJ	1	2419E	15, 43, 45
20315F	15, 43	2058NSF	3	2105M	3	2127H	43, 45	2306H	1	241H	39, 43, 45
20316F	15, 43, 45	2058NSJ	3	2105NSC	4	2129B	7, 43	2306J	1	242	39
20317F	15, 43, 45	205C	14	2105NSF	4	2129H	7, 43, 45	2306SJ	1	2420E	15, 43, 45
20318F	15, 43, 45	205H	14, 43, 45	2105NSJ	4	212H	12	2307H	1	2421E	15, 43, 45
20319F	15, 43	2060	10, 11, 12	2106	10, 12	2131H	7, 43, 45	2307J	1	2424E	15
2031C	2	20-6-0	38	2106B	3, 43	213H	12, 43, 45	2307SF	1	2425E	15, 43, 45
2031J	2	2060B	2, 43, 45	2106C	3, 43	214710-1	37	2307SJ	1	2427E	15
20320F	15, 43	2060C	2, 43, 45	2106H	3, 43, 45	214711-1	37	2308H	1, 43	2428E	15
20321F	15, 43, 45	2060H	2, 43, 45	2106M	3	214712-1	37	2308J	1	242H	39, 43, 45
20322F	15, 43	2060M	2	2106NSC	4	214713-1	37	2308SF	1	2430E	15
20323F	15, 43	2061	10, 11, 12	2106NSF	4	214714-1	37	2308SJ	1	2431E	15, 43, 45
20324F	15, 43	20-6-13	38	2106NSJ	4	214715-1	37	2309H	1, 43	2432E	15
20325F	16, 43, 45	2061B	2, 43, 45	2107	10, 11, 12	214716-1	37	2309J	1	2433E	15, 43, 45
20326F	15, 43, 45	2061C	2, 43, 45	2107B	3, 43, 45	214717-1	37	2309SF	1	2434E	15, 43, 45
2032C	2	2061H	2, 45	2107C	3, 43	214718-1	37	2309SJ	1	2435E	15, 43, 45
2032J	2	2061M	2	2107D	3	214719-1	37	230F	40, 43, 45	2436E	15, 43, 45
2033C	2	2062	10, 11, 12	2107F	3	214721-1	37	2310H	1	2437E	15, 43, 45
2033J	2	20-6-2	38	2107H	3, 43, 45	214H	12, 43, 45	2310J	1	2440F	19
2034C	2	2062B	2, 43, 45	2107NSC	4	2150H	6	2310SF	1	2441F	19, 43
2034J	2	2062C	2, 43, 45	2107NSJ	4	215-1F	39	2310SJ	1	2442F	43
2035C	2	2062D	2	2108	10	2151H	6, 43, 45	2311H	1	2443F	19, 43
2035J	2	2062H	2, 43, 45	2108B	3, 43, 45	215-2F	39	2311J	1	2444F	19, 43
2036C	2	2063C	2	2108C	3	2152H	6	2311SF	1	2445F	19, 43
2036J	2	2063H	2	2108D	3	2153H	6, 43, 45	2311SJ	1	2446F	19, 44
203C	14	2064C	2	2108F	3	2155B	7, 43	2312H	1	244703-2	38
203H	14, 43, 45	2064H	2	2108H	3, 43, 45	2155H	43, 45	2312J	1	244705-2	38
204702-2	11	2065C	2	2108NSC	4	2156B	6	2313H	1	2447F	19, 44
204706-2	11	2065H	2, 43, 45	2108NSJ	4	2156H	6, 43, 45	2313J	1	245	39
204711-1	37	20-6-6	38	2109	11	2157H	6, 43, 45	2314H	1, 43	2450F	16, 44, 45
204711-2	37	2066B	2	2109B	5, 43	2158H	7, 43, 45	2314SF	1	2452F	16, 44, 45
204711-3	37	2066C	2, 43, 45	2109C	5	2159B	43	2314SJ	1	2457F	16, 44
204711C	37	2066H	2, 43, 45	2109D	5	2159H	43, 45	2315C	1	2458F	16, 44
204712-1	37	2066M	2	2109H	5, 43, 45	215H	39, 43, 45	2315H	1	2465F	16, 44, 45
204712-2	37	2067C	2	210H	12, 43, 45	21-6-0	38	2315J	1	2466F	16, 44, 45
204712-3	37	2067F	2	2110B	6, 43, 45	217-1F	39	2315SF	1	2467F	16, 44, 45
204712C	37	2067H	2, 43, 45	2110C	6	217-2F	39	2315SJ	1	2468F	16, 44, 45
204713-2	37	2068C	2	2110H	6, 43, 45	217F	39	2316H	1	2470F	16
204714-2	37	2068F	2	2110NSC	6	217H	39, 43	2316J	1	2475F	15, 44, 45
204C	14	20-6-9	38	2111	10, 12	21-8-0	38	2316SF	1	2476H	15, 44, 45
204H	14, 43, 45	2069C	2	2111B	6, 43, 45	218-1F	39	2316SJ	1	2477H	15, 44, 45
2050	10	2069F	2	2111C	6	218-2F	39	2317H	1	2478H	15, 44, 45
20503H	7	206H	43, 45	2111F	6	218F	39	2317J	1	2479F	17, 44, 45
20506C	7	2070C	2	2111H	6, 43, 45	218H	39, 43, 45	2317SF	1	2480F	17
20506H	7	2070H	43, 45	2111NSC	6	219F	43, 45	2317SJ	1	2490F	16
20507C	7	2071C	2	2111NSJ	6	2200H	8	2318C	1	2491F	17
20507H	7	2071H	43, 45	2112	10, 12	2203H	8	2318H	1	2500H	19, 44
2050C	3	2072	11	2112B	6, 43, 45	2205F	8	2318J	1	2502H	17, 44, 45
2050H	3	2072C	2	2112C	6	2205H	8	2318SF	1	2503H	17, 44, 45
2050NSC	3	2072H	43, 45	2112D	6	2206F	8	2318SJ	1	2504-1F	17, 44, 45
2050NSJ	3	207H	12, 43, 45	2112F	6	2206H	8	232F	40	2504-2F	17, 44, 45
2051	10	20-8-0	38	2112H	6, 43, 45	2208F	8	233F	40	2504H	17, 44, 45
2051C	3	20-8-13	38	2112NSC	6	2208H	8	234F	40	2505F	17, 44, 45
2051H	3	20-8-2	38	2112NSJ	6	220H	39, 43, 45	2352SF	3	2506F	17, 44, 45
2051NSC	3	2083H	4	2113C	3	2211F	8	2352SJ	3	2507-1F	17, 44, 45
2051NSJ	3	2085H	4	2113H	3, 43, 45	2211H	8	2355H	43	2507-2F	17, 44, 45
2052	10	20-8-6	38	2114H	43, 45	2214F	8	2355SF	3	2507-3F	17
2052C	3	20-8-9	38	2115C	4-53	2214H	8	2355SJ	3	2507F	44, 45
2052H	3, 43, 45	208H	12, 43, 45	2115H	43, 4-53	2216F	8	2358SF	3	2508-1F	17, 44, 45
2052NSC	3	2090H	4	2116	10, 12	2217F	8	2358SJ	3	2508-2F	17
2052NSJ	3	2091C	4	2116B	4	2219F	8	235F	40	2508-3F	18
2053B	3, 43, 45	2091H	4	2116C	4, 43, 45	221H	39, 43, 45	2362SF	4	2508F	17, 44, 45
2053C	3	2093H	4	2116D	4	2220F	8	2362SJ	4	2509F	18, 44, 45
2053H	3, 43, 45	209H	12, 43, 45	2116F	4	2222F	8	2363SF	4	2511F	18
2053NSC	3	2100C	3	2116H	4, 43, 45	2223F	8	2363SJ	4	2512F	18, 44, 45
2053NSJ	3	2100H	3	2117	10, 12	2225F	8	2365SF	4	2513F	18, 44, 45
2054	10, 11, 12	2101AH	3	2117B	4	2226F	8	2365SJ	4	2514F	18, 44, 45
2054C	3, 43, 45	2101C	3	2117C	4	2227F	8	2366SF	4	2515F	18, 44, 45
2054H	3, 43, 45	2101H	3	2117D	4	2228F	8	2366SJ	4	2516F	18, 44, 45
2054M	3	2101NSJ	4	2117F	4	222C	13	2367SF	4	2517F	18, 44, 45
2054NSC	3	2102	10	2117H	4, 43, 45	222F	13, 43, 45	2367SJ	4	2518F	18
2054NSJ	3	2102C	3	2118C	4	225F	39, 43, 45	2368SF	4	2520	11
2055	10, 12	2102H	3, 43, 45	2118H	4, 43, 45	226	11	2368SJ	4	2520F	11
2055B	3, 43, 45	2102M	3	2119C	4	226F	39	2370SF	2	2521	11
2055C	3, 43	2102NSC	4	2119H	4, 43, 45	2300H	1	2370SJ	2	2521F	7
2055H	3, 43, 45	2102NSJ	4	211H	12	2300SF	1	2371SF	2	2522F	18, 44, 45
2055M	3	2103	10	2120H	7, 43, 45	2300SJ	1	2371SJ	2	2523F	18, 44, 45
2055NSC	3	2103C	3	2121B	7, 43, 45	2301H	1	2372SF	2	2524F	16
2055NSF	3	2103H	3, 43, PB 45	2121H	7, 43, 45	2301J	1	2372SJ	2	2525F	19, 44, 46
2055NSJ	3	2103NSC	4	2122H	7, 43, 45	2301SF	1	2375H	43	2526H	16, 44, 46
2056C	3	2103NSJ	4	2123H	43, 45	2301SJ	1	2376H	43	2527H	16, 44, 46
2056H	3	2104AC	3	2123NSC	6	2302H	1, 43	2406E	15, 43, 45	2528H	16, 44, 46
2056NSC	3	2104AH	3	2124	10, 12	2302J	1	2408E	15, 43, 45	2529H	16, 44, 46
2056NSJ	3	2104B	3	2124C	6	2302SF	1	2409E	15, 43, 45	2530H	19, 44

# Index by part number

Part #	Page	Part #	Page	Part #	Page	Part #	Page	Part #	Page	Part #	Page
253-1F	39	2609J	29	2819F	25, 44	3125	13	4200C	36	4309C	36
2531H	19, 44	2610H	44, 46	2820F	25, 44	3126	13	4200T-4F	52	4310-150	36
253-2F	39	2612J	29, 44, 46	2821F	25, 44	3129	13	4200T-6F	52	4312C	36
2532H	19	2615J	29, 44, 46	2822F	25, 44	3140	13	4200T-8F	52	4400C	36
2533H	19, 44	2616J	29, 44, 46	2823F	44	3142	13	4201-200-0	35	4400H	36
2534F	19	2617J	29, 44, 46	2824F	25, 44	3145	13	4201C	36	4401C	36
2535F	19, 44	2618F	29	2825F	25, 44	3146	13	4202-125-0	35	4401H	36
2536J	20	2620F	29, 44, 46	2826F	26, 44	3149	13	4203-100-0	35	4402C	36
2537H	20, 44	2622J	29, 44, 46	2827F	26, 44	3160	13	4203C	36	4402H	36, 44, 46
2538H	20	2625J	29	2828F	26, 44	3162	13	4204-100-0	35	4403C	36
2539H	20, 44	2626J	29, 44, 46	2829F	26, 44	3165	13	4204C	36	4403H	36
253F	39, 44, 46	2630F	29, 44, 46	2830F	26, 44	3166	13	4205-75-0	35	4404C	36
2540H	20, 44	2632H	30, 44, 46	2831F	26, 44	3169	13	4205C	36	4404H	36
254-1F	39	2633F	30	2832F	26, 44	3180	13	4206-50-0	35	4405C	36
2541H	20, 44	2635H	30, 44, 46	2833F	26, 44	3182	13	4206C	36	4405H	36, 44, 46
254-2F	39	2636H	44, 46	2834F	26, 44	3185	13	4207-40-0	35	4406C	36
2542H	20, 44	2637H	30, 44, 46	2835F	26, 44	3186	13	4207C	36	4406H	36
2543F	20	2640H	29, 44, 46	2836F	26, 44	3189	13	4208-30-0	35	4407C	36
2544F	20	2641F	29, 44, 46	2837F	26, 44	3850	9	4209-50-0	35	4407H	36
2545F	20	2642F	29, 44, 46	2838F	44	3853	9	4210-0F	52	4408C	36
2546J	20	2643F	29, 44, 46	2839F	26, 44	3855	9	4210-17F	52	4408H	36, 44, 46
2547H	20, 44	2644F	29, 44, 46	2840F	26, 44	4000	32	4210-1F	52	4409C	36
2548H	20, 44	2645F	29	2841F	26, 44	4000H	32	4210-50-0	35	4409H	36
254F	39, 44, 46	2646F	29	2851F	9	4001	32	4210F	52	4450H	36, 44, 46
2550F	20, 44	264705-2	38	2853F	9	4001H	32	4211-0F	52	4451H	36
2551F	20, 44	264705-8	38	2854F	9	4002	32	4211-17F	52	4452H	36, 44, 46
2552H	20	2647F	29	2856F	9	4002H	32	4211-2F	52	4453H	36, 44, 46
2553F	21	2648F	29, 44	2857F	9	4003	32	4211-50-0	35	4464	39
2554F	21	2649F	29	2865F	44	4003H	32	4211-6F	52	4464F	39
2554F	44	2650E	31, 44, 46	2866F	9, 44	4004	32	4211F	52	4466	39
2555F	21	2651E	31, 44, 46	2867F	9, 44	4004-4	11	4212-0F	52	4466F	39, 44, 46
2556-1H	21, 44	2652-5F	31	2868F	9, 44	4004H	32, 44, 46	4212-11F	52	4468	39
2556H	21, 44	2652-7F	31	2869F	44	4005	32	4212-13F	52	4468F	39, 44, 46
2557-1H	21, 44	2652F	31, 51	2870F	26, 44	4005-4	11	4212-15F	52	4470	39
2557-2H	21, 44	2653-1J	31, 51	2871F	27, 44	4005H	32, 44, 46	4212-17F	52	4470F	39, 44, 46
2557H	21, 44	2653J	29, 44, 46	2872F	27, 44	4006	32	4212F	52	4472	39
2558H	21, 44	2654J	29	2873F	27, 44	4006-4	11	4215-225-0	35	4472F	39, 44, 46
2559H	21, 44	2655F	29	2874F	27, 44	4006H	32, 44, 46	4215F	52	4474	39
2560F	18, 44	2656F	29	2878F	27, 44	4007	32	4216-200-0	35	4474F	39
2561H	21, 44	2657F	29	2880F	27	4007H	32	4216F	52	4476	39
2562H	21, 44	2658F	29	2882F	27, 44	4008	32	4217-125-0	35	4476F	39, 44, 46
2563H	21, 44	2659F	31, 44, 46	2883F	27, 44	4008H	32	4218-100-0	35	4478	39
2564H	21, 44	2670F	30, 44, 46	2884F	27, 44	4009	32	4220-75-0	35	4484	39
2565F	21	2672F	30, 44, 46	2885F	27, 44	4009H	32	4220F	52	4484F	39
2565H	21, 44	2673F	30, 44, 46	2886F	27, 44	4010	32	4221-50-0	35	4490F	39, 44, 46
2566F	22, 44	2675H	31, 44, 46	2888F	27, 44	4011	32	4221F	52	4495F	39
2567F	22, 44	2676F	30, 44, 46	2889F	27, 44	4012	32	4222-30-0	35	4600C	38
2568F	22	2677F	30, 44, 46	2890F	27, 44	4013	32	4222F	34	4600H	38
2568H	44	2680F	30, 44, 46	2891F	27, 44	4014	32	4223-50-0	35	4600H-0	38
2569F	22	2681F	30, 44, 46	2892F	28, 44	4030	34	4225-50-0	35	4601C	38
2570F	22	2683F	30, 44, 46	2893F	28, 44	4030F	34	4230-100-0	35	4601H	38
2570H	44	2689-1F	30, 44, 46	2894F	28, 44	4030J	34	4231-100-0	35	4601H-0	38
2571F	22	2689F	30, 44, 46	2895F	28, 44	4031	34	4232-100-0	35	4602C	38
2572F	22	2690F	30, 44, 46	2896F	28, 44	4031F	34	4233-100-0	35	4602H	38, 44, 46
2573F	22, 44	2691F	30, 44, 46	2897F	28, 44	4031J	34	4234-75-0	35	4602H-0	38
2574F	22	2694F	30	2898F	28, 44	4032	34	4235-50-0	35	4603C	38
2575F	22	2695F	30, 44, 46	2899-1F	28, 44	4032F	34	4236-50-0	35	4603H	38, 44, 46
2576H	22	2700-2J	31, 51	2899F	28, 44	4032J	34	4237-50-0	35	4603H-0	38
2577F	22	2700-4J	31, 51	2900F	29	4033	34	4250-12-0	35	4604C	38
2578F	22, 44	2700-5J	31, 51	2902F	29, 44	4033F	34	4250-12-10	35	4604H	38, 44, 46
2580F	22, 44	2700-6J	31, 51	2905F	29, 44	4033J	34	4250-12-8	35	4604H-0	38
2581F	22	2700J	31, 51	2906F	29, 44	4034	34	4250F	36	4605C	38
2582F	23	2701-2J	31, 51	2907F	29, 44	4034F	34	4251F	36	4605H	38
2583F	23, 44	2701-4J	31, 51	2910F	29, 44	4034J	34	4270	36	4605H-0	38
2584F	23, 44	2701-5J	31, 51	2913F	29	4035	34	4271	36	4606C	38
2585H	23	2701-6F	31	2918F	29	4035F	34	4272	36	4606H	38, 44, 46
2586F	23	2702-2J	31, 51	2941F	29	4035J	34	4273	36	4606H-0	38
2587F	23, 44	2702-4J	31, 51	2950F	31	4051H	32, 44, 46	4274	36	4607C	38
2588-1F	23, 44	2702-5J	31, 51	2951F	31	4052H	32	4275	36	4607H	38
2588-2F	23, 44	2703-2J	31, 51	2952F	31	4053H	32, 44, 46	4304-3F	36	4607H-0	38
2588-3F	44	2703-4J	31, 51	2953F	31	4054H	32	4304-6F	36	4608C	38
2588F	23, 44	2703-5J	31, 51	2954F	31	4055H	32	4304-9C	36	4608H	38
2589F	23	2800F	24, 44	2955F	31	4056H	32	4304-9F	36	4608H-0	38
2590H	23, 44	2801F	24, 44	2965F	30	4057H	32	4304C	36	4609C	38
2591F	23, 44	2802F	24, 44	2966F	30	4058H	32	4304F	36, 44, 46	4609H	38
2592F	23, 44	2803F	24, 44	2967F	30	4059H	32	4305-9C	36	4609H-0	38
2593F	23, 44	2804F	24, 44	2980F	30	4060H	32	4305-9F	36	4610C	38
2594F	23	2805F	24, 44	2986F	30	4101-0	35	4305C	36	4610H	38
2595F	24	2806F	24, 44	304703-1	38	4102-0	35	4305F	36, 44, 46	4610H-0	38
2596H	24	2807F	24, 44	304705-1	38	4103-0	35	4306-9C	36	4611C	38
2597H	24, 44	2808F	24, 44	304709-1	38	4104-0	35	4306-9F	36	4611H	38
2598H	24, 44	2809F	24, 44	3100	13	4105-0	35	4306C	36	4611H-0	38
2599F	24, 44	2810F	24, 44	3100-10	11	4106-0	35	4306F	36, 44, 46	4612C	38
2600J	29, 44, 46	2811F	25, 44	3102	13	4107-0	35	4307-9C	36	4612H	38
2602J	29, 44, 46	2812F	25, 44	3102-10	11	4108-0	35	4307-9F	36	4612H-0	38
2603F	30, 44	2813F	25, 44	3105	13	4109-0	35	4307C	36	4613C	38
2604F	30, 44	2814F	25, 44	3106	13	4110-0	35	4307F	36, 44, 46	4613H	38
2605J	29, 44, 46	2815F	25, 44	3109	13	4111-0	35	4308-9C	36	4613H-0	38
2606J	29, 44, 46	2816F	25, 44	3109-10	11	4112-0	35	4308-9F	36	4650H	38, 44, 46
2607J	29, 44, 46	2817F	25, 44	3120	13	4125-0	35	4308C	36	4651H	38
2609F	44	2818F	25, 44	3122	13	4200-225-0	35	4308F	36	4652H	38

wiring accessories master catalog rev704

Part #	Page	Part #	Page	Part #	Page	Part #	Page	Part #	Page	Part #	Page
4653H	38	4705N8H	37	4810H	41	73F	6	J-8502	33	J-8816	33
4654H	38, 44, 46	4705N8M	37	4811	41	73H	6, 44, 46	J-8503	33	J-8817	33
4701-2C	37	4706C	37, 44, 46	4811H	41	74	10	J-8504	33	J-8818	33
4701-2H	37, 44	4706H	37, 44, 46	4812	41	74B	6, 44, 46	J-8505	33	J-8819	33
4701-2M	37	4706M	37	4812H	41	74C	6	J-8506	33	J-8821	33
4701-4C	37	4707-2C	37	4813	41	74F	6	J-8507	33	J-8822	33
4701-4H	37	4707-2H	37, 44	4813H	41	74H	6	J-8508	33	J-8823	33
4701-4M	37	4707-4C	37	4816	41	76	10	J-8509	33	J-8824	33
4701-5C	37	4707-4H	37	4816H	41	76C	6	J-8510	33	J-8825	33
4701-5H	37	4707-5C	37	4817	41	76F	6	J-8511	33	J-8826	33
4701-5M	37	4707-5H	37	4817H	41	76H	6	J-8512	33	J-8827	33
4701-6C	37	4707-6C	37	4818	41	7785F	42, 44	J-8513	33	J-8828	33
4701-6H	37, 44	4707-6H	37, 44	4818H	41	7786F	42, 44	J-8514	33	J-8829	33
4701-6M	37	4707-7C	37	4819	41	7900F	42, 44, 46	J-8515	33	J-8831	33
4701-7C	37	4707-7H	37, 44	4819H	41	7902F	42	J-8516	33	J-8832	33
4701-7H	37, 44	4707-8H	37	4822	41	7905F	42, 44, 46	J-8517	33	J-8833	33
4701-7M	37	4707C	37, 44, 46	4822H	41	7910F	42, 44	J-8518	33	J-8834	33
4701-8C	37	4707D	37	4823	41	7915F	44	J-8519	33	J-8835	33
4701-8H	37	4707H	37, 44, 46	4823H	41	7925F	42	J-8520	33	J-8836	33
4701-8M	37	4707N3H	37	4824	41	7926F	42	J-8521	33	J-8837	33
4701C	37, 44, 46	4707N5H	37	4824H	41	7930F	42, 44	J-8522	33	J-8838	33
4701H	37, 44, 46	4707N7H	37	4825	41	7931F	42, 44	J-8523	33	J-8839	33
4701M	37	4707N8H	37	4825H	41	80001	11	J-8524	33	J-8841	33
4701N3C	37	4708C	37, 44, 46	4826	41	80C	13	J-8525	33	J-8842	33
4701N3H	37	4708D	37	4826H	41	8101F	13	J-8526	33	J-8843	33
4701N3M	37	4708H	37, 44, 46	4830H	41	82C	13	J-8527	33	J-8844	33
4701N5C	37	4709-2C	37	4831	41	91000C	4	J-8528	33	J-8845	33
4701N5H	37	4709-4C	37	4831H	41	91000H	4	J-8529	33	J-8846	33
4701N5M	37	4709-5C	37	4832	41	91001C	4	J-8530	33	J-8847	33
4701N7C	37	4709-6C	37	4832H	41	91002C	4	J-8531	33	J-8848	33
4701N7H	37	4709-7C	37	4833	41	91002H	4	J-8532	33	J-8849	33
4701N7M	37	4709C	37	4833H	41	91003C	4	J-8533	33	J-8851	33
4701N8C	37	4709D	37	4834	41	91005C	4	J-8534	33	J-8852	33
4701N8H	37	4709H	37	4834H	41	91006C	4	J-8535	33	J-8853	33
4701N8M	37	4710C	37	4836	41	91006H	4	J-8536	33	J-8854	33
4702C	37, 44, 46	4710D	37	4836H	41	91007C	4	J-8537	33	J-8855	33
4702H	37, 44, 46	4710H	37	4837	41	91008C	4	J-8538	33	J-8856	33
4702M	37	4711C	37	5000F	9, 40	91008H	4	J-8539	33	J-8857	33
4703-2C	37	4711H	37	5002	10	91009C	4	J-8540	33	J-8858	33
4703-2H	37, 44	4712C	37	5002F	40, 44, 46	91009H	4	J-8541	33	J-8859	33
4703-2M	37	4712H	37	5003F	40, 44, 46	91011C	4	J-8542	33	J-8881	33
4703-4C	37	4714F	37	5008F	40, 44, 46	91012C	4	J-8543	33	J-8882	33
4703-4H	37	4716F	37	5010F	40	91013C	4	J-8544	33	J-8883	33
4703-4M	37	4724C	37	5011F	40	91014C	4	J-8545	33	J-8884	33
4703-5C	37	4724D	37	5012F	9	91014H	4	J-8546	33	J-8885	33
4703-5H	37	4724H	37	5013F	9	91015C	4	J-8547	33	J-8886	33
4703-5M	37	4725C	37	5014F	9	91015H	4	J-8548	33	J-8887	33
4703-6C	37	4725D	37	5020F	40	91017C	4	J-8549	33	J-8888	33
4703-6H	37, 44	4725H	37	514115-0-8	35	91052C	4	J-8550	33	J-8889	33
4703-6M	37	4726C	37	514115-1-8	35	91055C	4	J-8551	33	X204701-2	12
4703-7C	37	4726D	37	514115-8-8	35	91058C	4	J-8552	33	X204701-2-11	12
4703-7H	37, 44	4726F	37	519F	28	91060C	4	J-8553	33	X204701-2-13	12
4703-7M	37	4726H	37	519H	28	91061C	4	J-8554	33	X204701-2-14	12
4703-8C	37	4727C	37	5304-2F	35, 51	91062C	4	J-8555	33	X204701-2-6	12
4703-8H	37	4727D	37	5304-4F	35, 51	91104H	4	J-8556	33	X204701-2-7	12
4703-8M	37	4727F	37	5304-6F	35, 51	91105C	4	J-8557	33	X204701-4	12
4703C	37, 44, 46	4727H	37	5305-2F	35, 51	91105H	4	J-8558	33	X204701-4-11	12
4703H	37, 44, 46	4728C	37	5305-4F	35, 51	91107C	4	J-8559	33	X204701-4-14	12
4703M	37	4728F	37	5305-6F	35, 51	91107H	4	J-8560	33	X204701-4-6	12
4704C	37, 44, 46	4728H	37	5306-2F	35, 51	91116C	4	J-8581	33	X204702-2	12
4704H	37, 44, 46	4730C	37	5306-4F	35, 51	91116H	4	J-8582	33	X204703-2	12
4704M	37	4730H	37	5306-6F	35, 51	91117C	4	J-8583	33	X204703-4	12
4705-2C	37	4735H	44, 46	5307-2F	35, 51	J-1001	34	J-8584	33	X204704-2	12
4705-2H	37, 44	4750H	38, 44, 46	5307-4F	35, 51	J-1002	34	J-8585	33	X204705-2	12
4705-2M	37	4751H	38	5307-6F	51	J-1003	34	J-8586	33	X204705-4	12
4705-4C	37	4752H	38	6000	11	J-1004	34	J-8587	33	X204705-4-2	12
4705-4H	37	4753H	38	6003	11	J-1005	34	J-8588	33	X204705-4-4	12
4705-4M	37	4754H	38, 44, 46	6005	10, 11	J-1006	34	J-8589	33	X204705-4-6	12
4705-5C	37	4755F	38, 44, 46	6006	11	J-1007	34	J-8590	33	X204705-4-7	12
4705-5H	37	4790F	12, 38	62-5021	37	J-1008	34	J-8710	34	X204706-2	12
4705-5M	37	4791F	12, 38	62-5022	37	J-1009	34	J-8711	34	X204706-4	12
4705-6C	37	4792F	12, 38	62-5023	38	J-1010	34	J-8712	34	X204707-3	12
4705-6H	37, 44	4794F	12	6800F	46	J-1011	34	J-8713	34	X204708-3	12
4705-6M	37	4796F	10, 51	6966F	11	J-1012	34	J-8714	34	X304705-1	12
4705-7C	37	4798F	38	6967F	11	J-1013	34	J-8715	34		
4705-7H	37, 44	4799F	38	6982F	10, 44, 46	J-1014	34	J-8716	34		
4705-7M	37	4800C	41	6985F	10	J-1015	34	J-8717	34		
4705-8H	37	4800H	41	6986F	10	J-1016	34	J-8801	33		
4705C	37, 44, 46	4801C	41	6989F	12	J-1017	34	J-8802	33		
4705H	37, 44, 46	4802C	41	6990F	10	J-1018	34	J-8803	33		
4705M	37	4802H	41	6991F	10, 44, 46	J-1019	34	J-8804	33		
4705N3C	37	4803C	41	6992F	44, 46	J-1020	34	J-8805	33		
4705N3H	37	4803H	41	71	10	J-1041	34	J-8806	33		
4705N3M	37	4804C	41	71C	6	J-1042	34	J-8807	33		
4705N5C	37	4804H	41	71H	6, 44, 46	J-1043	34	J-8808	33		
4705N5H	37	4805F	41	72	10, 11	J-1044	34	J-8809	33		
4705N5M	37	4805F-1	41, 51	72C	6	J-1045	34	J-8811	33		
4705N7C	37	4805H	41, 44, 46	72F	6	J-1046	34	J-8812	33		
4705N7H	37	4806C	41	72H	6, 44, 46	J-1047	34	J-8813	33		
4705N7M	37	4806H	41	73	10, 11	J-1048	34	J-8814	33		
4705N8C	37	4810	41	73C	6	J-8501	33	J-8815	33		



Ordering is easy!  
Electronic Data Interchange  
Phone, Fax, Email

# New Products for '06!!!



## 6935F Ultimate Installer's Box

Over 2500 must-have pieces  
Durable case with slide-out drawers  
Complete terminal assortment  
One drawer for each terminal size  
Heat shrink, wire clamps and grommets  
UV Black, natural, and stainless wire ties



## Technician's Pocket Torches

Perfect for heat shrink and heat shrink terminals, etc.

5021F Angled Head  
5022F Straight Head



## Smart Glow Fuses

Easily identify blown Fuses - "They Glow when They Blow"  
Full range of ATC, Mini, and Maxi fuses available



## Flex Guard Mini-Spools

JT&T #	QTY.	DESCRIPTION
4307-10F	10 Ft	FLEX GUARD SPLIT LOOM - BLACK - 3/4"
4307-14F	14 Ft	FLEX GUARD SPLIT LOOM - BLACK - 3/4"
4307-25F	25 Ft	FLEX GUARD SPLIT LOOM - BLACK - 3/4"
4308-10F	10 Ft	FLEX GUARD SPLIT LOOM - BLACK - 1"
4308-14F	14 Ft	FLEX GUARD SPLIT LOOM - BLACK - 1"
4308-25F	25 Ft	FLEX GUARD SPLIT LOOM - BLACK - 1"



## Pin Terminals

JT&T #	QTY.	DESCRIPTION
2290C	100 Pcs	22-18 AWG VINYL INSULATED PIN TERMINAL
2290H	14 Pcs	22-18 AWG VINYL INSULATED PIN TERMINAL
2290M	1000 Pcs	22-18 AWG VINYL INSULATED PIN TERMINAL
2291C	100 Pcs	16-14 AWG VINYL INSULATED PIN TERMINAL
2291H	12 Pcs	16-14 AWG VINYL INSULATED PIN TERMINAL
2291M	1000 Pcs	16-14 AWG VINYL INSULATED PIN TERMINAL
2292C	100 Pcs	12-10 AWG VINYL INSULATED PIN TERMINAL
2292H	8 Pcs	12-10 AWG VINYL INSULATED PIN TERMINAL
2292M	1000 Pcs	12-10 AWG VINYL INSULATED PIN TERMINAL



## Three-Way Connectors

JT&T #	QTY.	DESCRIPTION
2165C	100 Pcs	22-18 AWG VINYL INSULATED THREE-WAY CONNECTOR
2165H	5 Pcs	22-18 AWG VINYL INSULATED THREE-WAY CONNECTOR
2165M	1000 Pcs	22-18 AWG VINYL INSULATED THREE-WAY CONNECTOR
2166C	100 Pcs	16-14 AWG VINYL INSULATED THREE-WAY CONNECTOR
2166H	5 Pcs	16-14 AWG VINYL INSULATED THREE-WAY CONNECTOR
2166M	1000 Pcs	16-14 AWG VINYL INSULATED THREE-WAY CONNECTOR
2167C	100 Pcs	12-10 AWG VINYL INSULATED THREE-WAY CONNECTOR
2167H	3 Pcs	12-10 AWG VINYL INSULATED THREE-WAY CONNECTOR
2167M	1000 Pcs	12-10 AWG VINYL INSULATED THREE-WAY CONNECTOR
2175C	100 Pcs	22-18 AWG NYLON INSULATED THREE-WAY CONNECTOR
2175H	5 Pcs	22-18 AWG NYLON INSULATED THREE-WAY CONNECTOR
2175M	1000 Pcs	22-18 AWG NYLON INSULATED THREE-WAY CONNECTOR
2176C	100 Pcs	16-14 AWG NYLON INSULATED THREE-WAY CONNECTOR
2176H	5 Pcs	16-14 AWG NYLON INSULATED THREE-WAY CONNECTOR
2176M	1000 Pcs	16-14 AWG NYLON INSULATED THREE-WAY CONNECTOR
2177C	100 Pcs	12-10 AWG NYLON INSULATED THREE-WAY CONNECTOR
2177H	3 Pcs	12-10 AWG NYLON INSULATED THREE-WAY CONNECTOR
2177M	1000 Pcs	12-10 AWG NYLON INSULATED THREE-WAY CONNECTOR
2185C	100 Pcs	22-18 AWG HEAT SHRINK THREE-WAY CONNECTOR
2185H	2 Pcs	22-18 AWG HEAT SHRINK THREE-WAY CONNECTOR
2185M	1000 Pcs	22-18 AWG HEAT SHRINK THREE-WAY CONNECTOR
2186C	100 Pcs	16-14 AWG HEAT SHRINK THREE-WAY CONNECTOR
2186H	2 Pcs	16-14 AWG HEAT SHRINK THREE-WAY CONNECTOR
2186M	1000 Pcs	16-14 AWG HEAT SHRINK THREE-WAY CONNECTOR
2187C	100 Pcs	12-10 AWG HEAT SHRINK THREE-WAY CONNECTOR
2187H	2 Pcs	12-10 AWG HEAT SHRINK THREE-WAY CONNECTOR
2187M	1000 Pcs	12-10 AWG HEAT SHRINK THREE-WAY CONNECTOR



## Three-Way Connectors

JT&T #	QTY.	DESCRIPTION
2265C	100 Pcs	22-18 AWG VINYL INSULATED FOUR-WAY CONNECTOR
2265H	3 Pcs	22-18 AWG VINYL INSULATED FOUR-WAY CONNECTOR
2265M	1000 Pcs	22-18 AWG VINYL INSULATED FOUR-WAY CONNECTOR
2266C	100 Pcs	16-14 AWG VINYL INSULATED FOUR-WAY CONNECTOR
2266H	4 Pcs	16-14 AWG VINYL INSULATED FOUR-WAY CONNECTOR
2266M	1000 Pcs	16-14 AWG VINYL INSULATED FOUR-WAY CONNECTOR
2267C	100 Pcs	12-10 AWG VINYL INSULATED FOUR-WAY CONNECTOR
2267H	2 Pcs	12-10 AWG VINYL INSULATED FOUR-WAY CONNECTOR
2267M	1000 Pcs	12-10 AWG VINYL INSULATED FOUR-WAY CONNECTOR
2275C	100 Pcs	22-18 AWG NYLON INSULATED FOUR-WAY CONNECTOR
2275H	4 Pcs	22-18 AWG NYLON INSULATED FOUR-WAY CONNECTOR
2275M	1000 Pcs	22-18 AWG NYLON INSULATED FOUR-WAY CONNECTOR
2276C	100 Pcs	16-14 AWG NYLON INSULATED FOUR-WAY CONNECTOR
2276H	4 Pcs	16-14 AWG NYLON INSULATED FOUR-WAY CONNECTOR
2276M	1000 Pcs	16-14 AWG NYLON INSULATED FOUR-WAY CONNECTOR
2277C	100 Pcs	12-10 AWG NYLON INSULATED FOUR-WAY CONNECTOR
2277H	2 Pcs	12-10 AWG NYLON INSULATED FOUR-WAY CONNECTOR
2277M	1000 Pcs	12-10 AWG NYLON INSULATED FOUR-WAY CONNECTOR
2285C	100 Pcs	22-18 AWG HEAT SHRINK FOUR-WAY CONNECTOR
2285H	1 Pc	22-18 AWG HEAT SHRINK FOUR-WAY CONNECTOR
2285M	1000 Pcs	22-18 AWG HEAT SHRINK FOUR-WAY CONNECTOR
2286C	100 Pcs	16-14 AWG HEAT SHRINK FOUR-WAY CONNECTOR
2286H	1 Pc	16-14 AWG HEAT SHRINK FOUR-WAY CONNECTOR
2286M	1000 Pcs	16-14 AWG HEAT SHRINK FOUR-WAY CONNECTOR
2287C	100 Pcs	12-10 AWG HEAT SHRINK FOUR-WAY CONNECTOR
2287H	1 Pc	12-10 AWG HEAT SHRINK FOUR-WAY CONNECTOR
2287M	1000 Pcs	12-10 AWG HEAT SHRINK FOUR-WAY CONNECTOR



## Nylon Insulated Flag Terminals

JT&T #	QTY.	DESCRIPTION
2293C	100 Pcs	22-18 AWG NYLON INSULATED FLAG DISCONNECT
2293H	8 Pcs	22-18 AWG NYLON INSULATED FLAG DISCONNECT
2293M	1000 Pcs	22-18 AWG NYLON INSULATED FLAG DISCONNECT
2294C	100 Pcs	16-14 AWG NYLON INSULATED FLAG DISCONNECT
2294H	8 Pcs	16-14 AWG NYLON INSULATED FLAG DISCONNECT
2294M	1000 Pcs	16-14 AWG NYLON INSULATED FLAG DISCONNECT
2295C	100 Pcs	12-10 AWG NYLON INSULATED FLAG DISCONNECT
2295H	4 Pcs	12-10 AWG NYLON INSULATED FLAG DISCONNECT
2295M	1000 Pcs	12-10 AWG NYLON INSULATED FLAG DISCONNECT

# Introducing the Ultimate Installer Box

With over 2500 pieces, every commonly used wiring accessory is in one easy to use, easy to access box.

Our durable box uses Infinite Divider System organizer drawers for unlimited customization. The drawers are set up at the factory and ready to go. But, if you decide down the road you want to reorganize a little, you have infinite adjustability. Not only can you move the dividers anywhere within each row, but we also supply the case with extra dividers so you can customize the drawers as you see fit.

Our rugged case not only organizes and protects each drawer, but its durable plastic shell is designed for stacking – the interlocking design means you can stack multiple cases, and never worry about them sliding around.

Have a project at the other end of the building? Just pull the drawer you need out and carry it with you. Durable integrated handles and latches mean you can just pull the drawer out and go. Your terminals won't jump into other sections, and you won't need to keep going back to the box for more.



- Each size of terminals has its own drawer for complete organization.
- Each drawer can be removed from the box for at-job access.
- Five drawers, five slide-out shelves, one heavy-duty box.
- Backed by the Number One name in wiring accessories.

No other wiring accessories box offers the comprehensive assortment, ease of access, organization and customization. No other wiring accessories box can compete.

## This is the Ultimate Installer Box.



JTT #	QTY.	DESCRIPTION	JTT #	QTY.	DESCRIPTION	JTT #	QTY.	DESCRIPTION
1216	50 Pcs	22-14 AWG Nylon Closed End Connect	2066	100 Pcs	16-14 AWG Nylon Insul Butt Connectors	4058	25 Pcs	Heat Shrink Tubing 4" Cut - Rainbow - 1/4"
1217	25 Pcs	12-10 AWG Nylon Closed End Connect	2070	15 Pcs	22-18 AWG Heat Shrink Butt Connectors	4059	10 Pcs	Heat Shrink Tubing 4" Cut - Rainbow - 3/8"
1219	15 Pcs	12-10 AWG Tap Splice Connectors w/Stop Yellow	2071	15 Pcs	16-14 AWG Heat Shrink Butt Connectors	4402	25 Pcs	Vinyl Grommets - 3/8"
1220	25 Pcs	18-14 AWG Tap Splice Connectors w/Stop Blue	2072	15 Pcs	12-10 AWG Heat Shrink Butt Connectors	4405	25 Pcs	Vinyl Grommets - 5/8"
2001	50 Pcs	22-18 AWG #8 Stud Vinyl Ring	2102	100 Pcs	22-18 AWG .250 Tab Vinyl FM Disconnect	4408	15 Pcs	Vinyl Grommets - 1"
2002	50 Pcs	22-18 AWG #10 Stud Vinyl Ring	2103	50 Pcs	22-18 AWG .250 Tab Vinyl M Disconnect	4604	15 Pcs	Nylon Cable Clamps - Natural - 3/8"
2007	50 Pcs	16-14 AWG #8 Stud Vinyl Ring	2105	100 Pcs	16-14 AWG .250 Tab Vinyl FM Disconnect	4606	10 Pcs	Nylon Cable Clamps - Natural - 1/2"
2008	50 Pcs	16-14 AWG #10 Stud Vinyl Ring	2106	50 Pcs	16-14 AWG .250 Tab Vinyl M Disconnect	4701	100 Pcs	4" Nylon Wire Ties 18 Lbs Natural
2014	25 Pcs	12-10 AWG #10 Stud Vinyl Ring	2107	50 Pcs	12-10 AWG .250 Tab Vinyl FM Disconnect	4702	100 Pcs	4" Nylon Wire Ties 18 Lbs UV Black
2015	25 Pcs	12-10 AWG 1/4" Stud Vinyl Ring	2108	25 Pcs	12-10 AWG .250 Tab Vinyl M Disconnect	4705	50 Pcs	7.5" Nylon Wire Ties 50 Lbs Natural
2051	50 Pcs	22-18 AWG #8 Stud Vinyl Spade	2114	100 Pcs	22-18 AWG .250 Tab Fully Insul Nylon M Disconnect	4706	50 Pcs	7.5" Nylon Wire Ties 50 Lbs UV Black
2052	50 Pcs	22-18 AWG #10 Stud Vinyl Spade	2115	50 Pcs	22-18 AWG .250 Tab Fully Insul Nylon M Disconnect	4707	50 Pcs	11.5" Nylon Wire Ties 50 Lbs Natural
2054	50 Pcs	16-14 AWG #8 Stud Vinyl Spade	2116	100 Pcs	16-14 AWG .250 Tab Fully Insul Nylon M Disconnect	4708	50 Pcs	11.5" Nylon Wire Ties 50 Lbs UV Black
2055	50 Pcs	16-14 AWG #10 Stud Vinyl Spade	2117	50 Pcs	16-14 AWG .250 Tab Fully Insul Nylon M Disconnect	4725	25 Pcs	7.5" Screw Mount Ties 50 Lbs UV Black
2057	25 Pcs	12-10 AWG #8 Stud Vinyl Spade	2118	25 Pcs	12-10 AWG .250 Tab Fully Insul Nylon FM Disconnect	5022	1 Pc	Technician's Pocket Torch - Straight Head
2058	25 Pcs	12-10 AWG #10 Stud Vinyl Spade	2119	25 Pcs	12-10 AWG .250 Tab Fully Insul Nylon M Disconnect	304705	25 Pcs	7.5" Stainless Steel Ties 250 Lbs
2060	100 Pcs	22-18 AWG Vinyl Butt Connectors	4004	25 Pcs	Heat Shrink Tubing 4" Cut - Black - 3/16"	1220-1	25 Pcs	18-14 AWG Tap Splice Connectors White
2061	100 Pcs	16-14 AWG Vinyl Butt Connectors	4005	25 Pcs	Heat Shrink Tubing 4" Cut - Black - 1/4"	1220-2	25 Pcs	22-16 AWG Tap Splice Connectors w/Stop Red
2062	50 Pcs	12-10 AWG Vinyl Butt Connectors	4006	10 Pcs	Heat Shrink Tubing 4" Cut - Black - 3/8"			
2065	100 Pcs	22-18 AWG Nylon Insul Butt Connectors	4057	25 Pcs	Heat Shrink Tubing 4" Cut - Rainbow - 3/16"			

# Introducing The **JT&T NOW Program**

The JT&T Now Program is the guaranteed, effortless way to start enjoying the benefits of the industry leader in wiring accessories.

At JT&T we understand the challenges you face in changing suppliers. This is why we've developed our JT&T NOW Program in order to provide a simple, streamlined approach that makes it hassle free to switch. It's never been easier to start working with the number one name in wiring accessories.

- Rapid and Easy Changeover
- 100% Stock Lift Credit
- Guaranteed Satisfaction
- We Handle Merchandising Breakdown and Set-Up

#### FULL Satisfaction Guarantee

After one year of using JT&T we will ask for an honest evaluation of our product line and services. If you are not completely satisfied with our products and our service, and at your request, we will remove our product and provide you with a 100% refund for all of your remaining JT&T product.

At JT&T, we make it risk-free and so simple that it leads to the most obvious question of all:

## "Why not?"



The JT&T Wiring Accessories Merchandiser Tune up your sales with a new 8900 Merchandiser. 460 SKUs, and 460 opportunities to maximize your revenues. Available in Spinner or Gondola form, the 8900 Merchandisers will maximize your revenues while minimizing the amount of used floor space.



**CONTACT YOUR LOCAL JT&T DISTRIBUTOR  
FOR MORE INFORMATION**

TO FIND A LOCAL DISTRIBUTOR CALL 800.633.3655 SALES@JTTPRODUCTS.COM