

PLEASE CHECK WWW.MOLEX.COM FOR LATEST PART INFORMATION

Part Number: **0443001800**
Status: **Active**
Overview: Micro-Fit 3.0 Connector System Product Family
Description: Micro-Fit BMI™ Plug Housing, Dual Row, Panel Mount, 18 Circuits

Documents:

3D Model	Product Specification TS-44300-001-001 (PDF)
Drawing (PDF)	Product Specification TS-46235-001-001 (PDF)
Product Specification PS-44300-001 (PDF)	Packaging Specification PK-44300-001-001 (PDF)
Product Specification TS-43045-001-001 (PDF)	RoHS Certificate of Compliance (PDF)
Product Specification TS-43045-002-001 (PDF)	Product Literature (PDF)

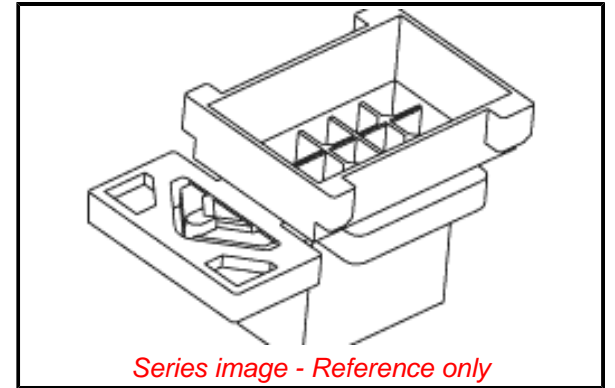

Agency Certification

CSA	LR19980
UL	E29179

General

Product Family	Crimp Housings
Series	<u>44300</u>
Application	Power, Wire-to-Board, Wire-to-Wire
Overview	<u>Micro-Fit 3.0 Connector System Product Family</u>
Product Literature Order No	987650-5984
Product Name	Micro-Fit BMI™
UPC	800753281950

Physical

Circuits (maximum)	18
Color - Resin	Black
Flammability	94V-0
Gender	Plug
Glow-Wire Compliant	No
Lock to Mating Part	No
Material - Resin	Polyester
Net Weight	4.400/g
Number of Rows	2
Packaging Type	Bag
Panel Mount	Yes
Pitch - Mating Interface	3.00mm
Polarized to Mating Part	Yes
Stackable	No
Temperature Range - Operating	-40°C to +105°C

Electrical

Current - Maximum per Contact	5.0A
-------------------------------	------

Solder Process Data

Lead-free Process Capability	N/A
------------------------------	-----

Material Info

Reference - Drawing Numbers

Packaging Specification	PK-44300-001-001
Product Specification	PS-44300-001, TS-43045-001-001, TS-43045-002-001, TS-44300-001-001, TS-46235-001-001
Sales Drawing	SD-44300-001

EU ELV

Not Relevant

EU RoHS

Compliant

REACH SVHC

Not Contained Per -
ED/30/2017 (7 July
2017)

Halogen-Free

Status

Not Low-Halogen

Need more information on product environmental compliance?

Email productcompliance@molex.com
Please visit the [Contact Us](#) section for any non-product compliance questions.

China ROHS	Green Image
ELV	Not Relevant
RoHS Phthalates	Not Contained

Search Parts in this Series

44300 Series

Mates With

44133 , 44764 , 44769

Use With

43031 Micro-Fit 3.0™ Male Crimp Terminals

PLEASE CHECK WWW.MOLEX.COM FOR LATEST PART INFORMATION