

THIS DRAWING IS UNPUBLISHED. RELEASED FOR PUBLICATION .19 .
 © COPYRIGHT 1971, 74, 75, 79, 80, 81, 82, 90 BY AMP INCORPORATED. ALL INTERNATIONAL RIGHTS RESERVED.

LOC		DIST		P		F		ZONE		LTR		REVISIONS		DATE	APPD
AG		1										BB	REV PER 063C-0014-02	28JUN02	HW

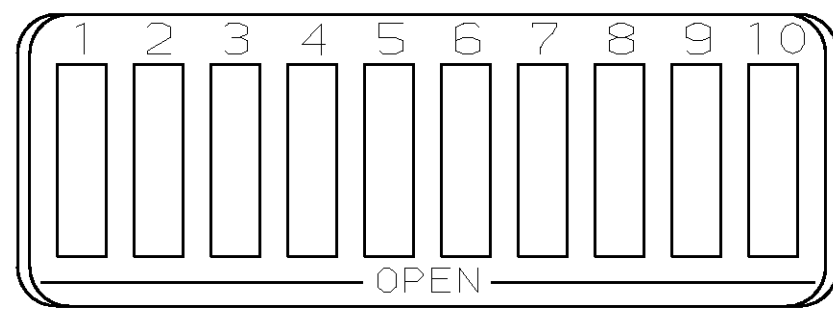

- FOR ADDITIONAL SPECIFICATIONS SEE AMP PRODUCT SPEC 108-7519.
 - SWITCH SHOWN IN OPEN POSITION.
 - ALL CHARACTERS AND ROCKERS ARE WHITE, HOUSING IS BLACK.
 - STAMPING WILL VARY ON 2 AND 3 POSITION SIDES DUE TO SPACE RESTRICTIONS.
- △ .315 DIMENSION APPLIES AT TERMINAL TIPS. TERMINALS ARE .300^{+.010}/_{-.000} AT MOUNTING SURFACE.
- △ STRIPPABLE TRANSPARENT SEAL, SEE FIG 1.
- △ STAMPED CUSTOMER PART NO, SEE FIG 5.
- △ NO PART NO, LOGO AND DATE CODE. SEE FIG 6.

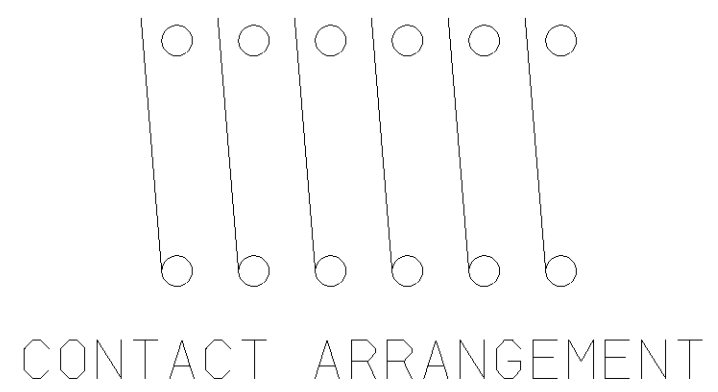
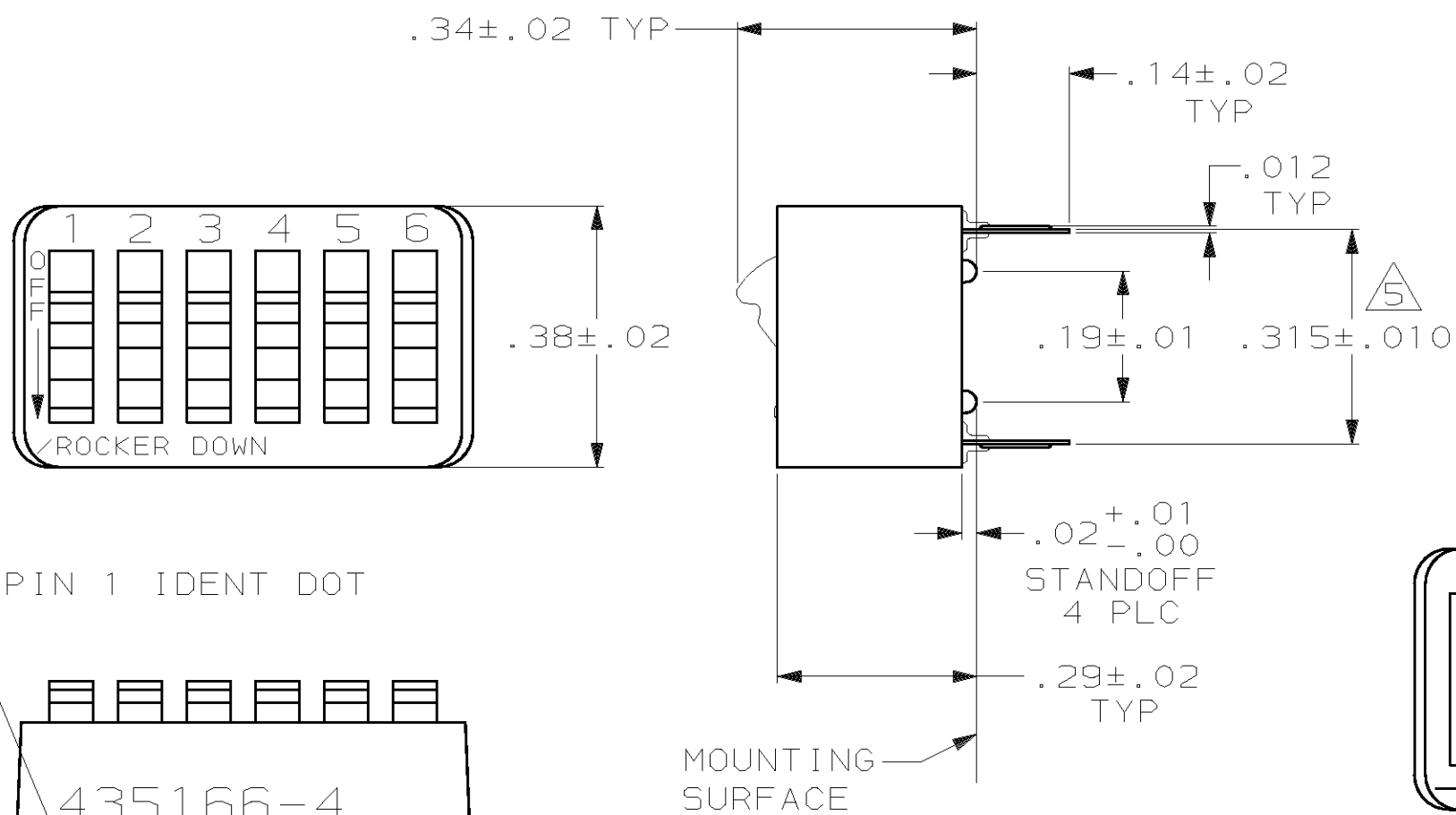
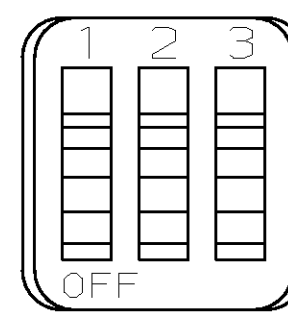
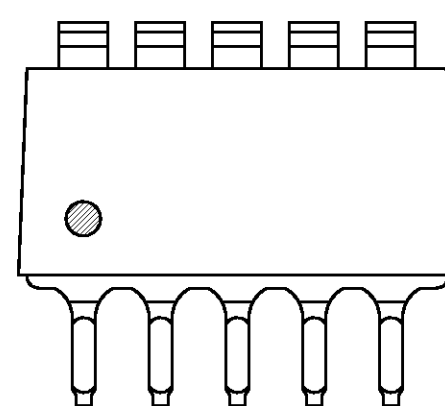
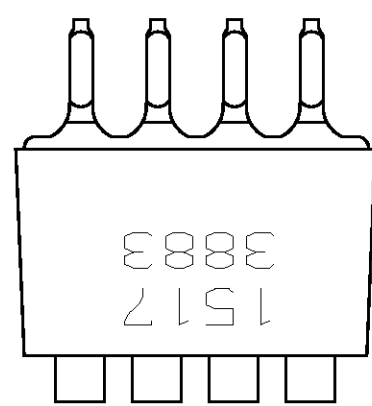
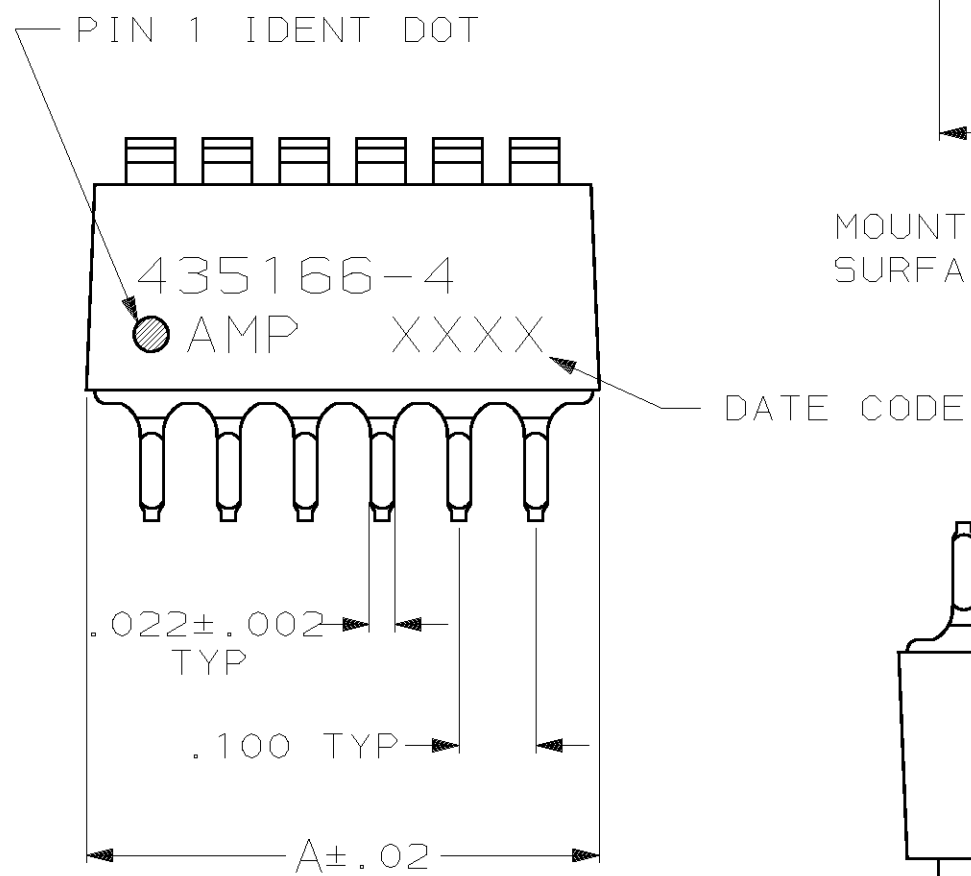
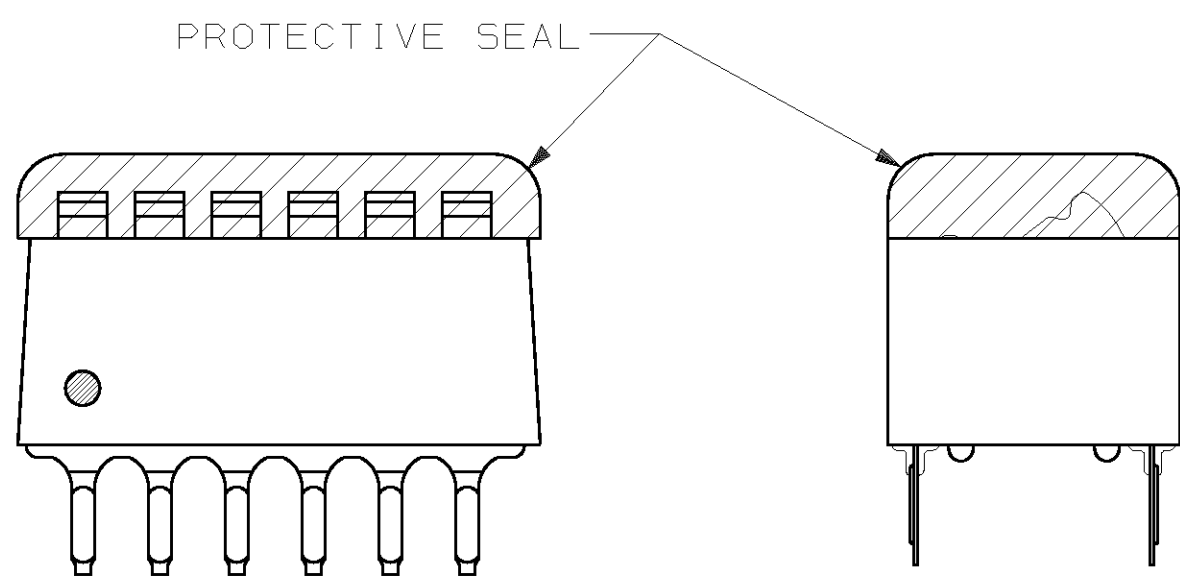
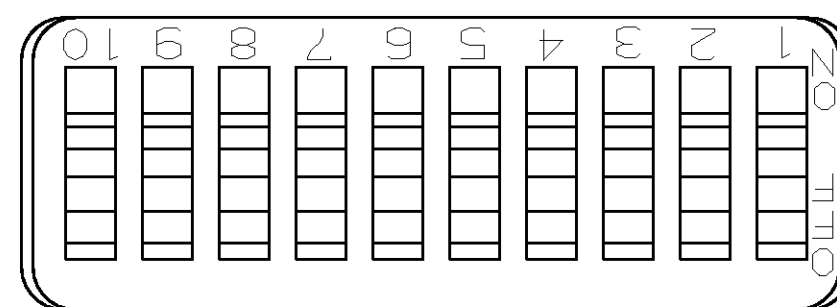
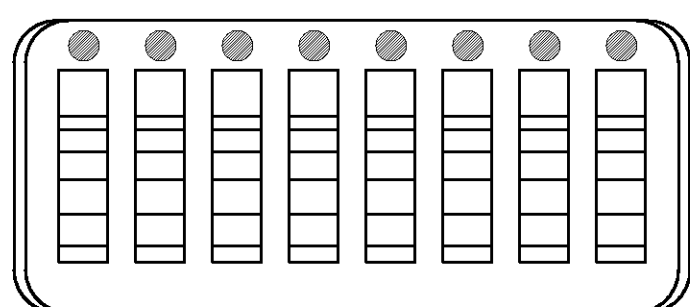
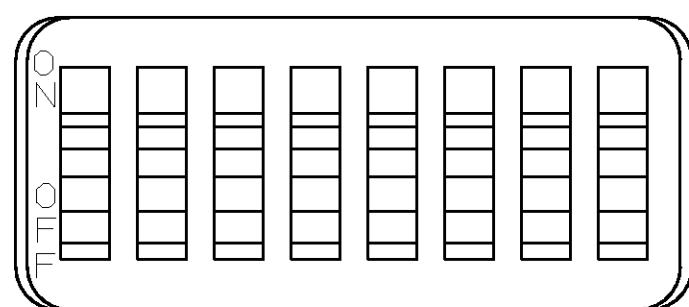

FIG	SEAL	NO OF POSN	PART NO
FIG 8	△6	1.08	10 7-435166-4
OBS NONE	△8	.58	5 7-435166-3
OBS FIG 4		1.08	10 6-435166-0
OBS NONE		1.28	12 5-435166-9
OBS		1.28	12 5-435166-7
OBS		1.08	10 5-435166-5
OBS		.98	9 5-435166-4
OBS		.88	8 5-435166-3
OBS	△6	.78	7 5-435166-2
OBS		.68	6 5-435166-1
OBS		.58	5 5-435166-0
OBS		.48	4 4-435166-9
OBS		.38	3 4-435166-8
OBS	△7	.48	4 4-435166-6
OBS		.78	7 3-435166-5
OBS		1.28	12 3-435166-2
OBS		.38	3 3-435166-0
OBS		.28	2 2-435166-9
OBS		.88	8 2-435166-8
OBS		1.08	10 435166-7
OBS		.98	9 435166-6
OBS		.88	8 435166-5
OBS		.68	6 435166-4
OBS		.58	5 435166-3
OBS		.48	4 435166-2
OBS		.78	7 435166-1



435166-4 SHOWN

DO NOT SCALE PRINT. UNLESS SPECIFIED DIMENSIONS IN INCHES TOLERANCES ON : 2 PLC DEC ± - 3 PLC DEC ± .005 ANGLES ± -	DR R.TALLEY 11-17-89 CHK 3-6-90 R.MILLER APPD 3-7-90 H.LEITER	AMP INCORPORATED Harrisburg, Pa. 17105	
MATERIAL HOUSING & ROCKERS; POLYESTER CONTACTS; BERYLLIUM COPPER	APPD - PRODUCT SPEC -	NAME SWITCH ASSY, DIP, TYPE C, 7000 SERIES, SPST, STANDARD	
FINISH CONTACTS, PLATED .000030 MIN GOLD IN CONTACT AREA OVER .000050 MIN NICKEL	APPLICATION SPEC - WEIGHT -	SIZE C CAGE CODE 00779 SCALE 4:1	DRAWING NO 435166 SHEET 1 OF 1