

Product description	Size A female connector (panel mount), Contacts: 2+PE, 6.0 - 8.0 mm, not shielded, screw clamp, IP40 without seal, UL, ESTI+, VDE
Area	Size A series 210
Order number	43 1700 000 03

Illustration

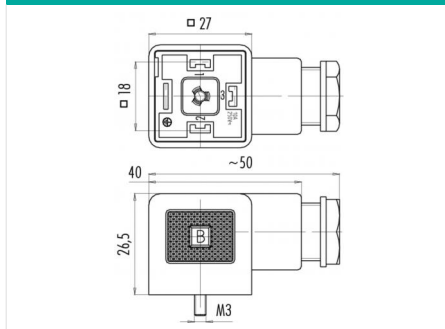

Scale drawing



Contact arrangement

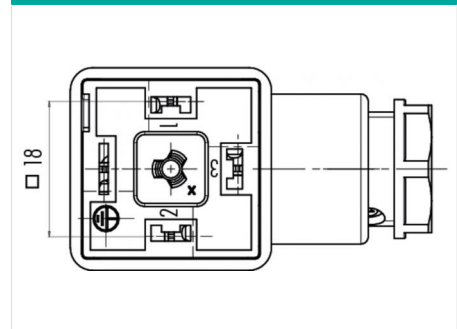

You can find the component part drawing on the next page.

Technical data

General values

Connector design	female connector (panel mount)
Connector locking system	central bolt
Termination	screw clamp
Wire gauge (mm)	min. 0.34 mm ² - max. 1.50 mm ²
Cable outlet	6.0 - 8.0 mm
Upper limit temperature	120 °C
Lower limit temperature	- 30 °C
Customs tariff number	85369010
Packaging Unit	200

Cable data

Approval 1	UL
Approval 2	ESTI+
Approval 3	VDE

Electrical values

Rated current (40 °C)	10 A
Rated voltage	250 V
Rated impulse voltage	4000 V
Pollution degree	3
Overvoltage category	III
Insulating material group	III
Insulation resistance	≥ 10 ¹⁰ Ω
EMC compliance	not shielded
Degree of protection	IP40 without seal IP65 with seal, see accessories
Degree of protection 2	IP65 with seal, see accessories
Mechanical operation	> 50 Mating cycles

Material

Contact material	CuSn (bronze)
Contact plating	Ni (nickel)
Contact body material	PA (UL94 HB)
Housing material	PA

Product description	Size A female connector (panel mount), Contacts: 2+PE, 6.0 - 8.0 mm, not shielded, screw clamp, IP40 without seal, UL, ESTI+, VDE
Area	Size A series 210
Order number	43 1700 000 03

Component part drawing

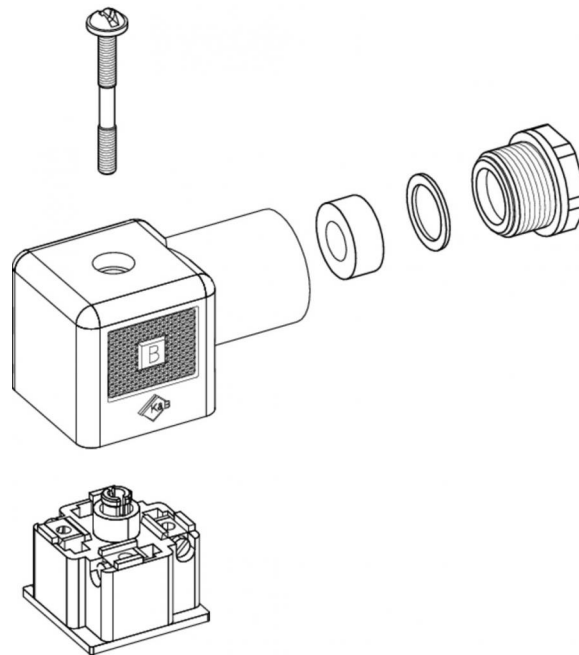

Product description	Size A female connector (panel mount), Contacts: 2+PE, 6.0 - 8.0 mm, not shielded, screw clamp, IP40 without seal, UL, ESTI+, VDE
Area	Size A series 210
Order number	43 1700 000 03

Security notices

The connector must not be connected or separated under load. Non-observance and incorrect use can result in personal injury.

The connectors are designed for use in plant, control system and electrical equipment. The end user is responsible for checking whether the connectors are suitable for use in other applications.

Connectors used in electrical circuits containing hazardous life parts must only be assembled and used by or under the supervision of persons with the requisite electrotechnical training, taking the applicable regulations and standards into account.

Connectors with degree of protection IP 67 and IP 68 are not suitable for use under water. When used outdoors, the connectors must be separately protected against corrosion. For further information about IP degrees of protection refer to 'Technical support' in the Download Centre.