

IEC Appliance Inlet C14 with Fuseholder 1- or 2-pole and Voltage Selector

Standard or Medical Fuse drawer



Fuse drawer must be ordered separately (see accessories).

Fuse drawer must be ordered separately (see accessories).



Description

- Panel Mount:
Screw-on version from front or rear side, snap-in version from front side
- 3 Functions:
Appliance Inlet Protection class I, Fuseholder with interchangeable fuse drawer for Fuse-links 5x20 mm or 6.3x32 mm 1- or 2-pole, with or without voltage selector (step switch)
- Quick connect terminals 4.8 x 0.8 mm

Approvals

- VDE Certificate Number: 40030345
- UL File Number: E93617
- CSA File Number: 38456
- CCC File Number: 2010010204409773

Characteristics

- Available with or without internal connections
- The fuse drawer "Fingerrip" can be removed by hand
- Suitable for use in equipment according to IEC/UL 60950

Other versions on request

- Fuse drawer with other voltage values
- For protection class II
- Variant with notch for V-Lock mating Cordsets

References

Alternative: version with line filter [KFC](#)

Weblinks

[pdf-datasheet](#), [html-datasheet](#), [General Product Information](#), [Approvals](#), [CE declaration of conformity](#), [RoHS](#), [CHINA-RoHS](#), [REACH](#), [Mating Connectors](#), [e-Shop](#), [SCHURTER-Stock-Check](#), [Distributor-Stock-Check](#), [CAD-Drawings](#), [Accessories](#), [Detailed request for product](#)

Newly available variants corresponding to V-Lock mating cordset. The connector is equipped with a notch intended for use with the latching cordset. The cord latching system prevents against accidental removal of the cordset.

Technical Data

Ratings IEC	10 A / 250 VAC; 50 Hz	Appliance Inlet	C14 acc. to IEC 60320, UL 498, CSA C22.2 no. 42 (for cold conditions) pin-temperature 70 °C, 10 A, Protection Class I
Ratings UL/CSA	13 A / 125 VAC; 60 Hz ¹⁾	Fuseholder	1 or 2 pole, Shocksafe category PC2 acc. to IEC 60127-6, for fuse-links 5 x 20 or 6.3 x 32 mm
Dielectric Strength	> 3 kVAC between L-N > 4 kVAC between L/N-PE (1 min/50 Hz)	Rated Power Acceptance @ Ta 23 °C	5 x 20: 2.5 W (1 pole)/ 2 W (2-pole) per pole 6.3 x 32: 3.15 W (1 pole)/ 2.5 W (2-pole) per pole
Allowable Operation Temp.	-25 °C to 70 °C	Power Acceptance @ Ta > 23 °C	Admissible power acceptance at higher ambient temperature see derating curves
Degree of Protection	from front side IP 40 acc. to IEC 60529	Voltage Selector	optional, step, 2-4 digits
Protection Class	Suitable for appliances with protection class I acc. to IEC 61140		
Terminal	Quick connect terminals 4.8 x 0.8 mm		
Panel Thickness s	Screw: max 8 mm Mounting screw torque max 0.5 Nm Snap-in: 1.5/2/2.5 mm		
Material: Housing	Thermoplastic, black, UL 94V-0		

¹⁾ UL/CSA: 1-pole version 13 A, 2-pole version 10 A

Dimensions

Screw-on mounting

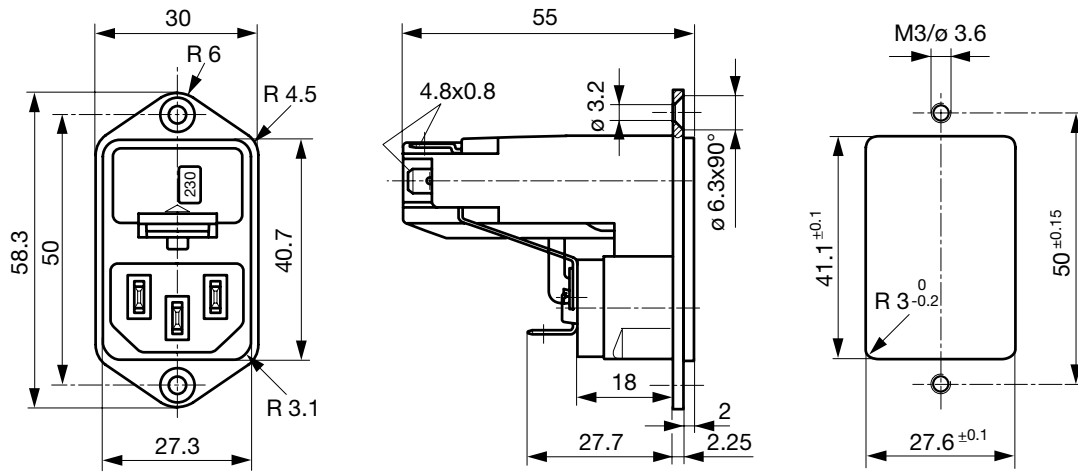

Snap-in mounting

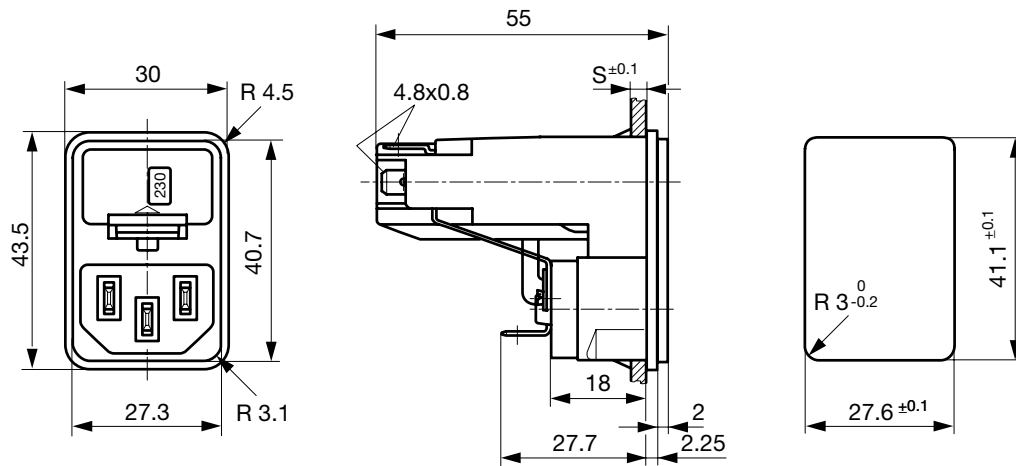

Diagrams

without internal connections
 Voltage selector
 4-positions, 1-pole

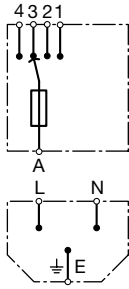

without internal connections
 Voltage selector
 4-positions, 2-pole

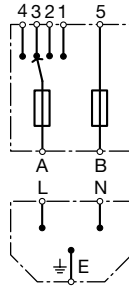

with internal connections
 Voltage selector
 4-positions, 1-pole

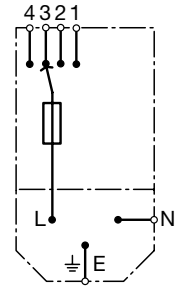

with internal connections
 Voltage selector
 4-positions, 2-pole

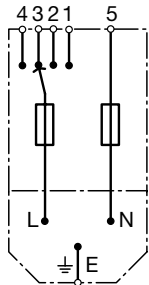

Voltage selector
 3-positions
 1-pole

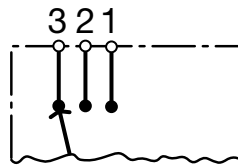

Voltage selector
 3-positions
 2-pole

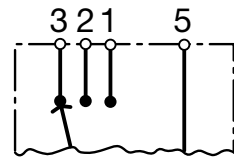

Voltage selector
 2-positions
 1-pole

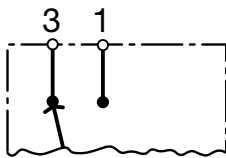

Voltage selector
 2-positions
 2-pole

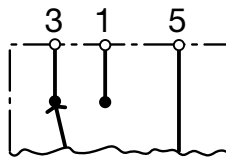

without voltage selector
 1-pole

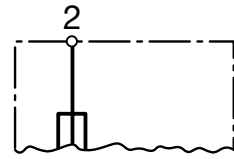

without voltage selector
 2-pole

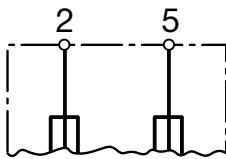

Derating Curves

Fuses

5 x 20 mm (1-pole)

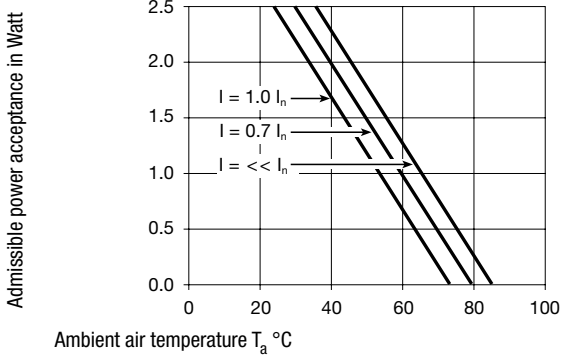

Fuses

5 x 20 mm (2-pole, per pole)

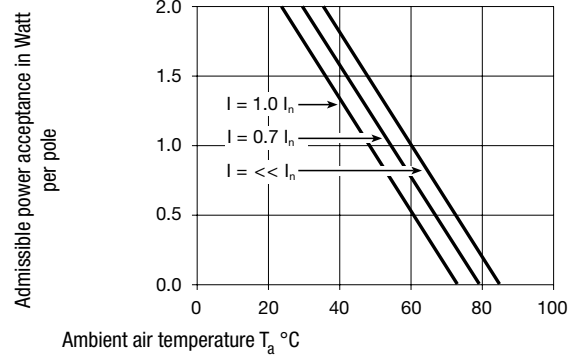

Fuses

6.3 x 32 mm (1-pole)

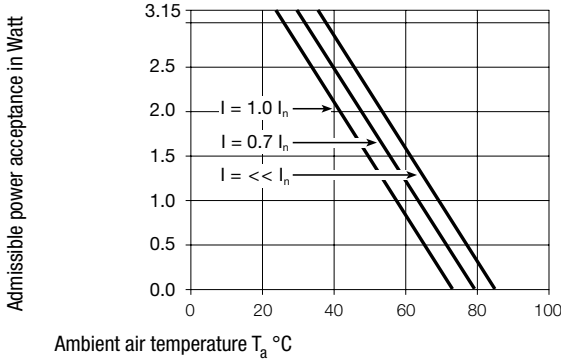

Fuses

6.3 x 32 mm (2-pole, per pole)

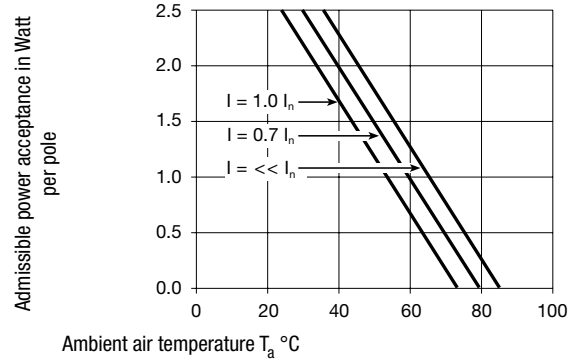

All Variants

Panel mounting	Panel Thickness s [mm]	Fuseholder	Voltage Selector	Internally wired	Order Number
Snap-in	1.5	1-pole	-	●	4303.0032
Snap-in	1.5	1-pole	3/4 digits	●	4303.0092
Snap-in	1.5	1-pole	2 pos.	●	4303.0212
Snap-in	2	1-pole	-	●	4303.0033
Snap-in	2	1-pole	3/4 digits	●	4303.0093
Snap-in	2	1-pole	2 pos.	●	4303.0213
Snap-in	2.5	1-pole	-	●	4303.0034
Snap-in	2.5	1-pole	3/4 digits	●	4303.0094
Snap-in	2.5	1-pole	2 pos.	●	4303.0214
Snap-in	1.5	1-pole	-		4303.1032
Snap-in	1.5	1-pole	3/4 digits		4303.1092
Snap-in	1.5	1-pole	2 pos.		4303.1212
Snap-in	2	1-pole	-		4303.1033
Snap-in	2	1-pole	3/4 digits		4303.1093
Snap-in	2	1-pole	2 pos.		4303.1213
Snap-in	2.5	1-pole	-		4303.1034
Snap-in	2.5	1-pole	3/4 digits		4303.1094
Snap-in	2.5	1-pole	2 pos.		4303.1214
Snap-in	1.5	2-pole	-	●	4303.0002
Snap-in	1.5	2-pole	3/4 digits	●	4303.0062
Snap-in	1.5	2-pole	2 pos.	●	4303.0182
Snap-in	2	2-pole	-	●	4303.0003
Snap-in	2	2-pole	3/4 digits	●	4303.0063
Snap-in	2	2-pole	2 pos.	●	4303.0183
Snap-in	2.5	2-pole	-	●	4303.0004

Panel mounting	Panel Thickness [mm]	Fuseholder	Voltage Selector	Internally wired	Order Number
Snap-in	2.5	2-pole	3/4 digits	●	4303.0064
Snap-in	2.5	2-pole	2 pos.	●	4303.0184
Snap-in	1.5	2-pole	-		4303.1002
Snap-in	1.5	2-pole	3/4 digits		4303.1062
Snap-in	1.5	2-pole	2 pos.		4303.1182
Snap-in	2	2-pole	-		4303.1003
Snap-in	2	2-pole	3/4 digits		4303.1063
Snap-in	2	2-pole	2 pos.		4303.1183
Snap-in	2.5	2-pole	-		4303.1004
Snap-in	2.5	2-pole	3/4 digits		4303.1064
Snap-in	2.5	2-pole	2 pos.		4303.1184
Screw	-	1-pole	-	●	4303.0031
Screw	-	1-pole	3/4 digits	●	4303.0091
Screw	-	1-pole	2 pos.	●	4303.0211
Screw	-	1-pole	-		4303.1031
Screw	-	1-pole	3/4 digits		4303.1091
Screw	-	1-pole	2 pos.		4303.1211
Screw	-	2-pole	-	●	4303.0001
Screw	-	2-pole	3/4 digits	●	4303.0061
Screw	-	2-pole	2 pos.	●	4303.0181
Screw	-	2-pole	-		4303.1001
Screw	-	2-pole	3/4 digits		4303.1061
Screw	-	2-pole	2 pos.		4303.1181

Most Popular.

Availability for all products can be searched real-time: <http://www.schurter.com/en/Stock-Check/Stock-Check-SCHURTER>

Suffix ".21" corresponds to the version with V-Lock mating cordset. The connector is equipped with a notch intended for use with the latching cordset. The cord latching system prevents against accidental removal of the cordset.

Packaging unit 50 Pcs

Required Accessory

Description

Fusedrawer 3

Fusedrawer for Fuse Links 5x20 mm resp. 6.3x32 mm



Fingergrip, 5 x 20, 2-pole, Voltage Selector	4303.2014.00
Fingergrip, 5 x 20, 2-pole, Voltage Selector, 100, 120, 220, 240	4303.2014.01
Fingergrip, 5 x 20, 2-pole, Voltage Selector, 110, 150, 220	4303.2014.02
Fingergrip, 5 x 20, 2-pole, Voltage Selector, 110, 220	4303.2014.03

...

Accessories

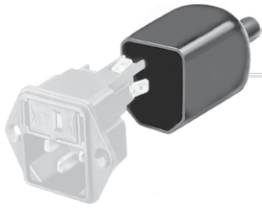

Assorted Covers
Rear Cover

0859.0072



Cord retaining kits
Cord retaining strain relief

Flat head, A

4700.0001

Mating Outlets/Connectors

Category / Description

Appliance Outlet Overview complete



IEC Appliance Outlet F, Screw-on Mounting, Front Side, Solder Terminal	4787
IEC Appliance Outlet F, Snap-in Mounting, Front Side, Solder or Quick-connect Terminal	4788
IEC Appliance Outlet F or H, Screw-on Mounting, Front Side, Solder, PCB or Quick-connect Terminal	5091

Appliance Outlet further types to KEC

Connector Overview complete



4782 Mounting: Power Cord, 3 x 1 mm ² / 3 x 18 AWG, Cable, Connector: IEC C13	4782
4022 Mounting: Power Supply Cord, 3 x 1.5 mm ² , Screw clamps, Connector: IEC C13	4022
4785 Mounting: Power Cord, 3 x 1 mm ² / 3 x 18 AWG, Cable, Connector: IEC C13	4785
4300-06 Mounting: Power Cord, 3 x 1 mm ² / 3 x 18 AWG, Cable, Connector: IEC C13	4300-06
4012 Mounting: Power Supply Cord, 3 x 1.5 mm ² , Screw clamps, Connector: IEC C13	4012

Connector further types to KEC

...

Mating Outlets/Connectors shuttered

Power Cord Overview complete



VAC17KS, North America, 2.0 m, Connector C17, cord end:	6051.2801
VAC17KS, Europlug, 2.0 m, Connector IEC C17, cord end:	6051.2803
VAC17KS, Europlug, 2.0 m, Connector IEC C17, cord end:	6051.2813
VAC13KS, Overview, diverse Connector IEC C13, cord end:	VAC13KS

Power Cord further types to KEC