









Panel Mount Plugs and Sockets

	Angle Bracket, Angle Bracket Tapped, Without Angle Bracket	
	38330, 38336	p. 2-3
	38540	p. 16-17
	Shallow Bracket	
	38330	p. 4-5
	38542	p. 18-19
	Deep Bracket	
	38330, 38336	p. 6-7
	38540	p. 20-21

Cable Mount Plugs and Sockets

	Cable Clamp End	
	38331, 38336	p. 8-9
	38541	p. 22-23
	Cable Clamp Top, Cable Clamp Top with Keeper, Cable Clamp Top with Latch	
	38330, 38331, 38336	p. 10-11
	38541	p. 24-25
	Flared Hole End	
	38330, 38336	p. 12-13
	38540	p. 26-27
	Flared Hole Top	
	38330, 38331, 38336	p. 14-15
	38540	p. 28-29



Beau™ Power Connectors Panel Mount Plugs and Sockets

FEATURES AND SPECIFICATIONS

Features and Benefits

- Sizes 2 to 33 circuits
- Robust blade contacts resist damage from improper mating
- Large surface area of dual wipe female contact produces maximum current capacity
- No de-rating required. All circuits rated for full current load
- Extra long pre-grounding contact engages before any other contacts for greater safety.

Electrical

Voltage: 250V
Maximum Current: 10 Amp

Mechanical

Operating Temperature: 150°C

Physical

Base Insulator: High-grade phenolic, black
Plug Contact: Brass
Plug Contact Plating: Tin
Socket Contact: Phosphor bronze
Socket Contact Plating: Tin
Pre-grounding Contact: Heavy-duty plated brass

Reference Information

UL : File E34763
CSA: File 22156

38330, 38336

- Angled Bracket (AB)
- Angle Bracket Tapped (ABT)
- Less Angle Bracket (LAB)

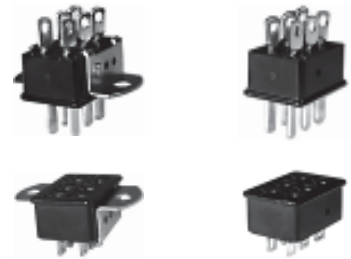

SUGGESTED PANEL MOUNTING DIMENSIONS

CONTACT TAILS

Molex offers a wide selection of contact tails. Consult factory for availability and part numbers of other styles

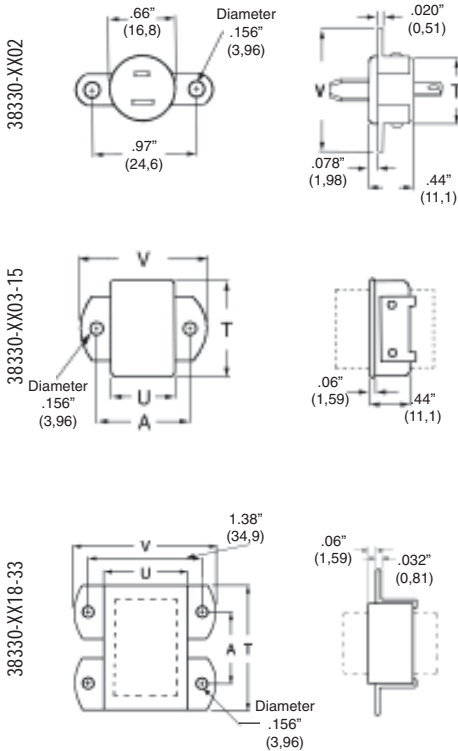

Fig. D

Fig. E

Fig. F

Fig. G

P Solder Eye (Standard)

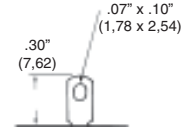

P₁ Printed Circuit and Wire Wrap, Short

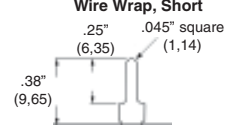

S₁ Quick Connect

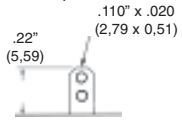

P₁ Quick Connect

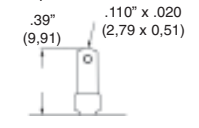

S Solder Eye (Standard)

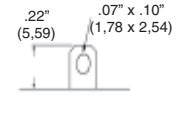

S₁ Printed Circuit

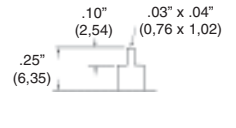

P₁ Wire Wrap, Long

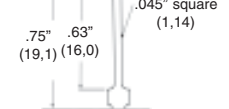

Contact Orientation

The polarization arrangement numbers shown below are for sockets, as viewed from the wiring side. Plug numbering is the opposite. A heavy-duty polarizing/ground contact is in position 14 for Nos. 3324, 3327, 3330 and in position 17 for No. 3333. * Indicates location of pre-grounding contact. † Pregrounding contact is standard.



38330-XX02



38330-XX03



38330-XX04



38330-XX06



38336-8XXX

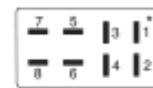

38330-XX08



38330-XX10

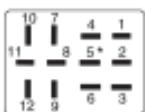

38330-XX12



38330-XX15 to 38330-XX21



38330-XX24 to 38330-XX30



38330-XX33



38330, 38336

Part#	T		U		V	
	in	mm	in	mm	in	mm
3302*	0.66	16,7	--	--	1.27	32,1
3303	1.00	25,4	.44	11,1	1.06	27,0
3304	0.75	19,1	.69	17,5	1.31	33,3
3306	1.00	25,4	.69	17,5	1.31	33,3
3306-8	1.00	25,4	.69	17,5	1.31	33,3
3308	1.25	31,8	.69	17,5	1.31	33,3
3310	1.56	39,7	.69	17,5	1.31	33,3
3312	1.25	31,8	.94	23,8	1.56	39,7
3315	1.63	41,3	1.00	25,4	1.69	42,9
3318	1.94	49,2	1.00	25,4	1.69	42,9
3321	2.25	57,2	1.00	25,4	1.69	42,9
3324	2.56	65,1	1.00	25,4	1.69	42,9
3327	2.88	73,0	1.00	25,4	1.69	42,9
3330	3.19	81,0	1.00	25,4	1.69	42,9
3333	3.50	88,9	1.00	25,4	1.69	42,9

Part #	Fig.#	A		B		C	
		in	mm	in	mm	in	mm
3302*	D	.969	24,6	--	--	--	--
3303	E	.750	19,1	1.016	25,8	.453	11,5
3304	F	1.000	25,4	.781	19,8	.719	18,3
3306	E	1.000	25,4	1.031	26,2	.719	18,3
3306-8	E	1.000	25,4	1.031	26,2	.719	18,3
3308	F	1.000	25,4	1.281	32,5	.719	18,3
3310	F	1.000	25,4	1.578	40,1	.719	18,3
3312	F	1.250	31,8	1.266	32,2	.953	24,2
3315	F	1.375	34,9	1.640	41,7	1.016	25,8
3318	G	1.250	31,8	1.953	49,6	--	--
3321	G	.938	23,8	2.265	57,5	--	--
3324	G	1.250	31,8	2.578	65,5	--	--
3327	G	1.562	39,7	2.890	73,4	--	--
3330	G	1.875	47,6	3.203	81,4	--	--
3333	G	2.188	55,6	3.515	89,3	--	--

PLUGS

Angle Bracket (-AB)		Angle Bracket Tapped (-ABT)		Less Angle Bracket (-LAB)	
Order #	Engineering #	Order #	Engineering #	Order #	Engineering #
38330-0102	P-3302-AB	38330-1502	P-3302-ABT	38330-2202	P-3302-LAB
38330-0103	P-3303-AB	38330-1503	P-3303-ABT	38330-2203	P-3303-LAB
38330-0104	P-3304-AB	38330-1504	P-3304-ABT	38330-2204	P-3304-LAB
38330-0106	P-3306-AB	38330-1506	P-3306-ABT	38330-2206	P-3306-LAB
38336-8001	P-3306-8-AB	38336-8015	P-3306-8-ABT	38336-8022	P-3306-8-LAB
38330-0108	P-3308-AB	38330-1508	P-3308-ABT	38330-2208	P-3308-LAB
38330-0110	P-3310-AB	38330-1510	P-3310-ABT	38330-2210	P-3310-LAB
38330-0112	P-3312-AB	38330-1512	P-3312-ABT	38330-2212	P-3312-LAB
38330-0115	P-3315-AB	38330-1515	P-3315-ABT	38330-2215	P-3315-LAB
38330-0118	P-3318-AB	38330-1518	P-3318-ABT	38330-2218	P-3318-LAB
38330-0121	P-3321-AB	38330-1521	P-3321-ABT	38330-2221	P-3321-LAB
38330-0124	P-3324-AB	38330-1524	P-3324-ABT	38330-2224	P-3324-LAB
38330-0127	P-3327-AB	38330-1527	P-3327-ABT	38330-2227	P-3327-LAB
38330-0130	P-3330-AB	38330-1530	P-3330-ABT	38330-2230	P-3330-LAB
38330-0133	P-3333-AB	38330-1533	P-3333-ABT	38330-2233	P-3333-LAB

SOCKETS

Angle Bracket (-AB)		Angle Bracket Tapped (-ABT)		Less Angle Bracket (-LAB)	
Order #	Engineering #	Order #	Engineering #	Order #	Engineering #
38330-0502	S-3302-AB	38330-1902	S-3302-ABT	38330-2602	S-3302-LAB
38330-0503	S-3303-AB	38330-1903	S-3303-ABT	38330-2603	S-3303-LAB
38330-0504	S-3304-AB	38330-1904	S-3304-ABT	38330-2604	S-3304-LAB
38330-0506	S-3306-AB	38330-1906	S-3306-ABT	38330-2606	S-3306-LAB
38336-8005	S-3306-8-AB	38336-8019	S-3306-8-ABT	38336-8026	S-3306-8-LAB
38330-0508	S-3308-AB	38330-1908	S-3308-ABT	38330-2608	S-3308-LAB
38330-0510	S-3310-AB	38330-1910	S-3310-ABT	38330-2610	S-3310-LAB
38330-0512	S-3312-AB	38330-1912	S-3312-ABT	38330-2612	S-3312-LAB
38330-0515	S-3315-AB	38330-1915	S-3315-ABT	38330-2615	S-3315-LAB
38330-0518	S-3318-AB	38330-1918	S-3318-ABT	38330-2618	S-3318-LAB
38330-0521	S-3321-AB	38330-1921	S-3321-ABT	38330-2621	S-3321-LAB
38330-0524	S-3324-AB	38330-1924	S-3324-ABT	38330-2624	S-3324-LAB
38330-0527	S-3327-AB	38330-1927	S-3327-ABT	38330-2627	S-3327-LAB
38330-0530	S-3330-AB	38330-1930	S-3330-ABT	38330-2630	S-3330-LAB
38330-0533	S-3333-AB	38330-1933	S-3333-ABT	38330-2633	S-3333-LAB



Beau™ Power Connectors Panel Mount Plugs and Sockets

FEATURES AND SPECIFICATIONS

Features and Benefits

- Sizes 15 to 33 circuits
- Robust blade contacts resist damage from improper mating
- Large surface area of dual wipe female contact produces maximum current capacity
- No de-rating required. All circuits rated for full current load
- Extra long pre-grounding contact engages before any other contacts for greater safety.

Reference Information

UL: File E34763
CSA: File 22156

Electrical

Voltage: 250V
Maximum Current: 10 Amp

Mechanical

Operating Temperature: 150°C

Physical

Base Insulator: High-grade phenolic, black
Plug Contact: Brass
Plug Contact Plating: Tin
Socket Contact: Phosphor bronze
Socket Contact Plating: Tin
Pre-grounding Contact: Heavy-duty plated brass

38330

Shallow Bracket (SB)



SUGGESTED PANEL MOUNTING DIMENSIONS

CONTACT TAILS

Molex offers a wide selection of contact tails. Consult factory for availability and part numbers of other styles

Fig.K

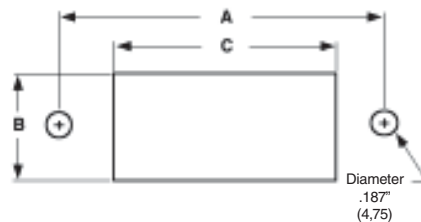
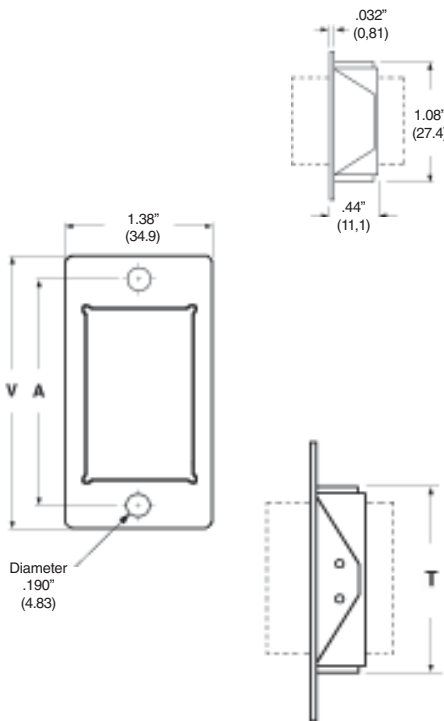

P Solder Eye (Standard)

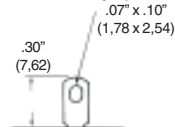

P₂ Printed Circuit and Wire Wrap, Short

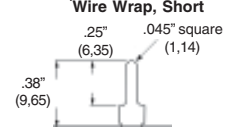

S₁ Quick Connect

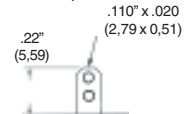

P₁ Quick Connect

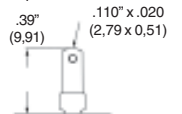

S Solder Eye (Standard)

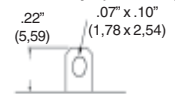

S₆ Printed Circuit

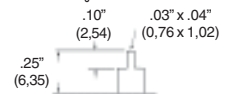

P₄ Wire Wrap, Long

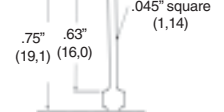

Contact Orientation

The polarization arrangement numbers shown below are for sockets, as viewed from the wiring side. Plug numbering is the opposite. A heavy-duty polarizing/ground contact is in position 14 for Nos. 3324, 3327, 3330 and in position 17 for No. 3333.



38330-XX15 to 38330-XX21



38330-XX24 to 38330-XX30



38330-XX33

• Indicates location of pre-grounding contact. † Pre-grounding contact is standard



38330

Part#	T		V	
	in	mm	in	mm
3315	1.69	42.9	2.55	58.7
3318	2.00	50.8	2.86	66.7
3321	2.31	58.7	3.17	74.6
3324	2.63	66.7	3.48	82.6
3327	2.94	74.6	3.80	90.5
3330	3.25	82.6	4.11	98.4
3333	3.56	90.5	4.42	106

Part #	Fig. #	A		B		C	
		in	mm	in	mm	in	mm
3315	K	2.125	54,0	1.156	29,4	1.750	44,5
3318	K	2.437	61,9	1.156	29,4	2.062	52,4
3321	K	2.750	69,9	1.156	29,4	2.375	60,3
3324	K	3.062	77,8	1.156	29,4	2.687	68,2
3327	K	3.375	85,7	1.156	29,4	3.000	76,2
3330	K	3.687	93,6	1.156	29,4	3.312	84,1
3333	K	4.000	102	1.156	29,4	3.625	92,1

PLUGS		SOCKETS	
Shallow Bracket (-SB)		Shallow Bracket (-SB)	
Order #	Engineering #	Order #	Engineering #
38330-6415	P-3315-SB	38330-6815	S-3315-SB
38330-6418	P-3318-SB	38330-6818	S-3318-SB
38330-6421	P-3321-SB	38330-6821	S-3321-SB
38330-6424	P-3324-SB	38330-6824	S-3324-SB
38330-6427	P-3327-SB	38330-6827	S-3327-SB
38330-6430	P-3330-SB	38330-6830	S-3330-SB
38330-6433	P-3333-SB	38330-6833	S-3333-SB



Beau™ Power Connectors Panel Mount Plugs and Sockets

FEATURES AND SPECIFICATIONS

Features and Benefits

- Sizes 2 to 33 circuits
- Robust blade contacts resist damage from improper mating
- Large surface area of dual wipe female contact produces maximum current capacity
- No de-rating required. All circuits rated for full current load
- Extra long pre-grounding contact engages before any other contacts for greater safety.

Electrical

Voltage: 250V
Maximum Current: 10 Amp

Mechanical

Operating Temperature: 150°C

Physical

Base Insulator: High-grade phenolic, black
Plug Contact: Brass
Plug Contact Plating: Tin
Socket Contact: Phosphor bronze
Socket Contact Plating: Tin
Pre-grounding Contact: Heavy-duty plated brass

38330, 38336
Deep Bracket



Reference Information

UL: File E34763
CSA: File 22156

SUGGESTED PANEL MOUNTING DIMENSIONS

CONTACT TAILS

Molex offers a wide selection of contact tails. Consult factory for availability and part numbers of other styles

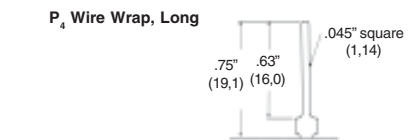
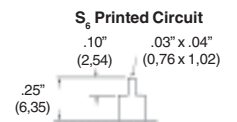
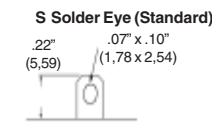
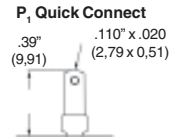
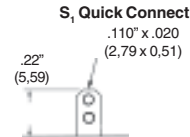
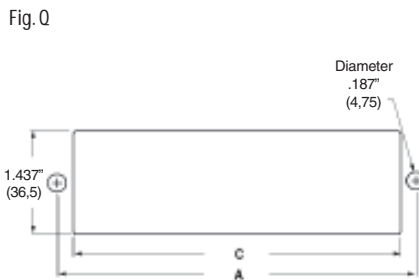
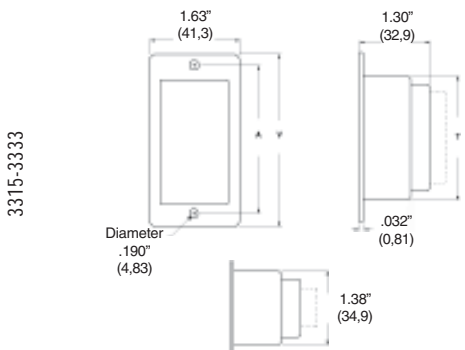
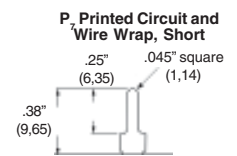
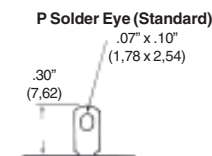
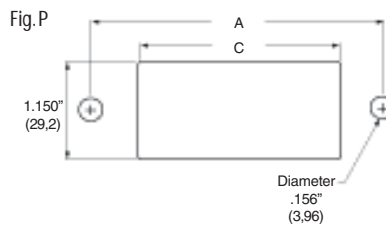
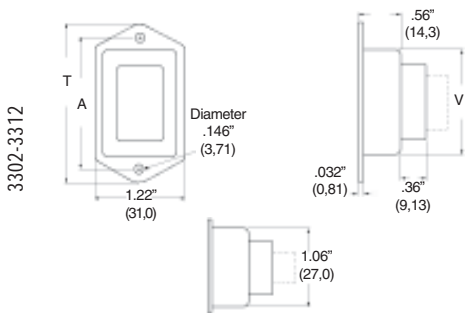

Contact Orientation

The polarization arrangement numbers shown below are for sockets, as viewed from the wiring side. Plug numbering is the opposite. A heavy-duty polarizing/ground contact is in position 14 for Nos. 3324, 3327, 3330 and in position 17 for No. 3333.



38330-XX02



38330-XX03



38330-XX04



38330-XX06



38336-8XXX



38330-XX08

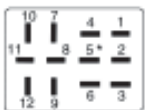

38330-XX12



38330-XX15 to 38330-XX21



38330-XX24 to 38330-XX30



38330-XX33

* Indicates location of pre-grounding contact. † Pre-grounding contact is standard



38330, 38336

Part#	T		V	
	in	mm	in	mm
3302*	1.38	34.9	2.11	53.6
3303	1.38	34.9	2.11	53.6
3304	1.38	34.9	2.11	53.6
3306	1.38	34.9	2.11	53.6
3306-8	1.38	34.9	2.11	53.6
3308	1.38	34.9	2.11	53.6
3312	1.38	34.9	2.11	53.6
3315	2.00	50.8	2.81	71.4
3318	2.31	58.7	3.13	79.4
3321	2.63	66.7	3.44	87.3
3324	2.94	74.6	3.75	95.3
3327	3.25	82.6	4.06	103
3330	3.56	90.5	4.38	111
3333	3.88	98.4	4.69	119

Part #	Fig. #	A		C	
		in	mm	in	mm
3302*	P	1.750	44.5	1.500	38.1
3303	P	1.750	44.5	1.500	38.1
3304	P	1.750	44.5	1.500	38.1
3306	P	1.750	44.5	1.500	38.1
3306-8	P	1.750	44.5	1.500	38.1
3308	P	1.750	44.5	1.500	38.1
3312	P	1.750	44.5	1.500	38.1
3315	Q	2.375	60.3	2.000	50.8
3318	Q	2.687	68.2	2.312	58.7
3321	Q	3.000	76.2	2.625	66.7
3324	Q	3.312	84.1	2.937	74.6
3327	Q	3.625	92.1	3.250	82.6
3330	Q	3.937	100	3.562	90.5
3333	Q	4.250	108	3.875	98.4

PLUGS		SOCKETS	
DeepBracket (-DB)		DeepBracket (-DB)	
Order #	Engineering #	Order #	Engineering #
38330-5702	P-3302-DB	38330-6102	S-3302-DB
38330-5703	P-3303-DB	38330-6103	S-3303-DB
38330-5704	P-3304-DB	38330-6104	S-3304-DB
38330-5706	P-3306-DB	38330-6106	S-3306-DB
38336-8057	P-3306-8-DB	38336-8061	S-3306-8-DB
38330-5708	P-3308-DB	38330-6108	S-3308-DB
38330-5712	P-3312-DB	38330-6112	S-3312-DB
38330-5715	P-3315-DB	38330-6115	S-3315-DB
38330-5718	P-3318-DB	38330-6118	S-3318-DB
38330-5721	P-3321-DB	38330-6121	S-3321-DB
38330-5724	P-3324-DB	38330-6124	S-3324-DB
38330-5727	P-3327-DB	38330-6127	S-3327-DB
38330-5730	P-3330-DB	38330-6130	S-3330-DB
38330-5733	P-3333-DB	38330-6133	S-3333-DB



Beau™ Power Connectors Cable Mount Plugs and Sockets

FEATURES AND SPECIFICATIONS

Features and Benefits

- Sizes 3 to 33 circuits
- Robust blade contacts resist damage from improper mating
- Large surface area of dual wipe female contact produces maximum current capacity
- No de-rating required. All circuits rated for full current load
- Extra long pre-grounding contact engages before any other contacts for greater safety.
- Strain relief cable clamps, used with round or flat cable

Electrical

Voltage: 250V
Maximum Current: 10 Amp

Mechanical

Operating Temperature: 110°C

Physical

Base Insulator: High-grade phenolic, black
Plug Contact: Brass
Plug Contact Plating: Tin
Socket Contact: Phosphor bronze
Socket Contact Plating: Tin

38331, 38336
Cable Clamp End (CCE)



Reference Information

UL: File E34763 CSA: File 22156

CONTACT TAILS

Molex offers a wide selection of contact tails. Consult factory for availability and part numbers of other styles

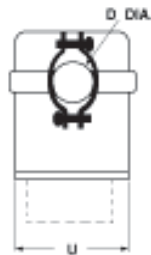
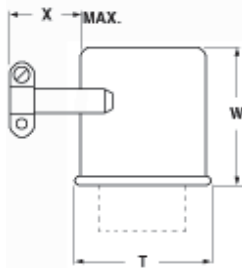

P Solder Eye (Standard)

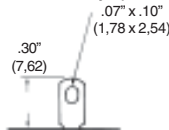

P₁ Printed Circuit and Wire Wrap, Short

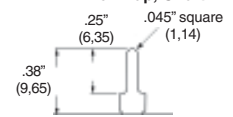

S₁ Quick Connect

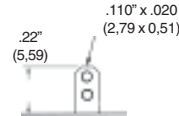

P₁ Quick Connect

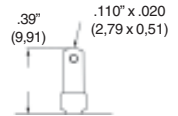

S Solder Eye (Standard)

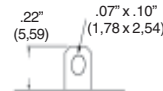

S₂ Printed Circuit

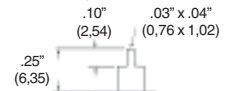

P₂ Wire Wrap, Long

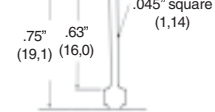

Contact Orientation

The polarization arrangement numbers shown below are for sockets, as viewed from the wiring side. Plug numbering is the opposite. A heavy-duty polarizing/ground contact is in position 14 for Nos. 3324, 3327, 3330 and in position 17 for No. 3333.



38330-XX03



38330-XX04



38330-XX06



38336-8XXX



38330-XX08



38330-XX10

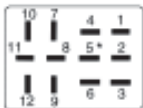

38330-XX12



38330-XX15 to 38330-XX21

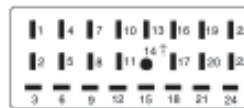

38330-XX24 to 38330-XX30



38330-XX33

* Indicates location of pre-grounding contact. † Pre-grounding contact is standard

ORDERING INFORMATION AND DIMENSIONS



Beau™ Power Connectors Cable Mount Plugs and Sockets

38330, 38336

Part#	D		T		U		W		X	
	in	mm	in	mm	in	mm	in	mm	in	mm
3303	.31	7.9	1.00	25.4	.44	11.1	.97	24.6	.50	12.7
3304	.38	9.5	.75	25.4	.69	17.5	.97	24.6	.50	12.7
3306	.44	11.1	1.00	25.4	.69	17.5	1.06	27.0	.50	12.7
3306-8	.44	11.1	1.00	25.4	.69	17.5	1.06	27.0	.50	12.7
3308	.50	12.7	1.25	31.8	.69	17.5	1.06	27.0	.50	12.7
3310	.50	12.7	1.56	39.7	.69	17.5	1.19	30.2	.50	12.7
3312	.56	14.3	1.25	31.8	.94	23.8	1.19	30.2	.50	12.7
3315	.56	14.3	1.78	45.2	1.16	29.4	1.75	44.5	.75	19.1
3318	.56	14.3	2.08	52.8	1.16	29.4	1.75	44.5	.75	19.1
3321	.63	15.9	2.34	59.5	1.16	29.4	1.75	44.5	.75	19.1
3324	.63	15.9	2.78	70.6	1.16	29.4	1.75	44.5	.75	19.1
3327	.63	15.9	3.00	76.2	1.16	29.4	1.75	44.5	.75	19.1
3330	.75	19.0	3.34	84.9	1.16	29.4	1.75	44.5	.75	19.1
3333	.75	19.0	3.66	92.9	1.16	29.4	1.75	44.5	.75	19.1

For Connector size	Clamp opening dia., in. (mm)		Clamp Number
	min	max	
Standard Clamps Sizes			
3833X-XX02	.13" (3,3)	.38" (9,7)	-
3833X-XX03	.13" (3,3)	.38" (9,7)	-
3833X-XX04 thru 3833X-XX12	.22" (5,6)	.50" (12,7)	-
3833X-XX15 thru 3833X-XX18	.38" (9,7)	.72" (18,3)	-
3833X-XX21 thru 3833X-XX33	.38" (9,7)	.84" (21,3)	-
Clamp Options			
3833X-XX15 thru 3833X-XX33	.45" (11,4)	.91" (23,1)	78
3833X-XX15 thru 3833X-XX33 for Mating with Deep Bracket (DB)	.38" (9,7)	.72" (18,3)	47

PLUGS		SOCKETS	
Cable Clamp End (CCE)		Cable Clamp End (CCE)	
Order #	Engineering #	Order #	Engineering #
38331-1403	P-3303-CCE	38331-3803	S-3303-CCE
38331-1404	P-3304-CCE	38331-3804	S-3304-CCE
38331-1406	P-3306-CCE	38331-3806	S-3306-CCE
38336-8114	P-3306-8-CCE	38336-8138	S-3306-8-CCE
38331-1408	P-3308-CCE	38331-3808	S-3308-CCE
38331-1410	P-3310-CCE	38331-3810	S-3310-CCE
38331-1412	P-3312-CCE	38331-3812	S-3312-CCE
38331-1415	P-3315-CCE	38331-3815	S-3315-CCE
38331-1418	P-3318-CCE	38331-3818	S-3318-CCE
38331-1421	P-3321-CCE	38331-3821	S-3321-CCE
38331-1424	P-3324-CCE	38331-3824	S-3324-CCE
38331-1427	P-3327-CCE	38331-3827	S-3327-CCE
38331-1430	P-3330-CCE	38331-3830	S-3330-CCE
38331-1433	P-3333-CCE	38331-3833	S-3333-CCE



Beau™ Power Connectors Cable Mount Plugs and Sockets

FEATURES AND SPECIFICATIONS

Features and Benefits

- Sizes 2 to 33 circuits
- Robust blade contacts resist damage from improper mating
- Large surface area of dual wipe female contact produces maximum current capacity
- No de-rating required. All circuits rated for full current load
- Extra long pre-grounding contact engages before any other contacts for greater safety.

Electrical

Voltage: 250V
Maximum Current: 10 Amp

Mechanical

Operating Temperature: 110°C

Physical

Base Insulator: High-grade phenolic, black
Plug Contact: Brass
Plug Contact Plating: Tin
Socket Contact: Phosphor bronze
Socket Contact Plating: Tin
Pre-grounding Contact: Heavy-duty plated brass

38330, 38331, 38336

Cable Clamp Top (CCT)
Cable Clamp Top w/ Keeper (CCT-K)
Cable Clamp Top w/ Latch (CCT-L)



Reference Information

UL: File E34763

CSA: File 22156

OPTIONS

CONTACT TAILS

For connecting two cable-mounted connectors, plug and socket can be equipped with either a latch (-L) or keeper (-K)

Molex offers a wide selection of contact tails. Consult factory for availability and part numbers of other styles

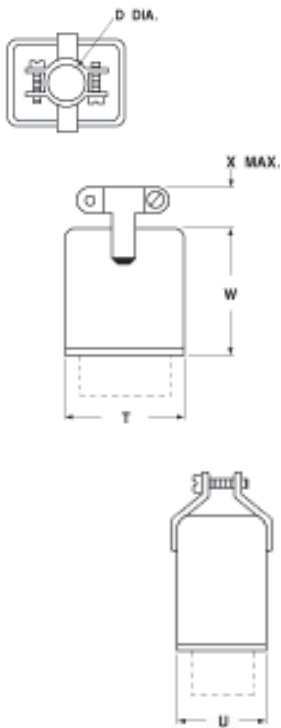

Keeper (-K)



Latch (-L)

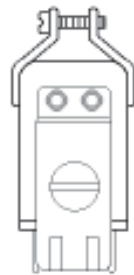

P Solder Eye (Standard)

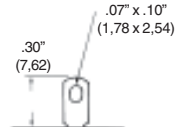

P₂ Printed Circuit and Wire Wrap, Short

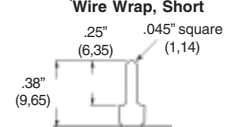

S₁ Quick Connect

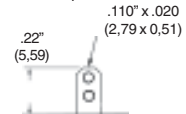

P₁ Quick Connect

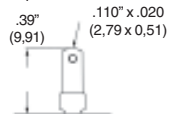

S Solder Eye (Standard)

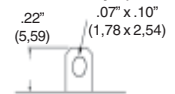

S₆ Printed Circuit

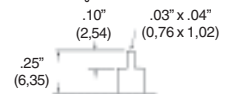

P₄ Wire Wrap, Long

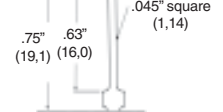

Contact Orientation

The polarization arrangement numbers shown below are for sockets, as viewed from the wiring side. Plug numbering is the opposite. A heavy-duty polarizing/ground contact is in position 14 for Nos. 3324, 3327, 3330 and in position 17 for No. 3333.



38330-XX02



38330-XX03



38330-XX04



38330-XX06



38336-8XXX



38330-XX08



38330-XX10

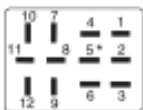

38330-XX12



38330-XX15 to 38330-XX21



38330-XX24 to 38330-XX30



38330-XX33

* Indicates location of pre-grounding contact. † Pre-grounding contact is standard

ORDERING INFORMATION AND DIMENSIONS



Beau™ Power Connectors
Cable Mount Plugs and Sockets

38330, 38336, 38336

Part#	D		T		U		W		X	
	in	mm	in	mm	in	mm	in	mm	in	mm
3302	.38	9.5	.66	16.7	-	-	.97	24.6	.50	12.7
3303	.31	7.9	1.00	25.4	.44	11.1	.97	24.6	.50	12.7
3304	.38	9.5	.75	25.4	.69	17.5	.97	24.6	.50	12.7
3306	.44	11.1	1.00	25.4	.69	17.5	1.06	27.0	.50	12.7
3306-8	.44	11.1	1.00	25.4	.69	17.5	1.06	27.0	.50	12.7
3308	.50	12.7	1.25	31.8	.69	17.5	1.06	27.0	.50	12.7
3310	.50	12.7	1.56	39.7	.69	17.5	1.19	30.2	.50	12.7
3312	.56	14.3	1.25	31.8	.94	23.8	1.19	30.2	.50	12.7
3315	.56	14.3	1.78	45.2	1.16	29.4	1.75	44.5	.75	19.1
3318	.56	14.3	2.08	52.8	1.16	29.4	1.75	44.5	.75	19.1
3321	.63	15.9	2.34	59.5	1.16	29.4	1.75	44.5	.75	19.1
3324	.63	15.9	2.78	70.6	1.16	29.4	1.75	44.5	.75	19.1
3327	.63	15.9	3.00	76.2	1.16	29.4	1.75	44.5	.75	19.1
3330	.75	19.0	3.34	84.9	1.16	29.4	1.75	44.5	.75	19.1
3333	.75	19.0	3.66	92.9	1.16	29.4	1.75	44.5	.75	19.1

For Connector size	Clamp opening dia., in. (mm)		Clamp Number
	min	max	
Standard Clamps Sizes			
3833X-XX02	.13" (3,3)	.38" (9,7)	-
3833X-XX03	.13" (3,3)	.38" (9,7)	-
3833X-XX04 thru 3833X-XX12	.22" (5,6)	.50" (12,7)	-
3833X-XX15 thru 3833X-XX18	.38" (9,7)	.72" (18,3)	-
3833X-XX21 thru 3833X-XX33	.38" (9,7)	.84" (21,3)	-
Clamp Option			
3833X-XX15 thru 3833X-XX33	.45" (11,4)	.91" (23,1)	78

PLUGS

Cable Clamp Top (-CCT)		Cable Clamp Top w/Keeper (-CCT-K)		Cable Clamp Top w/Latch (-CCT-L)	
Order #	Engineering #	Order #	Engineering #	Order #	Engineering #
38331-5602	P-3302-CCT	38331-6002	P-3302-CCT-K	38331-5802	P-3302-CCT-L
38331-5603	P-3303-CCT	38331-6003	P-3303-CCT-K	38331-5803	P-3303-CCT-L
38331-5604	P-3304-CCT	38331-6004	P-3304-CCT-K	38331-5804	P-3304-CCT-L
38331-5606	P-3306-CCT	38331-6006	P-3306-CCT-K	38331-5806	P-3306-CCT-L
38336-8156	P-3306-8-CCT	38336-8160	P-3306-8-CCT-K	38336-8158	P-3306-8-CCT-L
38331-5608	P-3308-CCT	38331-6008	P-3308-CCT-K	38331-5808	P-3308-CCT-L
38331-5610	P-3310-CCT	38331-6010	P-3310-CCT-K	38331-5810	P-3310-CCT-L
38331-5612	P-3312-CCT	38331-6012	P-3312-CCT-K	38331-5812	P-3312-CCT-L
38331-5615	P-3315-CCT	38331-6015	P-3315-CCT-K	38331-5815	P-3315-CCT-L
38331-5618	P-3318-CCT	38331-6018	P-3318-CCT-K	38331-5818	P-3318-CCT-L
38331-5621	P-3321-CCT	38331-6021	P-3321-CCT-K	38331-5821	P-3321-CCT-L
38331-5624	P-3324-CCT	38331-6024	P-3324-CCT-K	38331-5824	P-3324-CCT-L
38331-5627	P-3327-CCT	38331-6027	P-3327-CCT-K	38331-5827	P-3327-CCT-L
38331-5630	P-3330-CCT	38331-6030	P-3330-CCT-K	38331-5830	P-3330-CCT-L
38331-5633	P-3333-CCT	38331-6033	P-3333-CCT-K	38331-5833	P-3333-CCT-L

SOCKETS

Cable Clamp Top (-CCT)		Cable Clamp Top w/Keeper (-CCT-K)		Cable Clamp Top w/Latch (-CCT-L)	
Order #	Engineering #	Order #	Engineering #	Order #	Engineering #
38331-8002	S-3302-CCT	38331-8402	S-3302-CCT-K	38331-8202	S-3302-CCT-L
38331-8003	S-3303-CCT	38331-8403	S-3303-CCT-K	38331-8203	S-3303-CCT-L
38331-8004	S-3304-CCT	38331-8404	S-3304-CCT-K	38331-8204	S-3304-CCT-L
38331-8006	S-3306-CCT	38331-8406	S-3306-CCT-K	38331-8206	S-3306-CCT-L
38336-8180	S-3306-8-CCT	38336-8184	S-3306-8-CCT-K	38336-8182	S-3306-8-CCT-L
38331-8008	S-3308-CCT	38331-8408	S-3308-CCT-K	38331-8208	S-3308-CCT-L
38331-8010	S-3310-CCT	38331-8410	S-3310-CCT-K	38331-8210	S-3310-CCT-L
38331-8012	S-3312-CCT	38331-8412	S-3312-CCT-K	38331-8212	S-3312-CCT-L
38331-8015	S-3315-CCT	38331-8415	S-3315-CCT-K	38331-8215	S-3315-CCT-L
38331-8018	S-3318-CCT	38331-8418	S-3318-CCT-K	38331-8218	S-3318-CCT-L
38331-8021	S-3321-CCT	38331-8421	S-3321-CCT-K	38331-8221	S-3321-CCT-L
38331-8024	S-3324-CCT	38331-8424	S-3324-CCT-K	38331-8224	S-3324-CCT-L
38331-8027	S-3327-CCT	38331-8427	S-3327-CCT-K	38331-8227	S-3327-CCT-L
38331-8030	S-3330-CCT	38331-8430	S-3330-CCT-K	38331-8230	S-3330-CCT-L
38331-8033	S-3333-CCT	38331-8433	S-3333-CCT-K	38331-8233	S-3333-CCT-L



Beau™ Power Connectors Cable Mount Plugs and Sockets

FEATURES AND SPECIFICATIONS

Features and Benefits

- Sizes 3 to 33 circuits
- Robust blade contacts resist damage from improper mating
- Large surface area of dual wipe female contact produces maximum current capacity
- No de-rating required. All circuits rated for full current load
- Extra long pre-grounding contact engages before any other contacts for greater safety.

Electrical

Voltage: 250V
Maximum Current: 10 Amp

Mechanical

Operating Temperature: 110°C

Physical

Base Insulator: High-grade phenolic, black
Plug Contact: Brass
Plug Contact Plating: Tin
Socket Contact: Phosphor bronze
Socket Contact Plating: Tin
Pre-grounding Contact: Heavy-duty plated brass

38330, 38336

Flared Hole End (FHE)



Reference Information

UL: File E34763
CSA: File 22156

CONTACT TAILS

Molex offers a wide selection of contact tails. Consult factory for availability and part numbers of other styles

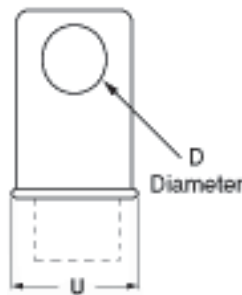
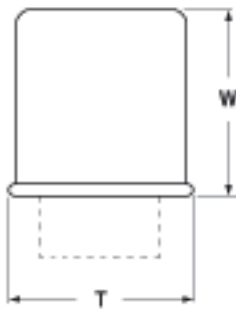

P Solder Eye (Standard)

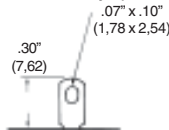

P₁ Printed Circuit and Wire Wrap, Short

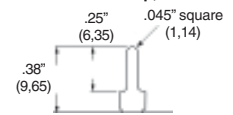

S₁ Quick Connect

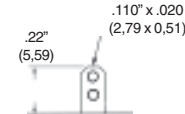

P₁ Quick Connect

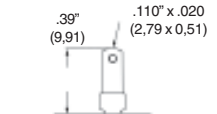

S Solder Eye (Standard)

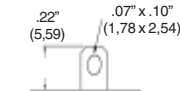

S₂ Printed Circuit

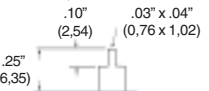

P₁ Wire Wrap, Long

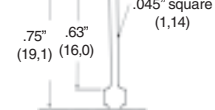

Contact Orientation

The polarization arrangement numbers shown below are for sockets, as viewed from the wiring side. Plug numbering is the opposite. A heavy-duty polarizing/ground contact is in position 14 for Nos. 3324, 3327, 3330 and in position 17 for No. 3333.



38330-XX03



38330-XX04



38330-XX06



38336-8XX0



38330-XX08



38330-XX10

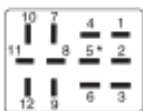

38330-XX12



38330-XX15 to 38330-XX21



38330-XX24 to 38330-XX30



38330-XX33

* Indicates location of pre-grounding contact. † Pre-grounding contact is standard

ORDERING INFORMATION AND DIMENSIONS



Beau™ Power Connectors
Cable Mount Plugs and Sockets

38330, 38336

Part#	D		T		U		W		X	
	in	mm	in	mm	in	mm	in	mm	in	mm
3303	.31	7.9	1.00	25.4	.44	11.1	.97	24,6	.50	12.7
3304	.38	9.5	.75	25.4	.69	17.5	.97	24,6	.50	12.7
3306	.44	11.1	1.00	25.4	.69	17.5	1.06	27,0	.50	12.7-
3306-8	.44	11.1	1.00	25.4	.69	17.5	1.06	27,0	.50	12.7
3308	.50	12.7	1.25	31.8	.69	17.5	1.06	27,0	.50	12.7
3310	.50	12.7	1.56	39.7	.69	17.5	1.19	30,2	.50	12.7
3312	.56	14.3	1.25	31.8	.94	23.8	1.19	30,2	.50	12.7
3315	.56	14.3	1.78	45.2	1.16	29.4	1.75	44,5	.75	19.1
3318	.56	14.3	2.08	52.8	1.16	29.4	1.75	44,5	.75	19.1
3321	.63	15.9	2.34	59.5	1.16	29.4	1.75	44,5	.75	19.1
3324	.63	15.9	2.78	70.6	1.16	29.4	1.75	44,5	.75	19.1
3327	.63	15.9	3.00	76.2	1.16	29.4	1.75	44,5	.75	19.1
3330	.75	19.0	3.34	84.9	1.16	29.4	1.75	44,5	.75	19.1
3333	.75	19.0	3.66	92.9	1.16	29.4	1.75	44,5	.75	19.1

PLUGS		SOCKETS	
Flared Hole End (FHE)		Flared End Hole (FHE)	
Order #	Engineering #	Order #	Engineering #
38330-8503	P-3303-FHE	38330-9303	S-3303-FHE
38330-8504	P-3304-FHE	38330-9304	S-3304-FHE
38330-8506	P-3306-FHE	38330-9306	S-3306-FHE
38336-8085	P-3306-8-FHE	38336-8093	S-3306-8-FHE
38330-8508	P-3308-FHE	38330-9308	S-3308-FHE
38330-8510	P-3310-FHE	38330-9310	S-3310-FHE
38330-8512	P-3312-FHE	38330-9312	S-3312-FHE
38330-8515	P-3315-FHE	38330-9315	S-3315-FHE
38330-8518	P-3318-FHE	38330-9318	S-3318-FHE
38330-8521	P-3321-FHE	38330-9321	S-3321-FHE
38330-8524	P-3324-FHE	38330-9324	S-3324-FHE
38330-8527	P-3327-FHE	38330-9327	S-3327-FHE
38330-8530	P-3330-FHE	38330-9330	S-3330-FHE
38330-8533	P-3333-FHE	38330-9333	S-3333-FHE



Beau™ Power Connectors Cable Mount Plugs and Sockets

FEATURES AND SPECIFICATIONS

Features and Benefits

- Sizes 2 to 33 circuits
- Robust blade contacts resist damage from improper mating
- Large surface area of dual wipe female contact produces maximum current capacity
- No de-rating required. All circuits rated for full current load
- Extra long pre-grounding contact engages before any other contacts for greater safety.

Electrical

Voltage: 250V
Maximum Current: 10 Amp

Mechanical

Operating Temperature: 110°C

Physical

Base Insulator: High-grade phenolic, black
Plug Contact: Brass
Plug Contact Plating: Tin
Socket Contact: Phosphor bronze
Socket Contact Plating: Tin
Pre-grounding Contact: Heavy-duty plated brass

38330, 38331, 38336
Flared Hole Top (FHT)



Reference Information

UL: File E34763
CSA: File 22156

CONTACT TAILS

Molex offers a wide selection of contact tails. Consult factory for availability and part numbers of other styles

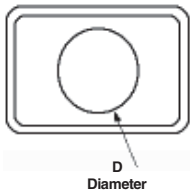

P Solder Eye (Standard)

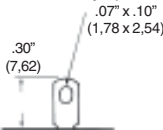

P₁ Printed Circuit and Wire Wrap, Short

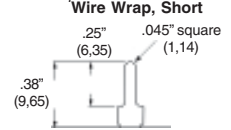

S₁ Quick Connect

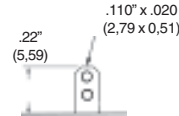

P₁ Quick Connect

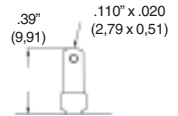

S Solder Eye (Standard)

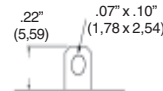

S₂ Printed Circuit

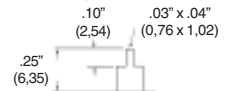

P₂ Wire Wrap, Long

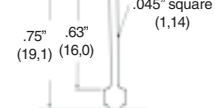

Contact Orientation

The polarization arrangement numbers shown below are for sockets, as viewed from the wiring side. Plug numbering is the opposite. A heavy-duty polarizing/ground contact is in position 14 for Nos. 3324, 3327, 3330 and in position 17 for No. 3333.



38330-XX03



38330-XX04



38330-XX06



38336-8XX0



38330-XX08



38330-XX10

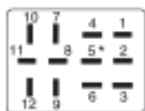

38330-XX12



38330-XX15 to 38330-XX21



38330-XX24 to 38330-XX30



38330-XX33

* Indicates location of pre-grounding contact. † Pre-grounding contact is standard



38330, 38331, 38336

Part#	D		T		U		W	
	in	mm	in	mm	in	mm	in	mm
3302*	.38	9.5	.66	16.7	–	–	.97	24.6
3303	.31	7.9	1.00	25.4	.44	11.1	.97	24.6
3304	.38	9.5	.75	25.4	.69	17.5	.97	24.6
3306	.44	11.1	1.00	25.4	.69	17.5	1.06	27.0
3306-8	.44	11.1	1.00	25.4	.69	17.5	1.06	27.0
3308	.50	12.7	1.25	31.8	.69	17.5	1.06	27.0
3310	.50	12.7	1.56	39.7	.69	17.5	1.19	30.2
3312	.56	14.3	1.25	31.8	.94	23.8	1.19	30.2
3315	.56	14.3	1.78	45.2	1.16	29.4	1.75	44.5
3318	.56	14.3	2.08	52.8	1.16	29.4	1.75	44.5
3321	.63	15.9	2.34	59.5	1.16	29.4	1.75	44.5
3324	.63	15.9	2.78	70.6	1.16	29.4	1.75	44.5
3327	.63	15.9	3.00	76.2	1.16	29.4	1.75	44.5
3330	.75	19.0	3.34	84.9	1.16	29.4	1.75	44.5
3333	.75	19.0	3.66	92.9	1.16	29.4	1.75	44.5

PLUGS		SOCKETS	
Flared Hole Top (FHT)		Flared Hole Top (FHT)	
Order #	Engineering #	Order #	Engineering #
38330-9902	P-3302-FHT	38331-0802	S-3302-FHT
38330-9903	P-3303-FHT	38331-0803	S-3303-FHT
38330-9904	P-3304-FH	38331-0804	S-3304-FHT
38330-9906	P-3306-FHT	38331-0806	S-3306-FHT
38336-8099	P-3306-8-FHT	38336-8108	S-3306-8-FHT
38330-9908	P-3308-FHT	38331-0808	S-3308-FHT
38330-9910	P-3310-FHT	38331-0810	S-3310-FHT
38330-9912	P-3312-FHT	38331-0812	S-3312-FHT
38330-9915	P-3315-FHT	38331-0815	S-3315-FHT
38330-9918	P-3318-FHT	38331-0818	S-3318-FHT
38330-9921	P-3321-FHT	38331-0821	S-3321-FHT
38330-9924	P-3324-FHT	38331-0824	S-3324-FHT
38330-9927	P-3327-FHT	38331-0827	S-3327-FHT
38330-9930	P-3330-FHT	38331-0830	S-3330-FHT
38330-9933	P-3333-FHT	38331-0833	S-3333-FHT



Beau™ Power Connectors Panel Mount Plugs and Sockets

FEATURES AND SPECIFICATIONS

Features and Benefits

- Sizes 4 to 16 circuits
- Robust blade contacts resist damage from improper mating
- Large surface area of dual wipe female contact produces maximum current capacity
- No de-rating required. All circuits rated for full current load
- Extra long pre-grounding contact engages before any other contacts for greater safety.

Electrical

Voltage: 250V
Maximum Current: 15 Amp

Mechanical

Operating Temperature: 150°C

Physical

Base Insulator: High-grade phenolic, black
Plug Contact: Brass
Plug Contact Plating: Tin
Socket Contact: Phosphor bronze
Socket Contact Plating: Tin
Pre-grounding Contact: Heavy-duty plated brass

38540

Angle Bracket (AB)
Angle Bracket Tapped (ABT)
Less Angle Bracket (LAB)



Reference Information

UL : File E34763
CSA: File 22156

SUGGESTED PANEL MOUNTING DIMENSIONS

CONTACT TAILS

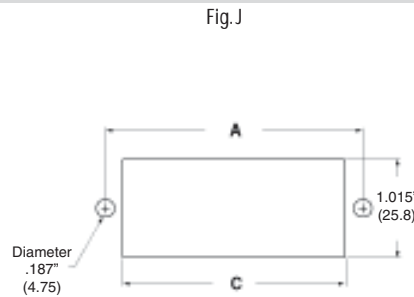
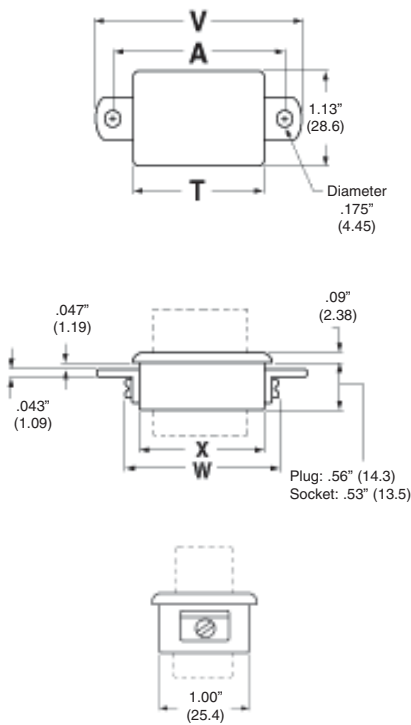

Molex offers a wide selection of contact tails. Consult factory for availability and part numbers of other styles

P Solder Hook (Standard)



P₃ Solder Eye, large

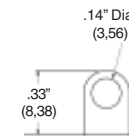

S₃ Solder Eye, large

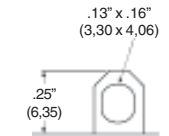

P₁ Quick Connect

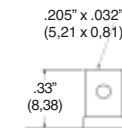

P₆ Printed Circuit

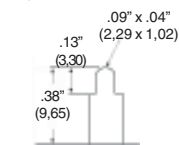

S₆ Printed Circuit

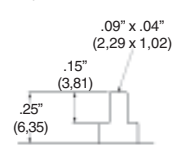

P₂ Quick Connect

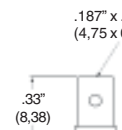

S₁ Solder Eye & Quick Connect (Standard)

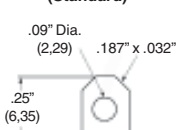

S₅ Solder Eye, extra large & quick connect

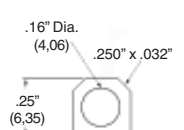

Contact Orientation

The polarization arrangement numbers shown below are for sockets, as viewed from the wiring side. Plug numbering is the opposite.

○ Polarizing position

◐ Combination pre-grounding/polarizing position

● Polarizing position - Current carrying contacts



38540-XX04

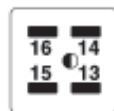

38540-XX05

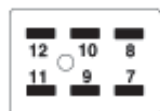

38540-XX06

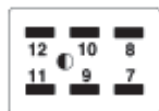

38540-XX07

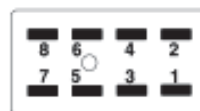

38540-XX08



38540-XX09

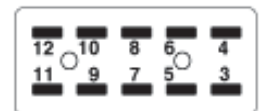

38540-XX10

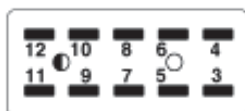

38540-XX011



38540-XX12



38540-XX08

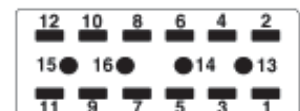

38540-XX14, 38540-XX15, 38540-XX16



38540

Part#	T		V		W		X	
	in	mm	in	mm	in	mm	in	mm
5404/05	1.13	28.6	2.02	51.2	1.23	31.4	1.00	25.4
5406/07	1.56	39.7	2.45	62.3	1.67	42.5	1.44	36.5
5408/09	2.00	50.8	2.89	73.4	2.11	53.6	1.88	47.6
5410/11	2.44	61.9	3.33	84.5	2.55	64.7	2.31	58.7
5412/13	2.88	73.0	3.77	95.6	2.98	75.8	2.75	69.9
5414	2.88	73.0	3.77	95.6	2.98	75.8	2.75	69.9
5415	2.88	73.0	3.77	95.6	2.98	75.8	2.75	69.9
5416	2.88	73.0	3.77	95.6	2.98	75.8	2.75	69.9

Part #	Fig.#	A		C	
		in	mm	in	mm
5404/05	J	1.594	40.5	1.015	25.8
5406/07	J	2.031	51.6	1.453	36.9
5408/09	J	2.468	62.7	1.891	48.0
5410/11	J	2.906	73.8	2.328	59.1
5412/13	J	3.344	84.9	2.766	70.3
5414	J	3.344	84.9	2.766	70.3
5415	J	3.344	84.9	2.766	70.3
5416	J	3.344	84.9	2.766	70.3

PLUGS					
Angle Bracket (-AB)		Angle Bracket Tapped (-ABT)		Less Angle Bracket (-LAB)	
Order #	Engineering #	Order #	Engineering #	Order #	Engineering #
38540-0104	P-5404-AB	38540-1004	P-5404-ABT	38540-1904	P-5404-LAB
38540-0105	P-5405-AB	38540-1005	P-5405-ABT	38540-1905	P-5405-LAB
38540-0106	P-5406-AB	38540-1006	P-5406-ABT	38540-1906	P-5406-LAB
38540-0107	P-5407-AB	38540-1007	P-5407-ABT	38540-1907	P-5407-LAB
38540-0108	P-5408-AB	38540-1008	P-5408-ABT	38540-1908	P-5408-LAB
38540-0109	P-5409-AB	38540-1009	P-5409-ABT	38540-1909	P-5409-LAB
38540-0110	P-5410-AB	38540-1010	P-5410-ABT	38540-1910	P-5410-LAB
38540-0111	P-5411-AB	38540-1011	P-5411-ABT	38540-1911	P-5411-LAB
38540-0112	P-5412-AB	38540-1012	P-5412-ABT	38540-1912	P-5412-LAB
38540-0113	P-5413-AB	38540-1013	P-5413-ABT	38540-1913	P-5413-LAB
38540-0114	P-5414-AB	38540-1014	P-5414-ABT	38540-1914	P-5414-LAB
38540-0115	P-5415-AB	38540-1015	P-5415-ABT	38540-1915	P-5415-LAB
38540-0116	P-5416-AB	38540-1016	P-5416-ABT	38540-1916	P-5416-LAB
SOCKETS					
Angle Bracket (-AB)		Angle Bracket Tapped (-ABT)		Less Angle Bracket (-LAB)	
Order #	Engineering #	Order #	Engineering #	Order #	Engineering #
38540-0604	S-5404-AB	38540-1504	S-5404-ABT	38540-2404	S-5404-LAB
38540-0605	S-5405-AB	38540-1505	S-5405-ABT	38540-2405	S-5405-LAB
38540-0606	S-5406-AB	38540-1506	S-5406-ABT	38540-2406	S-5406-LAB
38540-0607	S-5407-AB	38540-1507	S-5407-ABT	38540-2407	S-5407-LAB
38540-0608	S-5408-AB	38540-1508	S-5408-ABT	38540-2408	S-5408-LAB
38540-0609	S-5409-AB	38540-1509	S-5409-ABT	38540-2409	S-5409-LAB
38540-0610	S-5410-AB	38540-1510	S-5410-ABT	38540-2410	S-5410-LAB
38540-0611	S-5411-AB	38540-1511	S-5411-ABT	38540-2411	S-5411-LAB
38540-0612	S-5412-AB	38540-1512	S-5412-ABT	38540-2412	S-5412-LAB
38540-0613	S-5413-AB	38540-1513	S-5413-ABT	38540-2413	S-5413-LAB
38540-0614	S-5414-AB	38540-1514	S-5414-ABT	38540-2414	S-5414-LAB
38540-0615	S-5415-AB	38540-1515	S-5415-ABT	38540-2415	S-5415-LAB
38540-0616	S-5416-AB	38540-1516	S-5416-ABT	38540-2416	S-5416-LAB



Beau™ Power Connectors Panel Mount Plugs and Sockets

FEATURES AND SPECIFICATIONS

Features and Benefits

- Sizes 4 to 16 circuits
- Robust blade contacts resist damage from improper mating
- Large surface area of dual wipe female contact produces maximum current capacity
- No de-rating required. All circuits rated for full current load
- Extra long pre-grounding contact engages before any other contacts for greater safety.

Electrical

Voltage: 250V
Maximum Current: 15 Amp

Mechanical

Operating Temperature: 150°C

Physical

Base Insulator: High-grade phenolic, black
Plug Contact: Brass
Plug Contact Plating: Tin
Socket Contact: Phosphor bronze
Socket Contact Plating: Tin
Pre-grounding Contact: Heavy-duty plated brass

38542

Shallow Bracket (SB)

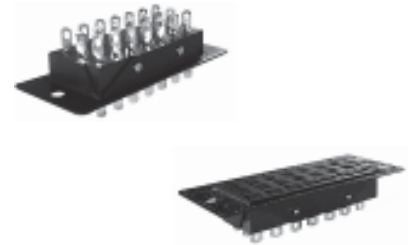

Reference Information

UL : File E34763
CSA: File 22156

SUGGESTED PANEL MOUNTING DIMENSIONS

CONTACT TAILS

Fig. L

Molex offers a wide selection of contact tails. Consult factory for availability and part numbers of other styles

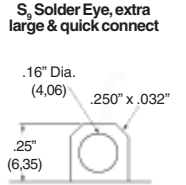
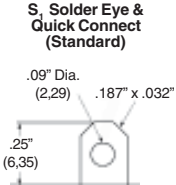
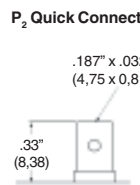
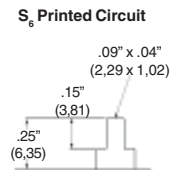
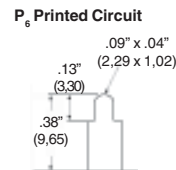
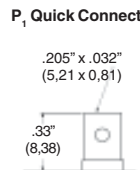
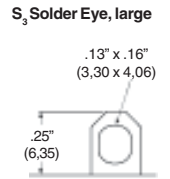
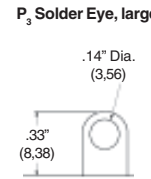
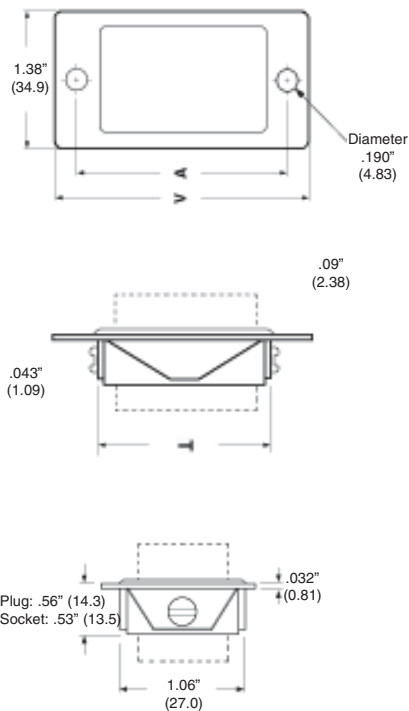

Contact Orientation

The polarization arrangement numbers shown below are for sockets, as viewed from the wiring side. Plug numbering is the opposite.

○ Polarizing position

◐ Combination pre-grounding/polarizing position

● Polarizing position - Current carrying contacts

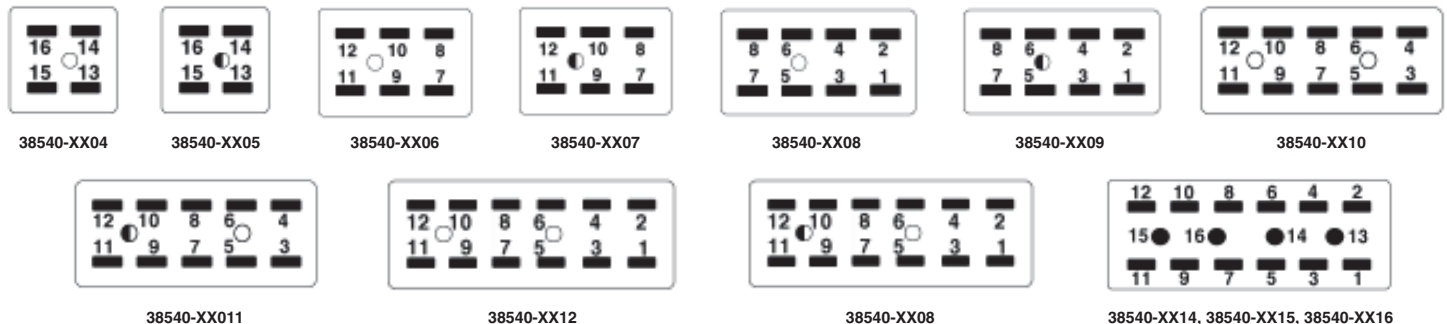



38542

Part#	V		W	
	in	mm	in	mm
5404/05	1.92	48.8	1.16	29.4
5406/07	2.36	59.9	1.59	40.5
5408/09	2.80	71.0	2.03	51.6
5410/11	3.23	82.2	2.47	62.7
5412/13	3.67	93.3	2.91	73.8
5414	3.67	93.3	2.91	73.8
5415	3.67	93.3	2.91	73.8
5416	3.67	93.3	2.91	73.8

Part#	Fig.#	A		C	
		in	mm	in	mm
5404/05	L	1.500	38.1	1.250	31.8
5406/07	L	1.937	49.2	1.687	42.8
5408/09	L	2.375	60.3	2.125	54.0
5410/11	L	2.812	71.4	2.562	65.1
5412/13	L	3.250	82.6	3.000	76.2
5414	L	3.250	82.6	3.000	76.2
5415	L	3.250	82.6	3.000	76.2
5416	L	3.250	82.6	3.000	76.2

PLUGS		SOCKETS	
Shallow Bracket (-SB)		Shallow Bracket (SB)	
Order #	Engineering #	Order #	Engineering #
38542-0804	P-5404-SB	38542-1304	S-5404-SB
38542-0805	P-5405-SB	38542-1305	S-5405-SB
38542-0806	P-5406-SB	38542-1306	S-5406-SB
38542-0807	P-5407-SB	38542-1307	S-5407-SB
38542-0808	P-5408-SB	38542-1308	S-5408-SB
38542-0809	P-5409-SB	38542-1309	S-5409-SB
38542-0810	P-5410-SB	38542-1310	S-5410-SB
38542-0811	P-5411-SB	38542-1311	S-5411-SB
38542-0812	P-5412-SB	38542-1312	S-5412-SB
38542-0813	P-5413-SB	38542-1313	S-5413-SB
38542-0814	P-5414-SB	38542-1314	S-5414-SB
38520-0815	P-5415-SB	38520-1315	S-5415-SB
38542-0816	P-5416-SB	38542-1316	S-5416-SB



Beau™ Power Connectors Panel Mount Plugs and Sockets

FEATURES AND SPECIFICATIONS

Features and Benefits

- Sizes 4 to 16 circuits
- Robust blade contacts resist damage from improper mating
- Large surface area of dual wipe female contact produces maximum current capacity
- No de-rating required. All circuits rated for full current load
- Extra long pre-grounding contact engages before any other contacts for greater safety.

Electrical

Voltage: 250V
Maximum Current: 15 Amp

Mechanical

Operating Temperature: 150°C

Physical

Base Insulator: High-grade phenolic, black
Plug Contact: Brass
Plug Contact Plating: Tin
Socket Contact: Phosphor bronze
Socket Contact Plating: Tin
Pre-grounding Contact: Heavy-duty plated brass

38540
Deep Bracket (DB)

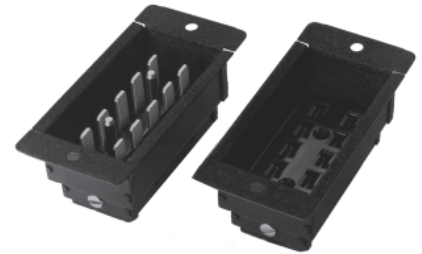

Reference Information

UL : File E34763
CSA: File 22156

SUGGESTED PANEL MOUNTING DIMENSIONS

CONTACT TAILS

Fig. M

Molex offers a wide selection of contact tails. Consult factory for availability and part numbers of other styles

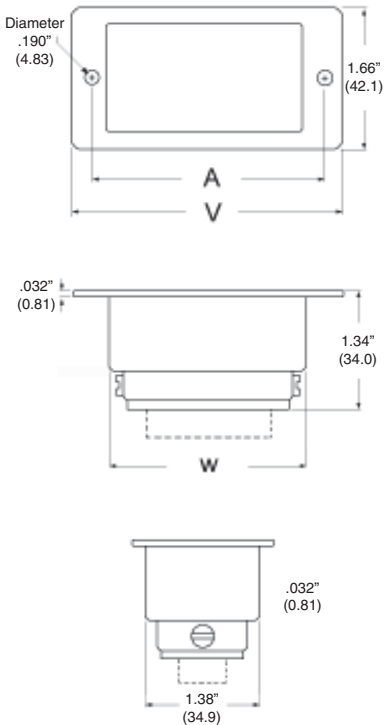

P Solder Hook (Standard)



P₃ Solder Eye, large

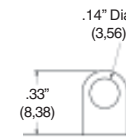

S₃ Solder Eye, large

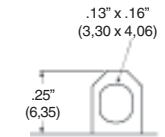

P₁ Quick Connect

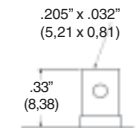

P₆ Printed Circuit

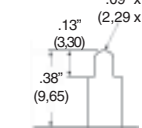

S₆ Printed Circuit

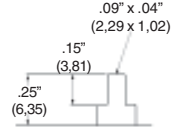

P₂ Quick Connect

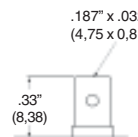

S₁ Solder Eye & Quick Connect (Standard)

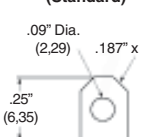

S₅ Solder Eye, extra large & quick connect

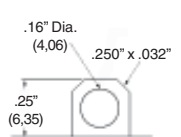

Contact Orientation

The polarization arrangement numbers shown below are for sockets, as viewed from the wiring side. Plug numbering is the opposite.

○ Polarizing position

◐ Combination pre-grounding/polarizing position

● Polarizing position - Current carrying contacts



38540-XX04

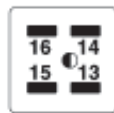

38540-XX05

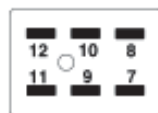

38540-XX06

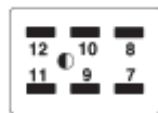

38540-XX07

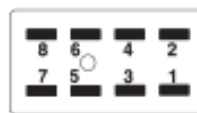

38540-XX08

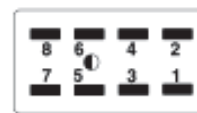

38540-XX09

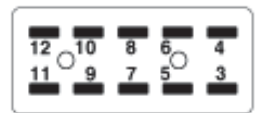

38540-XX10

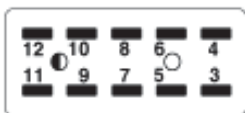

38540-XX011



38540-XX12



38540-XX08

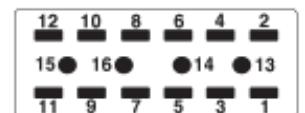

38540-XX14, 38540-XX15, 38540-XX16



38540

Part#	V		W	
	in	mm	in	mm
5404\05	2.19	55.6	1.38	34.9
5406\07	2.63	66.7	1.81	46.0
5408\09	3.06	77.8	2.25	57.2
5410\11	3.50	88.9	2.69	68.3
5412\13	3.94	100	3.13	79.4
5414	3.94	100	3.13	79.4
5415	3.94	100	3.13	79.4
5416	3.94	100	3.13	79.4

Part #	Fig.#	A		C	
		in	mm	in	mm
5404/05	M	1.750	44.5	1.437	36.5
5406/07	M	2.187	55.5	1.875	47.6
5408/09	M	2.625	66.7	2.312	58.7
5410/11	M	3.062	77.8	2.750	69.9
5412/13	M	3.500	88.9	3.187	80.9
5414	M	3.500	88.9	3.187	80.9
5415	M	3.500	88.9	3.187	80.9
5416	M	3.500	88.9	3.187	80.9

PLUGS		SOCKETS	
Deep Bracket (DB)		Deep Bracket (DB)	
Order #	Engineering #	Order #	Engineering #
38540-3704	P-5404-DB	38540-4204	S-5404-DB
38540-3705	P-5405-DB	38540-4205	S-5405-DB
38540-3706	P-5406-DB	38540-4206	S-5406-DB
38540-3707	P-5407-DB	38540-4207	S-5407-DB
38540-3708	P-5408-DB	38540-4208	S-5408-DB
38540-3709	P-5409-DB	38540-4209	S-5409-DB
38540-3710	P-5410-DB	38540-4210	S-5410-DB
38540-3711	P-5411-DB	38540-4211	S-5411-DB
38540-3712	P-5412-DB	38540-4212	S-5412-DB
38540-3713	P-5413-DB	38540-4213	S-5413-DB
38540-3714	P-5414-DB	38540-4214	S-5414-DB
38520-3715	P-5415-DB	38520-4215	S-5415-DB
38540-3716	P-5416-DB	38540-4216	S-5416-DB

FEATURES AND SPECIFICATIONS



Beau™ Power Connectors Cable Mount Plugs and Sockets

Features and Benefits

- Sizes 4 to 16 circuits
- Robust blade contacts resist damage from improper mating
- Large surface area of dual wipe female contact produces maximum current capacity
- No de-rating required. All circuits rated for full current load
- Extra long pre-grounding contact engages before any other contacts for greater safety.
- Strain relief cable clamps, used with round or flat cable

Electrical

Voltage: 250V
Maximum Current: 15 Amp

Mechanical

Operating Temperature: 110°C

Physical

Base Insulator: High-grade phenolic, black
Plug Contact: Brass
Plug Contact Plating: Tin
Socket Contact: Phosphor bronze
Socket Contact Plating: Tin/Lead
Pre-grounding Contact: Heavy-duty plated brass

38541
Cable Clamp End (CCE)



CONTACT TAILS

Molex offers a wide selection of contact tails. Consult factory for availability and part numbers of other styles

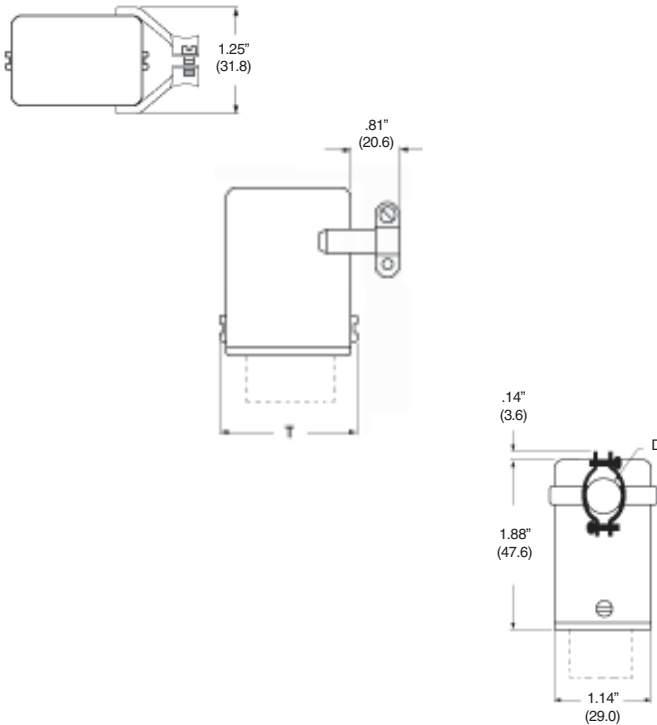

P Solder Hook (Standard)



P₃ Solder Eye, large

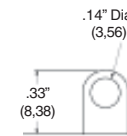

S₃ Solder Eye, large

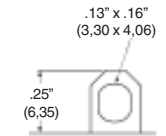

P₁ Quick Connect

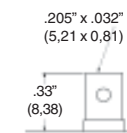

P₆ Printed Circuit

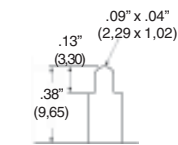

S₆ Printed Circuit

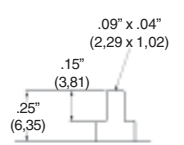

P₂ Quick Connect

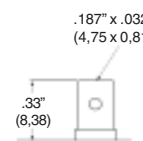

S₁ Solder Eye & Quick Connect (Standard)

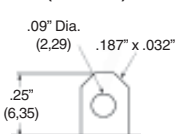

S₂ Solder Eye, extra large & quick connect

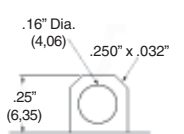

Contact Orientation

The polarization arrangement numbers shown below are for sockets, as viewed from the wiring side. Plug numbering is the opposite.

○ Polarizing position

◐ Combination pre-grounding/polarizing position

● Polarizing position - Current carrying contacts



38540-XX04



38540-XX05

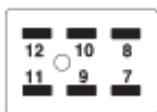

38540-XX06

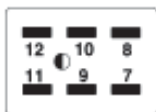

38540-XX07

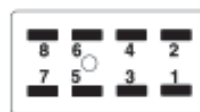

38540-XX08



38540-XX09

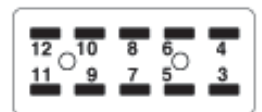

38540-XX10

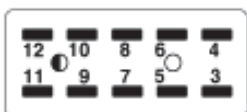

38540-XX011



38540-XX12



38540-XX08

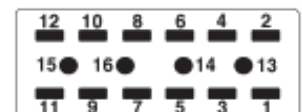

38540-XX14, 38540-XX15, 38540-XX16



38541

DIMENSIONS

Part#	V		W	
	in	mm	in	mm
5404\05	.44	11.1	1.23	31.4
5406\07	.44	11.1	1.67	42.5
5408\09	.56	14.3	2.11	53.6
5410\11	.56	14.3	2.55	64.7
5412\13	.63	15.9	2.98	75.8
5414	.63	15.9	2.98	75.8
5415	.63	15.9	2.98	75.8
5416	.63	15.9	2.98	75.8

For Connector size	Clamp opening dia., in. (mm)		Clamp Number
	min	max	
Standard Clamps Sizes			
38541-XX04 thru 38541-XX07	.38" (9,7)	.72" (18,3)	-
38541-XX08 thru 38541-XX16	.38" (9,7)	.84" (21,3)	-
Clamp Options			
38541-XX04 thru 38541-XX16	.45" (11,4)	.91" (23,1)	78
38541-XX04 thru 38541-XX16 for Mating with Deep Bracket (DB)	.38" (9,7)	.72" (18,3)	47

PLUGS		SOCKETS	
Cable Clamp End (CCE)		Cable Clamp End (CCE)	
Order #	Engineering #	Order #	Engineering #
38541-0004	P-5404-CCE	38541-3004	S-5404-CCE
38541-0005	P-5405-CCE	38541-3005	S-5405-CCE
38541-0006	P-5406-CCE	38541-3006	S-5406-CCE
38541-0007	P-5407-CCE	38541-3007	S-5407-CCE
38541-0008	P-5408-CCE	38541-3008	S-5408-CCE
38541-0009	P-5409-CCE	38541-3009	S-5409-CCE
38541-0010	P-5410-CCE	38541-3010	S-5410-CCE
38541-0011	P-5411-CCE	38541-3011	S-5411-CCE
38541-0012	P-5412-CCE	38541-3012	S-5412-CCE
38541-0013	P-5413-CCE	38541-3013	S-5413-CCE
38541-0014	P-5414-CCE	38541-3014	S-5414-CCE
38521-0015	P-5415-CCE	38521-3015	S-5415-CCE
38541-0016	P-5416-CCE	38541-3016	S-5416-CCE



Beau™ Power Connectors Cable Mount Plugs and Sockets

FEATURES AND SPECIFICATIONS

Features and Benefits

- Sizes 4 to 16 circuits
- Robust blade contacts resist damage from improper mating
- Large surface area of dual wipe female contact produces maximum current capacity
- No de-rating required. All circuits rated for full current load
- Extra long pre-grounding contact engages before any other contacts for greater safety.

Electrical

Voltage: 250V
Maximum Current: 15 Amp

Mechanical

Operating Temperature: 110°C

Physical

Base Insulator: High-grade phenolic, black
Plug Contact: Brass
Plug Contact Plating: Tin
Socket Contact: Phosphor bronze
Socket Contact Plating: Tin
Pre-grounding Contact: Heavy-duty plated brass

38541

Cable Clamp Top (CCT)
Cable Clamp Top w/ Keeper (CCT-K)
Cable Clamp Top w/ Latch (CCT-L)



OPTIONS

CONTACT TAILS

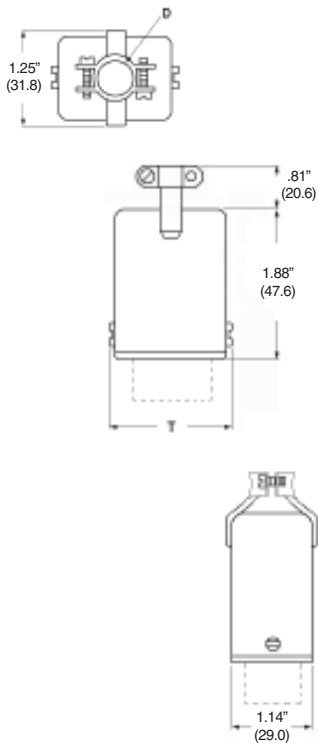

For connecting two cable-mounted connectors, plug and socket can be equipped with either a latch (-L) or keeper (-K)>

Keeper (-K)



Latch (-L)

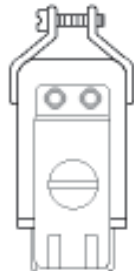

Molex offers a wide selection of contact tails. Consult factory for availability and part numbers of other styles

P Solder Hook (Standard)



P₃ Solder Eye, large

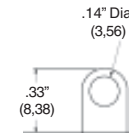

S₃ Solder Eye, large

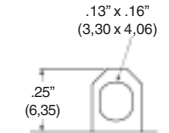

P₁ Quick Connect

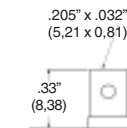

P₆ Printed Circuit

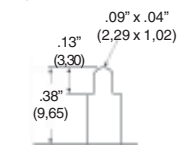

S₆ Printed Circuit

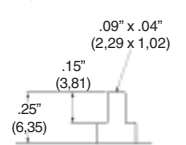

P₂ Quick Connect

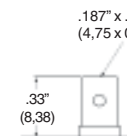

S Solder Eye & Quick Connect (Standard)

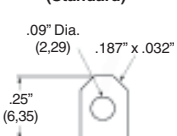

S₆ Solder Eye, extra large & quick connect

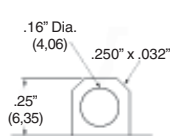

Contact Orientation

The polarization arrangement numbers shown below are for sockets, as viewed from the wiring side. Plug numbering is the opposite.

○ Polarizing position

◐ Combination pre-grounding/polarizing position

● Polarizing position - Current carrying contacts



38540-XX04



38540-XX05

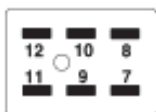

38540-XX06

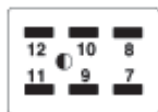

38540-XX07

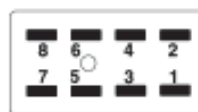

38540-XX08

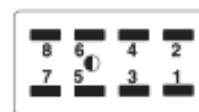

38540-XX09

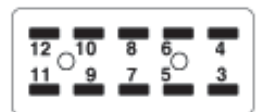

38540-XX10

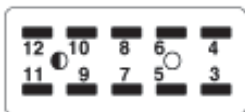

38540-XX011



38540-XX12



38540-XX08

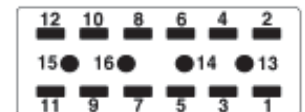

38540-XX14, 38540-XX15, 38540-XX16



38541

Part#	V		W	
	in	mm	in	mm
5404\05	.44	11.1	1.23	31.4
5406\07	.44	11.1	1.67	42.5
5408\09	.56	14.3	2.11	53.6
5410\11	.56	14.3	2.55	64.7
5412\13	.63	15.9	2.98	75.8
5414	.63	15.9	2.98	75.8
5415	.63	15.9	2.98	75.8
5416	.63	15.9	2.98	75.8

For Connector size	Clamp opening dia., in. (mm)		Clamp Number
	min	max	
Standard Clamps Sizes			
38541-XX04 thru 38541-XX07	.38" (9,7)	.72" (18,3)	-
38541-XX08 thru 38541-XX16	.38" (9,7)	.84" (21,3)	-
Clamp Option			
38541-XX04 thru 38541-XX16	.45" (11,4)	.91" (23,1)	78
For non-standard backshell hole size, consult factory			

PLUGS					
Cable Clamp Top (-CCT)		Cable Clamp Top w/Keeper (-CCT-K)		Cable Clamp Top w/Latch (-CCT-L)	
Order #	Engineering #	Order #	Engineering #	Order #	Engineering #
38541-5404	P-5404-CCT	38541-5804	P-5404-CCT-K	38541-5604	P-5404-CCT-L
38541-5405	P-5405-CCT	38541-5805	P-5405-CCT-K	38541-5605	P-5405-CCT-L
38541-5406	P-5406-CCT	38541-5806	P-5406-CCT-K	38541-5606	P-5406-CCT-L
38541-5407	P-5407-CCT	38541-5807	P-5407-CCT-K	38541-5607	P-5407-CCT-L
38541-5408	P-5408-CCT	38541-5808	P-5408-CCT-K	38541-5608	P-5408-CCT-L
38541-5409	P-5409-CCT	38541-5809	P-5409-CCT-K	38541-5609	P-5409-CCT-L
38541-5410	P-5410-CCT	38541-5810	P-5410-CCT-K	38541-5610	P-5410-CCT-L
38541-5411	P-5411-CCT	38541-5811	P-5411-CCT-K	38541-5611	P-5411-CCT-L
38541-5412	P-5412-CCT	38541-5812	P-5412-CCT-K	38541-5612	P-5412-CCT-L
38541-5413	P-5413-CCT	38541-5813	P-5413-CCT-K	38541-5613	P-5413-CCT-L
38541-5414	P-5414-CCT	38541-5814	P-5414-CCT-K	38541-5614	P-5414-CCT-L
38521-5415	P-5415-CCT	38541-5815	P-5415-CCT-K	38541-5615	P-5415-CCT-L
38541-5416	P-5416-CCT	38541-5816	P-5416-CCT-K	38541-5616	P-5416-CCT-L
SOCKETS					
Cable Clamp Top (-CCT)		Cable Clamp Top w/Keeper (-CCT-K)		Cable Clamp Top w/Latch (-CCT-L)	
Order #	Engineering #	Order #	Engineering #	Order #	Engineering #
38541-8404	S-5404-CCT	38541-8804	S-5404-CCT-K	38541-8604	S-5404-CCT-L
38541-8405	S-5405-CCT	38541-8805	S-5405-CCT-K	38541-8605	S-5405-CCT-L
38541-8406	S-5406-CCT	38541-8806	S-5406-CCT-K	38541-8606	S-5406-CCT-L
38541-8407	S-5407-CCT	38541-8807	S-5407-CCT-K	38541-8607	S-5407-CCT-L
38541-8408	S-5408-CCT	38541-8808	S-5408-CCT-K	38541-8608	S-5408-CCT-L
38541-8409	S-5409-CCT	38541-8809	S-5409-CCT-K	38541-8609	S-5409-CCT-L
38541-8410	S-5410-CCT	38541-8810	S-5410-CCT-K	38541-8610	S-5410-CCT-L
38541-8411	S-5411-CCT	38541-8811	S-5411-CCT-K	38541-8611	S-5411-CCT-L
38541-8412	S-5412-CCT	38541-8812	S-5412-CCT-K	38541-8612	S-5412-CCT-L
38541-8413	S-5413-CCT	38541-8813	S-5413-CCT-K	38541-8613	S-5413-CCT-L
38541-8414	S-5414-CCT	38541-8814	S-5414-CCT-K	38541-8614	S-5414-CCT-L
38521-8415	S-5415-CCT	38541-8815	S-5415-CCT-K	38541-8615	S-5415-CCT-L
38541-8416	S-5416-CCT	38541-8816	S-5416-CCT-K	38541-8616	S-5416-CCT-L



Beau™ Power Connectors Cable Mount Plugs and Sockets

FEATURES AND SPECIFICATIONS

Features and Benefits

- Sizes 4 to 16 circuits
- Robust blade contacts resist damage from improper mating
- Large surface area of dual wipe female contact produces maximum current capacity
- No de-rating required. All circuits rated for full current load
- Extra long pre-grounding contact engages before any other contacts for greater safety.

Electrical

Voltage: 250V
Maximum Current: 15 Amp

Mechanical

Operating Temperature: 110°C

Physical

Base Insulator: High-grade phenolic, black
Plug Contact: Brass
Plug Contact Plating: Tin
Socket Contact: Phosphor bronze
Socket Contact Plating: Tin
Pre-grounding Contact: Heavy-duty plated brass

38540

Flared Hole End (FHE)



CONTACT TAILS

Molex offers a wide selection of contact tails. Consult factory for availability and part numbers of other styles

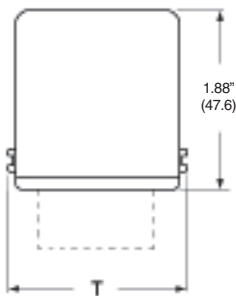

P Solder Hook (Standard)

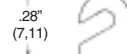

P₃ Solder Eye, large

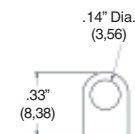

S₃ Solder Eye, large

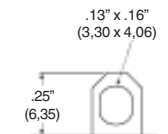

P₁ Quick Connect

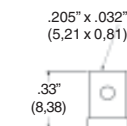

P₆ Printed Circuit

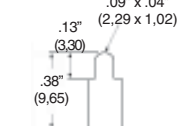

S₆ Printed Circuit

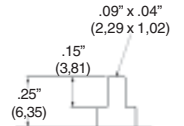

P₂ Quick Connect

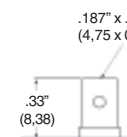

S₁ Solder Eye & Quick Connect (Standard)

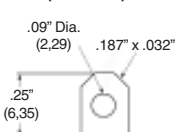

S₂ Solder Eye, extra large & quick connect

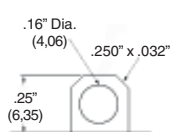

Contact Orientation

The polarization arrangement numbers shown below are for sockets, as viewed from the wiring side. Plug numbering is the opposite.

○ Polarizing position

◐ Combination pre-grounding/polarizing position

● Polarizing position - Current carrying contacts



38540-XX04



38540-XX05

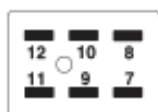

38540-XX06

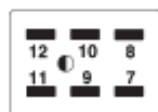

38540-XX07

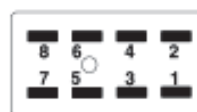

38540-XX08

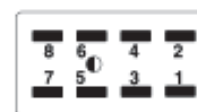

38540-XX09

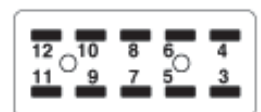

38540-XX10

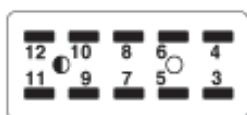

38540-XX011



38540-XX12



38540-XX08

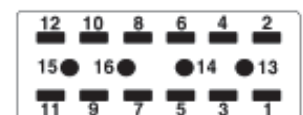

38540-XX14, 38540-XX15, 38540-XX16



38540

Part#	D		T	
	in	mm	in	mm
5404/05	.44	11.1	1.23	31.4
5406/07	.44	11.1	1.67	42.5
5408/09	.56	14.3	2.11	53.6
5410/11	.56	14.3	2.55	64.7
5412	.63	15.9	2.98	75.8

PLUGS		SOCKETS	
Flared Hole End (FHE)		Flared End Hole (FHE)	
Order #	Engineering #	Order #	Engineering #
38540-6404	P-5404-FHE	38540-7404	S-5404-FHE
38540-6405	P-5405-FHE	38540-7405	S-5405-FHE
38540-6406	P-5406-FHE	38540-7406	S-5406-FHE
38540-6407	P-5407-FHE	38540-7407	S-5407-FHE
38540-6408	P-5408-FHE	38540-7408	S-5408-FHE
38540-6409	P-5409-FHE	38540-7409	S-5409-FHE
38540-6410	P-5410-FHE	38540-7410	S-5410-FHE
38540-6411	P-5411-FHE	38540-7411	S-5411-FHE
38540-6412	P-5412-FHE	38540-7412	S-5412-FHE
38540-6413	P-5413-FHE	38540-7413	S-5413-FHE
38540-6414	P-5414-FHE	38540-7414	S-5414-FHE
38540-6415	P-5415-FHE	38540-7415	S-5415-FHE
38540-6416	P-5416-FHE	38540-7416	S-5416-FHE

FEATURES AND SPECIFICATIONS



Beau™ Power Connectors Cable Mount Plugs and Sockets

Features and Benefits

- Sizes 4 to 16 circuits
- Robust blade contacts resist damage from improper mating
- Large surface area of dual wipe female contact produces maximum current capacity
- No de-rating required. All circuits rated for full current load
- Extra long pre-grounding contact engages before any other contacts for greater safety.

Electrical

Voltage: 250V
Maximum Current: 15 Amp

Mechanical

Operating Temperature: 110°C

Physical

Base Insulator: High-grade phenolic, black
Plug Contact: Brass
Plug Contact Plating: Tin
Socket Contact: Phosphor bronze
Socket Contact Plating: Tin/Lead
Pre-grounding Contact: Heavy-duty plated brass

38540

Flared Hole Top (FHT)



CONTACT TAILS

Molex offers a wide selection of contact tails. Consult factory for availability and part numbers of other styles

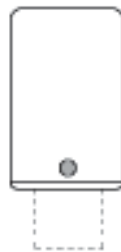
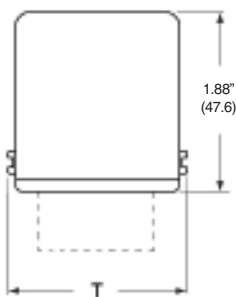
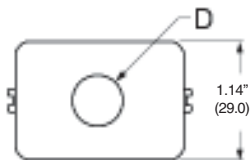

P Solder Hook (Standard)



P₃ Solder Eye, large

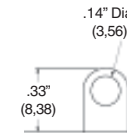

S₃ Solder Eye, large

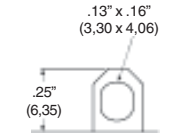

P₁ Quick Connect

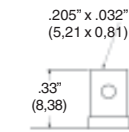

P₆ Printed Circuit

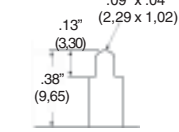

S₆ Printed Circuit

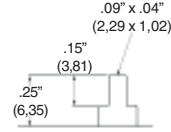

P₂ Quick Connect

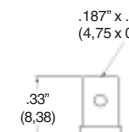

S₂ Solder Eye & Quick Connect (Standard)

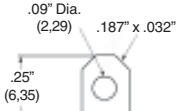

S₅ Solder Eye, extra large & quick connect



Contact Orientation

The polarization arrangement numbers shown below are for sockets, as viewed from the wiring side. Plug numbering is the opposite.

○ Polarizing position

◐ Combination pre-grounding/polarizing position

● Polarizing position - Current carrying contacts



38540-XX04

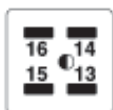

38540-XX05

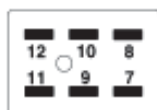

38540-XX06

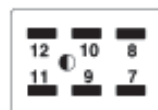

38540-XX07

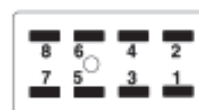

38540-XX08

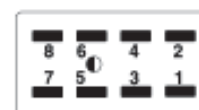

38540-XX09

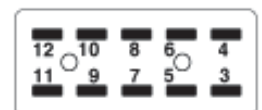

38540-XX10

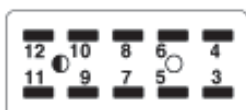

38540-XX011



38540-XX12



38540-XX08

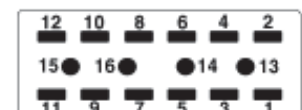

38540-XX14, 38540-XX15, 38540-XX16



38540

Part#	D		T	
	in	mm	in	mm
5404/05	.44	11.1	1.23	31.4
5406/07	.44	11.1	1.67	42.5
5408/09	.56	14.3	2.11	53.6
5410/11	.56	14.3	2.55	64.7
5412	.63	15.9	2.98	75.8

PLUGS		SOCKETS	
Flared Hole Top (FHT)		Flared Hole Top (FHT)	
Order #	Engineering #	Order #	Engineering #
38540-8204	P-5404-FHT	38540-9204	S-5404-FHT
38540-8205	P-5405-FHT	38540-9205	S-5405-FHT
38540-8206	P-5406-FHT	38540-9206	S-5406-FHT
38540-8207	P-5407-FHT	38540-9207	S-5407-FHT
38540-8208	P-5408-FHT	38540-9208	S-5408-FHT
38540-8209	P-5409-FHT	38540-9209	S-5409-FHT
38540-8210	P-5410-FHT	38540-9210	S-5410-FHT
38540-8211	P-5411-FHT	38540-9211	S-5411-FHT
38540-8212	P-5412-FHT	38540-9212	S-5412-FHT
38540-8213	P-5413-FHT	38540-9213	S-5413-FHT
38540-8214	P-5414-FHT	38540-9214	S-5414-FHT
38540-8215	P-5415-FHT	38540-9215	S-5415-FHT
38540-8216	P-5416-FHT	38540-9216	S-5416-FHT