

Type 381LL/383LL, 105 °C Long Life, Snap-In Aluminum

8,000 Hour Snap-in



Type 381LL snap-ins are designed and tested to meet the high ripple current demands of inverter DC link applications where long-life of the capacitor bank is essential to system reliability. The 381LL series uses the most advanced electrolyte system that delivers reliable performance and stability of parameters over the life of the capacitor.

Highlights

- 8,000 life at full rated conditions
- Stable capacitance over operating life
- Reduced leakage current over operating life
- Stable ESR and dissipation factor over operating life
- RoHS Compliant

Specifications

Temperature Range	-55°C to + 105 °C						
Rated Voltage Range	16 Vdc to 250 Vdc						
Capacitance Range	740 µF to 100,000 µF						
Capacitance Tolerance	± 20%						
Leakage Current	≤3 \sqrt{CV} µA, 4 mA max, 5 minutes						
Ripple Current Multipliers	Frequency						
		50Hz	60Hz	120Hz	500Hz	1KHz	20KHz
	0-6 3 Vdc	0.75	0.85	1	1	1.05	1.05
	64-100 Vdc	0.65	0.75	1	1.2	1.2	1.4
	101-250 Vdc	0.65	0.73	1	1.1	1.15	1.2
Low Temperature Characteristics	Ambient Temperature						
		45	60	70	85	105	
	0-63 Vdc	1.9	1.7	1.4	1.25	1	
	64-100 Vdc	1.6	1.5	1.3	1.1	1	
	100-250 Vdc	1.7	1.5	1.3	1.2	1	
Endurance Life Test	Impedance ratio: $Z_{-55^{\circ}\text{C}}/Z_{+25^{\circ}\text{C}}$ ≤8 (16 - 50 Vdc) ≤4 (63 - 100 Vdc) ≤ 3 (150-250 Vdc)						
Endurance Life Test	5000 h at full load at 105 °C Δ Capacitance ± 12.5% ESR 162.5% of limit DCL 100% of limit						
Shelf Life Test	1000 h at 105 °C Δ Capacitance ±20% ESR 200% of limit DCL 100% of limit						
Expected Life	8000 h at full load at 105°C Δ Capacitance ± 20% ESR 200% of limit DCL 100% of limit						
Vibration	10 to 55 Hz, 0.06" and 10 g max, 2 h each plane						
RoHS Compliant							

Type 381LL/383LL, 105 °C Long Life, Snap-In Aluminum

8,000 Hour Snap-in Part Numbering System

381LL/383LL Type 381LL	801 Cap 801 = 800 μ F 832 = 8300 μ F 863 = 86,000 μ F	M Tolerance M = \pm 20%	016 Voltage 016 = 16 Vdc 063 = 63 Vdc 100 = 100 Vdc	A03 Case Code	2 Insulating Sleeve 2 = PET	V V = 5 Pin Standoff
--	---	---	---	-----------------------	---	------------------------------

Outline Drawings

Two Pins

381LL (25 through 40 mm diameter)

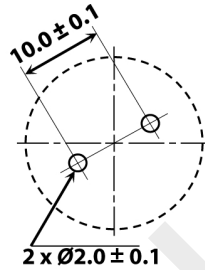
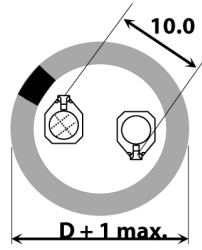
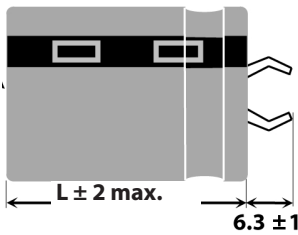

Available in 2, 4 and 5 pins

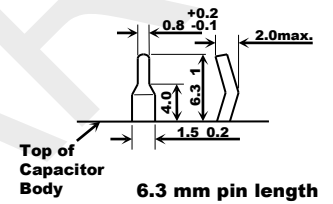

PC Board Mounting Holes

Four Pins

383LL (35, 40 mm diameter)

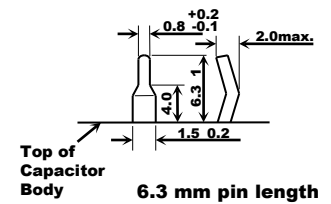
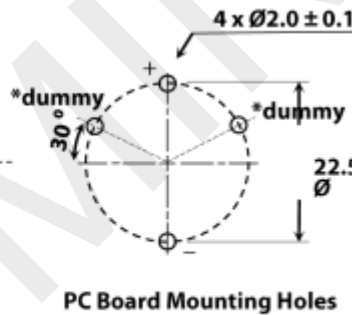
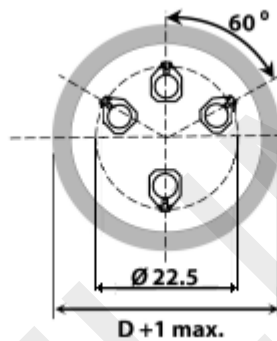
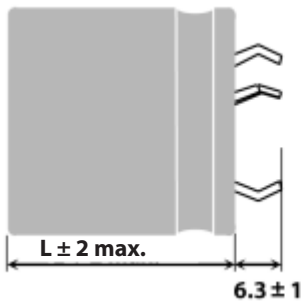

PC Board Mounting Holes

Five Pins

383LL (40 mm diameter)

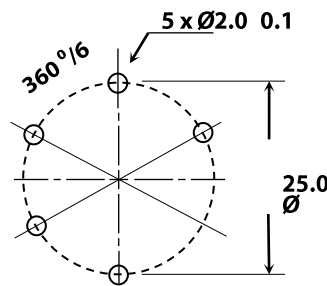
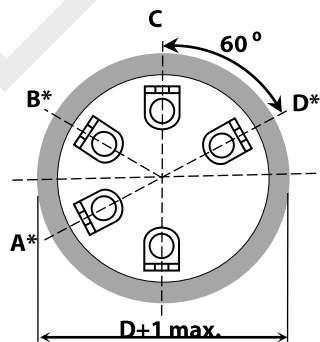
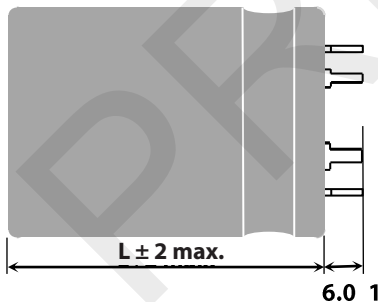

Available in 5 pins

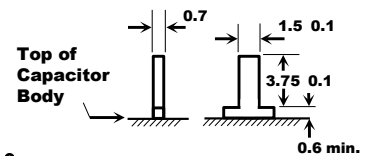

PC Board Mounting Holes

5 pin Standoff pin style (add "V" to end of part#)

Terminal	Connection	
	40 mm Dia.	50 mm Dia.
A	dummy	negative (-)
B	dummy	dummy
C	positive (+)	positive (+)
D	dummy	positive (+)
-	negative (-)	negative (-)

Notes:

* Use dummy terminals for mechanical support only. Make no electrical connection because they resistively connect through the electrolyte to the negative terminal.

** Safety Vent may be on the bottom or on the side of the can.

Type 381LL/383LL, 105 °C Long Life, Snap-In Aluminum

8,000 Hour Snap-in

Ratings

Cap (μ F)	Catalog Part Number	Max ESR		Ripple Amps		Nominal Size
		@ +25°C		@ +105°C		
		120 Hz	20 kHz	120 Hz	20 kHz	D x L
		(ohms)	(ohms)	(A)	(A)	(mm)
16 Vdc (20Vdc Surge)						
35000	381LL353M016A032	0.037	0.036	4.81	5.00	35 x 35
59000	381LL593M016A052	0.022	0.021	6.83	7.10	35 x 50
73000	383LL733M016N052	0.021	0.021	7.60	7.91	40 x 50
75000	381LL753M016A062	0.016	0.015	8.42	8.75	35 x 63
100000	383LL104M016N062	0.016	0.015	9.39	9.77	40 x 63
35 Vdc (44 Vdc Surge)						
6800	381LL682M035A032	0.058	0.056	3.84	3.99	35 x 35
13000	381LL133M035A032	0.042	0.041	4.50	4.68	35 x 35
18000	381LL183M035A052	0.027	0.026	6.09	6.34	35 x 50
22000	381LL223M035A052	0.025	0.024	6.39	6.65	35 x 50
28000	383LL283M035N052	0.024	0.023	7.20	7.48	40 x 50
31000	381LL313M035A062	0.018	0.018	7.90	8.21	35 x 63
38000	383LL383M035N062	0.018	0.017	8.89	9.25	40 x 63
50 Vdc (Vdc Surge)						
6800	381LL682M050A032	0.047	0.046	3.91	4.07	35 x 35
8400	381LL842M050A032	0.041	0.040	4.18	4.35	35 x 35
14000	381LL143M050A052	0.025	0.024	5.94	6.18	35 x 50
17000	383LL173M050N052	0.023	0.022	6.77	7.04	40 x 50
18000	381LL183M050A062	0.018	0.018	7.28	7.58	35 x 63
19000	381LL193M050A062	0.018	0.017	7.34	7.64	35 x 63
24000	383LL243M050N062	0.017	0.016	8.37	8.70	40 x 63
63 Vdc (79 Vdc Surge)						
4700	381LL472M063A032	0.086	0.083	2.91	3.03	35 x 35
6400	381LL642M063A032	0.080	0.078	3.02	3.14	35 x 35
6800	381LL682M063A052	0.050	0.048	4.18	4.35	35 x 50
10000	381LL103M063A052	0.047	0.046	4.28	4.45	35 x 50
13000	383LL133M063N052	0.044	0.043	4.89	5.08	40 x 50
14000	381LL143M063A062	0.035	0.034	5.29	5.50	35 x 63
18000	383LL183M063N062	0.033	0.032	6.04	6.28	40 x 63
80 Vdc (100 Vdc Surge)						
4000	381LL402M080A032	0.084	0.042	3.60	5.04	35 x 35
4700	381LL472M080A052	0.056	0.028	4.80	6.72	35 x 50
6800	381LL682M080A052	0.050	0.025	5.11	7.16	35 x 50
6800	381LL682M080A062	0.040	0.020	6.00	8.39	35 x 63
8400	383LL842M080N052	0.046	0.023	5.86	8.20	40 x 50
9200	381LL922M080A062	0.036	0.018	6.32	8.85	35 x 63
11000	383LL113M080N062	0.034	0.017	7.24	10.13	40 x 63

Type 381LL/383LL, 105 °C Long Life, Snap-In Aluminum

8,000 Hour Snap-in

Cap (μ F)	Catalog Part Number	Max ESR		Ripple Amps		Nominal Size
		@ +25°C		@ +105°C		
		120 Hz	20 kHz	120 Hz	20 kHz	D x L
		(ohms)	(ohms)	(A)	(A)	(mm)
100 Vdc (125 Vdc Surge)						
2400	381LL242M100A032	0.091	0.046	3.46	4.84	35 x35
3300	381LL332M100A052	0.059	0.029	4.70	6.58	35 x50
4100	381LL412M100A052	0.054	0.027	4.91	6.87	35 x 50
4700	381LL472M100A062	0.042	0.021	5.86	8.21	35 x 63
5100	383LL512M100N052	0.050	0.025	5.65	7.91	40 x 50
5600	381LL562M100A062	0.039	0.020	6.07	8.49	35 x 63
6800	383LL682M100N062	0.037	0.018	6.96	9.74	40 x 63
7000	383LL702M100N062	0.037	0.018	6.99	9.78	40 x 63
200 Vdc (250 Vdc Surge)						
950	381LL951M200A032	0.183	0.092	2.30	3.22	35 x 35
1600	381LL162M200A052	0.108	0.054	3.38	4.74	35 x 50
2000	383LL202M200N052	0.101	0.051	3.87	5.42	40 x 50
2200	381LL222M200A062	0.079	0.040	4.19	5.86	35 x 63
2700	383LL272M200N062	0.074	0.037	4.78	6.70	40 x 63
250 Vdc (300 Vdc Surge)						
740	381LL741M250A032	0.200	0.100	2.28	3.19	35 x 35
1200	381LL122M250A052	0.118	0.059	3.24	4.54	35 x 50
1500	383LL152M250N052	0.109	0.055	3.73	5.22	40 x 50
1700	381LL172M250A062	0.087	0.043	4.00	5.60	35 x 63
2100	383LL212M250N062	0.080	0.040	4.61	6.45	40 x 63

Typical Performance Curves

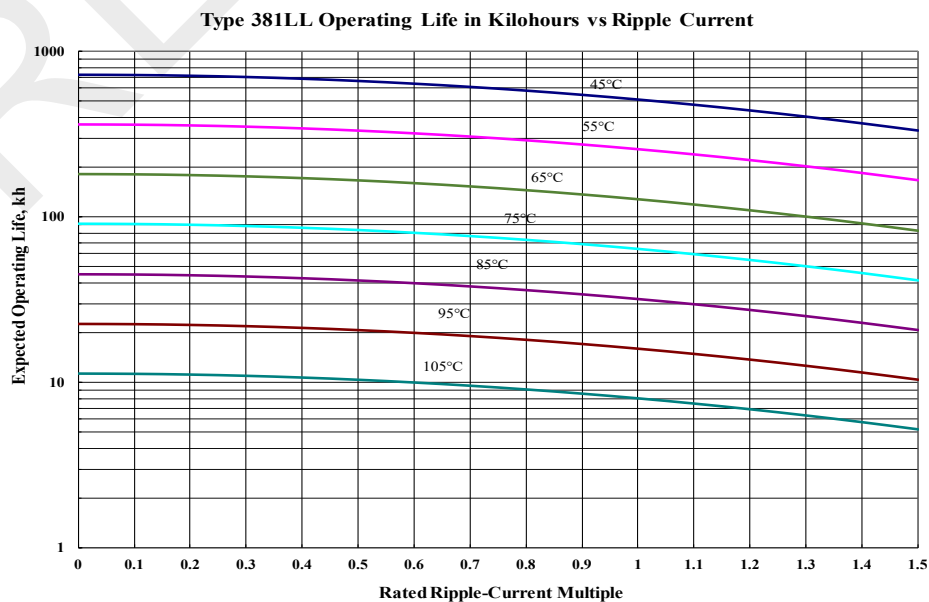

Type 381LL/383LL, 105 °C Long Life, Snap-In Aluminum

8,000 Hour Snap-in

Typical Performance Curves

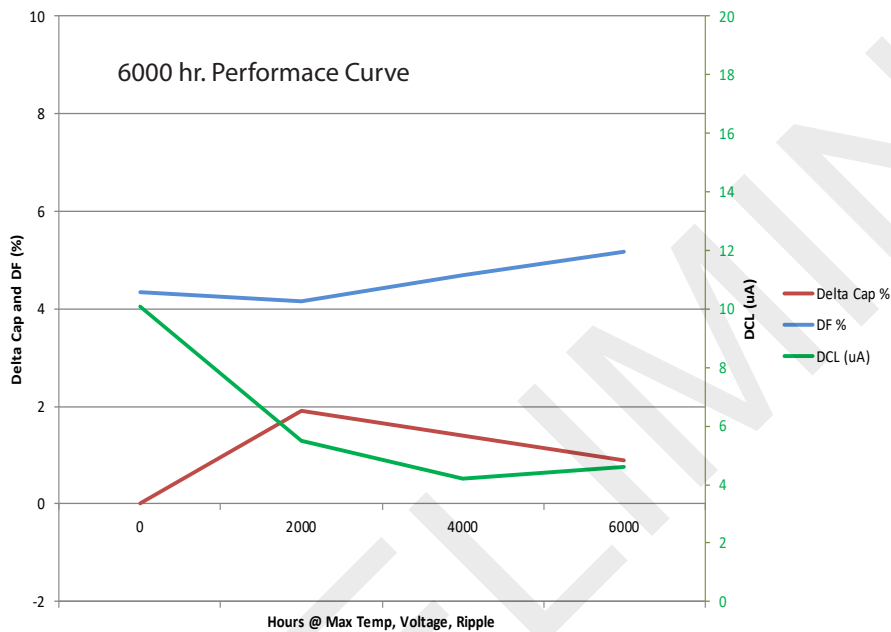
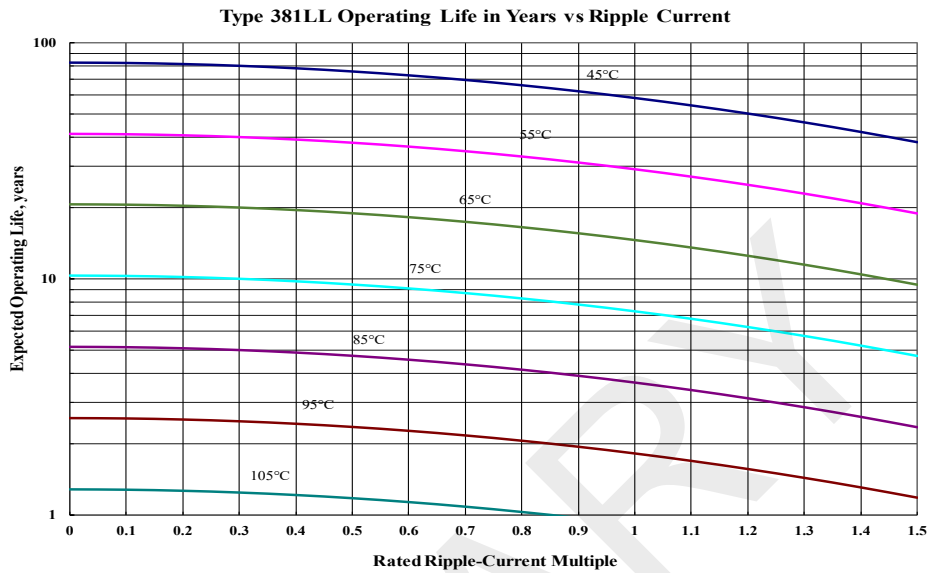

Based on 330uF 250Vdc Endurance Life Test

Notice and Disclaimer: All product drawings, descriptions, specifications, statements, information and data (collectively, the "Information") in this datasheet or other publication are subject to change. The customer is responsible for checking, confirming and verifying the extent to which the Information contained in this datasheet or other publication is applicable to an order at the time the order is placed. All Information given herein is believed to be accurate and reliable, but it is presented without any guarantee, warranty, representation or responsibility of any kind, expressed or implied. Statements of suitability for certain applications are based on the knowledge that the Cornell Dubilier company providing such statements ("Cornell Dubilier") has of operating conditions that such Cornell Dubilier company regards as typical for such applications, but are not intended to constitute any guarantee, warranty or representation regarding any such matter – and Cornell Dubilier specifically and expressly disclaims any guarantee, warranty or representation concerning the suitability for a specific customer application, use, storage, transportation, or operating environment. The Information is intended for use only by customers who have the requisite experience and capability to determine the correct products for their application. Any technical advice inferred from this Information or otherwise provided by Cornell Dubilier with reference to the use of any Cornell Dubilier products is given gratis (unless otherwise specified by Cornell Dubilier), and Cornell Dubilier assumes no obligation or liability for the advice given or results obtained. Although Cornell Dubilier strives to apply the most stringent quality and safety standards regarding the design and manufacturing of its products, in light of the current state of the art, isolated component failures may still occur. Accordingly, customer applications which require a high degree of reliability or safety should employ suitable designs or other safeguards (such as installation of protective circuitry or redundancies or other appropriate protective measures) in order to ensure that the failure of an electrical component does not result in a risk of personal injury or property damage. Although all product-related warnings, cautions and notes must be observed, the customer should not assume that all safety measures are indicated in such warnings, cautions and notes, or that other safety measures may not be required.