

**CONNECTOR  
DESIGNATORS  
A-F-H-L-S  
ROTATABLE  
COUPLING**

**TYPE D INDIVIDUAL  
OR OVERALL  
SHIELD TERMINATION**

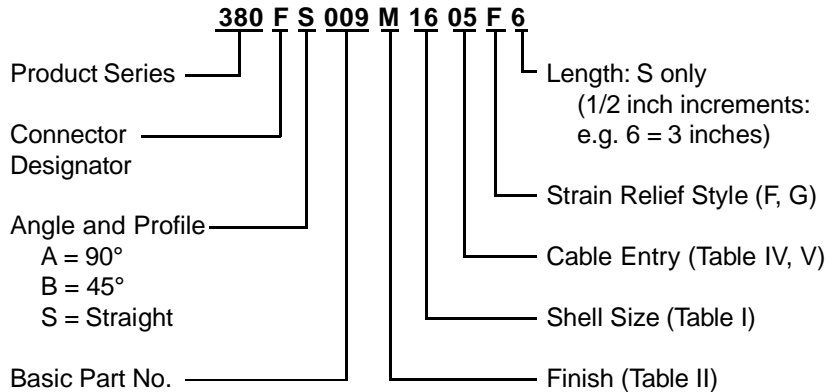

Length  $\pm .060$  (1.52)  
Minimum Order Length 2.0 Inch  
(See Note 4)

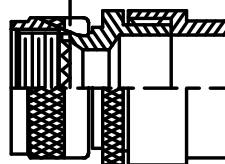

**STYLE 2  
(STRAIGHT  
See Note 1)**

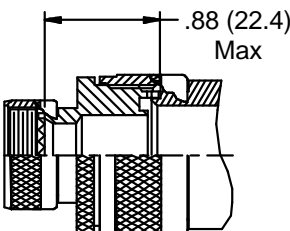
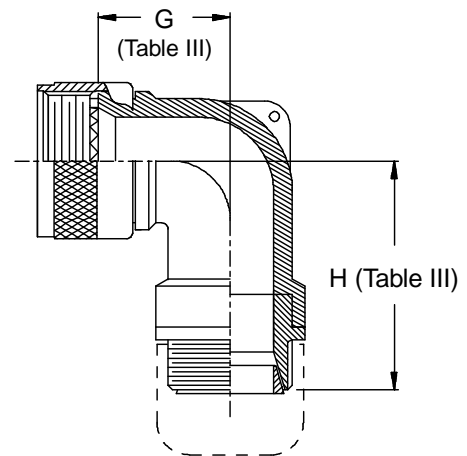
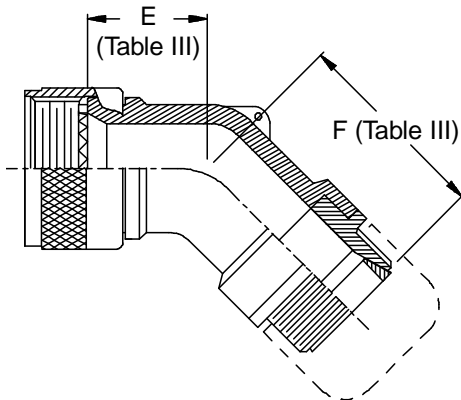
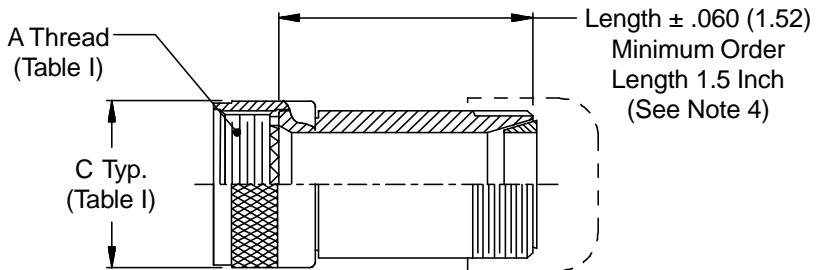

**STYLE 2  
(45° & 90°  
See Note 1)**

**STYLE F  
Light Duty  
(Table IV)**

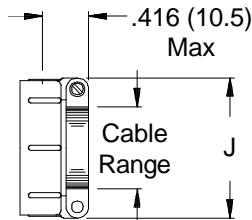

**STYLE G  
Light Duty  
(Table V)**

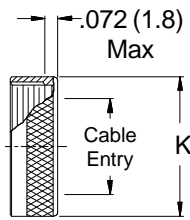

**-445** Now Available with the "NESTOR"

**Glenair's Non-Detent,  
Spring-Loaded, Self-  
Locking Coupling.  
Add "-445" to Specify  
This AS85049 Style "N"  
Coupling Interface.**

**380-009**  
**EMI/RFI Non-Environmental Backshell**  
**with Strain Relief**  
**Type D - Rotatable Coupling - Low Profile**



See inside back cover fold-out or pages 13 and 14 for unabridged Tables I and II.

TABLE III: ELBOW DIMENSIONS									
Shell Size		E		F		G		H	
Conn. Desig.	H	Max		Max		Max		Max	
A-F-L-S									
08	09	.457	(11.6)	1.500	(38.1)	.500	(12.7)	1.445	(36.7)
10	11	.520	(13.2)	1.510	(38.4)	.595	(15.1)	1.565	(39.8)
12	13	.582	(14.8)	1.580	(40.1)	.610	(15.5)	1.585	(40.3)
14	15	.645	(16.4)	1.660	(42.2)	.700	(17.8)	1.655	(42.0)
16	17	.738	(18.7)	1.770	(45.0)	.885	(22.5)	1.725	(43.8)
18	19	.926	(23.5)	1.960	(49.8)	.975	(24.8)	1.915	(48.6)
20	21	.926	(23.5)	1.960	(49.8)	.975	(24.8)	1.915	(48.6)
22	23	1.020	(25.9)	2.110	(53.6)	1.125	(28.6)	2.025	(51.4)
24	25	1.020	(25.9)	2.110	(53.6)	1.125	(28.6)	2.025	(51.4)
28		1.145	(29.1)	2.160	(54.9)	1.225	(31.1)	2.195	(55.8)
32		1.207	(30.7)	2.260	(57.4)	1.575	(40.0)	2.445	(62.1)
36		1.238	(31.4)	2.360	(59.9)	1.775	(45.1)	2.445	(62.1)

TABLE II: STANDARD FINISHES	
GLENAIR	
SYMBOL	FINISH
B	Cadmium Plate, Olive Drab
M	Electroless Nickel
NF	Cadmium Plate, Olive Drab Over Electroless Nickel
See Inside Back Cover for Additional Finish Options	

TABLE IV: CABLE ENTRY				
Dash No.	J Max	Cable Range		
		Min	Max	
02	.968 (24.6)	.125 (3.2)	.250 (6.4)	.500 (12.7)
03	1.046 (26.6)	.250 (6.4)	.375 (9.5)	.750 (19.1)
04	1.156 (29.4)	.312 (7.9)	.500 (12.7)	.875 (22.2)
05	1.218 (30.9)	.437 (11.1)	.625 (15.9)	1.000 (25.4)
06	1.343 (34.1)	.562 (14.3)	.750 (19.1)	1.125 (28.6)
07	1.468 (37.3)	.687 (17.4)	.875 (22.2)	1.250 (31.8)
08	1.593 (40.5)	.812 (20.6)	1.000 (25.4)	1.375 (34.9)
10	1.843 (46.8)	1.062 (27.0)	1.250 (31.8)	1.500 (38.1)

TABLE V: CABLE ENTRY			
Dash No.	K Max	Cable Entry	
		Min	Max
01	.656 (16.7)	.125 (3.2)	.250 (6.4)
02	.781 (19.8)	.250 (6.4)	.375 (9.5)
03	.906 (23.0)	.375 (9.5)	.500 (12.7)
04	1.031 (26.2)	.500 (12.7)	.625 (15.9)
05	1.156 (29.4)	.625 (15.9)	.750 (19.1)
06	1.281 (32.5)	.750 (19.1)	.875 (22.2)
07	1.406 (35.7)	.875 (22.2)	1.000 (25.4)
08	1.531 (38.9)	1.000 (25.4)	1.125 (28.6)
09	1.656 (42.1)	1.125 (28.6)	1.250 (31.8)
10	1.781 (45.2)	1.250 (31.8)	1.375 (34.9)

1. When maximum cable entry (page 21) is exceeded, Style 2 will be supplied. Dimensions E, F, G and H will not apply. Please consult factory.
2. Metric dimensions (mm) are indicated in parentheses.
3. Cable range is defined as the accommodations range for the wire bundle or cable. Dimensions shown are not intended for inspection criteria.
4. Consult factory for shorter lengths on straight backshells.