

**PLEASE CHECK WWW.MOLEX.COM FOR LATEST PART INFORMATION**

**Part Number:** [0353120460](#)  
**Status:** **Active**  
**Description:** 2.50mm Pitch Header, Vertical, Shrouded, with Positive Lock, 4 Circuits, PA Polyamide (Nylon) 6/6, Glass-filled, Natural

**Documents:**

<a href="#">3D Model</a>	<a href="#">Packaging Specification PK-35312-013-001 (PDF)</a>
<a href="#">Drawing (PDF)</a>	<a href="#">Packaging Specification PK-35312-014-001 (PDF)</a>
<a href="#">Product Specification PS-35155-002-001 (PDF)</a>	<a href="#">RoHS Certificate of Compliance (PDF)</a>

**Agency Certification**

CSA	LR19980
TUV	E9450420E01
UL	E29179

**General**

Product Family	PCB Headers
Series	<a href="#">35312</a>
Application	Signal, Wire-to-Board
Product Name	N/A
UPC	822348400010

**Physical**

Breakaway	No
Circuits (Loaded)	4
Circuits (maximum)	4
Color - Resin	Natural
Durability (mating cycles max)	30
First Mate / Last Break	No
Flammability	94V-0
Glow-Wire Compliant	No
Guide to Mating Part	No
Keying to Mating Part	None
Lock to Mating Part	Yes
Material - Plating Mating	Tin
Material - Plating Termination	Tin
Material - Resin	Nylon
Net Weight	0.446/g
Number of Rows	1
Orientation	Vertical
PC Tail Length	3.40mm
PCB Locator	No
PCB Retention	None
PCB Thickness - Recommended	1.60mm
Packaging Type	Bag
Pitch - Mating Interface	2.50mm
Pitch - Termination Interface	2.50mm
Plating min - Mating	5.080µm
Plating min - Termination	5.080µm
Polarized to PCB	No
Shrouded	Partial
Stackable	No
Surface Mount Compatible (SMC)	No
Temperature Range - Operating	-40°C to +105°C
Termination Interface: Style	Through Hole

**Electrical**

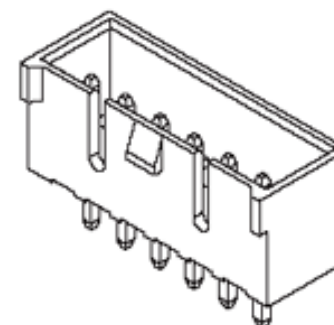

*Series image - Reference only*

**EU ELV**

**Not Relevant**

**EU RoHS**

**Compliant**

**REACH SVHC**

Not Contained Per - ED/30/2017 (7 July 2017)

**Halogen-Free**

**Status**

**Not Low-Halogen**

**Need more information on product environmental compliance?**

Email [productcompliance@molex.com](mailto:productcompliance@molex.com)  
Please visit the [Contact Us](#) section for any non-product compliance questions.

China ROHS

ELV

RoHS Phthalates

Green Image

Not Relevant

Not Contained

**Search Parts in this Series**

[35312](#) Series

**Mates With**

Wire-to-Wire and Wire-to-Board Housing  
[35572](#) Crimp Housing, [35155](#)

Current - Maximum per Contact 3.0A  
Voltage - Maximum 250V

**Material Info**

**Reference - Drawing Numbers**

Packaging Specification PK-35312-013-001, PK-35312-014-001  
Product Specification PS-35155-002-001  
Sales Drawing SD-35312-001, SD-35312-004, SD-35312-005

This document was generated on 08/02/2017

**PLEASE CHECK [WWW.MOLEX.COM](http://WWW.MOLEX.COM) FOR LATEST PART INFORMATION**