

PLEASE CHECK WWW.MOLEX.COM FOR LATEST PART INFORMATION

Part Number: **0351560300**
Status: **Active**
Description: 3.96mm Pitch Wire-to-Board Housing: Positive Locking, 3 Circuits, Natural

Documents:

3D Model	Packaging Specification 351560200-100 (PDF)
Drawing (PDF)	Packaging Specification PK-35156-001-001 (PDF)
Product Specification PS-35156-001-001 (PDF)	RoHS Certificate of Compliance (PDF)
Product Specification PS-35156-003-001 (PDF)	

Agency Certification

CSA	LR19980
UL	E29179

General

Product Family	Crimp Housings
Series	35156
Application	Power, Wire-to-Board
Product Name	N/A
UPC	800754375764

Physical

Breakaway	No
Circuits (maximum)	3
Color - Resin	Natural
Flammability	94V-0
Gender	Receptacle
Glow-Wire Compliant	No
Keying to Mating Part	None
Lock to Mating Part	Yes
Material - Resin	Polyester
Net Weight	0.933/g
Number of Rows	1
Packaging Type	Bag
Panel Mount	No
Pitch - Mating Interface	3.96mm
Pitch - Termination Interface	3.96mm
Stackable	No
Temperature Range - Operating	-40°C to +105°C

Solder Process Data

Lead-freeProcess Capability	N/A
-----------------------------	-----

Material Info

Reference - Drawing Numbers

Packaging Specification	351560200-100, PK-35156-001-001
Product Specification	PS-35156-001-001, PS-35156-003-001
Sales Drawing	SD-35156-**0*

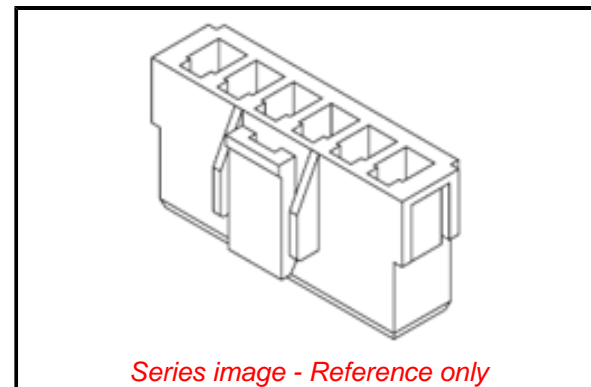

EU ELV

Not Relevant

EU RoHS

Compliant

REACH SVHC

Not Contained Per -
ED/30/2017 (7 July
2017)

Halogen-Free

Status

Not Low-Halogen

**Need more information on product
environmental compliance?**

Email productcompliance@molex.com
Please visit the [Contact Us](#) section for any
non-product compliance questions.

China ROHS	Green Image
ELV	Not Relevant
RoHS Phthalates	Not Contained

Search Parts in this Series

[35156](#) Series

Mates With

[35313](#) PCB Header, [35328](#) PCB Header

Use With

[50217](#) Crimp Terminals