

SUB-MINI & MINIATURE TOGGLES



Fig. 1



Fig. 2



Fig. 3



Fig. 4



Fig. 5



Fig. 6



Fig. 7



Fig. 8



Fig. 9



Fig. 10



Fig. 11



Fig. 12

Sub-Miniature Toggles

Retail Part No.	Bulk Part No.	Figure No.	Circuit Function	Poles/Throws	125VAC/28VDC	AMPS 250VAC	Actuator Style	Actuator Material	Bushing Length	Mounting Hole	Terminal Type	Hardware	Spec. Drawing Page No.
35-000	35-000-BU	1	On Off	SPST	3A	1.5	Bat	BCP	0.220	0.195	Solder	2 N, LR, LW	267-A
35-001	35-001-BU	2	On On	SPDT	3A	1.5	Bat	BCP	0.220	0.195	Solder	2 N, LR, LW	267-A
35-002	35-002-BU	3	On On	DPDT	3A	1.5	Bat	BCP	0.220	0.195	Solder	2 N, LR, LW	267-A

Miniature Toggles

Retail Part No.	Bulk Part No.	Figure No.	Circuit Function	Poles/Throws	125VAC/28VDC	AMPS 250VAC	Actuator Style	Actuator Material	Bushing Length	Mounting Hole	Terminal Type	Hardware	Spec. Drawing Page No.
35-003	35-003-BU	2	On (On)	SPDT	5	2	Bat	BCP	0.350	0.250	Solder	2 N, LR, LW	267-B
35-004	35-004-BU	2	On On	SPDT	5	2	Bat	BCP	0.350	0.250	Solder	2 N, LR, LW	267-B
35-005	35-005-BU	2	On Off On	SPDT	5	2	Bat	BCP	0.350	0.250	Solder	2 N, LR, LW	267-B
35-006	35-006-BU	4	On Off	SPST	5	2	Bat with Boot	BCP	0.350	0.250	Solder	2 N, LR, LW	267-B
35-007	35-007-BU	2	On Off (On)	SPDT	5	2	Bat	BCP	0.350	0.250	Solder	2 N, LR, LW	267-B
35-008	35-008-BU	2	(On) Off (On)	SPDT	5	2	Bat	BCP	0.350	0.250	Solder	2 N, LR, LW	267-B
35-009	35-009-BU	5	On On On	DPDT	5	2	Bat	BCP	0.350	0.250	Solder	2 N, LR, LW	267-C
35-010	35-010-BU	6	On On On	DPDT	5	2	Bat	BCP	0.350	0.250	Solder	2 N, LR, LW	267-E
35-012	35-012-BU	6	On Off On	DPDT	5	2	Bat	BCP	0.350	0.250	Solder	2 N, LR, LW	267-E
35-014	35-014-BU	6	On (On)	DPDT	5	2	Bat	BCP	0.350	0.250	Solder	2 N, LR, LW	267-E
35-016	35-016-BU	6	On Off (On)	DPDT	5	2	Bat	BCP	0.350	0.250	Solder	2 N, LR, LW	267-E
35-018	35-018-BU	6	(On) Off (On)	DPDT	5	2	Bat	BCP	0.350	0.250	Solder	2 N, LR, LW	267-E
35-024	35-024-BU	7	On On	3PDT	5	2	Bat	BCP	0.350	0.250	Solder	2 N, LR, LW	267-D
35-026	35-026-BU	7	On Off On	3PDT	5	2	Bat	BCP	0.350	0.250	Solder	2 N, LR, LW	267-D
35-036	35-036-BU	8	On On	4PDT	5	2	Bat	BCP	0.350	0.250	Solder	2 N, LR, LW	267-E
35-038	35-038-BU	8	On Off On	4PDT	5	2	Bat	BCP	0.350	0.250	Solder	2 N, LR, LW	267-E
Retail Part No.	Bulk Part No.	Figure No.	Circuit Function	Poles/Throws	AMPS 125VAC	AMPS 250VAC	Actuator Style	Actuator Material	Bushing Length	Mounting Hole	Terminal Type	Hardware	Spec. Drawing Page No.
35-053	35-053-BU	9	On On	SPDT	5	2	Flat Lever	Metal	0.364	0.250	PCB	2 N, LR, LW	267-F
35-055	35-055-BU	9	On Off On	SPDT	5	2	Flat Lever	Metal	0.364	0.250	PCB	2 N, LR, LW	267-F
35-057	35-057-BU	10	On On	DPDT	5	2	Flat Lever	Metal	0.364	0.250	PCB	2 N, LR, LW	267-F
35-059	35-059-BU	10	On Off On	DPDT	5	2	Flat Lever	Metal	0.364	0.250	PCB	2 N, LR, LW	267-F
35-070	35-070-BU	11	On On	SPDT	6	3	Paddle	Polyamide	0.452	0.500	Solder/QC	N, KN	267-G
35-071	35-071-BU	11	On Off On	SPDT	6	3	Paddle	Polyamide	0.452	0.500	Solder/QC	N, KN	267-G
35-072	35-072-BU	12	On On	DPDT	6	3	Paddle	Polyamide	0.452	0.500	Solder/QC	N, KN	267-G
35-073	35-073-BU	12	On Off On	DPDT	6	3	Paddle	Polyamide	0.452	0.500	Solder/QC	N, KN	267-G

Notes: (On)=Momentary On
BCP=Brass Chrome Plate

KN=Knurled Nut
LR=Lock Ring

LW= Lock Washer
N=Nut(s)

PCB=Printed Circuit Board
QC=Quick Connect

Note: All figures are for illustration purpose only, and the number/type of terminals may vary.

MINIATURE TOGGLES (Cont.)

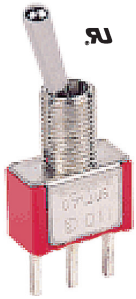

Fig. 1



Fig. 2

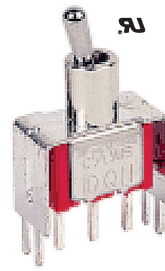

Fig. 3

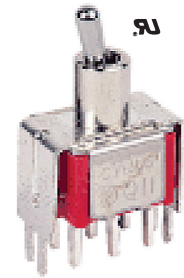

Fig. 4

Miniature Toggles with Printed Circuit Board Terminals

Retail Part No.	Bulk Part No.	Figure No.	Circuit Function	Poles/Throws	125VAC/28VDC	AMPS 250VAC	Actuator Style	Actuator Material	Bushing Length	Mounting Hole	Terminal Type	Hardware	Spec. Drawing Page No.
35-087	35-087-BU	1	On On	SPDT	5	2	Bat	BCP	0.350"	0.250"	PCB	2 N, LR, LW	269-A
35-069	35-069-BU	1	On (On)	SPDT	5	2	Bat	BCP	0.350"	0.250"	PCB	2 N, LR, LW	269-A
35-074	35-074-BU	1	On Off On	SPDT	5	2	Bat	BCP	0.350"	0.250"	PCB	2 N, LR, LW	269-A
35-075	35-075-BU	1	On Off (On)	SPDT	5	2	Bat	BCP	0.350"	0.250"	PCB	2 N, LR, LW	269-A
35-077	35-077-BU	1	(On) Off (On)	SPDT	5	2	Bat	BCP	0.350"	0.250"	PCB	2 N, LR, LW	269-A
35-079	35-079-BU	2	On On	DPDT	5	2	Bat	BCP	0.350"	0.250"	PCB	2 N, LR, LW	269-B
35-081	35-081-BU	2	On (On)	DPDT	5	2	Bat	BCP	0.350"	0.250"	PCB	2 N, LR, LW	269-B
35-082	35-082-BU	2	On Off On	DPDT	5	2	Bat	BCP	0.350"	0.250"	PCB	2 N, LR, LW	269-B
35-083	35-083-BU	2	On Off (On)	DPDT	5	2	Bat	BCP	0.350"	0.250"	PCB	2 N, LR, LW	269-B
35-085		2	(On) Off (On)	DPDT	5	2	Bat	BCP	0.350"	0.250"	PCB	2 N, LR, LW	269-B

Miniature Toggles with Printed Circuit Board with Integral Bracket Terminals

Retail Part No.	Bulk Part No.	Figure No.	Circuit Function	Poles/Throws	125VAC/28VDC	AMPS 250VAC	Actuator Style	Actuator Material	Bushing Length	Mounting Hole	Terminal Type	Spec. Drawing Page No.
35-088	35-088-BU	3	On On	SPDT	5	2	Bat	BCP	0.350"	0.250"	PCB†	269-C
35-089	35-089-BU	3	On (On)	SPDT	5	2	Bat	BCP	0.350"	0.250"	PCB†	269-C
35-091	35-091-BU	3	On Off On	SPDT	5	2	Bat	BCP	0.350"	0.250"	PCB†	269-C
35-093	35-093-BU	3	On Off (On)	SPDT	5	2	Bat	BCP	0.350"	0.250"	PCB†	269-C
35-095	35-095-BU	3	(On) Off (On)	SPDT	5	2	Bat	BCP	0.350"	0.250"	PCB†	269-C
35-096	35-096-BU	4	On On	DPDT	5	2	Bat	BCP	0.350"	0.250"	PCB†	269-D
35-097	35-097-BU	4	On (On)	DPDT	5	2	Bat	BCP	0.350"	0.250"	PCB†	269-D
35-098	35-098-BU	4	On Off On	DPDT	5	2	Bat	BCP	0.350"	0.250"	PCB†	269-D
35-099	35-099-BU	4	On Off (On)	DPDT	5	2	Bat	BCP	0.350"	0.250"	PCB†	269-D
35-101	35-101-BU	4	(On) Off (On)	DPDT	5	2	Bat	BCP	0.350"	0.250"	PCB†	269-D

Notes: (On)=Momentary On
BCP=Brass Chrome Plate

LW= Lock Washer
N=Nut(s)

LR=Lock Ring
PCB=Printed Circuit Board
PCB†=Printed Circuit Board with Integral Bracket

Note: All figures are for illustration purpose only, and the number/type of terminals may vary.

MINIATURE TOGGLES (Cont.)

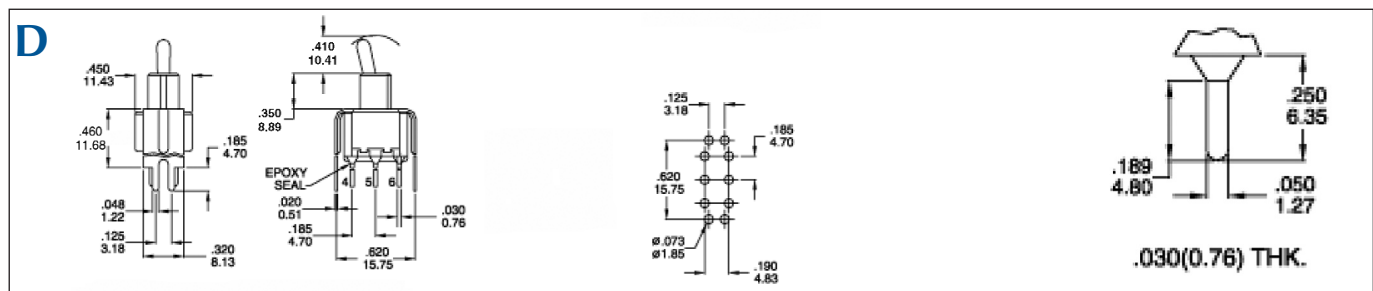
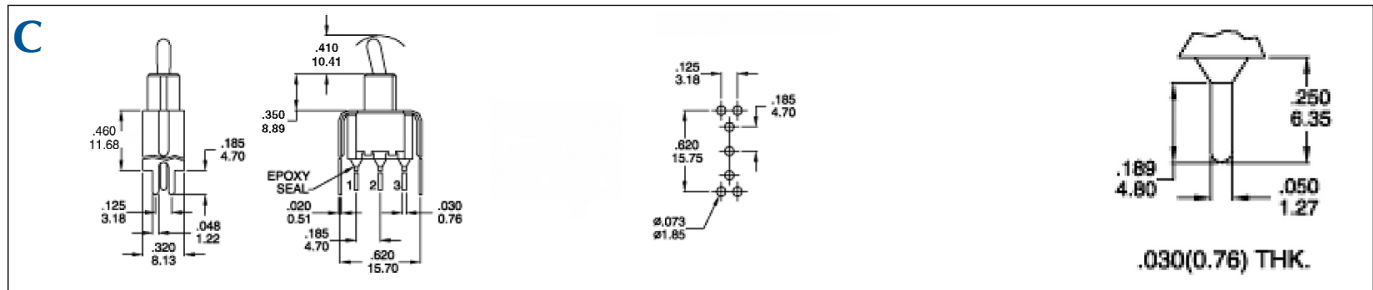
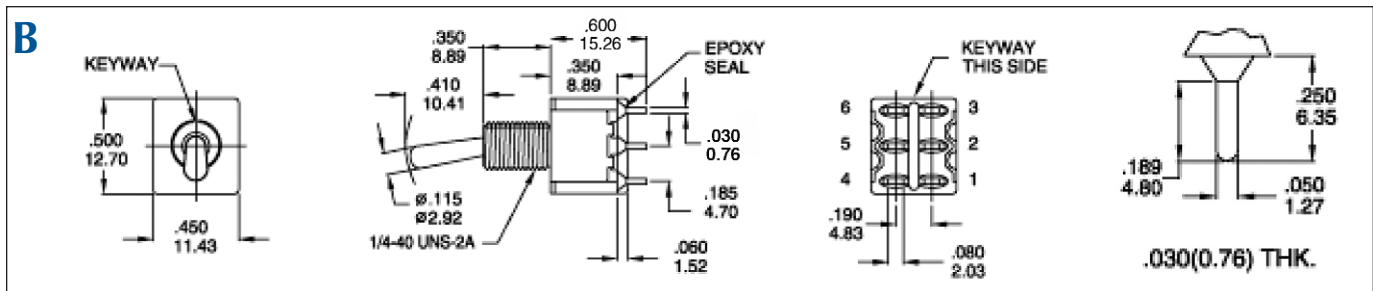
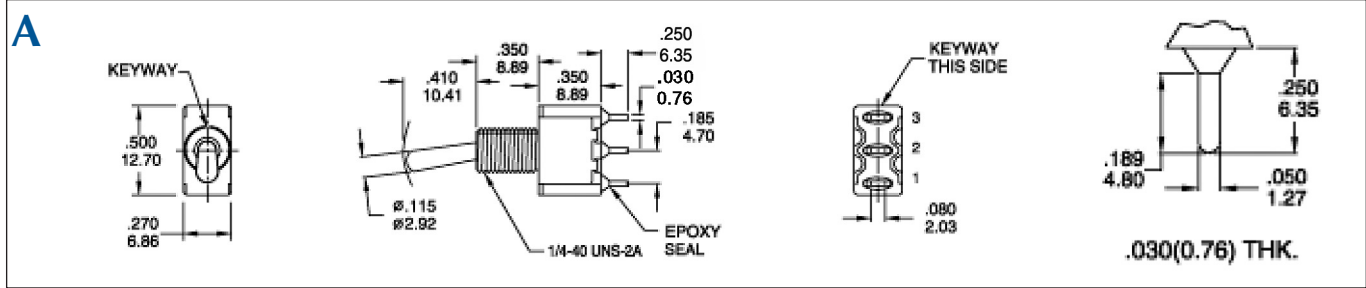

Switches

MINIATURE TOGGLES (Cont.)



Fig. 1



Fig. 2

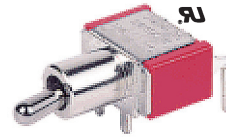

Fig. 3

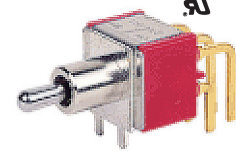

Fig. 4

Miniature Toggles with Printed Circuit Board Right Angle Vertical Mount Terminals

Retail Part No.	Bulk Part No.	Figure No.	Circuit Function	Poles/Throws	125VAC/28VDC	AMPS 250VAC	Actuator Style	Actuator Material	Bushing Length	Mounting Hole	Terminal Type	Spec. Drawing Page No.
35-102	35-102-BU	1	On On	SPDT	5	2	Bat	BCP	0.350"	0.250"	PCB++	271-A
35-103	35-103-BU	1	On (On)	SPDT	5	2	Bat	BCP	0.350"	0.250"	PCB++	271-A
35-104	35-104-BU	1	On Off On	SPDT	5	2	Bat	BCP	0.350"	0.250"	PCB++	271-A
35-105	35-105-BU	1	On Off (On)	SPDT	5	2	Bat	BCP	0.350"	0.250"	PCB++	271-A
35-106	35-106-BU	1	(On) Off (On)	SPDT	5	2	Bat	BCP	0.350"	0.250"	PCB++	271-A
35-107	35-107-BU	2	On On	DPDT	5	2	Bat	BCP	0.350"	0.250"	PCB++	271-B
35-108	35-108-BU	2	On (On)	DPDT	5	2	Bat	BCP	0.350"	0.250"	PCB++	271-B
35-109	35-109-BU	2	On Off On	DPDT	5	2	Bat	BCP	0.350"	0.250"	PCB++	271-B
35-111	35-111-BU	2	On Off (On)	DPDT	5	2	Bat	BCP	0.350"	0.250"	PCB++	271-B
35-113	35-113-BU	2	(On) Off (On)	DPDT	5	2	Bat	BCP	0.350"	0.250"	PCB++	271-B

Miniature Toggles with Printed Circuit Board Right Angle Horizontal Mount Terminals

Retail Part No.	Bulk Part No.	Figure No.	Circuit Function	Poles/Throws	125VAC/28VDC	AMPS 250VAC	Actuator Style	Actuator Material	Bushing Length	Mounting Hole	Terminal Type	Spec. Drawing Page No.
35-115	35-115-BU	3	On On	SPDT	5	2	Bat	BCP	0.350"	0.250"	PCB+++	271-C
35-121	35-121-BU	3	On (On)	SPDT	5	2	Bat	BCP	0.350"	0.250"	PCB+++	271-C
35-122	35-122-BU	3	On Off On	SPDT	5	2	Bat	BCP	0.350"	0.250"	PCB+++	271-C
35-123	35-123-BU	3	On Off (On)	SPDT	5	2	Bat	BCP	0.350"	0.250"	PCB+++	271-C
35-125	35-125-BU	3	(On) Off (On)	SPDT	5	2	Bat	BCP	0.350"	0.250"	PCB+++	271-C
35-127	35-127-BU	4	On On	DPDT	5	2	Bat	BCP	0.350"	0.250"	PCB+++	271-D
35-129	35-129-BU	4	On (On)	DPDT	5	2	Bat	BCP	0.350"	0.250"	PCB+++	271-D
35-131	35-131-BU	4	On Off On	DPDT	5	2	Bat	BCP	0.350"	0.250"	PCB+++	271-D
35-133	35-133-BU	4	On Off (On)	DPDT	5	2	Bat	BCP	0.350"	0.250"	PCB+++	271-D
35-135	35-135-BU	4	(On) Off (On)	DPDT	5	2	Bat	BCP	0.350"	0.250"	PCB+++	271-D

Notes: (On)=Momentary On
BCP=Brass Chrome Plate

KN=Knurled Nut
LR=Lock Ring

LW= Lock Washer
N=Nut(s)

PCB=Printed Circuit Board
PCB+=Printed Circuit Board with Integral Bracket
QC=Quick Connect
PCB++=Printed Circuit Board Right Angle Vertical Mount
PCB+++=Printed Circuit Board Right Angle Horizontal Mount



Fig. 5



Fig. 6



Fig. 7



Fig. 8

Retail Part No.	Bulk Part No.	Figure No.	Circuit Function	Poles/Throws	AMPS 125VAC	AMPS 250VAC	AMPS 12VDC	HP 125-250VAC	Actuator Style	Color	Bushing Length	Mounting Hole	Terminal Type	Hardware	Spec. Drawing Page No.
35-090	35-090-BU	5	On Off	SPST			16		Paddle*	Red	0.342	0.500	QC .250"	N, LN	271-E
35-092	35-092-BU	5	On Off	SPST			16		Paddle*	Green	0.342	0.500	QC .250"	N, LN	271-E
35-094	35-094-BU	5	On Off	SPST			16		Paddle*	Amber	0.342	0.500	QC .250"	N, LN	271-E
35-3008	35-3008-BU	6	On Off	SPST	15	10		3/4	Paddle	Black		0.550 x 1.125	QC .250"	N, LN	271-F
35-3091	35-3091-BU	7	On Off	SPST	15	10		3/4	Paddle**	Amber		0.550 x 1.125	QC .250"	N, LN	271-F
35-3092	35-3092-BU	7	On Off	SPST	15	10		3/4	Paddle**	Red		0.550 x 1.125	QC .250"	N, LN	271-F
35-3140	35-3140-BU	8	On Off	SPST	15	10		3/4	Paddle*	Red/Green	0.379	0.500	QC .250"	N, FN	271-G

Notes: *Lighted Paddles (12V Incandescent)

**Lighted Base (125 V Neon)

FN=Face Nut

HP=Horse Power

LN=Locking Nut

N=Nut

QC=Quick Connect

Note: All figures are for illustration purpose only, and the number/type of terminals may vary.

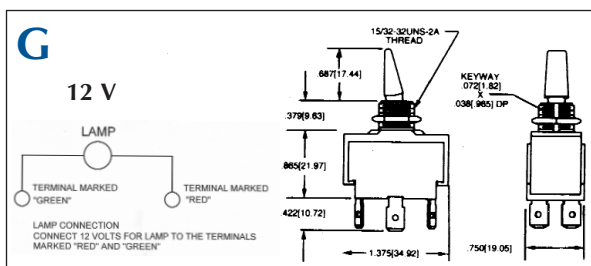
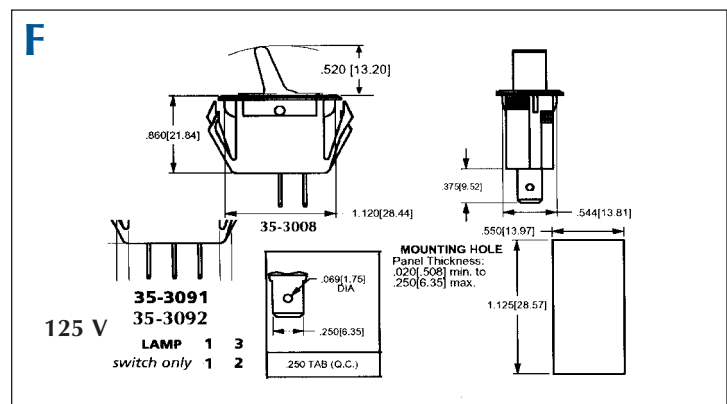
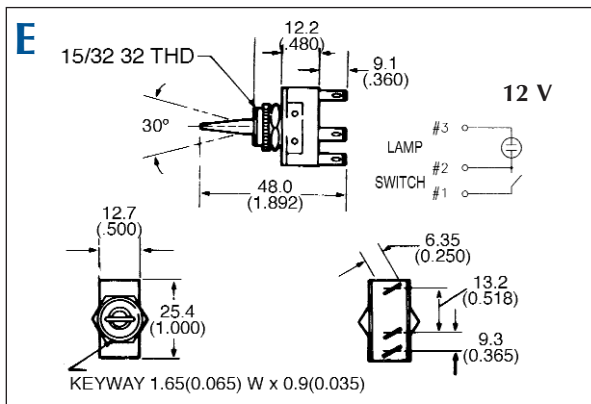
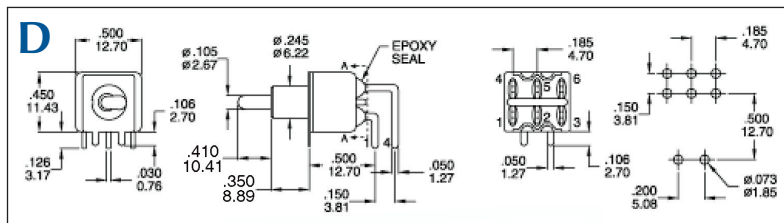
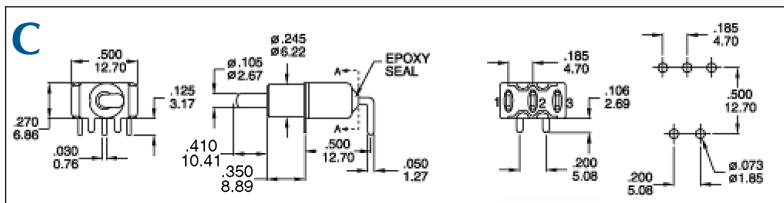
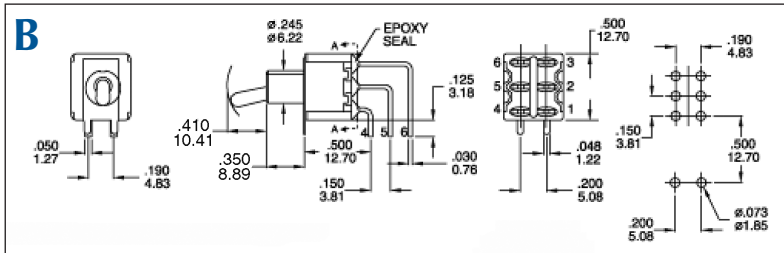
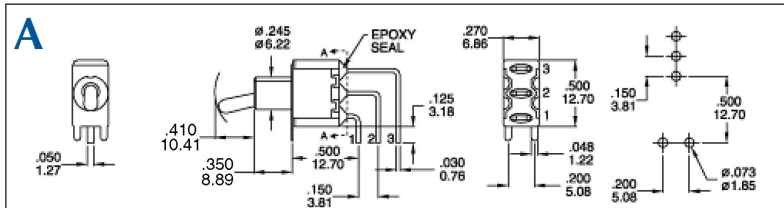

Switches