

An economical solid-state TDR with octal plug-in base, the 339 maintains excellent repeat accuracy despite wide voltage and temperature variations/ even after long periods of down-time. Two models are available. Each has six dial selected ranges from fractions of a second to as long as 10 hours. Each model has a selectable on-delay or interval timing mode.

WIDE CHOICE OF RANGES: In addition to the short ranges expected of an electronic TDR, the 339 is also available with ranges as long as 10 hours. An unusually versatile timer, the 339 has six dial-selected ranges—from 0.3 seconds to 3 hours or 1 second to 10 hours—and provides dial-adjustable timing periods between 0.075 seconds and 10 hours. A single 339 model thus accommodates the needs of a wide range of applications, allowing the user to select easily and precisely—an appropriate range to permit optimum setting accuracy. The dial face automatically displays the selected range.

CYCLE PROGRESS INDICATION: The 339's LED annunciator provides a unique and effective method of cycle progress indication. Off before timing, the LED blinks at an ever-increasing rate as the cycle progresses; once every 3-1/2 seconds during the first 10% of the cycle, twice during the second 10%, and so on. At time-out, the LED stays on constantly, pulsing at a high rate. (In the 1 and 10-second ranges, the LED is off before timing, steady on during timing, and pulsing on after time-out.)

HIGH ACCURACY: The 339's timing circuit is not a simple RC circuit, but includes counting technology along with a stable oscillator to provide repeatable time delays.

MULTIPLE TIMING MODES: Every 339 can be used for either on-delay or interval timing operation. The timing mode is selectable by a switch on the 339 housing.

OPERATION

Timing begins when the start switch is closed. This starts an oscillator which runs at a frequency determined by the time setting. A fixed number of counts from the oscillator determines the end of the time cycle. The time required to accomplish this depends on the oscillator frequency. During timing, a LED located on the dial face blinks. For the first ten percent of the cycle, the LED repeatedly blinks once followed by a pause, for the second 10%, it blinks twice and so on indicating the cycle progress. It flashes rapidly and continuously after time out.

ON-DELAY MODE: At time out, the built-in relay transfers its contacts. These contacts remain transferred until the start switch is opened or power is removed by some other means. The 339 then resets and is ready for another cycle.

INTERVAL MODE: When timing begins, the built-in relay transfers its contacts. The contacts remain transferred until time out. The timer will not start again until the start switch is opened or power is removed by some other means. The 339 then resets and is ready for another cycle.

WIRING

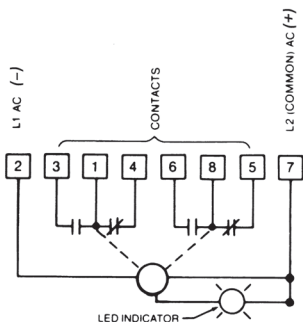

TYPICAL CIRCUIT

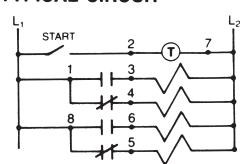

*For interval operation with a momentary start switch, jumper 2 and 3.

ONDELAY INTERVAL

- OOX
- XXO
- OOX
- XXO

- OXO
- XOX
- OXO
- XOX

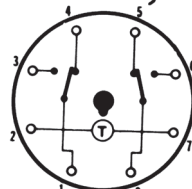

TERMINAL WIRING



Plug-In Adjustable Time Delay Relay

MODEL NUMBER

MODEL NUMBER	339B				
---------------------	------	--	--	--	--

RANGE				
Six dial-selected ranges (.3 or 3 SEC, MIN, HR)	359			
Six dial-selected ranges (1 or 10 SEC, MIN, HR)	200			

VOLTAGE & FREQUENCY			
120 VAC, 50/60 Hz	Q		
240 VAC, 50/60 Hz	R		
24 VAC, 50/60 Hz, 24 VDC	T		
12 VDC	E		

ARRANGEMENT			
ON-Delay, Interval Mode	2		
Special	0		

FEATURES			
Standard		X	
Special		K	

ACCESSORIES			
8-Pin surface/DIN rail socket	000-825-85-00		
Hold down for above socket (2 required)	339-025-03-00		
Plug-in socket kit (8-pin)	319-261-45-00		

SPECIFICATIONS

MODELS	Choice of two multi-range units. All models operate in on-delay or interval mode.								
RANGES	Choice of two models Six dial-selected ranges: 1.0 and 10 SEC, MIN, HR or 0.3 and 3 SEC, MIN, HR								
MINIMUM SETTING	3% of range, except 75 mSEC on 0.3 SEC and 1.0 SEC ranges.								
LOAD RELAY	<table border="0"> <tr> <td>TYPE</td> <td>DPDT 10 AMPS resistive at 30 VDC or 250 VAC (or less) 1/8 HP @120 VAC</td> </tr> <tr> <td>LIFE</td> <td>10 million operations with no load 100,000 operations with: 10 AMPS at 30 VDC (or less) or 10 AMPS at 250 VAC (or less)</td> </tr> <tr> <td>CONTACT MATERIAL</td> <td>Silver Cadmium Oxide</td> </tr> </table>	TYPE	DPDT 10 AMPS resistive at 30 VDC or 250 VAC (or less) 1/8 HP @120 VAC	LIFE	10 million operations with no load 100,000 operations with: 10 AMPS at 30 VDC (or less) or 10 AMPS at 250 VAC (or less)	CONTACT MATERIAL	Silver Cadmium Oxide		
TYPE	DPDT 10 AMPS resistive at 30 VDC or 250 VAC (or less) 1/8 HP @120 VAC								
LIFE	10 million operations with no load 100,000 operations with: 10 AMPS at 30 VDC (or less) or 10 AMPS at 250 VAC (or less)								
CONTACT MATERIAL	Silver Cadmium Oxide								
TEMPERATURE RATING	0° to 140°F (-17° to 60°C)								
MOUNTING	<p>Plug-in octal base; mounts in any position with retaining clips.</p> <p>OPTIONS: Surface mounting socket DIN rail mounting socket Panel-mounting adapter kit Plug-on socket Rear facing terminal socket.</p>								
POWER REQUIREMENTS	<table border="0"> <tr> <td>120 VAC</td> <td>95 - 132 VAC, 50/60Hz Inrush - .4A Running - .025</td> </tr> <tr> <td>240 VAC</td> <td>190 - 264 VAC, 50/60 Hz Inrush - .2A Running - .013A</td> </tr> <tr> <td>24 VAC/DC</td> <td>19.2 - 26.4 VAC/DC Inrush - .4A Running - .075A</td> </tr> <tr> <td>12 VDC</td> <td>9.6 - 13.2 VDC Inrush - .25A Running - .10A</td> </tr> </table>	120 VAC	95 - 132 VAC, 50/60Hz Inrush - .4A Running - .025	240 VAC	190 - 264 VAC, 50/60 Hz Inrush - .2A Running - .013A	24 VAC/DC	19.2 - 26.4 VAC/DC Inrush - .4A Running - .075A	12 VDC	9.6 - 13.2 VDC Inrush - .25A Running - .10A
120 VAC	95 - 132 VAC, 50/60Hz Inrush - .4A Running - .025								
240 VAC	190 - 264 VAC, 50/60 Hz Inrush - .2A Running - .013A								
24 VAC/DC	19.2 - 26.4 VAC/DC Inrush - .4A Running - .075A								
12 VDC	9.6 - 13.2 VDC Inrush - .25A Running - .10A								
REPEAT ACCURACY	<p>Varies as a function of line voltage and temperature but not of reset time</p> <p>a $\pm 0.5\%$ at constant temperature and voltage. (or ± 15 mSEC whichever is greater)</p> <p>b $\pm 1\%*$ at constant voltage and full temperature range. (or ± 25 mSEC which ever is greater)</p> <p>c $\pm 1.5\%*$ at constant temperature and full voltage range. (or ± 25 mSEC whichever is greater)</p> <p>d $\pm 2\%*$ over full voltage and temperature range. (or ± 30 mSEC, which ever is greater)</p> <p>*Variations of line voltage must be within 95 and 132V; of temperature between -17° and 60°C (0° and 140°F)</p>								
RECYCLE CHARACTERISTICS	<p>The timer can be used as a pulse generator with L1 power wired though its NC contacts. The pulse will be 35 mSEC to 90 mSEC long. (40 mSEC typical pulse.)</p> <p>a 0 to 20 mSEC power interruption; Guaranteed no reset.</p> <p>b 20 mSEC to 90 mSEC; it may reset. (40 mSEC typical reset).</p> <p>c Over 90 mSEC guaranteed to reset. The TDR will reset properly and not start timing when subjected to an open start switch leakage of 1.5 mA or less. (Prox switch and Triac drive applications)</p>								
WEIGHT	2.5 oz. (70 g)								

DIMENSIONS (INCHES/MILLIMETERS)

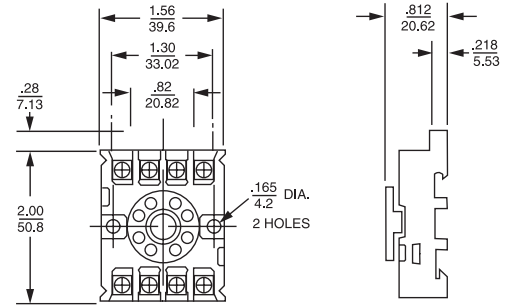
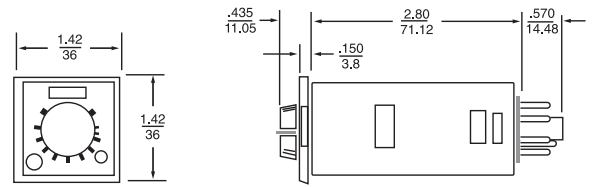

8 PIN OPTIONAL OCTAL SOCKET NO. 00008258500

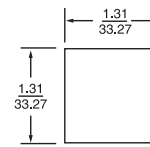

CUTOUT

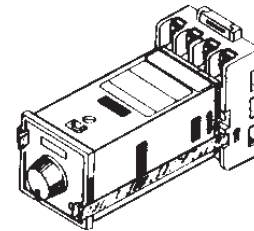

00008258500 SOCKET WITH 339-025-03-00 HOLD DOWNS

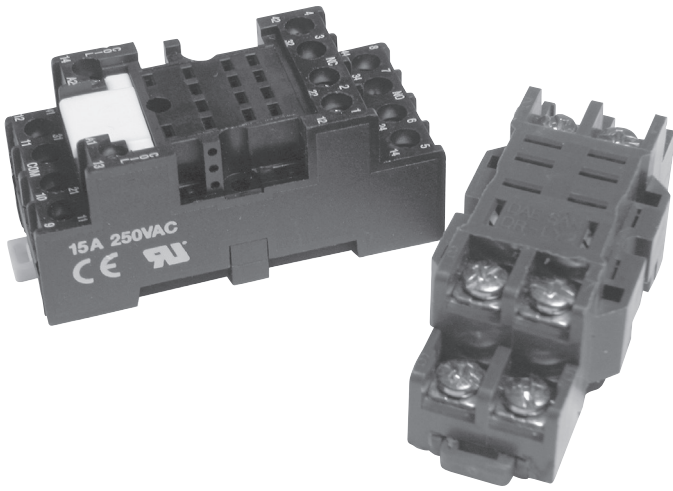

8 and 11-Pin Base Mount/Din Rail Sockets

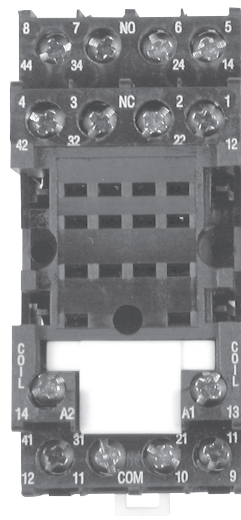

600-3-0018
DIN Rail or Base Mount, 4PDT,
Miniature Relay Socket
30mm (W) x 71.5mm (T) x 29mm (D)

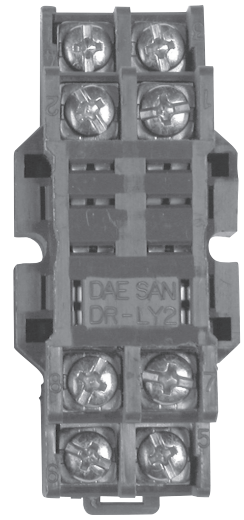

600-3-0019
DIN Rail or Base Mount, DPDT for
.187 Terminal Relays (10 Amp.) Socket
32mm (W) x 67mm (T) x 27mm (D)

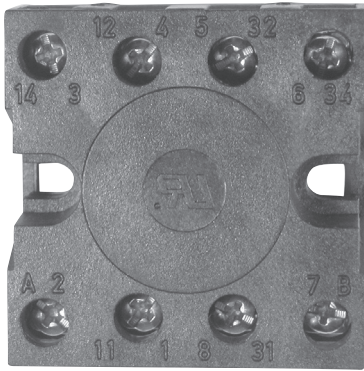

600-3-0011
Panel Mount, 8 Pin
43.5mm (W) x 43.5mm (T) x 20mm (D)

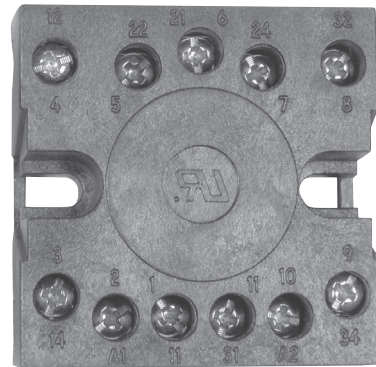

600-3-0012
Panel Mount, 11 Pin
47mm (W) x 47mm (T) x 20mm (D)

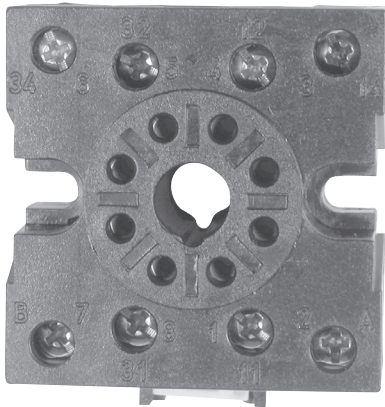

600-3-0013
DIN Rail or Base Mount, 8 Pin
43.5mm (W) x 43.5mm (T) x 20mm (D)

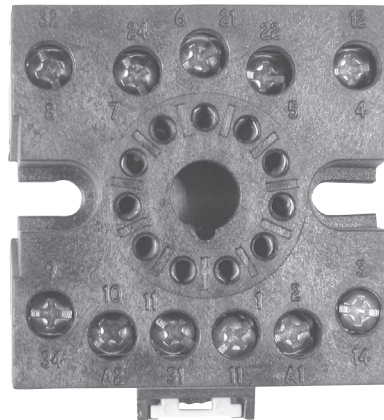

600-3-0014
DIN Rail or Base Mount, 11 Pin
47mm (W) x 47mm (T) x 20mm (D)

1/16 DIN TIMER ACCESSORIES—8 PIN ACCESSORIES

000-825-85-00

8-Pin surface DIN rail socket.

Recommended for use with all 8-pin octal plug-in devices when surface mounting or DIN rail mounting.

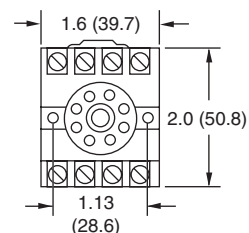
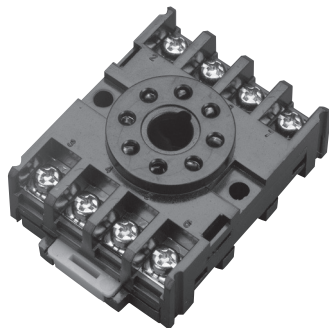

API 008FS

8-Pin Finger-Safe Socket.

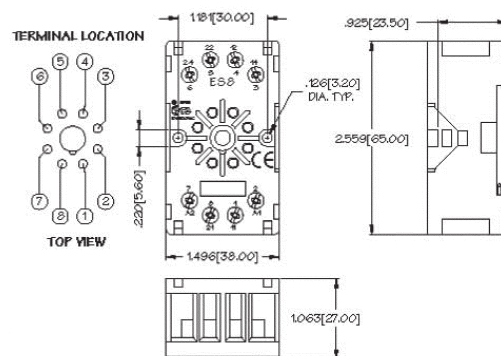
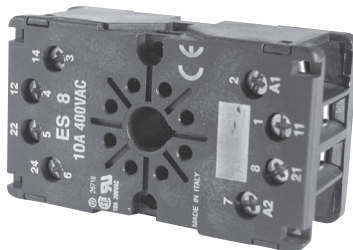

319-261-45-00

Plug-on socket kit (8 pin). Recommended for use with all 8-pin octal plug-in devices. Panel mounting only. Attach the wires to the solderless connector with a crimping tool.

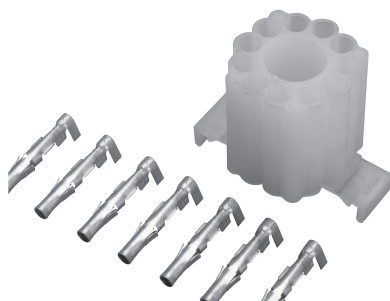

405-320-02-00

Panel Mounting bracket. Recommended for use with all 1/16 DIN timers when panel mounting. Use in conjunction with the 8-pin or 11-pin panel socket with rear facing terminals.

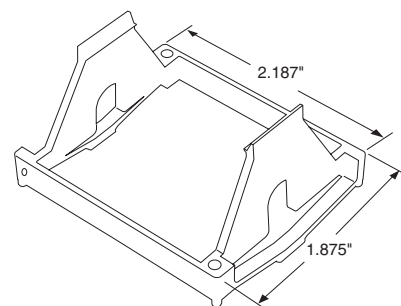
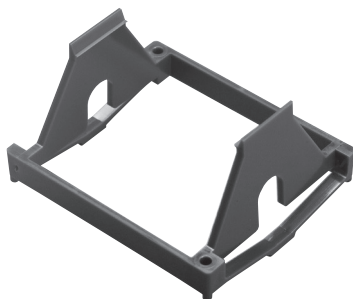

407-025-13-00

Hold-down for part #000-825-85-00.

Two (2) needed for proper installation.

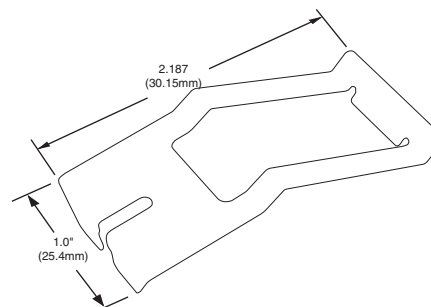
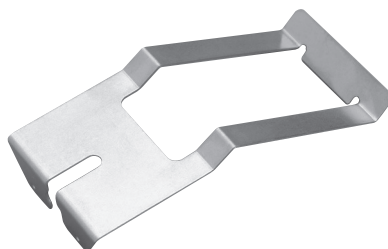

1/16 DIN TIMER ACCESSORIES—8 PIN ACCESSORIES

000-825-86-00

11-Pin surface DIN rail socket.
Recommended for use with all 11-pin octal plug-in devices when surface mounting or DIN rail mounting.

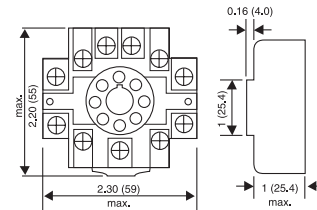
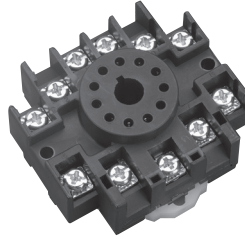

70-463-1

11-Pin Socket, DIN/Panel Mount, with screw terminals & Clamping plates.

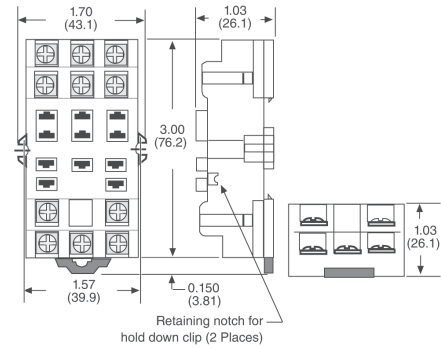
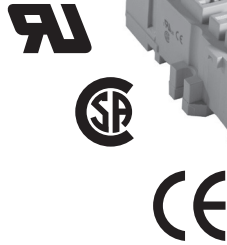
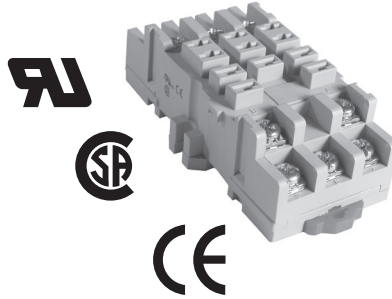

314-260-07-00

Plug-on socket kit (11-pin).
Recommended for use with all 11-pin octal plug-in devices. Panel mounting only. Attach the wires to the solderless connector with a crimping tool.

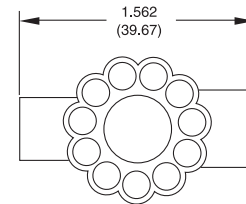
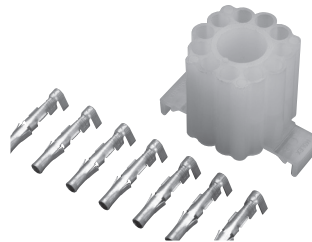

405-025-07-00

Hold down for part #000-825-86-00.
Two (2) needed for proper installation.

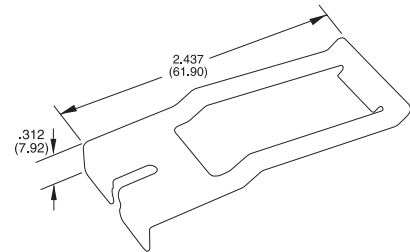
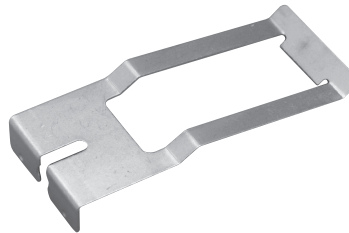

101-026-105

Recommended for use with all the ATC Diversified Electronics family of "remote adjustable" timers. Proper spacing is maintained for UL and CSA applications. This linear taper potentiometer has a non-conductive shaft attached to the internal conductive plastic wafer. The brass bushing is 3/8" x 32NEF and accepts adjustment hardware 1000540070, 100054071.

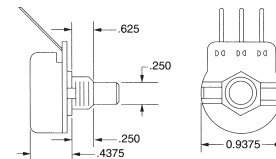
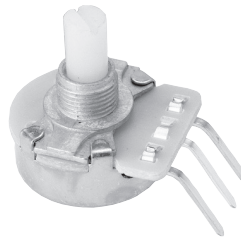

100-054-073

Recommended for use with any adjustment or switch having a 1/4" shaft. This knob slips over the shaft and is secured in place by a #6-32 set screw. The knurled, mirror finished, black thermostat knob has a white pointer line for reference.

