



CATALOGUE
2019



Wiha – our goal: your success

- **Your guarantee for quality**
Winner of the Manufacturing Excellence Awards 2014 as the best SME in Germany.
- **Reliable and dependable**
German family-owned company with more than 75 years of experience.
- **Your advantage**
Customised problem-solving for professionals.
- **Cutting-edge technology**
Award-winning innovations valued by professionals throughout the world.





What makes your work easier?

Tools that increase your efficiency, reduce costs and preserve your health. This is why Wiha develops, designs and manufactures products that meet the highest functionality, durability and ergonomic demands.

Founded over 75 years ago as a small family-owned business for standard parts and screws, Wiha has grown to become a global company with factories all over Europe, Asia and the United States and are still owner-operated by the Hahn family.

Wiha offers the professional a wide range of high-quality premium tools, characterized by their use of the latest manufacturing technologies, application-oriented innovations, ergonomic superiority, top quality, absolute reliability and long service life. In short, tools that make your work noticeably easier - tools that work for you.

Learn more about Wiha on our website:
www.wiha.com

Wiha visions and values

With responsibility and innovation, Wiha is set for a successful future.

What makes a company successful? Providing excellent products and having a good company culture are key. The high quality of Wiha tools in their form and functionality is confirmed by the many international awards they have received. As an owner-operated family-owned company, we foster a culture of togetherness. From employee development to active customer management, Wiha does everything they can to create optimum working and business conditions and a foundation for sustainable success.

As a member of the BME Compliance Initiative, Wiha complies with a code of conduct which obligates the company to follow business conduct rules, principles of social responsibility and the obligation to promote suppliers, ensuring the lawful behaviour of the company and its employees.

In 2016, Wiha was crowned one of the TOP 100 most innovative mid-sized companies in Germany. Thanks to their practised culture of innovation, Wiha was able to succeed at the competition held as part of the "German Mid-Sized Company Summit." We took this as encouraging confirmation of our company philosophy, which focusses on progress and vision.

Wiha – our visions

- **A financially successful family-owned company**

For more than 75 years, Wiha has been a successful owner-operated company in the market.

- **Premium international brand**

Wiha supplies an international market from factories in Europe, Asia and the USA.

- **Highly motivated first-class team:**

Wiha employees are competent, committed and motivated thanks to their optimum working conditions.

- **User- and application-focused:**

Wiha products enable the user to work in an efficient and health-friendly way.

Wiha design awards

Ergonomics, highly prized by all.



2013 / iTorque



product
design award

2013



reddot design award
winner 2013



2013 / MaxxTor



product
design award

2013



2013 / BitBuddy®



product
design award

2013



reddot design award
winner 2013



Focus Open 2013
Silver



2014 / Magazine Bit Holder LiftUp



product
design award

2014



reddot award 2014
best of the best





To us, positive feedback from people for whom we make our tools is the most rewarding confirmation of our work. All the same, we can also be more than a little proud when the high ergonomic quality of our products is confirmed at the "highest" level, as many of them have been distinguished with coveted design awards. In addition to this, our company and production quality were also honoured with awards. With this praise and confirmation from every direction, it's no wonder that Wiha are on the right track with ergonomic tool concepts and a future-oriented philosophy.



2014 / BiCut®



reddot award 2014 winner



2015 / Bit Holder CentroFix MagicFlip



2015 / FlipSelector



reddot award 2015 winner



2017 / 2018 / 26one®



reddot design award winner 2017



Focus Open 2017 Silver



GERMAN DESIGN AWARD WINNER 2018



2018 / speedE®



Focus Open 2018 Special Mention



GERMAN DESIGN AWARD GOLD 2019

Wiha tools with AGR approval

The world's first tools awarded the seal of approval for efficient and health-preserving work.



Ergonomic excellence!

Wiha is the world's first hand tool manufacturer to receive the AGR seal for its Inomic® pliers and ergonomic handle design on screwdrivers. This distinction enjoys broad acceptance by medical professionals

Ergonomic excellence - The Wiha screwdriver handle size concept and Wiha Inomic® pliers handle concept. When you are the first hand tool manufacturer in the world to have products distinguished with the renowned AGR quality seal, it's a sensation. Very few everyday objects are able to pass the stringent tests of the AGR, whose seal enjoys broad acceptance by medical professionals for very good reason.

For years, the AGR have been dedicated to promoting and researching the prevention of back pain and they offer recommendations on products which help to prevent musculoskeletal disorders and back pain.



Wiha have now been officially recognised for their ergonomic screwdriver handle size concept and Inomic® pliers handle concept. To us, this distinction is confirmation of our philosophy: To develop tools enabling the professional to not only work efficiently, but also in a health-preserving way. Wiha's screwdriver handle size concept features four handle sizes and lengths, each optimally suited to its respective fastening or work task to ensure healthy work. The angled "pistol handle" of the Wiha Inomic® pliers handle concept relieves the user's wrist while working.

Both handle concepts help users to reduce, or even fully prevent, discomfort in their musculoskeletal system and pain in their joints and muscles. The result? With Wiha, your work is easier, you don't get fatigued as quickly, you work more efficiently and you simply feel better at the end of the working day. As our campaign logo motto goes: "I feel Wiha!"

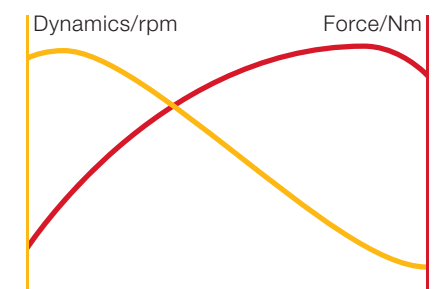

Wiha SoftFinish® handle sizes

Every Wiha handle optimally balances guidance, speed and torque for the respective fastening task.

Quick-turning - Motor skills are consistently taken into consideration.

Maximum power transmission, comfortable to use and without loss.



VDE-insulated tools from Wiha

To work safer, more efficiently and with less strain on the body.



Certified safety – from our own safety testing procedure according to IEC standards.

Voltage testing: All Wiha VDE-tools, which have special markings, are individually tested at 10,000 V AC and are approved for 1,000 V AC and 1,500 V DC.

Cold shock test: Cooling down to -25° C. The skinning material must retain its toughness, so that it doesn't break when subjected to shock and knocks.

Test of electrical skinning properties: 24 hours storage in water, then 3 minutes test at 10,000 V AC. There must neither be flashover nor disruptive discharge.

Test of the adhesion of the skinning material coating: 168 hours storage at 70° C, then test of adhesion at 500 N.

Pressure tests: Test at 20 N pressure load, 70° C temperature and 5,000 V AC test voltage. No disruptive discharge may occur.

Test of combustion behaviour: The tools are subjected to a flame for 10 seconds. The skinning material must then extinguish and not continue to burn.

Safety note

The following equipment is required for all work on or around live components and should be appropriate for the specific task

- insulating personal protective equipment
- insulating safety mechanisms
- insulated tools

Before starting work, you must disconnect all active, live components of electrical machines and equipment and ensure that they remain disconnected while you carry out the work.

This is achieved by complying with the five safety rules:

- disconnect
- secure against reconnection
- ensure power is switched off
- earth and short-circuit
- cover or block off adjacent live components



As an internationally recognized institute, the VDE is responsible for the testing and certification of electrotechnical products. Wiha provides the professional with a broad range of VDE products, developed and continuously optimized specifically for electricians, which also provide application-oriented solutions for everyday use.

The Wiha quality-management system according to ISO 9001:2015 ensures that only first-class products are manufactured – and that you can work with products of excellent quality. To ensure maximum safety for the user, the entire Wiha VDE range must undergo the most stringent inspections and individual tests. All Wiha VDE-tools hold multiple certifications: The VDE-GSmark stands for safety with regard to any risk, from electrical right up to radiological. Products labelled with a double triangle and a voltage range are suitable for work with live parts.

The international standard IEC 60900 defines the construction, safety as well as single, series, and random testing of insulated tools. But with Wiha you don't just work safer, but also healthier and more efficiently. Specially developed ergonomic geometries ensure comfortable handling that protects the body from strain. The result: easier work, less signs of fatigue, more efficiency.



Content

Competence XXL II electrician's tool set
Page 108



Tool set service technician
Page 112



Tool set electrician
Page 113



Tool set electrician
Page 116



E-screwdriver, set 2, speedE®
Page 126



Flashlight with LED, laser and UV light
Page 128



Torque QuickCheck torque testing device
Page 129



Screwdriver and bit set slimVario® screwdriver
Page 132



Screwdriver SoftFinish® electric slimFix
Page 138



Screwdriver SoftFinish®
Page 146



Fine screwdriver PicoFinish
Page 152



Torque screwdriver set TorqueVario®-S electric
Page 162



Torque screwdriver TorqueVario®-S electric
Page 163



Torque screwdriver with T-handle TorqueVario®-S T electric
Page 165



Torque screwdriver iTorque®
Page 168



Screwdriver with bit magazine LiftUp electric
Page 180



Screwdriver with bit magazine LiftUp 26one®
Page 181



Multitool PocketStar
Page 183



Nut driver insert gripper
Page 186



L-key set in ErgoStar holder
Page 196



L-key set in ProStar holder
Page 198



L-key set in ProStar holder
Page 198



L-key set in ErgoStar holder
Page 202



BitBuddy® TY bit set, 29 mm
Page 223



XLSelector T bit set, 50 mm
Page 224



TY bit set 29 mm
Page 224



T bit set, 25 mm
Page 225



Installation pliers TriCut Professional electric
Page 253



Combination pliers Professional electric with DynamicJoint® and OptiGrip
Page 256



Stripping tool automatic
Page 262



Automatic crimp tool
Page 265



Soft-faced hammer Safety soft/medium hard
Page 295



Soft-faced hammer dead-blow, medium hard
Page 196



Electrician's hammer
Page 301



SoftFinish® dowel racket set with dowels
Page 301



Ratchet wrench set insulated 3/8"
Page 117



Tool set mechanic
Page 121



Tool set ESD
Page 123



Ranges
From page 106

Screwdriver MicroFinish®
Page 155



Screwdriver SoftFinish® ESD
Page 158



Electro
From page 124

Torque screwdriver TorqueVario®-S
Page 168



Torque screwdriver with T-handle TorqueVario®-S T
Page 172



Torque screwdriver TorqueVario®-S ESD
Page 175



Screwdrivers
From page 130

Screwdriver with interchangeable blade set SYSTEM 6
Page 187



Screwdriver with interchangeable blade set SYSTEM 4
Page 191



Screwdriver with interchangeable blade set SYSTEM 4 ESD
Page 193



Multitools
From page 178

L-key set in ProStar holder
Page 203



L-key with T-handle ComfortGrip
Page 204



L-key with key handle
Page 206



L-keys
From page 194

Y bit set, 25 mm
Page 236



Bit Professional 1/4"
Page 236



Bit holder CentroFix Force mechanically lockable
Page 246



Bits
From page 220

Professional BiCut® high-performance diagonal cutters with DynamicJoint®
Page 268



Pliers wrench Classic
Page 275



Circlip pliers Classic with MagicTips®
Page 278



Pliers
From page 250

Electrician's spirit level
Page 302



Electrician's Longlife® folding ruler, 2 m
Page 303



Striking and measuring tools
From page 292

Information
From page 304



**Competence XXL II electrician's
tool set**

assorted 115-pcs. in case

Order-No. 42069

More information: Page 108

Further information:



Meets your requirements: Case: robust, large, stable and secure with lid brake. **Lowers your costs:** The correct torque protects material from damage and ensures no additional follow-up work. **Increases your safety:** Internationally award-winning VDE-insulated tools, each individually tested at 10,000 V AC and approved for use at 1,000 V AC. Gas-filled shock absorbers hold the lid in all positions and reduce the risk of injury when closing. **Protects your health:** Wiha pliers require less force and reduce pressure on wrists. Ergonomic handle design makes work easier and prevents occupational illnesses. Trolley with stable in-line rollers allow easy and stress-free transportation of tools to the work area. **Increases your efficiency:** A comprehensive tool assortment, always providing you with the right tool when it is needed. The design and function of the tool trays guarantee quick and easy access to tools. **Increases your flexibility:** Ample space for additional tools and lots of storage for small parts and machines.





VDE-certified tools

Insulated tools are essential for all work on or around live components.

- Wiha VDE-tested tools are subject to stringent safety test procedures.
- All tools with the special marking have been tested at 10,000 V AC and are therefore approved for use at 1,000 V AC and 1,500 V DC.
- Certified by the VDE Testing and Certification Institute and individually tested according to the international standard IEC 60900.

The following equipment is required for all work on or around live components and should be appropriate for the specific task

- insulating personal protective equipment
- insulating safety mechanisms
- insulated tools

Before starting work, you must disconnect all active, live components of electrical machines and equipment and ensure that they remain disconnected while you carry out the work.

This is achieved by complying with the five safety rules:

- disconnect
- secure against reconnection
- ensure power is switched off
- earth and short-circuit
- cover or block off adjacent live components



Meets your requirements: Case: robust, large, stable and secure with lid brake.
Lowers your costs: The right tool protects you from damaging materials and avoids subsequent work. **Increases your safety:** Internationally award-winning VDE-insulated tools, each individually tested at 10,000 V AC and approved for use at 1,000 V AC. Gas-filled shock absorbers hold the lid in all positions and reduce the risk of injury when closing. **Protects your health:** Wiha pliers require less force and reduce pressure on wrists. Ergonomic handle design makes work easier and prevents occupational illnesses. Carry belt enables the simple transport of the tool case and keeps hands free for other materials. **Increases your efficiency:** A comprehensive tool assortment, always having the right tool at hand when needed. The design and function of the tool trays guarantee quick and easy access to tools. **Increases your flexibility:** Ample space for additional tools and lots of storage for small parts and machines.

**Tool set electrician Competence XL
 assorted 80-pcs. in case**

Order-No. 40523

More information: Page 110

The perfect complement:



**Torque screwdriver set TorqueVario®-S
 electric**

Order-No. 36791

More information: Page 162



E-screwdriver, set 2, speedE®

Order-No. 41912

More information: Page 20, 21, 126

Further information:



Protects your health: Recommended by doctors and therapists
Fixing by hand with a deft touch. **Offers you full protection:**
Increases your speed: Work completed twice as fast thanks to a
with protection function to prevent damage to materials (max.



at German Campaign for Healthier Backs. **Increases your control:** slimBits tested at 10,000 V AC and approved for 1,000 V AC. 3-step process. **Protects your material:** Electric screw fastening (0.4 Nm).



Wiha speedE®

E-screwdriver speedE®

- Power-assisted screw-driving halves working time.
- Thanks to the integrated material protection function, the electric assistance stops automatically at 0.4 Nm.
- Final screw tightening can then be carried out by hand.
- Recommended by doctors and therapists.
- slimBits tested at 10,000 V AC and approved for 1,000 V AC.



Increases your speed: Work completed twice as fast thanks to a 3-step process.
Protects your material: Electric screw fastening with protection function to prevent damage to materials (max. 0.4 Nm). **Increases your control:** Fixing by hand with a deft touch. **Offers you full protection:** slimBits tested at 10,000 V AC and approved for 1,000 V AC. **Protects your health:** Recommended by doctors and therapists at German Campaign for Healthier Backs.

E-screwdriver, set 2, speedE®
Mixed 13 pcs in L Boxx Mini with slimBits, easyTorque adapter, batteries and EU charger

Order-No. 41912
 More information: Page 126

Further information:



The perfect complement:



Screwdriver with bit magazine LiftUp electric

Order-No. 41234
 More information: Page 180



Flashlight with LED, laser and UV light

Order-No. 41286

More information: Page 128

Product video:



Simplifies your work: Retaining clip and magnetic positioner on the lid allows you to keep hands free for other tasks. Integrated laser makes it easier to fix position more precisely and project measurements for ceiling installations, for example. Perfect light positioning thanks to lamp head swivelling in an L shape. **Increases your safety:** Power-on time of 2 seconds prevents the laser being activated by accident. **Increases your efficiency:** Very strong LED lamp – two light intensities to adjust to light conditions as required. Includes laser and UV light.





Flashlight with LED, laser and UV light

Universal work tool with integrated laser, UV light and LED light.

- Optimum positioning and variable light direction thanks to the magnetic base and swivel head.
- The installation position can be projected directly from the middle of a table when fitting lights to the ceiling.
- The integrated UV light is ideal for finding misplaced coloured fluorescent Wiha tools and for technical inspections.

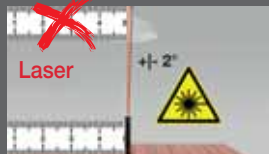

Torque QuickCheck

Wiha Torque QuickCheck

- The Wiha torque screwdriver can quickly and easily test torque screwdrivers to check the precision of the configured torque value before each use.
- Checking tools regularly ensures reliable, precise work.
- The device offers user-friendly operation, clear test readings and easy to understand LED traffic light signals.
- Thanks to a compact, handy shape, it is the ideal companion when out on jobs.
- Suitable for all Torque Vario®-S and iTorque® torque screwdrivers whose torque range included 2.8 Nm.





Torque QuickCheck torque testing device

Order-No. 42086

More information: Page 129

Product video:



Increases your safety: Checking your torque tool regularly guarantees safe, precise work with the correct torque. **Saves time:** LED traffic light system displays results in a way which is quick and easy to understand. **Increases your efficiency:** Fast, easy checking of your torque tool thanks to mobile, compact shape.



Simplifies your work: All tools securely arranged in a robust and ensure good, protected access to deep-set screws. **Increases** you space. **Offers you full protection:** Each tool individually



**Screwdriver and bit set slimVario®
screwdriver**

Order-No. 41231

More information: Page 132

Product video:



clearly laid out bag. **Increases your safety:** Wiha slimBits
your efficiency: Extensive interchangeable blade system saves
tested at 10,000 V AC and approved for 1,000 V AC.



**Screwdriver set SoftFinish®
electric slimFix**

Order-No. 41003

More information: Page 133

Further information:



Increases your safety: Wiha slim blades ensure unlimited, With the patented SoftFinish® handle design, ensuring work therapists at German Campaign for Healthier Backs. **Increases** balance of torque and control. **Offers you full protection:** 1,000 V AC.



protected access to deep-set screws. **Protects your health:** is kind to hands and muscles. Recommended by doctors and **your efficiency:** Unique Wiha handle-length concept for optimum Each tool individually tested at 10,000 V AC and approved for



Increases your safety: Wiha slim blades ensure unlimited, protected access to deep-set screws. **Protects your health:** With the patented SoftFinish® handle design, ensuring work is kind to hands and muscles. Recommended by doctors and therapists at German Campaign for Healthier Backs. **Increases your efficiency:** Unique Wiha handle-length concept for optimum balance of torque and control. **Offers you full protection:** Each tool individually tested at 10,000 V AC and approved for 1,000 V AC.

Screwdriver set SoftFinish® electric slimFix
Slotted, Phillips, PlusMinus/Pozidriv
6-pcs.

Order-No. 38362

More information: Page 134

Product video:



The perfect complement:



Pliers set Professional electric

Order-No. 26852

More information: Page 252

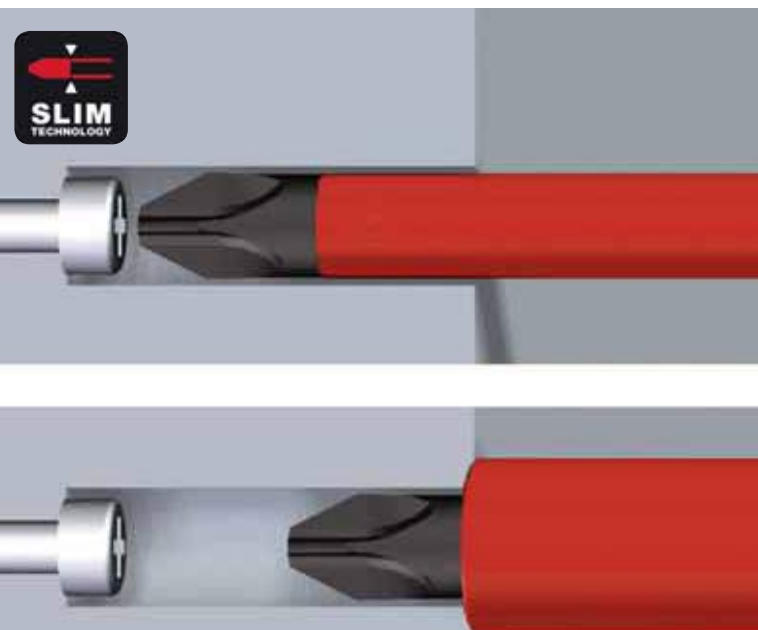

slimTECHNOLOGY

Wiha SoftFinish® electric slimFix

- Unlimited access.
- Blades up to 33 % narrower due to integrated insulation.
- Tool for spring clips (wedge-profiled output geometry).



Wiha SoftFinish® handle sizes

- Every Wiha handle optimally balances guidance, speed and torque for the respective fastening task.
- Quick-turning - Motor skills are consistently taken into consideration.
- Maximum power transmission: comfortable and loss-free transmission of physical strength, even during intensive fastening.
- The power-turning and quick-turning zones (length) vary significantly over the four handle sizes in various forms.
- The Wiha SoftFinish screwdrivers enable work that is kind on the hands and muscles and is therefore recommended by doctors and therapists from the AGR.

Combination profiles

PlusMinus.

- The special PlusMinus/Pozidriv profile is ideal for PlusMinus terminal screws.
- The combination profile reduces slipping out and guarantees a higher torque transmission.





**Screwdriver with bit holder set
SoftFinish® electric slimVario®**

Order-No. 41230

More information: Page 136

Product video:

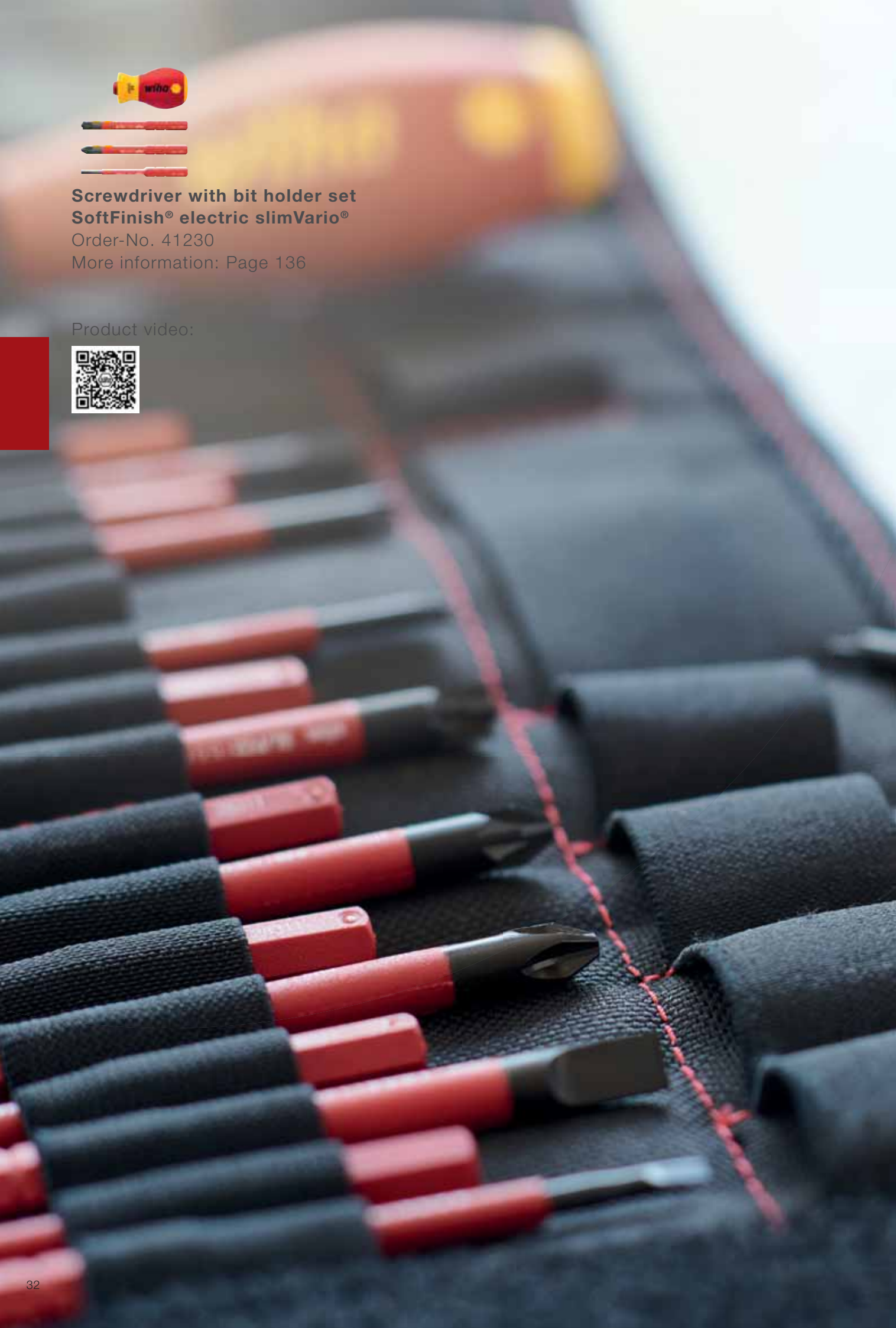

Simplifies your work: Compact handle – maximum power.
Increases your safety: Wiha slimBits ensure good, protected access to deep-set screws. Protected work in constricted spaces.
Increases your efficiency: Fully compatible with the Wiha slimBit system.
Offers you full protection: Each tool individually tested at 10,000 V AC and approved for 1,000 V AC.



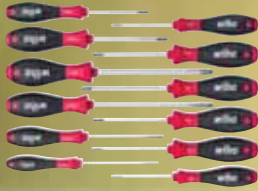

Screwdriver set SoftFinish®

Order-No. 41002

More information: Page 142

Product video:



Protects your health: With the patented SoftFinish® handle design, doctors and therapists at German Campaign for Healthier Backs. for optimum balance of torque and control.



ensuring work is kind to hands and muscles. Recommended by
Increases your efficiency: Unique Wiha handle-length concept



Simplifies your work: Standard drives and dimensions neatly stored away in a kit.
Protects your health: With the patented SoftFinish® handle design, ensuring work is kind to hands and muscles. Recommended by doctors and therapists at German Campaign for Healthier Backs.
Increases your efficiency: Unique Wiha handle-length concept for optimum balance of torque and control.

Screwdriver set SoftFinish® Slotted, Phillips 6-pcs.

Order-No. 07152

More information: Page 142

Product video:



The perfect complement:



Magnetiser

Order-No. 01508

More information: Page 154



Wiha SoftFinish® screwdriver

The convenient expert for dry applications.

- The SoftFinish handle provides optimal grip for dry applications in trade and industry.
- The position of the soft and hard zones on the handle also supports the perfect grip for quick and powerful turning.



Simplifies your work: Striking cap integrated into the handle allows you to strike and lift with the screwdriver. **Makes handling easier:** Easy loosening of tight screws thanks to hex bolster for spanners. **Protects your health:** With the patented SoftFinish® handle design, ensuring work is kind to hands and muscles. Recommended by doctors and therapists at German Campaign for Healthier Backs. **Increases your efficiency:** Unique Wiha handle-length concept for optimum balance of torque and control.

**Screwdriver set SoftFinish®
Slotted, Phillips hexagonal blade and
solid steel cap, 6-pcs.**

Order-No. 21250

More information: Page 144

Product video:



The perfect complement:



Electrician's hammer

Order-No. 42071

More information: Page 301

**Solid steel cap and hexagon
head**

- The solid steel cap at the end of the screwdriver handle enables targeted hammering, e.g. to loosen jammed screws.
- The direct connection of the solid steel cap to the blade means that the impact energy is transmitted without any loss.
- Blade includes a hexagon bolster for using a set of spanners for additional torque.





Simplifies your work: Striking cap integrated into the handle allows you to strike and lift with the screwdriver. **Increases your safety:** Anti-slip handle simplifies work in oily and wet application areas. **Makes handling easier:** Easy loosening of tight screws thanks to hex bolster for spanners. **Protects your health:** With the patented SoftFinish® handle design, ensuring work is kind to hands and muscles. Recommended by doctors and therapists at German Campaign for Healthier Backs. **Increases your efficiency:** Unique Wiha handle-length concept for optimum balance of torque and control.

Screwdriver set MicroFinish®
Slotted, Phillips with one-piece hexagonal blade and solid steel cap,
5-pcs.

Order-No. 29138

More information: Page 155

Product video:



The perfect complement:



Pliers set Professional

Order-No. 26854

More information: Page 267



Wiha MicroFinish screwdriver

The specialist for wet and oily applications.

- Due to the micro-fine surface structure of the screwdriver handle, the user can gain an optimal hold, even with oily or wet hands.
- The position of the soft and hard zones on the handle also supports the perfect grip for quick and powerful turning.



Meets your requirements: Electrostatically conductive tools protect electronic components from damage. **Protects your health:** With the patented SoftFinish® handle design, ensuring work is kind to hands and muscles. Recommended by doctors and therapists at German Campaign for Healthier Backs. **Increases your efficiency:** Screwdriver handle size concept for an optimal balance between precision and control.

Screwdriver set SoftFinish® ESD Slotted, Phillips 5-pcs.

Order-No. 27252

More information: Page 157

Product video:



The perfect complement:



Pliers set Professional ESD

Order-No. 33507

More information: Page 282

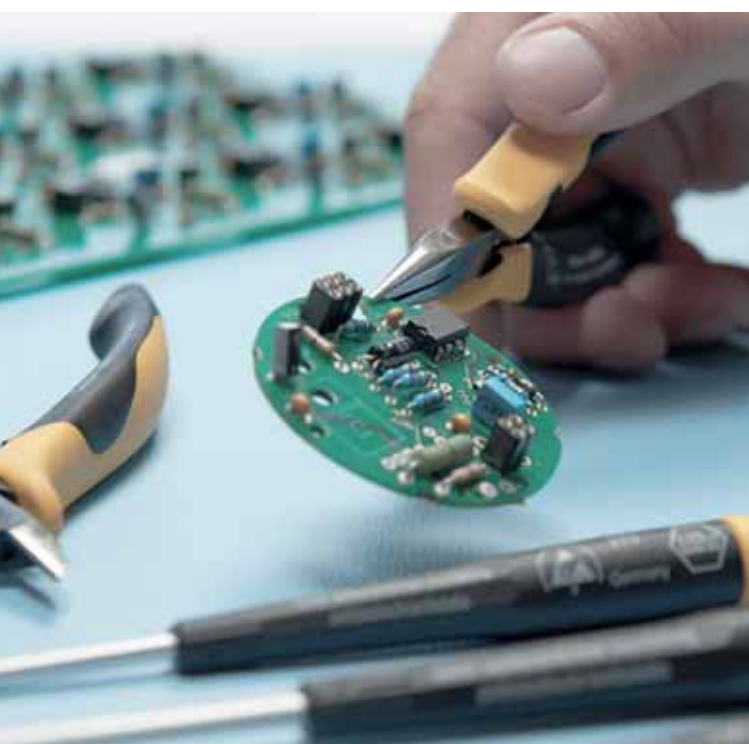

Electrostatic conductive ESD tools

Sensitive, electronic components can be damaged even at a very low voltage.

- Dissipative tools by Wiha discharge the electrostatic energy in a controlled, safe manner.
- ESD tools meet the ESD Standard IEC 61340-5-1.
- ESD tool handles have a surface resistance of $10^6 - 10^9$ Ohm.



Simplifies your work: Sensitive working due to slim handle and rotating cap. **Lowers your costs:** Electrostatically conductive tools protect electronic components from damage.

**Screwdriver set Precision ESD
Slotted, Phillips 6-pcs.**

Order-No. 08463

More information: Page 157

The perfect complement:



SMD tweezer set Professional ESD

Order-No. 32349

More information: Page 282



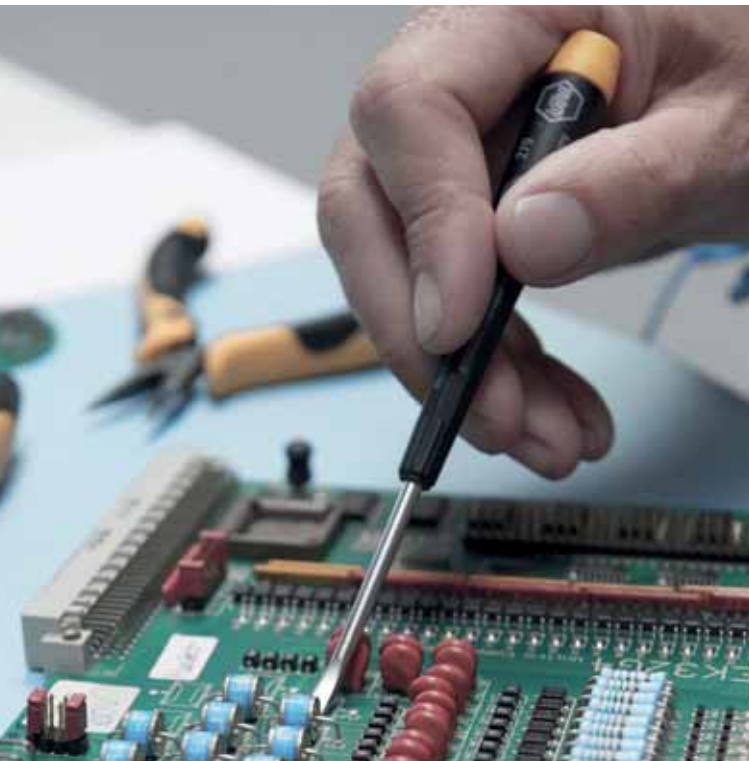

Electrostatic conductive ESD tools

Sensitive, electronic components can be damaged even at a very low voltage.

- Dissipative tools by Wiha discharge the electrostatic energy in a controlled, safe manner.
- ESD tools meet the ESD Standard IEC 61340-5-1.
- ESD tool handles have a surface resistance of 10^6 - 10^9 Ohm.

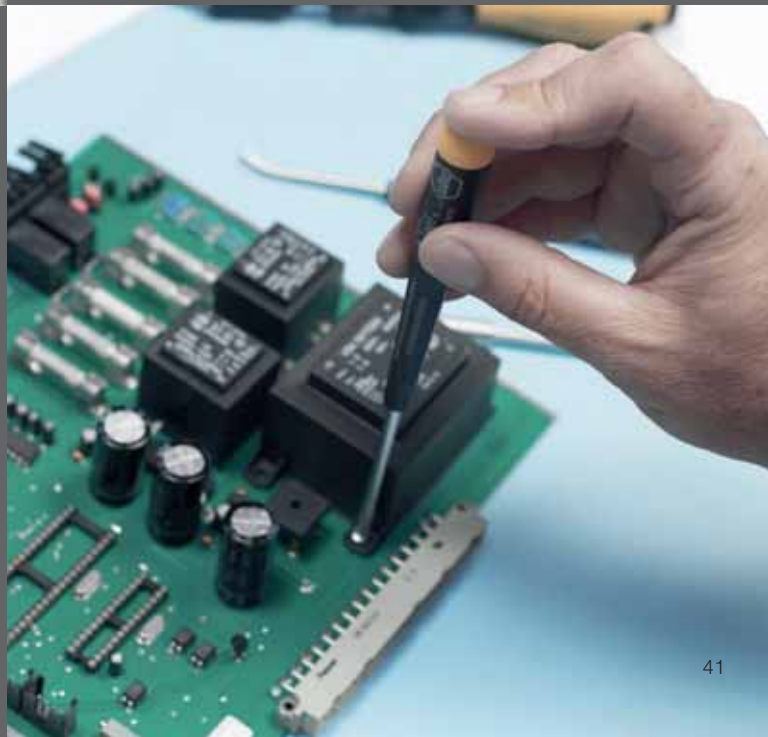



**Torque screwdriver set
TorqueVario®-S electric**

Order-No. 36791

More information: Page 162

Product video:



Meets your requirements: A variably settable torque covers a arranged in a robust and clearly laid out bag. The correct torque slimBits ensure good, protected access to deep-set screws. design, ensuring work is kind to hands and muscles. Recommended Backs. **Increases your efficiency:** The correct torque protects **full protection:** Each tool individually tested at 10,000 V AC and



large application area. **Simplifies your work:** All tools securely protects you from warranty claims. **Increases your safety:** Wiha **Protects your health:** With the patented SoftFinish® handle by doctors and therapists at German Campaign for Healthier material from damages and means no follow-up work. **Offers you** approved for 1,000 V AC.



Torque screwdriver iTorque®

Order-No. 36888

More information: Page 168

More information:



Meets your requirements: A variably settable torque covers warranty claims. **Increases your efficiency:** The correct torque **Increases your productivity:** Utmost process safety thanks to



a large application area. The correct torque protects you from protects material from damages and means no follow-up work. integrated ClickControl counting function and calibration alarm.



iTorque

The intelligent torque tool.

- Required torque can be adjusted and set on the handle without the need for a separate tool.
- Large numerical display simplifies reading.
- ClickControl records every use and optimises the monitoring of measuring instruments.
- Calibration alarm after 5,000 applications for absolute process safety.
- Certified individual item testing directly after on-site production.
- Broad selection of interchangeable blades and adapter blades.
- Units can be switched (Nm » in.lb/ cNm » in.oz)
- Can be recalibrated

TorqueVario®-S

Variably settable torque tools.

- For controlled fastening in a large range of applications.
- Torque value is continuously adjustable thanks to the torque setter adjusting tool.
- Distinctly audible and perceptible click signal when set torque is reached.
- Each Wiha screwdriver handle provides a perfectly correlated ratio of guidance, speed and torque for any fastening task.



- Certified individual item testing directly after on-site production.
- Broad selection of interchangeable blades and adapter blades.



Meets your requirements: A variably settable torque covers a large application area. **Simplifies your work:** All tools securely arranged in a robust and clearly laid out box. The correct torque protects you from warranty claims. **Protects your health:** With the patented SoftFinish® handle design, ensuring work is kind to hands and muscles. Recommended by doctors and therapists at German Campaign for Healthier Backs. **Increases your efficiency:** The correct torque protects material from damages and means no follow-up work.

Torque screwdriver set TorqueVario®-S assorted variably adjustable, 13-pcs. in box

Order-No. 26893

More information: Page 168

Product video:



The perfect complement:



Torque QuickCheck torque testing device

Order-No. 42086

More information: Page 129



Meets your requirements: A variably settable torque covers a large application area. **Simplifies your work:** All tools securely arranged in a robust and clearly laid out bag. **Lowers your costs:** The correct torque protects you from warranty claims. **Makes handling easier:** Effortless and comfortable transmission of high torques thanks to T-handle with ComfortGrip. **Increases your efficiency:** The correct torque protects material from damages and means no follow-up work.

**Torque screwdriver with T-handle set
TorqueVario®-S T
assorted, variably adjustable torque
limit, 11-pcs. in box**

Order-No. 29234

More information: Page 172

The perfect complement:



XLSelector T bit set, 25 mm

Order-No. 41830

More information: Page 224



Meets your requirements: A variably settable torque covers a large application area. **Simplifies your work:** All tools securely arranged in a robust and clearly laid out bag. **Lowers your costs:** Electrostatically conductive tools protect electronic components from damage. **Protects your health:** With the patented SoftFinish® handle design, ensuring work is kind to hands and muscles. Recommended by doctors and therapists at German Campaign for Healthier Backs. **Increases your efficiency:** The correct torque protects material from damages and means no follow-up work.

Torque screwdriver set TorqueVario®-S ESD

assorted, variably adjustable torque limit, 13-pcs. in box

Order-No. 27687

More information: Page 175

The perfect complement:



Tool set operator kit ESD

Order-No. 33504

More information: Page 123

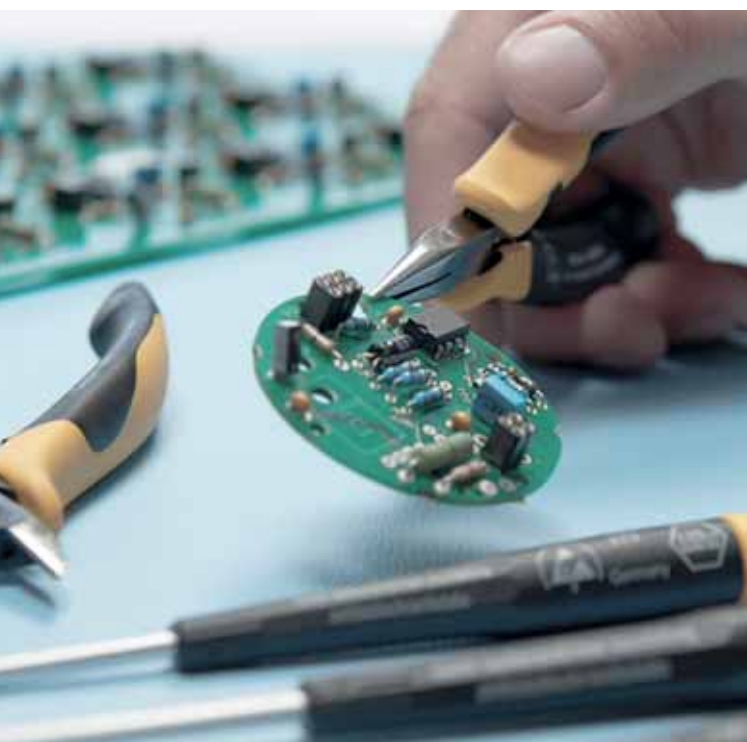

Electrostatic conductive ESD tools

Sensitive, electronic components can be damaged even at a very low voltage.

- Dissipative tools by Wiha discharge the electrostatic energy in a controlled, safe manner.
- ESD tools meet the ESD Standard IEC 61340-5-1.
- ESD tool handles have a surface resistance of $10^6 - 10^9$ Ohm.



Screwdriver with bit magazine

LiftUp electric

Order-No. 41234

More information: Page 180

Product video:



Increases your safety: Wiha slimBits ensure good, protected injury, all blades stowed safely inside the handle. **Increases your weight for 100 % efficiency.** **Offers you full protection:** Each tool



access to deep-set screws. **Protects your health:** No risk of
efficiency: Wiha LiftUp electric saves 75% volume and 50% less
individually tested at 10,000 V AC and approved for 1,000 V AC.



Screwdriver with bit magazine

LiftUp 26one®

Order-No. 40906

More information: Page 181

Product video:



Simplifies your work: Larger handle – maximum power. 26 tools bits in one tool. **Increases your efficiency:** 90% less volume,



in one. **Saves time:** Searching? Never again - the most common
85% less weight - 100% efficiency!



Saves space: Six tools in one. **Increases your efficiency:** Unrestricted access to confined spaces thanks to extremely short screwdriver handle.

**Screwdriver with bit magazine magnetic
Slotted, Phillips with 6 bits, Stubby,
1/4"**

Order-No. 33736

More information: Page 182

Product video:



The perfect complement:



**Screwdriver with bit holder set
SoftFinish® electric slimVario®**

Order-No. 41230

More information: Page 136



slimTECHNOLOGY

Wiha SoftFinish® electric slimFix

- Unlimited access.
- Blades up to 33 % narrower due to integrated insulation.
- Tool for spring clips (wedge-profiled output geometry).



Simplifies your work: The variable handle position guarantees power fastenings as well as fast fastenings. **Saves time:** Thanks to its simple operation, the desired drive can be used quickly. **Increases your efficiency:** The most common drives cleverly organized in one tool.

Multitool PocketStar assorted 9-pcs.

Order-No. 25293

More information: Page 183

Product video:



L-key set in ErgoStar holder

Order-No. 37351

More information: Page 197



PocketStar

The Multitool that fits in your pocket

- Simple and easy selection of the desired key size at the touch of a button.
- Can be used as a screwdriver long handle and T-handle.
- 270° limit for safe work prevents trapped fingers.
- Covered ends on both pivot axes prevent clothing from being caught.





Saves space: The gripper is the ideal portable space- and weight-saving alternative to a nut driver set. **Increases your efficiency:** The multifunctional gripper adapts to fit every bolt or the outer profile of screws .

**Nut driver insert gripper
3/8" in blister pack**

Order-No. 20554

More information: Page 186

More information:



The perfect complement:



Pliers set Professional

Order-No. 26854

More information: Page 267





Simplifies your work: Blade length is adjustable from 42-114 mm. **Makes handling easier:** Easy operation of the locking and unlocking button. **Protects your health:** With the patented SoftFinish® handle design, ensuring work is kind to hands and muscles. Recommended by doctors and therapists at German Campaign for Healthier Backs. **Increases your efficiency:** Compact fastening tool System 6 with comprehensive, interchangeable blade selection.

Screwdriver with interchangeable blade set SYSTEM 6 assorted 11-pcs.

Order-No. 03591

More information: Page 187

Product video:



The perfect complement:



Screwdriver with interchangeable blade set SYSTEM 6

Order-No. 27713

More information: Page 188



SYSTEM 6

Screwdriver with interchangeable blades

- Flexible, versatile interchangeable blade system in industrial quality.
- Suitable for all applications: the blades can be quickly combined, extended and exchanged.
- Press sleeve: Blade lock is released
- Desired blade length can be set (42 – 114 mm)
- Release sleeve: Blade is held in place





Simplifies your work: Blade length is adjustable from 18-90 mm. Electrostatically conductive tools protect electronic components from damage. **Makes handling easier:** Easy operation of the locking and unlocking button. **Protects your health:** With the patented SoftFinish® handle design, ensuring work is kind to hands and muscles. Recommended by doctors and therapists at German Campaign for Healthier Backs. **Increases your efficiency:** Compact precision fastening tool System 4 with comprehensive, interchangeable blade selection.

Screwdriver with interchangeable blade set SYSTEM 4 ESD assorted 11-pcs.

Order-No. 31499

More information: Page 193

The perfect complement:



Pliers set Professional ESD

Order-No. 33507

More information: Page 282

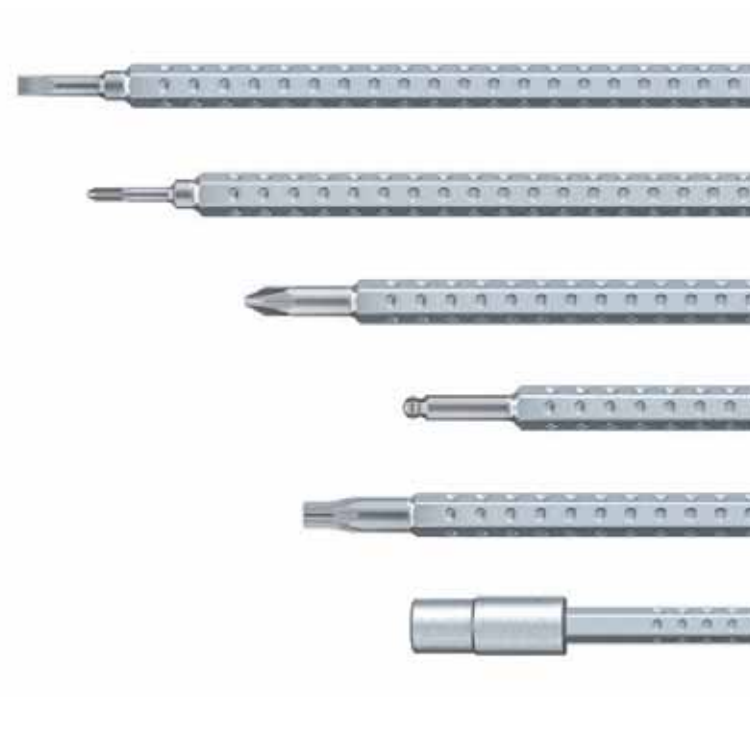

SYSTEM 4

Screwdriver with interchangeable blades

- Flexible, versatile precision interchangeable blade system for delicate fastening tasks.
- Suitable for all applications: the blades can be quickly combined, extended and exchanged.
- Press sleeve: Blade lock is released
- Press and hold sleeve: Desired blade length can be set (18 – 90 mm)
- Release sleeve: Blade is held in place



Electrostatic conductive ESD tools

Sensitive, electronic components can be damaged even at a very low voltage.

- Dissipative tools by Wiha discharge the electrostatic energy in a controlled, safe manner.
- ESD tools meet the ESD Standard IEC 61340-5-1.
- ESD tool handles have a surface resistance of 10^6 - 10^9 Ohm.

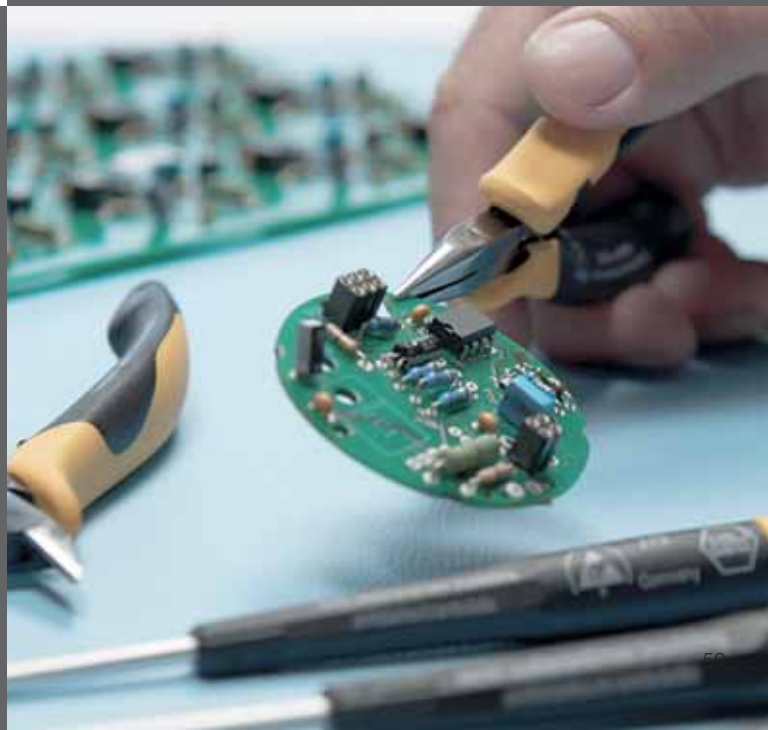

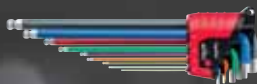

L-key set in ErgoStar holder

Order-No. 41980

More information: Page 196

Product video:



Simplifies your work: The ball end facilitates access to screws and forgetting and leaving keys inside a machine and causing damage. the ErgoStar holder. **Saves time:** Ensures order: removing and targeted Coloured L-keys quick and easy to find – also in dark environments can be quickly found thanks to colour coding. Wiha MagicRing®



allows you to work at an angle of up to 25°. Reduces the risk of
Makes handling easier: Always the right key in the right place with
insertion in the holder is child's play. **Increases your efficiency:**
thanks to fluorescent paint visible in UV light. The required key width
holding feature holds all hex screws in place without a magnet.



Simplifies your work: The ball end facilitates access to screws and allows you to work at an angle of up to 25°. **Lowers your costs:** Highly durable thanks to high-quality, chrome-plated L-key surface to prevent corrosion. **Makes handling easier:** Always the correct key when you need it. **Saves time:** Ensures order: removing and targeted insertion in the holder is child's play. **Increases your efficiency:** Wiha MagicRing® holding feature holds all hex screws in place without a magnet.

**L-key set in ErgoStar holder
MagicRing® hexagonal ball end, 9-pcs.,
matt chrome-plated in blister pack**

Order-No. 37352

More information: Page 197

Product video:



The perfect complement:



Torque screwdriver set TorqueVario®-S

Order-No. 26893

More information: Page 168



Simplifies your work: The ball end facilitates access to screws and allows you to work at an angle of up to 25°. **Makes handling easier:** Sliding function for one-handed opening of the holder and simple, quick removal. **Protects your health:** Reduction of the risk of injury by increasing the hand working space. **Increases your efficiency:** Improved accessibility thanks to its short side.

L-key set in ProStar holder Matt chrome-plated hexagonal ball end with short shaft, 9-pcs. in blister pack

Order-No. 35481

More information: Page 198

Product video:



The perfect complement:



Screwdriver set SoftFinish®

Order-No. 41002

More information: Page 142



L-key with short shaft

Especially for hard-to-reach screws and confined spaces

- Improved accessibility thanks to a 60% reduction in length of the short L-key side.
- Increase in the hand working space of over 30% and thus a reduction of the risk of injury to the knuckles and fingertips thanks to a 95° bend of the L-key.
- Ball end geometry enables fastening at an angle of up to 25°.

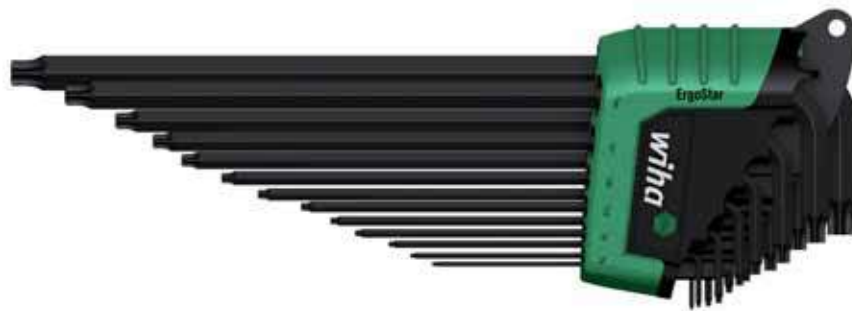

Makes handling easier: Always the correct key when you need it. **Saves time:** Ensures order: removing and targeted insertion in the holder is child's play. **Increases your efficiency:** Wiha MagicSpring® holding feature holds all Torx® screws in place without a magnet.

**L-key set in ErgoStar holder
TORX® MagicSpring®, 13-pcs. in blister
pack, black oxidised**

Order-No. 36504

More information: Page 202

Product video:



The perfect complement:



Pliers set Classic with MagicTips®

Order-No. 34708

More information: Page 267



ErgoStar

The right L-key after just one turn.

- One turn of any L-key and all L-keys are ready for removal.
- Solid stopping point for fixing L-keys in the holder.
- Innovative clamping ensures L-keys are held firmly in both a closed and open position.
- Compact design saves space on the work bench or in the toolbox.
- Wall bracket for practical storage of the ErgoStar holder in the workshop.



Simplifies your work: Effortless and comfortable transmission of high torques thanks to T-handle with ComfortGrip. **Lowers your costs:** Highly durable thanks to high-quality, chrome-plated L-key surface to prevent corrosion. **Increases your efficiency:** Integrated side drive for effortless fastening and unfastening of rusted or stubborn screws.

**L-key with T-handle set
ComfortGrip
TORX® with side drive, matt
chrome-plated 6-pcs.**

Order-No. 26248

More information: Page 204

The perfect complement:



Pliers set Classic

Order-No. 26850

More information: Page 266



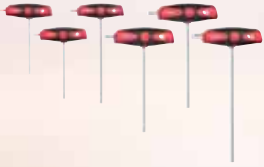

L-key with T-handle set ComfortGrip

Order-No. 26247

More information: Page 204

Product video:



Simplifies your work: Effortless and comfortable transmission of thanks to high-quality, chrome-plated L-key surface to prevent effortless fastening and unfastening of rusted or stubborn



high torques thanks to T-handle with ComfortGrip. Highly durable corrosion. **Increases your efficiency:** Integrated side drive for screws.



**FlipSelector Y bit set,
25 mm**

Order-No. 41827

More information: Page 227



**XLSelector T bit set,
50 mm**

Order-No. 41831

More information: Page 225



**BitBuddy® TY bit set,
29 mm**

Order-No. 42137

More information: Page 223

More information:



Lowers your costs Bit quick and easy to find thanks to yellow **time:** No long searches thanks to fluorescent bit, infrequent bit thanks to clear organisation and automatic opening at the push greater lifespan* thanks to optimised bit for Y-shaped screws



marking – even in dark environments by using an UV light. **Saves** replacement thanks to long lifespan. Simple and rapid bit removal of a button. **Increases your efficiency:** The specialist with 120x (*compared to Wiha standard bit)





Lowers your costs: Bit quick and easy to find thanks to yellow marking – even in dark environments by using an UV light. **Saves time:** No long searches thanks to fluorescent bit, infrequent bit replacement thanks to long lifespan. **Increases your efficiency:** The specialist with 120x greater lifespan* thanks to optimised bit for Y-shaped screws(*compared to Wiha standard bit)

**XLSelector Y bit set, 50 mm
Phillips, Pozidriv, TORX®, 13-pcs., 1/4"**

Order-No. 41834

More information: Page 226

More information:



The perfect complement:



**Bit holder CentroFix Super Slim
mechanically lockable**

Order-No. 39134

More information: Page 246



Wiha TY bit concept

Bits quickly and easily selected thanks to the screw head shape.

- The T bit is ideal for fastening T-shaped screws with an angle of 90°.
- The Y bit is ideal for fastening Y-shaped screws with an angle not equal to 90°.
- Universal in its use, the TY bit is suitable for all types of screws, no matter whether they feature a Y-shaped or T-shaped screw head.



Lowers your costs: Bit quick and easy to find thanks to blue marking – even in dark environments by using an UV light. **Saves time:** No long searches thanks to fluorescent bit, infrequent bit replacement thanks to long lifespan. Simple and rapid bit removal thanks to clear organisation and automatic opening at the push of a button. **Increases your efficiency:** The specialist with 120x greater lifespan* thanks to optimised bit for T-shaped screws(*compared to Wiha standard bit)

**FlipSelector T bit set, 25 mm
Phillips, Pozidriv, TORX®, 13-pcs.,
1/4"**

Order-No. 41824

More information: Page 225

More information:



The perfect complement:



Flashlight with LED, laser and UV light

Order-No. 41286

More information: Page 128

BITFINDER

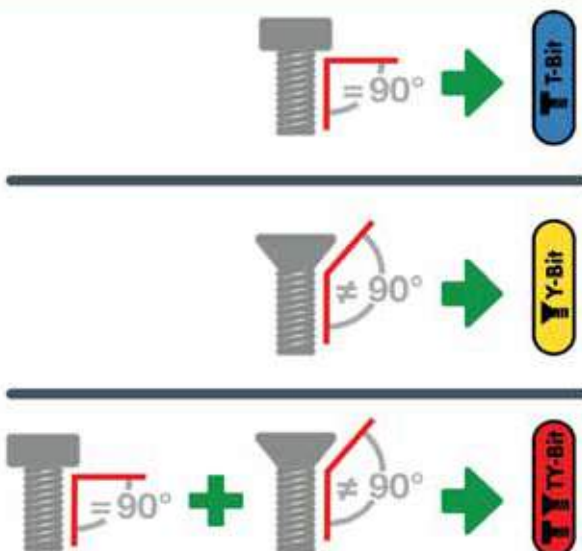



Lowers your costs: Bit quick and easy to find thanks to blue marking – even in dark environments by using an UV light. **Saves time:** No long searches thanks to fluorescent bit, infrequent bit replacement thanks to long lifespan. **Increases your efficiency:** The specialist with 120x greater lifespan* thanks to optimised bit for T-shaped screws (*compared to Wiha standard bit)

XLSelector T bit set, 50 mm
Phillips, TORX®, hex 13-pcs. 1/4"
 Order-No. 41831
 More information: Page 224

More information:



The perfect complement:



Screwdriver with LiftUp 25 magnetic bit magazine

Order-No. 38606
 More information: Page 181

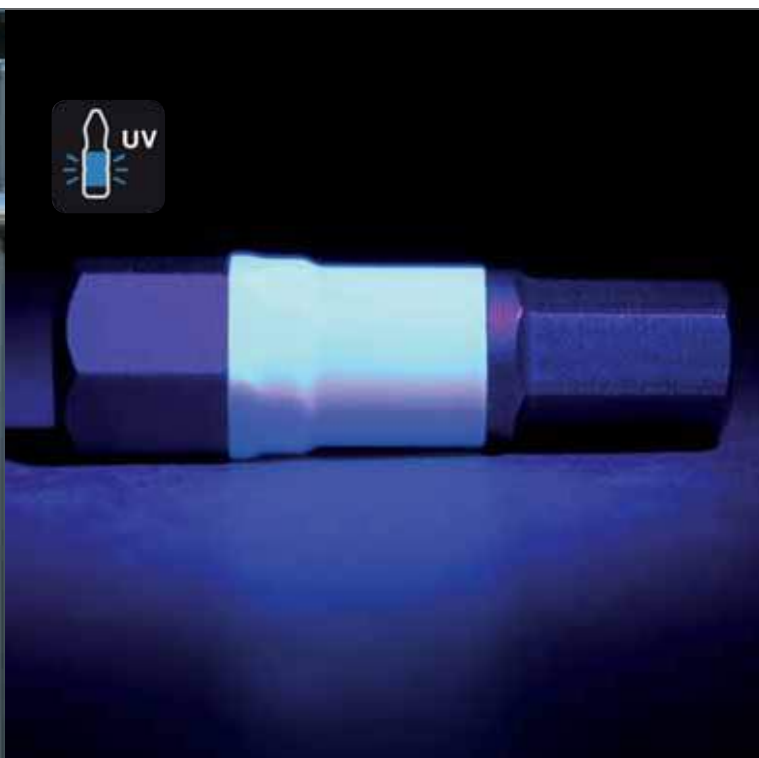



Lowers your costs: Bit quick and easy to find thanks to red marking – even in dark environments by using an UV light. **Saves time:** No long searches thanks to fluorescent bit, infrequent bit replacement thanks to long lifespan. Automatic opening at the push of a button and simple bit change directly in the holder. **Increases your efficiency:** The all-rounder with 120x greater lifespan* thanks to patented bit technology, suitable for all screws. (*compared to Wiha standard bit)

BitBuddy® TY bit set, 29 mm
Phillips, Pozidriv, TORX®, 8-pcs., 1/4"
 Order-No. 42137
 More information: Page 223

More information:



The perfect complement:



Bit holder CentroFix Force
mechanically lockable
 Order-No. 39133
 More information: Page 246



BitBuddy 29

Easy, single-hand operation.

Attaching:

- Bits are directly picked up with the machine from the BitBuddy.

Work:

- Gets your fastenings done.

Storing

- Bits are easily returned to the BitBuddy, by pressing on the red bit strip.
- With magnetic bit holder for a rapid bit change.
- BitBuddy is always at hand - easily fits into trouser pockets or onto the belt clip.





Lowers your costs: Bit quick and easy to find thanks to red marking – even in dark environments by using an UV light. **Saves time:** No long searches thanks to fluorescent bit, infrequent bit replacement thanks to long lifespan. Automatic opening at the push of a button and simple bit change directly in the holder. **Increases your efficiency:** The all-rounder with 120x greater lifespan* thanks to patented bit technology, suitable for all screws. (*compared to Wiha standard bit)

BitBuddy® TY bit set, 49 mm TORX® 1/4" 7-pcs.

Order-No. 42115

More information: Page 222

More information :



The perfect complement:



L-key set in ErgoStar holder

Order-No. 41980

More information: Page 196



Bit holder MagicFlip Force magnetic

Order-No. 36800

More information: Page 246

Product video:



Simplifies your work: Actuating sleeve recoils to indicate flush fastening. **Increases your safety:** Thanks to the strong ring magnet, even heavy screws are held securely in place.





Saves time: Rapid bit change due to easy-to-operate locking and unlocking of the holder. **Increases your efficiency:** No wobbling and an extremely secure hold thanks to the play-free guidance of bits.

Bit holder CentroFix Force mechanically lockable

1/4", magnetic

Order-No. 39133

More information: Page 246

Product video:



Saves time: Automatic bit locking mechanism upon insertion. **Increases your efficiency:** Unlimited access to deep-set screws thanks to extreme slimline design.

Bit holder CentroFix Super Slim mechanically lockable

1/4", magnetic

Order-No. 39134

More information: Page 246

Product video:





CentroFix Force

- CentroFix Force
- Suitable for all bits with 1/4" hex drive style C6.3 and E6.3.
- SelfLock: The bit is locked mechanically and held securely when inserted.
- EasyOut: When unlocked, the bit moves into the ideal removal position.

CentroFix SuperSlim

- Up to 30% reduced outer diameter compared to "conventional" quick release holders.
- Improved screw accessibility in confined holes.
- SelfLock: The bit is locked mechanically and held securely when inserted.
- EasyOut: When unlocked, the bit moves into the ideal removal position.



MagicFlip Force

- Facilitates the fastening of long wood screws.
- Optimal holding force thanks to extremely powerful Neodym ring magnet.
- FlipBack: The actuating sleeve automatically springs back during recessing.
- Magnet On/Off: The ring magnet can be "deactivated" by pushing the actuating sleeve back.

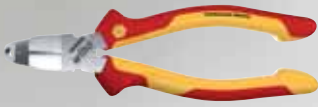

**Installation pliers TriCut
Professional electric**

Order-No. 38552

More information: Page 253

Product video:



Simplifies your work: The angled head allows you to work in need one tool for three tasks: cutting to length, stripping and 60% volume and 50% less weight for 100% efficiency. **Offers you** approved for 1,000 V AC.



hard-to-reach places such as installation sockets. Now you only skinning. **Increases your efficiency:** Three tools in one. Saves **full protection:** Each tool individually tested at 10,000 V AC and



Lowers your costs: Durable thanks to high-quality, chromed plier surface to prevent corrosion. **Increases your safety:** Wiha combination pliers enable safe, non-slip gripping in all work situations. **Protects your health:** Special DynamicJoint® design reduces effort required for cutting. **Increases your efficiency:** Wiha needle nose pliers with extra-long plier head for inserting low-lying components. **Offers you full protection:** Each tool individually tested at 10,000 V AC and approved for 1,000 V AC.

**Pliers set Professional electric
Combination pliers, needle nose pliers,
diagonal cutters 3-pcs.**

Order-No. 26852

More information: Page 252

The perfect complement:

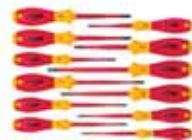

**Screwdriver set SoftFinish® electric
slimFix**

Order-No. 41003

More information: Page 133





Lowers your costs: Durable thanks to high-quality, chromed plier surface to prevent corrosion. **Protects your health:** Requires less force and reduces pressure on the wrists. **Increases your efficiency:** Two pliers in one - 200 % power at the touch of a button, available at any time. **Offers you full protection:** Each tool individually tested at 10,000 V AC and approved for 1,000 V AC.

BiCut® Professional electric high-performance diagonal cutters with DynamicJoint®, switchable

Order-No. 38191

More information: Page 254

Product video:



The perfect complement:



Screwdriver and bit set slimVario® screwdriver

Order-No. 41231

More information: Page 132





VDE-certified tools

Insulated tools are essential for all work on or around live components.

- Wiha VDE-tested tools are subject to stringent safety test procedures.
- All tools with the special marking have been tested at 10,000 V AC and are therefore approved for use at 1,000 V AC and 1,500 V DC.
- Certified by the VDE Testing and Certification Institute and individually tested according to the international standard IEC 60900.

The following equipment is required for all work on or around live components and should be appropriate for the specific task

- insulating personal protective equipment
- insulating safety mechanisms
- insulated tools

Before starting work, you must disconnect all active, live components of electrical machines and equipment and ensure that they remain disconnected while you carry out the work.

This is achieved by complying with the five safety rules:

- disconnect
- secure against reconnection
- ensure power is switched off
- earth and short-circuit
- cover or block off adjacent live components



Saves money: Two tools in one for cutting to length and skinning. **Protects your health:** Ergonomic handling enables users to work longer whilst protecting muscles. **Offers you full protection:** Each tool individually tested at 10,000 V AC and approved for 1,000 V AC.

Needle nose pliers Inomic® VDE with cutting edge and stripping points

Order-No. 33259

More information: Page 257

The perfect complement:



Fine screwdriver set PicoFinish® electric

Order-No. 42989

More information: Page 136

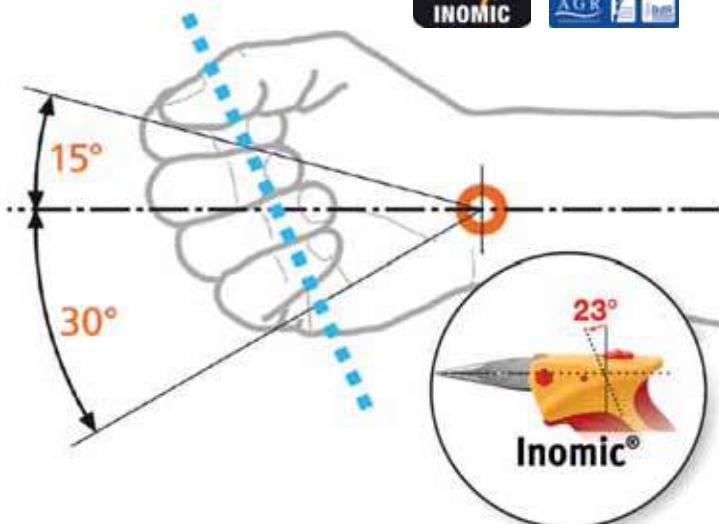

Wiha Inomic®

Innovative and ergonomic.

- The angled shape of the Inomic® pliers enables work which is kind on the hands and muscles and is therefore recommended by doctors and therapists from the AGR.
- Improved grip control due to highly sensitive opening spring.
- Like an extension of your own hand: gripping is simple, firm and safe.
- Pliers can be transported and stored in a closed position, thanks to a locking mechanism.





Automatic crimp tool

Order-No. 41246

More information: Page 265

Product video:



Lowers your costs: An integrated lever enables users to interrupt
your safety: Safe work through feed aid prevents crimping the
Thanks to hexagonal crimping, small wire-end sleeves no longer
of wire-end sleeve size with suitable crimping force for a large



the crimping process at any time to protect the pliers. **Increases** plastic cover of wire-end sleeves. **Makes handling easier:** get caught. **Increases your efficiency:** Automatic adjustment coverage area of 0.08-16mm².



Lowers your costs: Long-lasting and robust thanks to metal blade insert. **Protects your health:** Damper enclosed for large cable cross-sections to reduce recoil and protect wrists. **Saves time:** Blades quickly exchanged by immediately available replacement blades in the handle. **Increases your efficiency:** Automatic stripping pliers for a wide range of cables between 0.03 and 16 mm².

Stripping tool automatic up to 16 mm² in blister pack

Order-No. 42062

More information: Page 262

Product video:



The perfect complement:



Torque screwdriver set TorqueVario®-S electric

Order-No. 36791

More information: Page 162



Stripping tool, automatic up to 16mm²

- These pliers can handle a wide range of cables, thus combining two pairs of pliers in one.
- The supplied damper can be used to lessen recoil caused by larger cable gauges, such as those greater than 6 mm², thus helping to protect wrists.
- Precise cutting to length thanks to adjustable longitudinal stop.
- Integrated hand protection along the cutting edge guards against injury.



Lowers your costs: Durable thanks to high-quality, chromed plier surface to prevent corrosion. **Increases your safety:** Wiha combination pliers enable safe, non-slip gripping in all work situations. **Makes handling easier:** Wiha QuickFix water pump pliers with simple and rapid opening width setting, especially during constantly changing applications. **Protects your health:** Special DynamicJoint® design reduces effort required for cutting.

Pliers set Professional
High-leverage combination pliers, water pump pliers, heavy-duty diagonal cutters, 3-pcs.

Order-No. 26854

More information: Page 267

The perfect complement:



Screwdriver set MicroFinish®

Order-No. 29138

More information: Page 155



Automatic crimp tool

- Process-safe hexagonal crimping prevents smaller wire-end sleeves from snagging.
- These crimping pliers can handle all standard applications with a crimping range between 0.08 and 16 mm².
- Suitable for both single wire-end sleeves and twin wire-end sleeves thanks to automatic crimping.





Pliers wrench Classic

Order-No. 40923

More information: Page 275

Product video:



Simplifies your work: Self-locking at AF 17 and above. Also
Lowers your costs: Minimises wear and prevents damage to
free handling. **Saves space:** Replaces a set of metric and imperial
bending tasks take minimum effort thanks to manual force increased
with no need to press any buttons. Ratchet function allows users
Slender design thanks to button-free setting enables it to be used



suitable for left-handed users as operated without side push button. sensitive surfaces thanks to smooth, parallel jaws and backlash-open-ended spanners. **Protects your health:** Compaction and tenfold. **Saves time:** Safe, rapid setting directly on the work piece to fasten screws instantly with a simple glide. **Improved access:** in confined working environments, minimising the risk of damage.



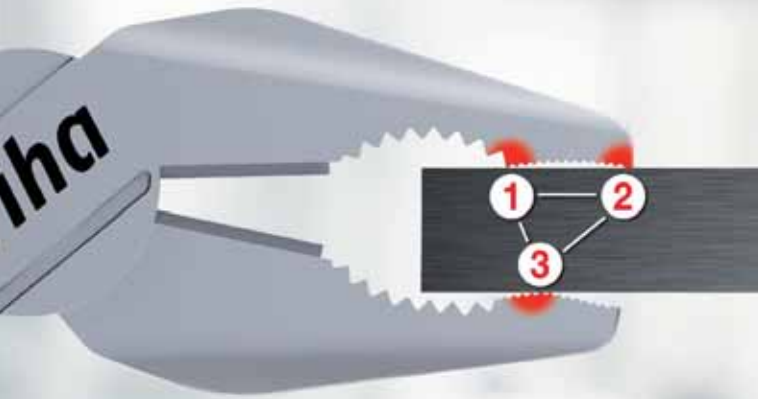

OptiGrip

Wiha OptiGrip – optimal grip due to newly designed gripping surfaces

- A firm hold: The „triple-point support“ protects the workpiece from twisting or slipping.
- Highly effective: Optimum grip even with large jaw opening – and at the same time significantly less force needed.
- A wide selection: Now in standard Wiha combination pliers and high leverage combination pliers.

DynamicJoint®

Wiha DynamicJoint® – A new dimension in strength and durability

- Innovative: Optimised joint construction.
- Effective: Minimal power loss means less force needed for cutting.
- Permanent: Optimal performance even after thousands of cuts.



MagicTips®

Wiha MagicTips® – Top of their class.

- Maximum grip: The special latching function preventing jumping away of the safety rings makes the Wiha circlip pliers truly unique.
- Hard as steel: Additional hardening of tips means high wear resistance and therefore excellent durability.
- Precise: Precision tips of high performance steel for maximum grip and high stability.



Lowers your costs: Prevents damage caused by lost circlips in the work area. **Saves time:** Safe and sturdy grip on circlips.

**Pliers set Classic with MagicTips®
Circlip pliers 4-pcs.**

Order-No. 34708

More information: Page 267

Product video:



The perfect complement:



**Screwdriver with interchangeable
blade set SYSTEM 6**

Order-No. 00623

More information: Page 187





Lowers your costs: Durable thanks to high-quality, chromed plier surface to prevent corrosion. **Protects your health:** Requires less force and reduces pressure on the wrists. **Increases your efficiency:** Two pliers in one - 200 % power at the touch of a button, available at any time.

Professional BiCut® high-performance diagonal cutters with DynamicJoint® Switchable

Order-No. 38190

More information: Page 268

Product video:



The perfect complement:



Screwdriver set SoftFinish®

Order-No. 41002

More information: Page 142



Meets your requirements: Universal set for various cutting applications, secure hold and feeding in the electronics sector. **Lowers your costs:** Electrostatically conductive tools protect electronic components from damage.

Pliers set Professional ESD
Diagonal cutters, oblique end cutting nippers, needle nose pliers 4-pcs.

Order-No. 33507

More information: Page 282

The perfect complement:



Screwdriver handle SoftFinish®-telescopic ESD

Order-No. 31498

More information: Page 189



Electrostatic conductive ESD tools

Sensitive, electronic components can be damaged even at a very low voltage.

- Dissipative tools by Wiha discharge the electrostatic energy in a controlled, safe manner.
- ESD tools meet the ESD Standard IEC 61340-5-1.
- ESD tool handles have a surface resistance of 10^6 - 10^9 Ohm.



Simplifies your work: Dirt- and dust-free work compared to when the handle prevents a discharge between the striking cap and the using a hammer at any time, even near power sockets. **Saves** how near you are to wall sockets. **Increases your efficiency:** measurement. Perfectly dimensioned dowel hole thanks to blade



SoftFinish® dowel racket set with dowels

Order-No. 41289

More information: Page 301

Product video:



machines are used. **Increases your safety:** Galvanic separation in blade. **Protects your health:** Dowel hole can be made anywhere **time:** Hammer dowel holes anywhere at any time without worrying Scaled impact screwdriver blade provides more detailed depth adjusted to required size.





Electrician's hammer

Order-No. 42071

More information: Page 301

Product video:



Simplifies your work: Flat claws allow you to remove nails and nail clamps easily. **Increases your efficiency:** Perfect balance thanks to optimum weight distribution for effective handling. **Improved access:** Perfectly suited for use in confined working environments thanks to the combination of a square and round head shape. **Increases the quality of your work:** The flat surface on the hammer handle ensures cables and dowels are fitted into position without causing any damage.





Meets your requirements: Hammer components in a practical Wiha safety set with replaceable hammer heads of various degrees of hardness for all applications. **Simplifies your work:** Makes work easier, optimum impact effect and less effort needed. Each hammer component is available individually as a spare part. **Increases your efficiency:** Perfect finishing on rough edges thanks to the square hammer face with 27% more impact surface.

**Soft-faced hammer set Safety
with assorted hammer faces, 8-pcs. in
box**

Order-No. 28050

More information: Page 294

The perfect complement:



Electrician's spirit level

Order-No. 42074

More information: Page 302



Meets your requirements: Yellow hammer head / medium-hard: e.g. for tool and machine engineering, car repairs, sheet metal and assembly work. **Simplifies your work:** Makes work easier, optimum impact effect and less effort needed. **Protects your health:** Deadblow Hammering without recoil minimises loads on joints, tendons and muscles.

Soft-faced hammer dead-blow, medium hard
With steel tube handle, round hammer face

Order-No. 02122
 More information: Page 299

The perfect complement:



L-key set in ErgoStar holder

Order-No. 41980
 More information: Page 196



No-recoil soft-faced hammer

- The special metal filling in the hammer head prevents recoil.
- Approx. 25% more hammer head mass provides additional power.
- Preserves delicate surfaces and edges through high-impact effect.



Simplifies your work: Comfortable measurement in different when viewed from above. **Saves space:** Perfectly portable; fits 4 flush boxes. **Increases your efficiency:** Both bubbles can be



Electrician's spirit level

Order-No. 42074

More information: Page 302

Product video:



work positions thanks to the ingeniously positioned scales, even into Wiha cases. **Saves time:** Variable distance marks for up to seen easily even from an acute angle.







SoftFinish® dowel racket set with dowels

- Makes it easier to insert dowels and saves valuable working time.
- Ensures dirt- and dust-free work compared to machines.
- Galvanic separation between the blade and solid steel cap protects against electric shock.
- Perfect for portable use since you can make dowel holes anywhere at any time at the strike of a hammer.

Electrician's hammer

- With its optimally uniform weight distribution, this hammer ensures perfect balance, delivering impact and fatigue-free work.
- Its flat claws make it easier to remove fastening components such as nail clamps, even from difficult-to-access spots.
- Optimum access into corners and confined spaces thanks to U-shaped striking surface.
- The flat hammer handle lower surface acts as a soft-faced hammer, ensuring components such as cables and dowels are fixed into position without causing damage.



Electrician's spirit level, 40 cm

- Quick, easy marking of positions for up to four flush boxes in just one simple work step thanks to the integrated marking points.
- The continuous housing allows users to mark lines without interruption.
- An additional scale on the upper surface ensure precise measurement even when viewing from above.
- The bubbles are clearly visible, even from a sharp angle.
- The level is perfectly suitable for portable use thanks to its compact design.



Content

Competence XXL II electrician's tool set
Page 108



Tool set service technician
Page 112



Tool set electrician
Page 113



Tool set electrician
Page 116



E-screwdriver, set 2, speedE®
Page 126



Flashlight with LED, laser and UV light
Page 128



Torque QuickCheck torque testing device
Page 129



Screwdriver and bit set slimVario® screwdriver
Page 132



Screwdriver SoftFinish® electric slimFix
Page 138



Screwdriver SoftFinish®
Page 146



Fine screwdriver PicoFinish
Page 152



Torque screwdriver set TorqueVario®-S electric
Page 162



Torque screwdriver TorqueVario®-S electric
Page 163



Torque screwdriver with T-handle TorqueVario®-S T electric
Page 165



Torque screwdriver iTorque®
Page 168



Screwdriver with bit magazine LiftUp electric
Page 180



Screwdriver with bit magazine LiftUp 26one®
Page 181



Multitool PocketStar
Page 183



Nut driver insert gripper
Page 186



L-key set in ErgoStar holder
Page 196



L-key set in ProStar holder
Page 198



L-key set in ProStar holder
Page 198



L-key set in ErgoStar holder
Page 202



BitBuddy® TY bit set, 29 mm
Page 223



XLSelector T bit set, 50 mm
Page 224



TY bit set 29 mm
Page 224



T bit set, 25 mm
Page 225



Installation pliers TriCut Professional electric
Page 253



Combination pliers Professional electric with DynamicJoint® and OptiGrip
Page 256



Stripping tool automatic
Page 262



Automatic crimp tool
Page 265



Soft-faced hammer Safety soft/medium hard
Page 295



Soft-faced hammer dead-blow, medium hard
Page 196



Electrician's hammer
Page 301



SoftFinish® dowel racket set with dowels
Page 301



Ratchet wrench set insulated 3/8"
Page 117



Tool set mechanic
Page 121



Tool set ESD
Page 123



Ranges
From page 106

Screwdriver MicroFinish®
Page 155



Screwdriver SoftFinish® ESD
Page 158



Electro
From page 124

Torque screwdriver TorqueVario®-S
Page 168



Torque screwdriver with T-handle TorqueVario®-S T
Page 172



Torque screwdriver TorqueVario®-S ESD
Page 175



Screwdrivers
From page 130

Screwdriver with interchangeable blade set SYSTEM 6
Page 187



Screwdriver with interchangeable blade set SYSTEM 4
Page 191



Screwdriver with interchangeable blade set SYSTEM 4 ESD
Page 193



Multitools
From page 178

L-key set in ProStar holder
Page 203



L-key with T-handle ComfortGrip
Page 204



L-key with key handle
Page 206



L-keys
From page 194

Y bit set, 25 mm
Page 236



Bit Professional 1/4"
Page 236



Bit holder CentroFix Force mechanically lockable
Page 246



Bits
From page 220

Professional BiCut® high-performance diagonal cutters with DynamicJoint®
Page 268



Pliers wrench Classic
Page 275



Circlip pliers Classic with MagicTips®
Page 278



Pliers
From page 250

Electrician's spirit level
Page 302



Electrician's Longlife® folding ruler, 2 m
Page 303



Striking and measuring tools
From page 292

Information
From page 304



Ranges

Designed for those who work with it.

The experiences of the user are taken into account right from the product development stage at Wiha tools. This ensures high-quality tool sets are designed for mechanics, electricians and electronics technicians which have been specifically compiled for their particular requirements and applications. Neatly stored and clearly organised in robust, compact tool bags, tools are ready at hand, ensuring work is completed easily and efficiently.

Wiha tools prove to be very handy, essential companions stored in a Wiha tool case, where the limitations of conventional tool cases have been eliminated: thanks to its practical tool pockets and extra storage space for small parts, the Wiha tool case provides simple, strain-free transport of your tools, offering greater convenience to make your work easier in every respect.

Application Ranges

For applications in
electrics



**Competence XXL II
electrician's tool set
assorted in case 115-pcs.**
Page 108



**Tool set electrician
Competence XL
assorted 80-pcs. in case**
Page 110



**Tool set service technician
assorted 29-pcs. in bag**
Page 112



**Tool set electrician
assorted 31-pcs. in bag**
Page 113



**Tool set electrician
assorted 12-pcs. in bag**
Page 113



**Tool set electrician
screwdriver, diagonal
cutters, 6-pcs. in bag**
Page 114



**Tool set electrician
assorted slotted, Phillips,
10-pcs. in belt pouch**
Page 116



**Bit set for mounting,
19-pcs. in bag**
Page 115



**Ratchet wrench set
insulated 1/2"
20-pcs. in case**
Page 117



**Ratchet wrench set
insulated 3/8"
20-pcs. in case**
Page 117



**Single open-end spanner
set, insulated 6-32 mm
20-pcs. in case**
Page 118



For applications in
mechanics



**Tool set mechanic
assorted 31-pcs. in bag**
Page 121



**Tool set mechanic
screwdriver, combination
pliers, 6-pcs. in bag**
Page 122



Tool set operator kit ESD
Page 123



**Tool set ESD
Pliers, screwdriver,
tweezers, 9-pcs. in bag**
Page 123



For applications in
electronics





assorted in case 115-pcs.

9300-704

Order-No.

42069



1

Fastening / jamming

- ⊖ ⊕ ⊕ ⊕ ⊕ Torque screwdriver set TorqueVario®-S electric (36791) 0,8 - 5,0 Nm
 1 x Torque screwdriver TorqueVario®-S electric Variable torque limit settings / 1 x Adjusting tool for torque screwdriver with long handle /
 1 x slimBit bit holder electric, locked mechanically For VDE torque screwdriver with long handle
 1 x 2,5 / 1 x 3,5 / 1 x 5,5 / 1 x 6,5 / 1 x PH1 / 1 x PH2 / 1 x PZ1 PZ2 / 1 x SL/PZ1 / 1 x SL/PZ2 / 1 x T9 / 1 x T10 / 1 x T15 / 1 x T20 / 1 x T25
- Screwdriver with bit magazine LiftUp electric (41234)
 1 x 2,5 / 1 x 3,5 / 1 x 5,5 / 1 x PZ1 PZ2 / 1 x SL/PZ2
- Screwdriver with bit holder SoftFinish® electric slimVario Stubby for slimBits, Tool tested at 10,000 V AC (41229)
- ⊕ Bit slimBit electric Pozidriv, Tool tested at 10,000 V AC / PZ2 x 75 (34586)
- ⊖ Screwdriver SoftFinish® electric slimFix Slotted, Tool tested at 10,000 V AC / 3,5 x 100 (35446) / 5,5 x 125 (35391) / 6,5 x 150 (35392)
- ⊕ Screwdriver SoftFinish® electric slimFix Phillips, Tool tested at 10,000 V AC / PH1 x 80 (35393) / PH2 x 100 (35394)
- ⊕ Screwdriver SoftFinish® electric slimFix Pozidriv, Tool tested at 10,000 V AC / PZ1 x 80 (35395) / PZ2 x 100 (35396)
- ⊕ Screwdriver SoftFinish® electric slimFix PlusMinus/Pozidriv, Tool tested at 10,000 V AC / SL/PZ1 x 80 (36329) / SL/PZ2 x 100 (36330)
- ⊕ Screwdriver SoftFinish® electric slimFix TORX® Tamper Resistant (with hole), Tool tested at 10,000 V AC / T10H x 100 (41141) / T15H x 100 (41142) / T20H x 100 (41143) / T25H x 125 (41144)
- Screwdriver SoftFinish® electric Hex nut driver, Tool tested at 10,000 V AC / 5,5 x 125 (00856) / 7 x 125 (00858) / 8 x 125 (00859) / 10 x 125 (00861) / 13 x 125 (00864)
- ⊕ Fine screwdriver PicoFinish electric Phillips, Tool tested at 10,000 V AC / PH0 x 60 (38880)
- ⊖ Fine screwdriver PicoFinish electric Slotted, Tool tested at 10,000 V AC / 2,5 x 60 (38876)
- ⊖ ⊕ ⊕ ⊕ ⊕ Switch cabinet key pen shape in blister pack 5-8 x 9 (39076)
- ⊖ Screwdriver SoftFinish® Slotted with one-piece hexagonal blade and solid steel cap 3,5 x 75 (03223) / 12,0 x 200 (03231)

- ⊕ ⊕ ⊕ XLSelector Y bit set, 25 mm (41832)
1 x PH1 / 1 x PH3 / 2 x PZ1 / 4 x PZ2 / 2 x PZ3 / 2 x T10 / 3 x T15 / 4 x PH2 / 3 x T20 / 3 x T25 / 3 x T30 / 2 x T40 / 1 x Bit holder
magnetic extra strong magnet, 1/4"
- L-key set in ErgoStar holder (41979)
1,5 / 2 / 2,5 / 3 / 4 / 5 / 6 / 8 / 10

Trimming / cutting

- ⚡ Professional BiCut® high-performance diagonal cutters with DynamicJoint® Switchable, Tool tested at 10,000 V AC / 200mm, 8" (38191)
- ⚡ Diagonal cutters Professional electric with DynamicJoint®, Tool tested at 10,000 V AC / 160mm, 6 1/2" (26741)
- ⚡ Cable cutter Professional electric, Tool tested at 10,000 V AC / 200mm, 8" (34744)
- ⚡ Precision mechanic's diagonal cutters Classic with opening spring 125mm, 5" (36189)

Supplying / holding

- Combination pliers Professional electric with DynamicJoint® and OptiGrip with extra long cutting edge, Tool tested at 10,000 V AC / 180mm, 7" (26708)
- Needle nose pliers Professional electric with cutting edge curved shape, approx. 40°, Tool tested at 10,000 V AC / 200mm, 8" (26729)
- Needle nose pliers Professional electric with cutting edge straight shape, Tool tested at 10,000 V AC / 200mm, 8" (26727)
- Water pump pliers Professional electric with push button adjustment, Tool tested at 10,000 V AC / 250mm, 10" (37450)

Stripping/ insulating / crimping

- ⚡ Installation pliers TriCut Professional electric 170mm, 7" (38552)
Stripping tool with self-rotating trailing blade 165mm, 6 1/2" (35969)
Stripping tool automatic up to 16 mm² in blister pack 200mm, 8" (42062)
- Automatic crimp tool for wire-end sleeves hex crimping 210mm, 0,08-16mm² (41246)
- Crimp tool for insulated cable eyes and contacts 220mm, 0,5-6mm² (33841)
- ⚡ Shear for electricians with crimp function in blister pack 160mm, 50mm² (41923)

Surveying/marketing/measuring/checking

- Voltage tester Volt Detector non-contact, single-pole, 230-1,000 VAC (37871)
- Voltage tester SoftFinish® single-pole, 110-250 volts (34745)
- Flashlight with LED, laser and UV light in blister pack, including 3 AAA batteries 100 / 310 lm x 390 - 400 nm (41286)
- Electrician's spirit level 40 cm (42074)
- Electrician's Longlife® folding ruler, 2 m metric, 10 segments (42068)
- ⊕ SoftFinish® dowel racket set with dowels (41289)
1 x PH2 / 2 x 30 / 2 x 40

Striking/ chiselling

- Electrician's hammer with 300 g hammer head, in blister pack 23,9 x 283 (42071)





assorted 80-pcs. in case

9300-702

Order-No.

40523



Fastening / jamming

- Screwdriver SoftFinish® electric Hex nut driver, Tool tested at 10,000 V AC / 5,5 x 125 (00856) / 7 x 125 (00858) / 8 x 125 (00859) / 10 x 125 (00861)
- ⊖ Screwdriver SoftFinish® electric slimFix Slotted, Tool tested at 10,000 V AC / 3,5 x 100 (35446) / 4,0 x 100 (35390) / 5,5 x 125 (35391) / 6,5 x 150 (35392)
- ⊕ Screwdriver SoftFinish® electric slimFix electric PlusMinus/Phillips, Tool tested at 10,000 V AC / SL/PH1 x 80 (35502) / SL/PH2 x 100 (35503)
- ⊕ Screwdriver SoftFinish® electric slimFix PlusMinus/Pozidriv, Tool tested at 10,000 V AC / SL/PZ1 x 80 (36329) / SL/PZ2 x 100 (36330)
- ⊕ Screwdriver SoftFinish® electric slimFix Phillips, Tool tested at 10,000 V AC / PH1 x 80 (35393) / PH2 x 100 (35394)
- ⊕ Screwdriver SoftFinish® electric slimFix Pozidriv, Tool tested at 10,000 V AC / PZ1 x 80 (35395) / PZ2 x 100 (35396)
- ⊖ Screwdriver SoftFinish® Slotted with one-piece hexagonal blade and solid steel cap 12,0 x 200 (03231)
- ⊖ ⊕ ⊖ ⊕ ⊖ Switch cabinet key cross shape (36114)
- ⊖ ⊕ ⊕ Screwdriver with bit magazine LiftUp electric (38611)
1 x 3,0 / 1 x 4,0 / 1 x 5,5 / 1 x PH1 / 1 x PH2 / 1 x SL/PZ2
- L-key set in Compact holder (01418)
1,5 / 2 / 2,5 / 3 / 4 / 5 / 6 / 8 / 10
- Bit set XLSelector Standard 25 mm (29417)
- ⊖ ⊕ ⊕ ⊕ 1 x 4,5 / 1 x 5,5 / 1 x 6,5 / 2 x PH1 / 4 x PH2 / 1 x PH3 / 2 x PZ1 / 5 x PZ2 / 1 x PZ3 / 2 x T10 / 2 x T15 / 2 x T20 / 3 x T25 / 2 x T30 / 1 x T40 / 1 x Bit holder magnetic, 58 mm 1/4"

Trimming / cutting

- ✂ Professional BiCut® high-performance diagonal cutters with DynamicJoint® Switchable, Tool tested at 10,000 V AC / 200mm, 8" (38191)
- ✂ Diagonal cutters Professional electric with DynamicJoint®, Tool tested at 10,000 V AC / 180mm, 7" (26744)
- ✂ Precision mechanic's diagonal cutters Classic with opening spring 125mm, 5" (36189)

Supplying / holding

Water pump pliers Professional electric with push button adjustment, Tool tested at 10,000 V AC / 250mm, 10" (37450)

● Needle nose pliers Professional electric with cutting edge curved shape, approx. 40°, Tool tested at 10,000 V AC / 200mm, 8" (26729)

Combination pliers Professional electric with DynamicJoint® and OptiGrip with extra long cutting edge, Tool tested at 10,000 V AC / 180mm, 7" (26708)

● Needle nose pliers Professional electric with cutting edge straight shape, Tool tested at 10,000 V AC / 200mm, 8" (26727)

Stripping/ insulating / crimping

✂ Installation pliers TriCut Professional electric 170mm, 7" (38552)

Stripping tool automatic up to 6 mm² in blister pack 190mm, 7 ½" (36050)

Stripping tool with self-rotating trailing blade 165mm, 6½" (35969)

■ Crimp tool for wire-end sleeves 220mm, 0,14-16mm² (33844)

Surveying/marketing/measuring/checking

Voltage tester Volt Detector non-contact, single-pole, 230-1,000 VAC (37871)

⊖ Voltage tester SoftFinish® single-pole, 110-250 volts (34745)

Folding ruler Longlife 2 m metric, 10 segments (27057)

Switch cabinet spirit level 20 cm (36859)

INFOBOX: VDE-certified tools



Wiha VDE-tested tools are subject to stringent safety test procedures.

All tools with the special marking have been tested at 10,000 V AC and are therefore approved for use at 1,000 V AC and 1,500 V DC.

The following equipment is required for all work on or around live components and should be appropriate for the specific task

- insulating personal protective equipment
- insulating safety mechanisms
- insulated tools

Before starting work, you must disconnect all active, live components of electrical machines and equipment and ensure that they remain disconnected while you carry out the work.

This is achieved by complying with the five safety rules:

- disconnect
- secure against reconnection
- ensure power is switched off
- earth and short-circuit
- cover or block off adjacent live components

Certified by the VDE Testing and Certification Institute and individually tested according to the international standard IEC 60900.



assorted 29-pcs. in bag

9300-030

Order-No.



37137

1

Fastening / jamming

- ⊖ Screwdriver SoftFinish® electric slimFix Slotted, Tool tested at 10,000 V AC / 3,5 x 100 (35446) / 5,5 x 125 (35391)
- ⊕ Screwdriver SoftFinish® electric slimFix Phillips, Tool tested at 10,000 V AC / PH1 x 80 (35393) / PH2 x 100 (35394)
- ⊕ Screwdriver SoftFinish® electric slimFix Pozidriv, Tool tested at 10,000 V AC / PZ1 x 80 (35395) / PZ2 x 100 (35396)
- ⊖ PicoFinish® fine screwdriver Slotted 1,5 x 40 (42384) / 2,0 x 40 (42388) / 2,5 x 50 (42391) / 3,0 x 50 (42394)
- ⊕ PicoFinish® fine screwdriver Phillips PH00 x 40 (42402) / PH0 x 50 (42401)
- ⊖ ⊕ ⊙ ⊠ ⊚ Switch cabinet key cross shape (36114)
- L-key set in Compact holder (01418)
1,5 / 2 / 2,5 / 3 / 4 / 5 / 6 / 8 / 10

Trimming / cutting

- ✂ Diagonal cutters Professional electric with DynamicJoint®, Tool tested at 10,000 V AC / 160mm, 6 1/2" (26741)
- ✂ Diagonal cutters Electronic wide, pointed head without bevelled edge 130mm, 5 1/2" (26818)

Supplying / holding

- Needle nose pliers Professional electric with cutting edge straight shape, Tool tested at 10,000 V AC / 200mm, 8" (26727)
- Needle nose pliers Electronic narrow, short head straight form 150mm, 6" (26801)

Stripping/ insulating / crimping

Stripping tool with self-rotating trailing blade 165mm, 6 1/2" (35969)

Surveying/markings/measuring/checking

- ⊖ Voltage tester SoftFinish® single-pole, 110-250 volts (34745)

Tool set electrician



assorted 31-pcs. in bag

9300-035

Order-No.



41241

1

Fastening / jamming

⊖ Screwdriver SoftFinish® electric slimFix Slotted, Tool tested at 10,000 V AC / 3,5 x 100 (35446) / 5,5 x 125 (35391)

⊕ Screwdriver SoftFinish® electric slimFix Phillips, Tool tested at 10,000 V AC / PH1 x 80 (35393) / PH2 x 100 (35394)

⊖ ⊕ ⊕ ⊕ Screwdriver with bit magazine magnetic (32901)
1 x 6,5 / 1 x PH1 / 1 x PH2 / 1 x PH3 / 1 x PZ2 / 1 x T15 / 1 x T20 / 1 x T25

⊕ ⊕ ⊕ 1 x PH2 / 1 x PZ1 / 1 x PZ2 / 1 x PZ3 / 1 x T10 / 1 x T15 / 1 x T20 / 1 x T25 / 1 x T30 / 1 x T40 / 1 x Bit holder magnetic, 58 mm 1/4"

Trimming / cutting

⚡ Diagonal cutters Professional electric with DynamicJoint®, Tool tested at 10,000 V AC / 160mm, 6 1/2" (26741)

Supplying / holding

Combination pliers Professional electric with DynamicJoint® and OptiGrip with extra long cutting edge, Tool tested at 10,000 V AC / 180mm, 7" (26708)

Stripping/ insulating / crimping

Stripping tool automatic up to 6 mm² in blister pack 190mm, 7 1/2" (36050)

Surveying/marketing/measuring/checking

⊖ Voltage tester SoftFinish® single-pole, 110-250 volts (34745)

Folding ruler Longlife 2 m metric, 10 segments (27057)

Tool set electrician



assorted 12-pcs. in bag

9300-025

Order-No.



36389

1

Fastening / jamming

⊖ Screwdriver SoftFinish® electric slimFix Slotted, Tool tested at 10,000 V AC / 3,5 x 100 (35446) / 4,5 x 125 (35501) / 5,5 x 125 (35391)

⊕ Screwdriver SoftFinish® electric slimFix Pozidriv, Tool tested at 10,000 V AC / PZ1 x 80 (35395) / PZ2 x 100 (35396)

Trimming / cutting

⚡ Cable cutter Professional electric, Tool tested at 10,000 V AC / 200mm, 8" (34744)

Supplying / holding

● Needle nose pliers Professional electric with cutting edge straight shape, Tool tested at 10,000 V AC / 200mm, 8" (26727)

⚡ Heavy-duty diagonal cutters Professional electric with DynamicJoint® with switchable opening spring 180mm, 7" (41274)

Stripping/ insulating / crimping

Stripping tool automatic up to 6 mm² in blister pack 190mm, 7 1/2" (36050)

Stripping tool with self-rotating trailing blade 165mm, 6 1/2" (35969)

Surveying/marketing/measuring/checking

⊖ Voltage tester SoftFinish® single-pole, 110-250 volts (34745)

Folding ruler Longlife 2 m metric, 10 segments (27057)

Tool set electrician



screwdriver, diagonal cutters, 6-pcs. in bag

9300-018

Order-No.	
33969	1

Fastening / jamming

- ⊖ Screwdriver SoftFinish® electric Slotted, Tool tested at 10,000 V AC / 3,5 x 100 (00822) / 4,5 x 125 (00824) / 5,5 x 125 (00826)
- ⊕ Screwdriver SoftFinish® electric Phillips, Tool tested at 10,000 V AC / PH1 x 80 (00847) / PH2 x 100 (00848)

Trimming / cutting

- ⚡ Diagonal cutters Professional electric with DynamicJoint®, Tool tested at 10,000 V AC / 160mm, 6 1/2" (26741)

Tool set electrician



screwdriver, heavy-duty diagonal cutters, 7-pcs. in bag

9300-031

Order-No.	
38020	1

Fastening / jamming

- ⊖ Screwdriver SoftFinish® electric slimFix Slotted, Tool tested at 10,000 V AC / 3,5 x 100 (35446) / 4,0 x 100 (35390) / 5,5 x 125 (35391)
- ⊕ Screwdriver SoftFinish® electric slimFix Phillips, Tool tested at 10,000 V AC / PH2 x 100 (35394)
- ⊕ Screwdriver SoftFinish® electric slimFix Pozidriv, Tool tested at 10,000 V AC / PZ2 x 100 (35396)
- ⊕ Screwdriver SoftFinish® electric slimFix PlusMinus/Pozidriv, Tool tested at 10,000 V AC / SL/PZ2 x 100 (36330)

Supplying / holding

- ⚡ Heavy-duty diagonal cutters Professional electric with DynamicJoint® with switchable opening spring 160mm, 6,5" (40921)

Tool set electrician



screwdriver, needle nose pliers, diagonal cutters, 5-pcs. in bag

Z 99 0 002 06

Order-No.  1
26755

Fastening / jamming

⊖ Screwdriver SoftFinish® electric Slotted, Tool tested at 10,000 V AC / 3,5 x 100 (00822) / 5,5 x 125 (00826)

⊕ Screwdriver SoftFinish® electric Phillips, Tool tested at 10,000 V AC / PH2 x 100 (00848)

Trimming / cutting

⚡ Diagonal cutters Professional electric with DynamicJoint®, Tool tested at 10,000 V AC / 160mm, 6 1/2" (26741)

Supplying / holding

⦿ Needle nose pliers Professional electric with cutting edge straight shape, Tool tested at 10,000 V AC / 200mm, 8" (26727)

Bit set for mounting



19-pcs. in bag

79187 T04

Order-No.  1
41223

- ⊕ 1 x T15 / 1 x T20 / 1 x T25 / 1 x T30 / 1 x T40
- ⊕ 1 x PH0 / 1 x PH1 / 1 x PH2
- ⊕ 1 x SL/PZ1 / 1 x SL/PZ2
- ⊖ 1 x 3,5 / 1 x 4,0 / 1 x 5,5
- ⊖ 1 x 4,0 / 1 x 5,0 / 1 x 6,0
- ⊖ 1 x Bit holder magnetic, 74 mm 1/4"
- ⊖ 1 x Screwdriver handle SoftFinish®-telescopic for SYSTEM 6 interchangeable blade
- ⊖ 1 x Bit holder SYSTEM 6 clamping with ball

INFOBOX:
DynamicJoint®



Wiha DynamicJoint® – A new dimension in strength and durability

- Innovative: Optimised joint construction.
- Effective: Minimal power loss means less force needed for cutting.
- Permanent: Optimal performance even after thousands of cuts.

Tool set electrician



assorted slotted, Phillips, 10-pcs. in belt pouch

9300-012-01

Order-No.



40948

1

Fastening / jamming

- ⊖ Screwdriver SoftFinish® electric slimFix Slotted, Tool tested at 10,000 V AC / 3,5 x 100 (35446) / 4,0 x 100 (35390) / 5,5 x 125 (35391)
- ⊕ Screwdriver SoftFinish® electric slimFix Phillips, Tool tested at 10,000 V AC / PH1 x 80 (35393) / PH2 x 100 (35394)

Stripping/ insulating / crimping

- ⊠ Stripping pliers Professional electric 160mm, 6 1/2" (26847)
- Stripping tool with self-rotating trailing blade 165mm, 6 1/2" (35969)

Supplying / holding

- Needle nose pliers Professional electric with cutting edge straight shape, Tool tested at 10,000 V AC / 200mm, 8" (26727)

Surveying/marketing/measuring/checking

- ⊖ Voltage tester SoftFinish® single-pole, 110-250 volts (34745)
- Measuring tape 5 m (33251)

Tool set electrician



assorted slotted, Pozidriv, 10-pcs. in belt pouch

9300-013-02

Order-No.



40282

1

Fastening / jamming

- ⊖ Screwdriver SoftFinish® electric slimFix Slotted, Tool tested at 10,000 V AC / 3,5 x 100 (35446) / 4,0 x 100 (35390) / 5,5 x 125 (35391)
- ⊕ Screwdriver SoftFinish® electric slimFix Pozidriv, Tool tested at 10,000 V AC / PZ1 x 80 (35395) / PZ2 x 100 (35396)

Stripping/ insulating / crimping

- ⊠ Stripping pliers Professional electric 160mm, 6 1/2" (26847)
- Stripping tool with self-rotating trailing blade 165mm, 6 1/2" (35969)

Supplying / holding

- Needle nose pliers Professional electric with cutting edge straight shape, Tool tested at 10,000 V AC / 200mm, 8" (26727)

Surveying/marketing/measuring/checking

- ⊖ Voltage tester SoftFinish® single-pole, 110-250 volts (34745)
- Measuring tape 5 m (33251)

INFOBOX:
slimTECHNOLOGY

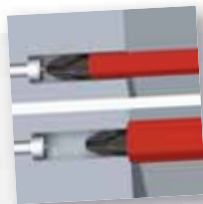

Wiha SoftFinish® electric slimFix

- Unlimited access.
- Blades up to 33 % narrower due to integrated insulation.
- Tool for spring clips (wedge-profiled output geometry).

Ratchet wrench set insulated 1/2"



20-pcs. in case

7208N K2001

Order-No.	
43024	1
T-handle insulated for nut driver (43063)	
Ratchet wrench insulated for nut drivers Switchable 1/2" x 250 mm (43053)	
<input type="radio"/>	Insulated extension 1/2" square adapter for nut driver inserts, insulated 1/2" x 250 mm (43056) / 1/2" x 125 mm (43055)
<input type="radio"/>	Insulated nut driver insert 1/2" hexagon head 10 / 11 / 12 / 13 / 14 / 17 / 19 / 22 / 24 / 27 / 32
<input checked="" type="radio"/>	Insulated nut driver insert 1/2" internal hexagon 4 x 120 mm / 5 x 120 mm / 6 x 120 mm / 8 x 120 mm / 10 x 120 mm

Manufactured according to EN/IEC 60900.

Ratchet wrench set insulated 3/8"



20-pcs. in case

7207N K2001

Order-No.	
43023	1
T-handle insulated for nut driver (43062)	
Ratchet wrench insulated for nut drivers Switchable 3/8" x 200 mm (43052)	
<input type="radio"/>	Insulated extension 3/8" square adapter for nut driver inserts, insulated 3/8" x 125 mm (43057) / 3/8" x 250 mm (43058)
<input type="radio"/>	Insulated nut driver insert 3/8" internal hexagon 8 / 10 / 11 / 12 / 13 / 14 / 16 / 17 / 18 / 19 / 21 / 22
<input checked="" type="radio"/>	Insulated nut driver insert 3/8" internal hexagon 4 x 75 / 5 x 75 mm / 6 x 75 mm / 8 x 75 mm

Manufactured according to EN/IEC 60900.

Single open-end spanner set, insulated 6-32 mm



20-pcs. in case

5590N T20

Order-No.	
43022	1
○	Single, insulated open-end spanner 6 / 7 / 8 / 9 / 10 / 11 / 12 / 13 / 14 / 15 / 16 / 17 / 18 / 19 / 22 / 24 / 27 / 30 / 32
○	Adjustable spanner electric Adjustable between 0-30 mm 0 - 30 x 250 mm (43061)

Manufactured according to EN/IEC 60900.

Single, insulated open-end spanner



Order-No.	○		5590N
43026	6	1	
43027	7	1	
43028	8	1	
43029	9	1	
43030	10	1	
43031	11	1	
43032	12	1	
43033	13	1	
43034	14	1	
43035	15	1	
43036	16	1	
43037	17	1	
43038	18	1	
43039	19	1	
43040	22	1	
43041	24	1	
43042	27	1	
43043	30	1	
43044	32	1	

Manufactured according to EN/IEC 60900.

Adjustable spanner electric



Order-No.	○	mm		246199
43061	0 - 30	250	1	

Manufactured according to EN/IEC 60900.

T-handle insulated for nut driver



24618

Order-No.	□	mm	📦
43062	3/8"	200	10
43063	1/2"	200	10

Manufactured according to EN/IEC 60900.

Insulated nut driver insert



○ 1/2" hexagon head

7208N

Order-No.	○	📦
43077	10	1
43078	11	1
43079	12	1
43080	13	1
43081	14	1
43082	17	1
43083	19	1
43084	22	1
43085	24	1
43086	27	1
43087	32	1

Manufactured according to EN/IEC 60900.

Insulated nut driver insert



7207N

○ 3/8" internal hexagon

Order-No.	○	📦
43065	8	1
43066	10	1
43067	11	1
43068	12	1
43069	13	1
43070	14	1
43071	16	1
43072	17	1
43073	18	1
43074	19	1
43075	21	1
43076	22	1

Manufactured according to EN/IEC 60900.

Insulated nut driver insert



○ 1/4" hexagon head

246

Order-No.	○	📦
43088	4	1
43089	5	1
43090	5,5	1
43091	6	1
43092	7	1
43093	8	1
43094	9	1
43095	10	1
43096	11	1
43097	12	1
43098	13	1
43099	14	1

Manufactured according to EN/IEC 60900.

Insulated extension



○ 1/2" square adapter for nut driver inserts, insulated

7208N

Order-No.	■ t	← mm	
43055	1/2"	125	1
43056	1/2"	250	1

Manufactured according to EN/IEC 60900.

○ 3/8" square adapter for nut driver inserts, insulated

7207N

Order-No.	■ t	← mm	
43057	3/8"	125	1
43058	3/8"	250	1

Manufactured according to EN/IEC 60900.

Insulated nut driver insert



● 1/2" internal hexagon

7208N

Order-No.	●	← mm	
43100	4	120	1
43101	5	120	1
43102	6	120	1
43103	8	120	1
43104	10	120	1

Manufactured according to EN/IEC 60900.

Insulated nut driver insert



● 3/8" internal hexagon

7207N

Order-No.	●	← mm	
43105	4	75	1
43106	5	75	1
43107	6	75	1
43108	8	75	1

Manufactured according to EN/IEC 60900.

Ratchet wrench insulated for nut drivers



Switchable

24619

Order-No.	■ t	← mm	
43052	3/8"	200	1
43053	1/2"	250	1

Manufactured according to EN/IEC 60900.



assorted 31-pcs. in bag

9300-026

Order-No.	
36390	1
⊖	Screwdriver SoftFinish® Slotted with round blade and lasered mm scale 4,0 x 100 (36085) / 5,5 x 125 (35397)
⊕	Screwdriver SoftFinish® Phillips with round blade and lasered mm scale PH1 x 80 (36072) / PH2 x 100 (35398)
○	Screwdriver with T-handle and two bit holders ComfortGrip magnetic 1/4" 1/4 x 150 (26179)
	High-leverage combination pliers Professional with DynamicJoint® and OptiGrip with extra long cutting edge 200mm, 8" (26713)
⚡	Heavy-duty diagonal cutters Professional with DynamicJoint® with switchable opening spring 180mm, 7" (41273)
	Water pump pliers Classic with push button 250mm, 10" (26765)
	Folding ruler Longlife 2 m metric, 10 segments (27057)
⊕ ⊕ ⊕	Bit set FlipSelector Standard 25 mm (39040) 2 x PH2 / 1 x PZ1 / 2 x PZ2 / 1 x PZ3 / 1 x T10 / 1 x T15 / 1 x T20 / 1 x T25 / 1 x T30 / 1 x T40 / 1 x Bit holder magnetic, 58 mm 1/4"
●	L-key set in ErgoStar holder (37351) 1,5 / 2 / 2,5 / 3 / 4 / 5 / 6 / 8 / 10



assorted 30-pcs. in bag

9300-024

Order-No.	
36388	1
⊖	Screwdriver SoftFinish® Slotted with round blade for low-lying screws 3,0 x 100 (00687) / 5,5 x 125 (00698)
⊕	Screwdriver SoftFinish® Phillips with round blade PH1 x 80 (00756) / PH2 x 100 (00759)
○	Screwdriver with T-handle and bit holder magnetic 1/4" 1/4 x 150 (01481)
⚡	Diagonal cutters Classic 160mm, 6 1/2" (26739)
	Water pump pliers Classic box type 250mm, 10" (26761)
	Folding ruler Longlife 2 m metric, 10 segments (27057)
⊕ ⊕ ⊕	Bit set FlipSelector Standard 25 mm (39040) 2 x PH2 / 1 x PZ1 / 2 x PZ2 / 1 x PZ3 / 1 x T10 / 1 x T15 / 1 x T20 / 1 x T25 / 1 x T30 / 1 x T40 / 1 x Bit holder magnetic, 58 mm 1/4"
●	L-key set in Compact holder (01222) 1,5 / 2 / 2,5 / 3 / 4 / 5 / 6 / 8 / 10

INFOBOX:
OptiGrip



Wiha OptiGrip – optimal grip due to newly designed gripping surfaces

- A firm hold: The „triple-point support“ protects the workpiece from twisting or slipping.
- Highly effective: Optimum grip even with large jaw opening – and at the same time significantly less force needed.
- A wide selection: Now in standard Wiha combination pliers and high leverage combination pliers.



screwdriver, combination pliers, 6-pcs. in bag

9300-019

Order-No.	
33970	1
⊖	Screwdriver SoftFinish® Slotted with round blade for low-lying screws 3,5 x 100 (00691) / 4,5 x 125 (00697)
⊖	Screwdriver SoftFinish® Slotted with round blade 6,5 x 150 (00703)
⊕	Screwdriver SoftFinish® Phillips with round blade PH1 x 80 (00756) / PH2 x 100 (00759)
	Combination pliers Professional with DynamicJoint® and OptiGrip with extra long cutting edge 180mm, 7" (26707)



screwdriver, diagonal cutters, 6-pcs. in bag

9300-020

Order-No.	
33971	1
⊖	Screwdriver SoftFinish® Slotted with round blade for low-lying screws 3,5 x 100 (00691) / 4,5 x 125 (00697)
⊖	Screwdriver SoftFinish® Slotted with round blade 6,5 x 150 (00703)
⊕	Screwdriver SoftFinish® Phillips with round blade PH1 x 80 (00756) / PH2 x 100 (00759)
⚡	Diagonal cutters Professional with DynamicJoint® 160mm, 6 1/2" (26740)

Tool set mechanic



screwdriver, diagonal cutters, combination pliers, 5-pcs. in bag

Z 99 0 006 02

Order-No.	
30824	1
⊖	Screwdriver SoftFinish® Slotted with round blade for low-lying screws 3,5 x 100 (00691) / 5,5 x 125 (00698)
⊕	Screwdriver SoftFinish® Phillips with round blade PH2 x 100 (00759)
	Combination pliers Industrial with DynamicJoint® and OptiGrip with extra long cutting edge 180mm, 7" (30826)
	Diagonal cutters Industrial with DynamicJoint® With Wiha DynamicJoint®. 160mm, 6 1/2" (30827)

Tool set operator kit ESD



5-pcs. in bag

9300-015

Order-No.	
33504	1
⊖	Screwdriver Precision ESD Slotted 2,5 x 50 (07636)
⊕	Screwdriver Precision ESD Phillips PH0 x 50 (07641)
	Universal tweezers Professional ESD Type AA 130mm, AA (32318)
	SMD belt shears (31989)
	Dust and dirt brush x (39141)

Tool set ESD



Pliers, screwdriver, tweezers, 9-pcs. in bag

9300-016

Order-No.	
33505	1
⊖	Screwdriver Precision ESD Slotted 2,0 x 40 (07635) / 2,5 x 50 (07636)
⊕	Screwdriver Precision ESD Phillips PH00 x 40 (07640) / PH0 x 50 (07641)
⊛	Screwdriver Precision ESD TORX® T5 x 40 (07659) / T6 x 40 (07660)
●	Needle nose pliers Professional ESD straight 120mm, 4 3/4" (26799)
	Diagonal cutters Professional ESD wide, pointed head without bevelled edge 115mm, 4 1/2" (26821)
	Universal tweezers Professional ESD Type AA 130mm, AA (32318)

INFOBOX:
**Electrostatic
conductive ESD
tools**



Sensitive, electronic components can be damaged even at a very low voltage.

- Dissipative tools by Wiha discharge the electrostatic energy in a controlled, safe manner.
- ESD tools meet the ESD Standard IEC 61340-5-1.
- ESD tool handles have a surface resistance of 10⁶ -10⁹ Ohm.



Electro **Safety for professionals.**

With the speedE® e-screwdriver, Wiha is revolutionising the screwdriver market. Whether handling delicate fastenings, long screws or very many screws, professionals have no trouble working with the e-screwdriver. The material protection function in particular makes the speedE® unique: At 0.4 Nm the electrical assistance stops automatically and allows the user to finish tightening the screw carefully by hand. In combination with the VDE certified slimBits the speedE® offers electricians full protection during their daily work.

The swivelling Wiha flashlight features an integrated laser, UV light and LED light with two lighting levels.

With Torque QuickCheck, Wiha is bringing the first portable quick tester for regular checks on torque tools onto the market, thus guaranteeing safe and precise work.

Application **Electro**

Fastening

**E-screwdriver, set 2,
speedE®**
Page 126



**Surveying /
marking**

**Flashlight with LED,
laser and UV light**
Page 128



Testing

**Torque QuickCheck
torque testing device**
Page 129



E-screwdriver, set 1, speedE®



Slotted, Phillips, PlusMinus/Pozidriv, 10 pcs in L
Boxx Mini with slimBits, batteries and EU charger

590 T101

Order-No.	SB	Box
41911	x	1
○	E-screwdriver handle speedE®	
⊖	Bit slimBit electric Slotted, Tool tested at 10,000 V AC / 3,5 x 75 (41159) / 5,5 x 75 (34581)	
⊕	Bit slimBit electric Phillips, Tool tested at 10,000 V AC / PH1 x 75 (34583) / PH2 x 75 (34584)	
⊗	Bit slimBit electric PlusMinus/Pozidriv, Tool tested at 10,000 V AC / SL/PZ1 x 75 (34589) / SL/PZ2 x 75 (34590)	
	Battery set, 18500 Li-ion 2 units in box (41914)	
	Charger for 18500 Li-ion batteries with USB and Europlug (41915)	

E-screwdriver, set 2, speedE®



Mixed 13 pcs in L Boxx Mini with slimBits,
easyTorque adapter, batteries and EU charger

590 T102

Order-No.	SB	Box
41912	x	1
○	E-screwdriver handle speedE®	
⊖	Bit slimBit electric Slotted, Tool tested at 10,000 V AC / 3,5 x 75 (41159) / 5,5 x 75 (34581)	
⊕	Bit slimBit electric Phillips, Tool tested at 10,000 V AC / PH1 x 75 (34583) / PH2 x 75 (34584)	
⊗	Bit slimBit electric Pozidriv, Tool tested at 10,000 V AC / PZ1 x 75 (34585) / PZ2 x 75 (34586)	
⊗	Bit slimBit electric PlusMinus/Pozidriv, Tool tested at 10,000 V AC / SL/PZ1 x 75 (34589) / SL/PZ2 x 75 (34590)	
	easyTorque electric torque adapter for slimBits and slimVario® holder in blister 2,8 ±10 % (41344)	
	Battery set, 18500 Li-ion 2 units in box (41914)	
	Charger for 18500 Li-ion batteries with USB and Europlug (41915)	

E-screwdriver, set 3, speedE®



Mixed 25 pcs in L Boxx Mini with slimBits, easyTorque adapters, batteries and EU charger

590 T103

Order-No. SB 1
41913 x

- E-screwdriver handle speedE®
- ⊖ Bit slimBit electric Slotted, Tool tested at 10,000 V AC / 3,5 x 75 (41159) / 5,5 x 75 (34581)
- ⊕ Bit slimBit electric Phillips, Tool tested at 10,000 V AC / PH1 x 75 (34583) / PH2 x 75 (34584)
- ⊕ Bit slimBit electric Pozidriv, Tool tested at 10,000 V AC / PZ1 x 75 (34585) / PZ2 x 75 (34586)
- ⊕ Bit slimBit electric PlusMinus/Pozidriv, Tool tested at 10,000 V AC / SL/PZ1 x 75 (34589) / SL/PZ2 x 75 (34590)
- ⊗ Bit slimBit electric TORX®, Tool tested at 10,000 V AC / T10 x 75 (35507) / T15 x 75 (35508) / T20 x 75 (35509) / T25 x 75 (36071)
- Bit slimBit electric Hex, Tool tested at 10,000 V AC / 3 x 75 (37147) / 4 x 75 (37225) / 5 x 75 (37226) / 6 x 75 (37227)
- easyTorque electric torque adapter for slimBits and slimVario® holder in blister 4,0 ± 10 % (41345) / 0,8 Nm ± 10 % (41341) / 2,0 Nm ± 10 % (41342) / 2,5 Nm ± 10 % (41343) / 2,8 Nm ± 10 % (41344)
- Battery set, 18500 Li-ion 2 units in box (41914)
- Charger for 18500 Li-ion batteries with USB and Europlug (41915)

Battery set, 18500 Li-ion



2 units in box

599001

Order-No. 6
41914

Charger for 18500 Li-ion batteries



with USB and Europlug

599002

Order-No. 1
41915

INFOBOX:
Wiha speedE®







E-screwdriver speedE®

- Power-assisted screw-driving halves working time.
- Thanks to the integrated material protection function, the electric assistance stops automatically at 0.4 Nm.
- Final screw tightening can then be carried out by hand.
- Recommended by doctors and therapists.
- slimBits tested at 10,000 V AC and approved for 1,000 V AC.



in blister pack, including 3 AAA batteries

SB 246 70

Order-No.	LED		UV			
41286	100 / 310 lm	Class 2	390 - 400 nm	3 x AAA batteries	x	5

INFOBOX:
Flashlight with LED,
laser and UV light



- Universal work tool with integrated laser, UV light and LED light.
- Optimum positioning and variable light direction thanks to the magnetic base and swivel head.
- The installation position can be projected directly from the middle of a table when fitting lights to the ceiling.
- The integrated UV light is ideal for finding misplaced coloured fluorescent Wiha tools and for technical inspections.



with adapter blades and batteries in box

2909101

Order-No.	Nm	7.2%	SB
42086	2,8	2	x



1

INFOBOX: Torque QuickCheck



Wiha Torque QuickCheck

- The Wiha torque screwdriver can quickly and easily test torque screwdrivers to check the precision of the configured torque value before each use.
- Checking tools regularly ensures reliable, precise work.
- The device offers user-friendly operation, clear test readings and easy to understand LED traffic light signals.
- Thanks to a compact, handy shape, it is the ideal companion when out on jobs.
- Suitable for all Torque Vario®-S and iTorque® torque screwdrivers whose torque range included 2.8 Nm.



Screwdrivers

We have the know-how at the tip of our fingers.

Unlike many standard tools available on the market, Wiha screwdrivers are optimally designed for users' requirements. Thanks to Wiha's screwdriver handle size concept, four handle sizes and lengths, optimally adapted to their specific fastening or work task, ensure health-friendly work practices. With SoftFinish, Wiha became the world's first and only hand tool manufacturer to have products honoured with the renowned AGR quality seal - a seal of approval accepted by medical professionals and officially recommended by doctors and therapists. Wiha screwdrivers featuring SoftFinish are available for dry applications, damp and oily applications and as VDE-certified, insulated screwdrivers for use when working on live parts..

Wiha is the world's first hand tool manufacturer to receive AGR (Association for healthy backs) certification for its Inomic pliers and ergonomic screwdriver handle size concept, a seal of approval accepted by medical professionals and officially recommended by doctors and physiotherapists.

Application

Screwdrivers

For applications
in electrics



**Screwdriver and bit set
slimVario® screwdriver
assorted 18-pcs. in bag**
Page 132



**Screwdriver set
SoftFinish® electric
slimFix
assorted 12-pcs.**
Page 133

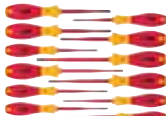

**Screwdriver set
SoftFinish® electric
slimFix**
Page 134



**Screwdriver with bit
holder set SoftFinish®
electric slimVario®
Stubby, 4-pcs.**
Page 136



slimBit electric bit set
Page 136



Bit slimBit electric
Page 137



**Screwdriver SoftFinish®
electric slimFix**
Page 138



**Screwdriver SoftFinish®
electric**
Page 139



**Fine screwdriver
PicoFinish electric**
Page 140



**SoftFinish® voltage
tester**
Page 141



For applications
in mechanics



**Screwdriver set
SoftFinish®
assorted 12-pcs.**
Page 142



**Screwdriver set
SoftFinish®**
Page 142



**Screwdriver set SoftFinish®
Solid steel cap and
hexagon head**
Page 144



**Fine screwdriver set
PicoFinish**
Page 145

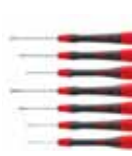

**Screwdriver SoftFinish®
With round blade**
Page 146



**Screwdriver SoftFinish®
Solid steel cap and
hexagon head**
Page 150



**Fine screwdriver
PicoFinish**
Page 152



**Screwdriver SoftFinish®
Phillips with short round
blade, Stubby**
Page 151



**Screwdriver MicroFinish®
Solid steel cap and
hexagon head**
Page 155



Screwdriver MicroFinish®
Page 155



**Screwdriver MicroFinish®
Solid steel cap and
hexagon head**
Page 156



**Screw extractor set
Hexagon with spiral drill
bit 8-pcs.**
Page 156



For applications
in electronics



**Screwdriver set
SoftFinish® ESD**
Page 157



**Screwdriver set
Precision ESD**
Page 157



**Screwdriver SoftFinish®
ESD**
Page 158



**Screwdriver SoftFinish®
ESD
Phillips Stubby**
Page 158



Screwdriver and bit set slimVario® screwdriver



assorted 18-pcs. in bag

2831 T18

Order-No.  1
41231

- 1 x Screwdriver with bit holder SoftFinish® electric slimVario Stubby for slimBits, Tool tested at 10,000 V AC
 - 1 x Screwdriver with bit holder SoftFinish® electric slimVario For slimBits, Tool tested at 10,000 V AC
 - 1 x 2,5 / 1 x 3,5 / 1 x 5,5
 - 1 x PH1 / 1 x PH2
 - 1 x PZ1 / 1 x PZ2
 - 1 x SL/PZ1 / 1 x SL/PZ2
 - 1 x T9 / 1 x T10 / 1 x T15 / 1 x T20
 - 1 x 3 / 1 x 4 / 1 x 5
- Manufactured acc. to IEC 60900.

Screwdriver and bit set slimVario® screwdriver



Slotted, Phillips, Pozidriv, 9-pcs. in bag

2831 T9 01

Order-No.  1
41232

- 1 x Screwdriver with bit holder SoftFinish® electric slimVario Stubby for slimBits, Tool tested at 10,000 V AC
 - 1 x Screwdriver with bit holder SoftFinish® electric slimVario For slimBits, Tool tested at 10,000 V AC
 - 1 x 2,5 / 1 x 3,5 / 1 x 5,5
 - 1 x PH1 / 1 x PH2
 - 1 x PZ1 / 1 x PZ2
- Manufactured acc. to IEC 60900.

Slotted, Pozidriv, PlusMinus/Pozidriv, 9-pcs. in bag

2831 T9 02

Order-No.  1
41233

- 1 x Screwdriver with bit holder SoftFinish® electric slimVario Stubby for slimBits, Tool tested at 10,000 V AC
 - 1 x Screwdriver with bit holder SoftFinish® electric slimVario For slimBits, Tool tested at 10,000 V AC
 - 1 x 2,5 / 1 x 3,5 / 1 x 5,5
 - 1 x PZ1 / 1 x PZ2
 - 1 x SL/PZ1 / 1 x SL/PZ2
- Manufactured acc. to IEC 60900.

INFOBOX:
slimTECHNOLOGY

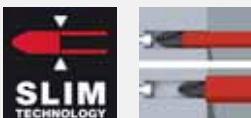

Wiha SoftFinish® electric slimFix

- Unlimited access.
- Blades up to 33 % narrower due to integrated insulation.
- Tool for spring clips (wedge-profiled output geometry).

Screwdriver set SoftFinish® electric slimFix



assorted 12-pcs.

3201 K12

Order-No.	
41003	1
⊖	3,5 x 100 / 4,0 x 100 / 5,5 x 125 / 6,5 x 150
⊕	PH1 x 80 / PH2 x 100
⊕	PZ1 x 80 / PZ2 x 100
⊕	SL/PZ2 x 100
⊕	T15 x 100 / T20 x 100 / T25 x 125

INFOBOX: Handle size concept



Wiha SoftFinish® handle sizes

- Every Wiha handle optimally balances guidance, speed and torque for the respective fastening task.
- Quick-turning - Motor skills are consistently taken into consideration.
- Maximum power transmission: comfortable and loss-free transmission of physical strength, even during intensive fastening.
- The power-turning and quick-turning zones (length) vary significantly over the four handle sizes in various forms.
- The Wiha SoftFinish screwdrivers enable work that is kind on the hands and muscles and is therefore recommended by doctors and therapists from the AGR.

INFOBOX: VDE-certified tools



Wiha VDE-tested tools are subject to stringent safety test procedures.

All tools with the special marking have been tested at 10,000 V AC and are therefore approved for use at 1,000 V AC and 1,500 V DC.

The following equipment is required for all work on or around live components and should be appropriate for the specific task

- insulating personal protective equipment
- insulating safety mechanisms
- insulated tools

Before starting work, you must disconnect all active, live components of electrical machines and equipment and ensure that they remain disconnected while you carry out the work.

This is achieved by complying with the five safety rules:

- disconnect
- secure against reconnection
- ensure power is switched off
- earth and short-circuit
- cover or block off adjacent live components

Certified by the VDE Testing and Certification Institute and individually tested according to the international standard IEC 60900.

Screwdriver set SoftFinish® electric slimFix



Slotted, Phillips 6-pcs.

3201 K6

Order-No.  1

35389

⊖ 3,5 x 100 / 4,0 x 100 / 5,5 x 125 / 6,5 x 150

⊕ PH1 x 80 / PH2 x 100

Manufactured acc. to IEC 60900.

Slotted, Phillips, PlusMinus/Pozidriv 6-pcs.

3201 K601

Order-No.  1

38362

⊖ 3,5 x 100 / 4,0 x 100 / 5,5 x 125

⊕ PH1 x 80 / PH2 x 100

⊕ SL/PZ2 x 100

Manufactured acc. to IEC 60900.

Slotted, Pozidriv 6-pcs.

3201 ZK6

Order-No.  1

36455

⊖ 3,5 x 100 / 4,0 x 100 / 5,5 x 125 / 6,5 x 150

⊕ PZ1 x 80 / PZ2 x 100

Manufactured acc. to IEC 60900.

TORX® Tamper Resistant (with hole) 6-pcs.

3251 TR K6

Order-No.  1

41245

⊕ T10H x 100 / T15H x 100 / T20H x 100 / T25H x 125 / T30H x 125 / T40H x 150

Manufactured acc. to IEC 60900.

TORX® 6-pcs.

3251 K6

Order-No.  1

36558

⊕ T8 x 60 / T9 x 60

⊕ T10 x 100 / T15 x 100 / T20 x 100 / T25 x 125

• no slim version

Manufactured acc. to IEC 60900.

Screwdriver set SoftFinish® electric slimFix



Slotted, Phillips, 2-pcs. in blister pack

SB 3201 S201

Order-No.  1

36331

⊖ 3,5 x 100

⊕ PH2 x 100

Manufactured acc. to IEC 60900.

Slotted, Pozidriv, 2-pcs. in blister pack

SB 3201 S202

Order-No.  1

36332

⊖ 3,5 x 100

⊕ PZ2 x 100

Manufactured acc. to IEC 60900.

Slotted, PlusMinus/Pozidriv, 2-pcs. in blister pack

SB 3201 S204

Order-No.  1

36333

⊖ 3,5 x 100

⊕ SL/PZ2 x 100

Manufactured acc. to IEC 60900.

INFOBOX:
Combination profiles

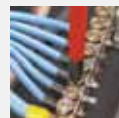

PlusMinus.

- The special PlusMinus/Pozidriv profile is ideal for PlusMinus terminal screws.
- The combination profile reduces slipping out and guarantees a higher torque transmission.



Screwdriver set SoftFinish® electric



Slotted, Phillips 7-pcs.

320N K7

Order-No.	
00834	1
⊖	2,5 x 75 / 4,0 x 100 / 5,5 x 125 / 6,5 x 150
⊕	PH1 x 80 / PH2 x 100
⊖	Voltage tester SoftFinish® single-pole, 110-250 volts

Manufactured acc. to IEC 60900.

Slotted, Phillips 6-pcs.

320N K6

Order-No.	
00833	10
⊖	3,0 x 100 / 4,0 x 100 / 5,5 x 125 / 6,5 x 150
⊕	PH1 x 80 / PH2 x 100

Manufactured acc. to IEC 60900.

Slotted, Pozidriv 6-pcs.

320N ZK6 S0

Order-No.	
25477	1
⊖	2,5 x 75 / 3,5 x 100 / 4,5 x 125 / 5,5 x 125
⊕	PZ1 x 80 / PZ2 x 100

Manufactured acc. to IEC 60900.

Screwdriver set SoftFinish® electric



PlusMinus/Phillips in blister pack 2-pcs.

SB 327 S2

Order-No.	
32281	1
⊕	SL/PH1 x 80 / SL/PH2 x 100

Manufactured acc. to IEC 60900.

PlusMinus/Pozidriv, 2-pcs. in blister pack

SB 328 S2

Order-No.	
32282	1
⊕	SL/PZ1 x 80 / SL/PZ2 x 100

DIN ISO 2380. Manufactured acc. to IEC 60900.

Screwdriver set SoftFinish® electric



Hexagon nut driver 5-pcs.

322 K5

Order-No.	
29466	1
⊙	5,5 x 125 / 7 x 125 / 8 x 125 / 10 x 125 / 13 x 125

Manufactured acc. to IEC 60900.

Screwdriver with bit holder set SoftFinish® electric slimVario®



Stubby, 4-pcs.

SB 2831 0101

Order-No.



41230

1

○ Screwdriver with bit holder SoftFinish® electric slimVario Stubby for slimBits Tool tested at 10,000 V AC

⊖ 3,5 x 75

⊕ PH2 x 75

⊗ SL/PZ2 x 75

Manufactured acc. to IEC 60900.

Fine screwdriver set PicoFinish® electric



Slotted, Phillips, 6-pcs.

227P

Order-No.



42989

1

⊖ 2,0 x 50 / 2,5 x 65 / 3 x 65 / 1,5 x 50

⊕ PH00 x 50 / PH0 x 65

slimBit electric bit set



2831-B604

TORX®, 6-pcs. in box

Order-No.



42210

6

⊗ 1 x T8 / 1 x T9 / 1 x T10 / 1 x T15 / 1 x T20 / 1 x T25

Manufactured acc. to IEC 60900.

Slotted, Pozidriv, 6-pcs. in box

2831-B605

Order-No.



42211

6

⊖ 1 x 2,5 / 1 x 3,5 / 1 x 5,5 / 1 x 6,5

⊗ 1 x PZ1 / 1 x PZ2

Manufactured acc. to IEC 60900.

Slotted, Phillips, 6-pcs. in box

2831-B606

Order-No.



42212

6

⊖ 1 x 6,5 / 1 x 2,5 / 1 x 5,5 / 1 x 3,5

⊕ 1 x PH1 / 1 x PH2

Manufactured acc. to IEC 60900.

Slotted, PlusMinus/Pozidriv, 6-pcs. in box

2831-B607

Order-No.



42213

6

⊖ 1 x 2,5 / 1 x 3,5 / 1 x 5,5 / 1 x 6,5

⊗ 1 x SL/PZ1 / 1 x SL/PZ2

Manufactured acc. to IEC 60900.

Hex, 6-pcs. in box

2831-B608

Order-No.



42214

6

⊗ 1 x 2 / 1 x 2,5 / 1 x 3 / 1 x 4 / 1 x 5 / 1 x 6

Manufactured acc. to IEC 60900.

**INFOBOX:
PicoFinish electric**



Wiha PicoFinish electric: The VDE-GS tested precision screwdriver.

- The smooth-running turn-cap enables fast turning.
- Imprint with the screw symbol and sizes eases recognition.



Slotted

2831-10

Order-No.	⊖	mm	⊖	⊖	max. Nm	
34578	2,5•	75	0,4	6,0	0,4	5
34579	3,0•	75	0,5	6,0	0,6	5
41159	3,5	75	0,6	6,0	2,5	5
34580	4,0	75	0,8	6,0	2,5	5
34581	5,5	75	1,0	6,0	5,5	5
34582	6,5	75	1,2	6,0	5,5	5

• no slim version
Manufactured acc. to IEC 60900.

Phillips

2831-11

Order-No.	⊕	mm	⊖	max. Nm	
34583	PH1	75	6,0	3,8	5
34584	PH2	75	6,0	5,5	5

Manufactured acc. to IEC 60900.

Pozidriv

2831-12

Order-No.	⊕	mm	⊖	max. Nm	
34585	PZ1	75	6,0	3,8	5
34586	PZ2	75	6,0	5,5	5

Manufactured acc. to IEC 60900.

PlusMinus/Phillips

2831-13

Order-No.	⊕	mm	⊖	max. Nm	
34587	SL/PH1	75	6,0	3,8	5
34588	SL/PH2	75	6,0	5,5	5

Manufactured acc. to IEC 60900.

PlusMinus/Pozidriv

2831-14

Order-No.	⊕	mm	⊖	max. Nm	
34589	SL/PZ1	75	6,0	3,8	5
34590	SL/PZ2	75	6,0	5,5	5

Manufactured acc. to IEC 60900.

TORX®

2831-15

Order-No.	⊕	mm	⊖	max. Nm	
35506	T8•	75	6,0	1,3	5
41160	T9•	75	6,0	1,3	5
35507	T10•	75	6,0	3,8	5
35508	T15	75	6,0	5,0	5
35509	T20	75	6,0	5,5	5
36071	T25	75	6,0	5,5	5

• no slim version
Manufactured acc. to IEC 60900.

Hex

2831-18

Order-No.	⊖	mm	⊖	max. Nm	
37222	1,5•	75	6,0	0,9	5
37223	2•	75	6,0	1,8	5
37224	2,5	75	6,0	3,8	5
37147	3	75	6,0	5,5	5
37225	4	75	6,0	5,5	5
37226	5	75	6,0	5,5	5
37227	6	75	6,0	5,5	5

• no slim version
Manufactured acc. to IEC 60900.

Square

2831-17

Order-No.	⊖	mm	⊖	max. Nm		
35510	#1	2,3	75	6,0	5,5	5
35511	#2	2,8	75	6,0	5,5	5

Manufactured acc. to IEC 60900.

Screwdriver with bit holder SoftFinish® electric slimVario



For slimBits

283100

Order-No.	⊖	mm	mm	mm		
34577	6	30	50	160	13	5

Manufactured acc. to IEC 60900.



⊖ Slotted

3201

Order-No.	⊖	↔	⊖	↔ mm	↔	
35446	3,5	100	0,6	204	23	10
35390	4,0	100	0,8	211	30	10
35501	4,5	125	1,0	236	30	10
35391	5,5	125	1,0	243	36	10
35392	6,5	150	1,2	268	36	10

DIN ISO 2380. Manufactured acc. to IEC 60900.

⊕ Phillips

3211

Order-No.	⊕	↔	↔ mm	↔	SB	
35393	PH1	80	191	30		10
35394	PH2	100	218	36		10

DIN ISO 8764-PH. Manufactured acc. to IEC 60900.

⊕ Pozidriv

3241

Order-No.	⊕	↔	↔ mm	↔	SB	
35395	PZ1	80	191	30		10
35396	PZ2	100	218	36		10

DIN ISO 8764-PZ. Manufactured acc. to IEC 60900.

⊕ PlusMinus/Phillips

3271

Order-No.	⊕	↔	↔ mm	↔	
35502	SL/PH1	80	191	30	10
35503	SL/PH2	100	218	36	10

Manufactured acc. to IEC 60900.

⊕ PlusMinus/Pozidriv

3281

Order-No.	⊕	↔	↔ mm	↔	SB	
36329	SL/PZ1	80	191	30		10
36330	SL/PZ2	100	218	36		10

Manufactured acc. to IEC 60900.

⊕ TORX® Tamper Resistant (with hole)

3251 TR

Order-No.	⊕	↔	↔ mm	↔	
41141	T10H	100	204	23	10
41142	T15H	100	211	30	10
41143	T20H	100	211	30	10
41144	T25H	125	243	36	10
41145	T27H	125	243	36	10
41146	T30H	125	243	36	10
41147	T40H	150	268	36	10

Manufactured acc. to IEC 60900.

⊕ TORX®

3251

Order-No.	⊕	↔	↔ mm	↔	
36536	T10	100	204	23	10
36537	T15	100	211	30	10
36538	T20	100	211	30	10
36539	T25	125	243	36	10
36540	T27	125	243	36	10
36541	T30	125	243	36	10
36542	T40	150	268	36	10

DIN ISO 8764-PH. Manufactured acc. to IEC 60900.

⊕ Square

3581

Order-No.	⊕	⊕	↔	↔ mm	↔	
35504	#1	2,3	100	211	30	10
35505	#2	2,8	125	243	36	10

Manufactured acc. to IEC 60900.



⊖ Slotted

320N

Order-No.	⊖	↔	⊖	↔ mm	↔	
00819	2,0	60	0,4	164	23	10
00820	2,5	75	0,4	179	23	10
00821	3,0	100	0,5	204	23	10
00822	3,5	100	0,6	204	23	10
00823	4,0	100	0,8	211	30	10
00824	4,5•	125	1,0	236	30	10
00825	4,5•	175	1,0	286	30	5
31863	4,5	200	1,0	311	30	5
00826	5,5	125	1,0	243	36	10
00827	5,5•	175	1,0	293	36	5
00828	6,0•	150	1,2	268	36	10
00829	6,5	150	1,2	268	36	10
00830	8,0	175	1,2	299	41	10
00831	8,0	175	1,6	299	41	10
00832	10,0•	200	1,6	324	41	5

• Additional dimension. Non-DIN size.
Manufactured acc. to IEC 60900.

⊕ Phillips

321N

Order-No.	⊕	↔	↔ mm	↔	
00846	PH0	60	164	23	10
00847	PH1	80	191	30	10
00848	PH2	100	218	36	10
00849	PH3	150	268	41	10
00850	PH4	200	318	41	5

Manufactured acc. to IEC 60900.

⊕ Pozidriv

324

Order-No.	⊕	↔	↔ mm	↔	
00877	PZ0	60	164	23	10
00878	PZ1	80	191	30	10
00879	PZ2	100	218	36	10
00880	PZ3	150	324	41	5

Manufactured acc. to IEC 60900.

⊕ PlusMinus/Phillips

327

Order-No.	⊕	↔	↔ mm	↔	
30716	SL/PH1	80	191	30	10
30715	SL/PH2	100	218	36	10

Manufactured acc. to IEC 60900.

⊕ PlusMinus/Pozidriv

328

Order-No.	⊕	↔	↔ mm	↔	
30700	SL/PZ1	80	191	30	10
30701	SL/PZ2	100	218	36	10

Manufactured acc. to IEC 60900.

⊕ TORX®

325

Order-No.	⊕	↔	↔ mm	↔	
03760	T5	60	164	23	10
03761	T6	60	164	23	10
03762	T7	60	164	23	10
00881	T8	60	164	23	10
00882	T9•	60	164	23	10

Manufactured acc. to IEC 60900.

● Hex

323N

Order-No.	●	↔	↔ mm	↔	
30361	2,5	75	179	23	10
30362	3,0	75	179	23	10
30363	4,0	75	186	30	10
30364	5,0	75	186	30	10
30365	6,0	100	218	36	10
30366	8,0	100	218	36	10

Manufactured acc. to IEC 60900.

■ Square

358N

Order-No.	■	↔	↔ mm	↔		
32396	#1	2,3	100	211	30	10
32397	#2	2,8	150	268	36	10

Manufactured acc. to IEC 60900.

Screwdriver SoftFinish® electric



Fine screwdriver PicoFinish electric



Hex nut driver

322

Order-No.	⊙	↔	mm	↔	↔	📦
00853	4	125	236	30	10,2	10
00855	5	125	236	30	11,2	10
00856	5,5	125	236	30	11,2	10
00857	6	125	236	30	12,2	10
00858	7	125	243	36	14,5	10
00859	8	125	243	36	15,2	10
00860	9	125	243	36	16,0	10
00861	10	125	243	36	17,2	10
00862	11	125	243	41	19,2	10
00863	12	125	243	41	20,2	10
00864	13	125	243	41	22,2	10
00865	14	125	243	41	23,2	10
00866	15	125	243	41	25,2	10
00867	16	125	243	41	25,2	10
00868	17	125	243	41	27,2	10

Manufactured acc. to IEC 60900.

Slotted

2270P

Order-No.	⊖	↔	⊙	mm	↔	📦
42374	1,5	50	2,0	152	18	10
42375	2,0	50	2,0	152	18	10
42376	2,5	65	2,5	167	18	10
42377	3	65	3	167	18	10
42471	3,5	65	3,5	167	18	10

Phillips

2271P

Order-No.	⊕	↔	⊙	mm	↔	📦
42379	PH00	50	2	152	18	10
42378	PH0	65	3	167	18	10
42380	PH1	65	4	167	18	10

SoftFinish® voltage tester



Order-No.	⊖	↔	⊖	mm	mm	📦
34745	3,0	60	0,5	140	19	10

Tested according to DIN 57680-6, GS, CE compliant.

in blister pack

SB 255-11

Order-No.	⊖	↔	⊖	mm	mm	📦
35378	3,0	60	0,5	140	19	5

Tested according to DIN 57680-6, GS, CE compliant.

Voltage tester 150-250 volts



Order-No.	⊖	↔	mm	mm	📦
00456	3,0	60	160	17	10

Slotted black, with push-on clip in blister pack

SB 255-7

Order-No.	⊖	↔	mm	mm	📦
31771	3,0	60	160	17	1

Voltage tester Volt Detector non-contact, single-pole, 230-1,000 VAC



255-12

Order-No.	●	mm	📦
37871	4,2	149	10

IEC 61010-1

in blister pack

SB 255-12

Order-No.	●	mm	📦
37872	4,2	149	5

IEC 61010-1

Voltage tester 220-250 volts



Order-No.	⊖	↔	mm	mm	📦
05271	3,0	60	140	15	10

Slotted transparent, with push-on clip in blister pack

SB 255-3

Order-No.	⊖	↔	mm	mm	📦
32201	3,0	60	140	15	5

Screwdriver set SoftFinish®



assorted 12-pcs.

302 HK12

Order-No.	
41002	1
⊖	4,0 x 100 / 3,5 x 100 / 6,5 x 150
⊕	PH1 x 80 / PH2 x 100 / PH3 x 150
⊗	PZ1 x 80 / PZ2 x 100
⊛	T15 x 80 / T20 x 100 / T25 x 100 / T30 x 115

INFOBOX:
Wiha SoftFinish®
screwdriver



The convenient expert for dry applications.

- The SoftFinish handle provides optimal grip for dry applications in trade and industry.
- The position of the soft and hard zones on the handle also supports the perfect grip for quick and powerful turning.

Screwdriver set SoftFinish®



Slotted, Phillips 6-pcs.

302 HK6 SO

Order-No.	
07152	1
⊖	3,5 x 100 / 4,5 x 125 / 5,5 x 150 / 6,5 x 150
⊕	PH1 x 80 / PH2 x 100

Phillips, Pozidriv 6-pcs.

302 HK 601

Order-No.	
26113	1
⊖	4,0 x 100 / 5,5 x 125 / 6,5 x 150
⊕	PH1 x 80 / PH2 x 100
⊗	PZ2 x 100

Slotted, Pozidriv 6-pcs.

302 ZK6 SO

Order-No.	
07153	1
⊖	3,5 x 100 / 4,5 x 125 / 5,5 x 150 / 6,5 x 150
⊗	PZ1 x 80 / PZ2 x 100

TORX® ball end 6-pcs.

362BE K6

Order-No.	
32249	1
⊛	T9 x 60 / T10 x 60 / T15 x 80 / T20 x 80 / T25 x 100 / T30 x 115

TORX® MagicSpring® 6-pcs.

362R K6 SO

Order-No.	
27746	1
⊛	T10 x 80 / T15 x 80 / T20 x 100 / T25 x 100 / T30 x 115 / T40 x 130

TORX® 6-pcs.

362 K6 SO

Order-No.	
07155	1
⊛	T10 x 80 / T15 x 80 / T20 x 100 / T25 x 100 / T30 x 115 / T40 x 130

TORX® 7-pcs.

362 K7

Order-No.	
01299	1
⊛	T8 x 60 / T9 x 60 / T10 x 80 / T15 x 80 / T20 x 100 / T25 x 100 / T30 x 115

TORX® Tamper Resistant (with hole) 6-pcs.

362TR K6

Order-No.	
24506	1
⊛	T10H x 80 / T15H x 80 / T20H x 100 / T25H x 100 / T30H x 115 / T40H x 130

Screwdriver set SoftFinish®



Hexagon nut driver 5-pcs.

341 K5

Order-No.



01034

1

○ 5,5 x 125 / 7 x 125 / 8 x 125 / 10 x 125 / 13 x 125

Screwdriver set SoftFinish®



Slotted, Phillips with hexagon head 6-pcs.

308 HK6

Order-No.



21248

1

⊖ 3,5 x 75 / 4,5 x 90 / 5,5 x 100 / 7,0 x 125

⊕ PH1 x 80 / PH2 x 100

Slotted, Pozidriv with hexagon head, 6-pcs.

308 ZK6

Order-No.



21249

1

⊖ 3,5 x 75 / 4,5 x 90 / 5,5 x 100 / 7,0 x 125

⊕ PZ1 x 80 / PZ2 x 100

INFOBOX:
MagicRing®

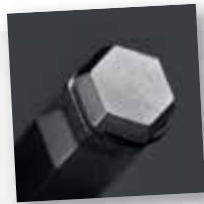
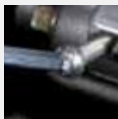

Wiha MagicRing®

- Spring steel ring reliably holds hex screws in place
- An innovation, which will benefit each user.

INFOBOX:
MagicSpring®



Wiha TORX® MagicSpring®

- TORX® and TORX PLUS® screws are held securely in place.
- An innovation, which will benefit each user.

INFOBOX:
TORX® ball end

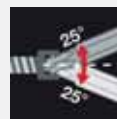

Wiha TORX® ball end

- With optimised TORX® ball end geometry
- Increased strength thanks to the special cold forming on a system developed by Wiha especially for this purpose.
- Allows fastening and unfastening at angles up to 25°.
- Simple insertion of the tool/bit and fastening/unfastening, especially in hard-to-reach positions.
- Broad product range: As an L-key, as a bit and as a SoftFinish® screwdriver.

Screwdriver set SoftFinish®



Slotted, Phillips hexagonal blade and solid steel cap, 6-pcs.

530 HK6

Order-No.	
21250	1
⊖	3,5 x 75 / 4,5 x 90 / 5,5 x 100 / 6,5 x 125
⊕	PH1 x 80 / PH2 x 100

Slotted, Pozidriv hexagonal blade and solid steel cap, 6-pcs.

530 ZK6

Order-No.	
21251	1
⊖	3,5 x 75 / 4,5 x 90 / 5,5 x 100 / 6,5 x 125
⊕	PZ1 x 80 / PZ2 x 100

Screwdriver set SoftFinish®



Slotted, Phillips with lasered mm scale in blister pack, 2-pcs.

SB 3021 S2

Order-No.	
36205	1
⊖	5,5 x 125
⊕	PH2 x 100
DIN ISO 2380.	

INFOBOX:

Solid steel cap and hexagon head



- The solid steel cap at the end of the screwdriver handle enables targeted hammering, e.g. to loosen jammed screws.
- The direct connection of the solid steel cap to the blade means that the impact energy is transmitted without any loss.
- Blade includes a hexagon bolster for using a set of spanners for additional torque.



Slotted, Phillips 7-pcs.

260P

Order-No.	
42991	1
	1,5 x 40 / 2,0 x 40 / 2,5 x 50 / 3,0 x 50
	PH00 x 40 / PH0 x 50 / PH1 x 60

Slotted, Phillips, 6 pcs. with holder

260P

Order-No.	
42990	1
	1,5 x 40 / 2,0 x 40 / 2,5 x 50 / 3,0 x 50
	PH00 x 40 / PH0 x 50

TORX® MagicSpring®, 6 pcs. with holder

267PR

Order-No.	
42998	1
	T6 x 40 / T7 x 40 / T8 x 40 / T9 x 50 / T10 x 50 / T15 x 60

TORX®, 6 pcs. with holder

267P

Order-No.	
42996	1
	T7 x 40 / T8 x 40 / T9 x 50 / T10 x 50 / T15 x 60 / T20 x 60

TORX®, 6 pcs. with holder

267P

Order-No.	
42997	1
	T4 x 40 / T5 x 40 / T6 x 40 / T7 x 40 / T8 x 40 / T9 x 50

Hexagonal ball end, 6 pcs. with holder

264P

Order-No.	
42993	1
	0,9 (0,035") x 40
	1,3 (0,05") x 40 / 1,5 x 50 / 2,0 x 50 / 2,5 x 60 / 3,0 x 60

Hex, 6 pcs. with holder

263P

Order-No.	
42992	1
	0,9 (0,035") x 40 / 1,3 (0,05") x 40 / 1,5 x 50 / 2,0 (5/64") x 50 / 2,5 x 60 / 3,0 x 60

Hexagon nut driver 6-pcs. with holder

265P

Order-No.	
42994	1
	2,5 x 60 / 3,0 x 60 / 3,5 x 60 / 4,0 x 60 / 5 x 60 / 5,5 x 60

**INFOBOX:
PicoFinish**



Wiha PicoFinish precision screwdriver

- The comfortable precision screwdriver for fine and delicate fastenings.
- The smooth-running turn-cap enables fast turning.
- Imprint with the screw symbol and sizes eases recognition.

Screwdriver SoftFinish®



With round blade for low-lying screws



With round blade



Slotted with round blade for low-lying screws

302

Order-No.	⊖	↔	⊖	●	mm	↔	📦
00684	2,0•	65	0,4	2,0	169	23	10
00685	2,5	75	0,4	2,5	179	23	10
00686	3,0•	80	0,5	3,0	184	23	10
00687	3,0	100	0,5	3,0	204	23	10
00689	3,0•	150	0,5	3,0	254	23	10
00690	3,0•	200	0,5	3,0	304	23	10
32383	3,0	300	0,5	3,0	404	23	5
00691	3,5	100	0,6	3,5	204	23	10
26931	3,5•	200	0,6	3,5	304	23	10
00692	4,0	100	0,8	4,0	211	30	10
00694	4,0•	150	0,8	4,0	261	30	10
00695	4,0•	200	0,8	4,0	311	30	10
00696	4,0•	300	0,8	4,0	411	30	10
27753	4,5•	80	0,8	4,5	191	30	10
00697	4,5•	125	0,8	4,5	236	30	10
00698	5,5	125	1,0	5,5	236	30	10
00700	5,5	150	1,0	5,5	261	30	10
00701	5,5•	200	1,0	5,5	311	30	10
00702	5,5•	300	1,0	5,5	411	30	5
32384	6,0•	300	1,0	6,0	418	36	5

• Additional dimension. Non-DIN size.

Slotted with round blade

302

Order-No.	⊖	↔	⊖	●	mm	↔	📦
27754	6,0	100	1,0	5,5	218	36	10
27755	6,0	150	1,0	5,5	268	36	10
00704	6,5	100	1,2	6,0	218	36	10
00703	6,5	150	1,2	6,0	268	36	10
00706	6,5•	200	1,2	6,0	318	36	10
00708	8,0	150	1,2	7,0	274	41	10
00707	8,0	175	1,2	7,0	299	41	10
00709	8,0	175	1,6	7,0	299	41	5
32399	8,0	300	1,2	7,0	424	41	5
00711	10,0	200	1,6	8,0	324	41	10
32400	10,0	300	1,6	8,0	424	41	5
00712	12,0	250	2,0	8,0	374	41	10
00713	14,0•	250	2,5	11,0	374	41	10

• Additional dimension. Non-DIN size.
DIN ISO 2380.

Phillips with round blade

311

Order-No.	⊕	↔	●	mm	↔	📦
00754	PH0	60	3,0	164	23	10
27756	PH0	100	3,0	204	23	10
00756	PH1	80	4,5	191	30	10
27757	PH1	100	4,5	211	30	10
00757	PH1•	200	4,5	311	30	10
03738	PH1•	300	4,5	411	30	5
00759	PH2	100	6,0	218	36	10
27758	PH2	150	6,0	268	36	10
00760	PH2•	200	6,0	318	36	10
03739	PH2•	300	6,0	418	36	5
00762	PH3	150	8,0	274	41	10
00763	PH4•	200	10,0	324	41	10

• Additional dimension. Non-DIN size.
DIN ISO 8764-PH.

Pozidriv with round blade

313

Order-No.	⊕	↔	●	mm	↔	📦
00768	PZ0	60	3,0	164	23	10
00770	PZ1	80	4,5	191	30	10
26454	PZ1	300	4,5	411	30	5
00772	PZ2	100	6,0	218	36	10
26455	PZ2	300	6,0	418	36	5
00774	PZ3	150	8,0	274	41	10

TORX® ball end with hexagonal blade

362BE

Order-No.	⊕	↔	●	mm	↔	📦	
32250	T9	60	7/64	2,8	164	23	10
32251	T10	60	1/8	3,2	184	23	10
32252	T15	80	9/64	3,6	191	30	10
32253	T20	80	5/32	4,0	211	30	10
32254	T25	100	3/16	4,8	218	36	10
32255	T27	115	7/32	5,6	233	36	10
32256	T30	115	1/4	6,4	233	36	10

TORX® MagicSpring® with round blade

362R

Order-No.	⊕	↔	●	mm	↔	📦
27736	T6	60	3,5	164	23	10
27737	T7	60	3,5	164	23	10
27738	T8	60	3,5	164	23	10
27739	T9	60	4,0	171	30	10
27740	T10	80	4,0	191	30	10
27741	T15	80	4,0	191	30	10
27742	T20	100	4,0	218	36	10
27743	T25	100	4,5	218	36	10
27811	T27	115	5,5	233	36	10
27744	T30	115	6,0	233	36	10
27745	T40	130	7,0	254	41	10

TORX® with round blade

362

Order-No.						
			mm			
26259	T3	60	2,5	164	23	10
26260	T4	60	2,5	164	23	10
01285	T5	60	2,5	164	23	10
01286	T6	60	3,5	164	23	10
01287	T7	60	3,5	164	23	10
01288	T8	60	3,5	164	23	10
01289	T9	60	4,0	171	30	10
01290	T10	80	4,0	191	30	10
01291	T15	80	4,0	191	30	10
01292	T20	100	4,0	218	36	10
01293	T25	100	4,5	218	36	10
01294	T27	115	5,5	233	36	10
01295	T30	115	6,0	233	36	10
01296	T40	130	7,0	254	41	10
01297	T45	130	8,0	254	41	5

TORX® Tamper Resistant (with hole) with round blade

362TR

Order-No.						
			mm			
03106	T7H	60	3,5	164	23	10
03107	T8H	60	3,5	164	23	10
03108	T9H	60	4,0	171	30	10
26456	T9H	300	4,0	411	30	5
01300	T10H	80	4,0	191	30	10
26457	T10H	300	4,0	411	30	5
01301	T15H	80	4,0	191	30	10
26458	T15H	300	5,0	411	30	5
01302	T20H	100	4,0	211	30	10
28005	T20H	300	5,0	411	30	5
01303	T25H	100	4,5	211	30	10
01304	T27H	115	5,5	233	36	10
01305	T30H	115	6,0	233	36	10
01306	T40H	130	7,0	254	41	10

TORX PLUS® MagicSpring® with round blade

362RIP

Order-No.						
			mm			
28760	6IP	60	3,5	164	23	10
28761	7IP	60	3,5	164	23	10
28762	8IP	60	3,5	164	23	10
28763	9IP	60	4,0	171	30	10
28764	10IP	80	4,0	191	30	10
28765	15IP	80	4,0	191	30	10
28766	20IP	100	4,0	218	36	10
28767	25IP	100	4,5	218	36	10
28769	30IP	115	6,0	233	36	10
28770	40IP	130	7,0	254	41	10

TORX PLUS® with round blade

362IP

Order-No.						
			mm			
26091	6IP	60	3,5	164	23	10
26093	7IP	60	3,5	164	23	10
26095	8IP	60	3,5	164	23	10
26097	9IP	60	4,0	171	30	10
26099	10IP	80	4,0	191	30	10
26101	15IP	80	4,0	191	30	10
26103	20IP	100	4,0	218	36	10
26105	25IP	100	4,5	218	36	10
26107	27IP	115	5,5	233	36	10
26109	30IP	115	6,0	233	36	10
26111	40IP	130	7,0	254	41	10

MagicRing® hexagonal ball end with hexagonal blade

367R

Order-No.					
			mm		
26077	3	100	204	23	10
26079	4	100	211	30	10
26081	5	100	211	30	10
26083	6	125	243	36	10
26085	8	150	268	36	10
26087	10	150	271	41	5

Hexagonal ball end with hexagonal blade

367

Order-No.					
			mm		
26303	1,5	75	179	23	10
26304	2	100	204	23	10
26305	2,5	100	204	23	10
26328	3	100	204	23	10
26329	4	100	211	30	10
26330	5	100	211	30	10
26331	6	125	243	36	10
26332	8	150	268	36	10
26333	10	150	271	41	5
26307	12	150	271	41	5

Hexagon with hexagonal blade

356

Order-No.					
			mm		
32264	1,5	60	164	23	10
32265	2	60	164	23	10
26190	2,5	75	179	23	10
26191	3	75	179	23	10
26192	4	75	186	30	10
26193	5	75	186	30	10
26194	6	100	218	36	10
26195	8	100	218	36	10

Screwdriver SoftFinish®



● Hexagon angled

357

Order-No.	●	←	↖	↗	mm	
26230	3	35	20	139	23	10
26231	4	40	25	151	30	10
26232	5	45	28	156	30	10
26233	6	50	32	168	36	10
26234	8	60	36	178	36	10
26235	10	75	40	199	41	10

Screwdriver SoftFinish®



○ Hexagon nut driver, inch design with round blade and hexagon head

347 Zoll

Order-No.	○	←	○	mm	mm		
02836	3/16	125	10	231	30	4,76	10
02837	1/4	125	10	238	36	6,35	10
02838	5/16	125	10	238	36	7,94	10
02839	3/8	125	10	238	36	9,53	10
02840	7/16	125	13	246	41	11,11	10
02841	1/2	125	13	246	41	12,70	10

Screwdriver SoftFinish®



○ Hexagon nut driver with round blade

341

Order-No.	○	←	mm	←		
01018	4	125	236	30	6,9	10
01020	5	125	236	30	7,9	10
01021	5,5	125	236	30	7,9	10
01022	6	125	236	30	8,9	10
01023	7	125	243	36	10,9	10
01024	8	125	243	36	11,9	10
01025	9	125	243	36	12,9	10
01026	10	125	243	36	14,4	10
01027	11	125	249	41	15,9	10
01028	12	125	249	41	16,9	10
01029	13	125	249	41	18,4	10
01030	14	125	249	41	19,4	10
01031	15	125	249	41	21,9	10
01032	16	125	249	41	21,9	10
01033	17	125	249	41	23,4	10

○ Hexagon nut driver with short round blade

343

Order-No.	○	←	mm	←		
01076	5,5	65	176	30	8	10
01077	6	65	176	30	9	10
01078	7	65	183	36	11	10
01079	8	65	183	36	12	10
01081	10	65	183	36	14	10

Screwdriver SoftFinish®



○ Hexagon nut driver with flexible shaft

372

Order-No.	○	↔	mm	↔	↔	📦
01435	5	150	261	30	8	10
01436	5,5	150	261	30	8	10
01437	6	150	261	30	9	10
01438	7	150	268	36	11	10
01439	8	150	268	36	12	10
01440	10	175	293	41	14	10
01443	13	175	293	41	19	10

Screwdriver SoftFinish®



○ Hexagon nut driver with round blade and hexagon head

347

Order-No.	○	↔	○	mm	↔	↔	📦
01092	7	125	10	238	36	11,0	10
01093	8	125	10	238	36	12,0	10
01094	9	125	10	238	36	13,0	10
01095	10	125	10	238	36	14,5	10
01096	11	125	13	246	41	16,0	10
01097	12	125	13	246	41	17,0	10
01098	13	125	13	246	41	19,0	10

Screwdriver SoftFinish®



▲ Triangular socket wrench

344

Order-No.	▲	↔	▲	mm	↔	↔	📦
26212	M4	125	6,8	236	30	11	10
26213	M5	125	8,3	236	30	13	10
26216	M6	125	10,05	236	30	16	10
26214	M8	125	12,05	243	36	18	10
26217	M10	125	15,05	243	36	22	10
26218	M12	125	16,55	249	41	24	10

DIN 22416.

Screwdriver SoftFinish®



⊖ Slotted with one-piece hexagonal blade and solid steel cap

530

Order-No.	⊖	↔	⊖	⬠	⊖	mm	📦
03223	3,5	75	0,6	4.0	-	186	10
03224	4,5•	90	0,8	4.0	-	201	10
03225	5,5	100	1,0	5.0	8	213	10
03226	6,5	125	1,2	6.0	10	238	10
03228	8,0	150	1,2	8.0	13	271	5
03230	10,0	175	1,6	8.0	13	296	5
03231	12,0	200	2,0	10.0	16	321	5
03232	14,0•	250	2,5	10.0	16	371	5

• Additional dimension. Non-DIN size.

⊕ Phillips with one-piece hexagonal blade and solid steel cap

531

Order-No.	⊕	↔	⬠	⊖	mm	↔	📦
03237	PH1	80	5,0	8	186	30	10
03238	PH2	100	6,0	10	213	36	10
03239	PH3	150	8,0	13	268	41	10

⊕ Pozidriv with one-piece hexagonal blade and solid steel cap

532

Order-No.	⊕	↔	⬠	⊖	mm	↔	📦
03245	PZ1	80	5,0	8	186	30	10
03246	PZ2	100	6,0	10	213	36	10
03247	PZ3	150	8,0	13	268	41	10

Screwdriver SoftFinish®



⊖ Slotted with round blade and lasered mm scale

3021

Order-No.	⊖	↔	⊖	●	mm	↔	📦
36085	4,0	100	0,8	4.0	211	30	10
35397	5,5	125	1,0	5.5	236	30	10

DIN ISO 2380.

⊕ Phillips with round blade and lasered mm scale

3111

Order-No.	⊕	↔	●	mm	↔	Scale	📦
36072	PH1	80	4,5	191	30	20-70	10
35398	PH2	100	6,0	218	36	20-90	10

DIN ISO 8764-PH.

⊕ Pozidriv with round blade and lasered mm scale

3131

Order-No.	⊕	↔	●	mm	↔	Scale	📦
36073	PZ1	80	4,5	191	30	20-70	10
35399	PZ2	100	6,0	218	36	20-90	10

DIN ISO 8764-PZ.

Screwdriver SoftFinish®



⊖ Slotted with fixing function

398

Order-No.	⊖	↔	⊖	mm	↔	📦
32867	2,5	75	0,4	186	30	5
32868	3,0	100	0,5	211	30	5
32869	4,0	125	0,8	243	36	5
32870	5,0	150	1,0	268	36	5
32871	6,0	175	1,2	293	36	5

⊕ Phillips with fixing function

397

Order-No.	⊕	↔	mm	↔	📦
32406	PH0	100	211	30	5
32404	PH1	125	236	36	5
32405	PH2	175	286	36	5

Screwdriver SoftFinish®



⊖ Slotted with short round blade

302

Order-No.	⊖	↔	⊖	●	mm	↔	📦
26964	4,0	25	0,8	4,0	81	34	10
26965	5,5	25	1,0	5,5	81	34	10
26966	6,5	25	1,2	6,5	81	34	10
26967	8,0	25	1,2	8,0	81	34	10

⊕ Phillips with short round blade, Stubby

311

Order-No.	⊕	↔	●	mm	↔	📦
26968	PH1	25	4,5	81	34	10
26969	PH2	25	6,0	81	34	10
26970	PH3	25	8,0	81	34	10

⊕ Pozidriv with short round blade, Stubby

313

Order-No.	⊕	↔	●	mm	↔	📦
26971	PZ1	25	4,5	81	34	10
26972	PZ2	25	6,0	81	34	10
26973	PZ3	25	8,0	81	34	10

Screwdriver SoftFinish®



⊖ Slotted with hexagonal blade and hexagon head

308

Order-No.	⊖	↔	⊖	●	○	mm	📦
00731	3,5	75	0,6	4,0	-	186	10
00732	4,5•	90	0,8	4,0	-	201	10
00733	5,5	100	1,0	5,0	8	213	10
00734	6,5	125	1,2	6,0	10	238	10
00735	7,0•	125	1,1	6,0	10	238	10
00736	8,0	150	1,2	8,0	13	268	10
00737	9,0•	150	1,4	8,0	13	268	10
00738	10,0	175	1,6	8,0	13	293	10
00739	12,0	200	2,0	10,0	16	318	10
00740	14,0•	250	2,5	10,0	16	368	10

• Additional dimension. Non-DIN size.

⊕ Phillips with hexagonal blade and hexagon head

312

Order-No.	⊕	↔	●	○	mm	↔	📦
00764	PH1	80	5,0	8	186	30	10
00765	PH2	100	6,0	10	213	36	10
00766	PH3	150	8,0	13	268	41	10
00767	PH4	200	10,0	16	318	41	10

⊕ Pozidriv with hexagonal blade and hexagon head

314

Order-No.	⊕	↔	●	○	mm	↔	📦
00776	PZ1	80	5,0	8	186	30	10
00777	PZ2	100	6,0	10	213	36	10
00778	PZ3	150	8,0	13	268	41	10
00779	PZ4	200	10,0	16	318	41	10

Square reamer



■ with square tip and plastic handle

300-2

Order-No.	■	↔	mm	↔	📦
00679	6,0	100	185	34	10

Awl plastic handle



● with round tip and plastic handle

301-2

Order-No.	●	↔	mm	↔	📦
00683	6,0	100	185	34	10



Slotted

260P

Order-No.	⊖	↔	●	mm	+	
42381	0,8	40	2	134	9	10
42382	1,0	40	2	134	9	10
42383	1,2	40	2	134	9	10
42384	1,5	40	2	134	9	10
42385	1,5	60	2	154	9	10
42386	1,8	40	2	134	9	10
42387	1,8	60	2	154	9	10
42388	2,0	40	2	140	18	10
42389	2,0	60	2	160	18	10
42390	2,0	100	2	200	18	10
42391	2,5	50	2,5	150	18	10
42392	2,5	75	2,5	175	18	10
42393	2,5	100	2,5	200	18	10
42394	3,0	50	3	150	18	10
42395	3,0	100	3	200	18	10
42397	3,5	60	3,5	160	18	10
42398	4,0	60	4	160	18	10
42399	4,0	100	4	200	18	10

Phillips

261P

Order-No.	⊕	↔	●	mm	+	
42403	PH000	40	2	134	9	10
42402	PH00	40	2	134	9	10
42413	PH00	60	2	154	9	10
42401	PH0	50	3	150	18	10
42414	PH0	75	3	175	18	10
42415	PH1	60	4	160	18	10
42416	PH1	80	4	180	18	10

Pozidriv

262P

Order-No.	⊕	↔	●	mm	+	
42418	PZ0	50	3	150	18	10
42419	PZ1	60	4	160	18	10

TORX® MagicSpring®

267PR

Order-No.	⊕	↔	●	mm	+	
42501	T6	40	2,5	140	18	10
42502	T7	40	2,5	140	18	10
42503	T8	40	2,5	140	18	10
42504	T9	50	3	150	18	10
42505	T10	50	3	150	18	10
42506	T15	60	3,5	150	18	10

TORX®

267P

Order-No.	⊕	↔	●	mm	+	
42474	T1	40	2,5	134	9	10
42475	T2	40	2,5	134	9	10
42476	T3	40	2,5	134	9	10
42477	T4	40	2,5	134	9	10
42478	T5	40	2,5	134	9	10
42479	T6	40	2,5	140	18	10
42480	T7	40	2,5	140	18	10
42481	T8	40	2,5	140	18	10
42482	T9	50	3	150	18	10
42483	T10	50	3	150	18	10
42484	T15	60	3,5	160	18	10
42485	T20	60	4	160	18	10

TORX PLUS®

267PIP

Order-No.	⊕	↔	●	mm	+	
42486	4IP	40	2,5	134	9	10
42487	5IP	40	2,5	134	9	10
42488	6IP	40	2,5	140	18	10
42489	7IP	40	2,5	140	18	10
42490	8IP	40	2,5	140	18	10
42491	9IP	50	3	150	18	10
42492	10IP	50	3	150	18	10
42493	15IP	60	3,5	160	18	10
42494	20IP	60	4	160	18	10

Pentalobe

266P

Order-No.	⊕	↔	●	mm	+	
42464	PL1	40	2,5	134	9	10
42465	PL2	40	2,5	134	9	10
42466	PL3	40	2,5	134	9	10
42467	PL4	40	2,5	134	9	10
42468	PL5	40	2,5	134	9	10
42469	PL6	40	2,5	140	18	10

Y-type

266PY

Order-No.	⊕	↔	●	mm	+	
42470	0	40	2	134	9	10

● **Ball end hex**

264P

Order-No.	●	↔	mm	↔	📦
42431	1,3 (0,05")	40	134	9	10
42432	1,5	50	150	18	10
42433	2,0	50	150	18	10
42434	2,5	60	160	18	10
42435	3,0	60	160	18	10

● **Hex**

263P

Order-No.	●	↔	mm	↔	📦
42421	0,9 (0,035")	40	134	9	1
42422	1,3 (0,05")	40	134	9	1
42423	1,5	50	144	9	1
42424	2,0 (5/64")	50	150	18	1
42425	2,5	60	160	18	1
42426	3	60	160	18	1

● **Hexagonal ball end, inch design**

264P Zoll

Order-No.	●	↔	mm	↔	📦
42436	1/16"	50	150	18	10
42440	5/64"	50	150	18	10
42438	3/32"	50	150	18	10
42441	7/64"	60	160	18	10
42437	1/8"	60	160	18	10
42442	9/64"	60	160	18	10
42439	5/32"	60	160	18	10

PicoFinish® fine screwdriver



○ **Hex nut driver**

265P

Order-No.	○	↔	mm	↔	📦
42443	1,5	60	160	18	10
42444	1,8	60	160	18	10
42445	2	60	160	18	10
42446	2,5	60	160	18	10
42447	3,0	60	160	18	10
42449	3,5	60	160	18	10
42450	4,0	60	160	18	10
42451	4,5	60	160	18	10
42452	5	60	160	18	10
42453	5,5	60	160	18	10
42454	6	60	160	18	10
42455	7	60	160	18	10

○ **Hexagon nut driver, inch design**

265P Zoll

Order-No.	○	↔	mm	↔	📦
42459	3/32"	60	160	18	10
42462	7/64"	60	160	18	10
42457	1/8"	60	160	18	10
42463	9/64"	60	160	18	10
42460	5/32"	60	160	18	10
42458	3/16"	60	160	18	10
42461	7/32	60	160	18	10
42456	1/4"	60	160	18	10

Lifter PicoFinish



268P

Order-No.	↔	●	mm	↔	📦
42507	50	3,5	150	18	10

INFOBOX:
Pentalobe



The security profile for Apple devices.

- Ideal for repairing Apple smartphones, tablets and notebooks.
- Note: The guarantee and warranty conditions of the device manufacturer must be observed.

Small screwdriver



☉ Slotted transparent-red, with push-on clip

500

Order-No.	☉	↔	●	mm	+	📦
01537	3,0	40	3,0	100	11	50
01538	3,0	60	3,0	120	11	50
01539	3,0	80	3,0	140	11	50

Replacement blade set 20 mm wide



10-pcs. for universal scraper in blister pack

SB 430 40 K1020

Order-No.	📦
27902	5

Small screwdriver



☉ Slotted transparent-yellow

509

Order-No.	☉	↔	●	mm	+	📦
01548	2,0	40	2,0	85	8	50

Replacement blade set 13 mm wide



10-pcs. for universal scraper in blister pack

SB 430 40 K10

Order-No.	📦
27606	5

Universal scraper SoftFinish®



430 40

Order-No.	📦
23159	5

Magnetiser



400 10

Order-No.	📦
01508	5

Universal scraper set SoftFinish®



10-pcs. in blister pack

SB 430 4010

Order-No.	📦
26920	1

in blister pack

SB 400 10

Order-No.	📦
02568	5

Screwdriver MicroFinish®



Slotted, Phillips 6-pcs.

5520 HK6

Order-No.	
29124	1
⊖	3,5 x 100 / 4,0 x 100 / 5,5 x 125 / 6,5 x 150
⊕	PH1 x 80 / PH2 x 100

Slotted, Pozidriv 6-pcs.

5520 ZK6

Order-No.	
29125	1
⊖	3,5 x 100 / 4,0 x 100 / 5,5 x 125 / 6,5 x 150
⊕	PZ1 x 80 / PZ2 x 100

TORX® 6-pcs.

5527 K6

Order-No.	
29169	1
⊕	T10 x 80 / T15 x 80 / T20 x 100 / T25 x 100 / T30 x 115 / T40 x 130

Screwdriver MicroFinish®



Slotted, Phillips with one-piece hexagonal blade and solid steel cap, 5-pcs.

5533 HK5

Order-No.	
29138	1
⊖	5,5 x 100 / 6,5 x 125 / 8,0 x 150
⊕	PH1 x 80 / PH2 x 100

Slotted, Pozidriv with one-piece hexagonal blade and solid steel cap, 5-pcs.

5533 ZK5

Order-No.	
29139	1
⊖	5,5 x 100 / 6,5 x 125 / 8,0 x 150
⊕	PZ1 x 80 / PZ2 x 100

Screwdriver MicroFinish®



⊖ Slotted with round blade

5520

Order-No.	⊖		⊖	●	mm		
29115	3,5	100	0,6	3.5	204	23	10
29116	4,0	100	0,8	4.0	211	30	10
29117	4,0•	150	0,8	4.0	261	30	10
29118	5,5	125	1,0	5.5	236	30	10
29119	5,5	150	1,0	5.5	261	30	10
29120	6,5	150	1,2	6.0	268	36	10
29121	8,0	150	1,2	7.0	274	41	10
29122	8,0	175	1,2	7.0	299	41	10
29123	10,0•	200	1,6	8.0	324	41	5

• Additional dimension. Non-DIN size.
DIN 5265, ISO 2380.

⊕ Phillips with round blade

5521

Order-No.	⊕		●	mm		
29140	PH0	60	3,0	165	23	10
29141	PH1	80	4,5	192	30	10
29142	PH1•	200	4,5	312	30	5
29143	PH2	100	6,0	220	36	10
29144	PH2•	200	6,0	320	36	5
29145	PH3•	150	8,0	277	41	10

• Additional dimension. Non-DIN size.
DIN ISO 8764-PH.

INFOBOX:
Wiha MicroFinish
screwdriver



The specialist for wet and oily applications.

- Due to the micro-fine surface structure of the screwdriver handle, the user can gain an optimal hold, even with oily or wet hands.
- The position of the soft and hard zones on the handle also supports the perfect grip for quick and powerful turning.

⊕ Pozidriv with round blade

5522

Order-No.	⊕	↔	●	mm	↔	📦
29152	PZ1	80	4,5	192	30	10
29153	PZ2	100	6,0	220	36	10
29154	PZ3	150	8,0	277	41	10

DIN ISO 8764-PZ.

⊕ TORX® with round blade

5527

Order-No.	⊕	↔	●	mm	↔	📦
29161	T9	60	4,0	172	30	10
29162	T10	80	4,0	192	30	10
29163	T15	80	4,0	192	30	10
29164	T20	100	4,0	212	30	10
29165	T25	100	4,5	212	30	10
29166	T27	115	5,5	235	36	10
29167	T30	115	6,0	235	36	10
29168	T40	130	7,0	257	41	5

○ Hexagon nut driver with round blade

5525

Order-No.	○	↔	mm	↔	📦
29170	5,5	125	237	30 7,9	10
29171	6	125	237	30 8,9	10
29172	7	125	245	36 10,9	10
29173	8	125	245	36 11,9	10
29174	10	125	245	36 14,4	10

Screwdriver MicroFinish®



○ Hexagon nut driver with flexible shaft

5528

Order-No.	○	↔	mm	↔	📦
29175	6	150	262	30 9	10
29176	7	150	270	36 11	10
29177	8	150	270	36 12	10

Screwdriver MicroFinish®



⊖ Slotted with one-piece hexagonal blade and solid steel cap

5533

Order-No.	⊖	↔	⊖	●	○	mm	↔	📦
29133	4,5•	90	0,8	4.0	-	201	30	10
29134	5,5	100	1,0	5.0	8	213	30	10
29135	6,5	125	1,2	6.0	10	238	36	10
29136	8,0	150	1,2	8.0	13	271	41	10
29137	10,0•	175	1,6	8.0	13	296	41	5

• Additional dimension. Non-DIN size.
DIN 5265, ISO 2380.

⊕ Phillips with one-piece hexagonal blade and solid steel cap

5534

Order-No.	⊕	↔	⊕	○	mm	↔	📦
29149	PH1	80	5,0	8	187	30	10
29150	PH2	100	6,0	10	214	36	10
29151	PH3	150	8,0	13	271	41	10

DIN ISO 8764-PH.

⊕ Pozidriv with one-piece hexagonal blade and solid steel cap

5535

Order-No.	⊕	↔	⊕	○	mm	↔	📦
29158	PZ1	80	5,0	8	187	30	10
29159	PZ2	100	6,0	10	214	36	10
29160	PZ3	150	8,0	13	271	41	5

DIN ISO 8764-PZ.

Screw extractor set



Hexagon with spiral drill bit 8-pcs.

405 11

Order-No.	📦
03988	10
●	2,0 / 2,5 / 3,0 / 4 / 5 / 6 / 8 / 10

Screw extractor



Order-No.	●	mm	●	405
03847	2,0	85	6,0	10
03848	2,5	85	6,0	10
03849	3,0	85	6,0	10
03850	4	85	6,0	10
03851	5	85	6,0	10
03852	6	95	8,0	10
03853	8	95	10,0	10
03854	10	110	12,0	10

Screwdriver set SoftFinish® ESD



Slotted, Phillips 5-pcs.

302ESD HK5 01

Order-No.	☐	1
27252	3,0 x 100 / 4,0 x 100	1
	PH0 x 60 / PH1 x 80 / PH2 x 100	

IEC 61340-5-1.

TORX® 5-pcs.

362ESD K5

Order-No.	☐	1
27253	T6 x 60 / T8 x 60 / T9 x 60 / T10 x 80 / T15 x 80	1

IEC 61340-5-1.

Screwdriver set Precision ESD



Slotted, Phillips 6-pcs.

272 K6

Order-No.	☐	1
08463	1,5 x 40 / 2,0 x 40 / 2,5 x 50 / 3,0 x 50	1
	PH00 x 40 / PH0 x 50	

IEC 61340-5-1.

TORX® 6-pcs.

278 K6

Order-No.	☐	1
26919	T5 x 40 / T6 x 40 / T7 x 40 / T8 x 40 / T10 x 50 / T15 x 60	1

IEC 61340-5-1.

Hexagon 6-pcs.

275 K6

Order-No.	☐	1
32278	0,9 x 40 / 1,3 x 40 / 1,5 x 50 / 2 x 50 / 2,5 x 60 / 3 x 60	1

IEC 61340-5-1.

Hexagon nut driver 6-pcs.

277 K6

Order-No.	☐	1
32279	2,5 x 60 / 3 x 60 / 3,5 x 60 / 4 x 60 / 5 x 60 / 5,5 x 60	1

IEC 61340-5-1.

INFOBOX: Electrostatic conductive ESD tools

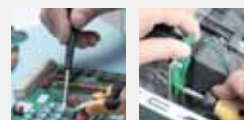

Sensitive, electronic components can be damaged even at a very low voltage.

- Dissipative tools by Wiha discharge the electrostatic energy in a controlled, safe manner.
- ESD tools meet the ESD Standard IEC 61340-5-1.
- ESD tool handles have a surface resistance of $10^6 - 10^9$ Ohm.

Screwdriver SoftFinish® ESD



⊖ Slotted

302ESD

Order-No.	⊖	↔	⊖	●	mm	↔	📦
08179	2,5	75	0,4	2,5	179	23	10
27150	3,0	100	0,5	3,0	204	23	10
27151	4,0	100	0,8	4,0	211	30	10
08182	5,5	125	1,0	5,5	236	30	10
08183	6,5	150	1,2	6,0	268	36	10

IEC 61340-5-1.

⊕ Phillips

311ESD

Order-No.	⊕	↔	●	mm	↔	📦
08184	PH0	60	3,0	164	23	10
08185	PH1	80	4,5	191	30	10
08186	PH2	100	6,0	218	36	10

IEC 61340-5-1.

⊕ Pozidriv

313ESD

Order-No.	⊕	↔	●	mm	↔	📦
26928	PZ0	60	3,0	164	23	10
26929	PZ1	80	4,5	191	30	10

IEC 61340-5-1.

⊕ TORX®

362ESD

Order-No.	⊕	↔	●	mm	↔	📦
31432	T3	60	2,5	164	23	10
27148	T4	60	2,5	164	23	10
27641	T5	60	3,5	164	23	10
27149	T6	60	3,5	164	23	10
31901	T7	60	3,5	164	23	10
22436	T8	60	3,5	164	23	10
27145	T9	60	4,0	171	30	10
27144	T10	80	4,0	191	30	10
27146	T15	80	4,0	191	30	10
27147	T20	100	4,0	218	36	10

IEC 61340-5-1.

Screwdriver SoftFinish® ESD



⊖ Slotted Stubby

302ESD

Order-No.	⊖	↔	⊖	●	mm	↔	📦
32151	4,0	25	0,8	4,0	81	34	10
32152	5,5	25	1,0	5,5	81	34	10
32153	6,5	25	1,2	6,5	81	34	10

IEC 61340-5-1.

⊕ Phillips Stubby

311ESD

Order-No.	⊕	↔	●	mm	↔	📦
32154	PH1	25	4,5	81	34	10
32155	PH2	25	6,0	81	34	10

IEC 61340-5-1.

⊕ Pozidriv Stubby

313ESD

Order-No.	⊕	↔	●	mm	↔	📦
32156	PZ1	25	4,5	81	34	10
32157	PZ2	25	6,0	81	34	10

IEC 61340-5-1.

Precision ESD lifter



279-10

Order-No.	↔	↔	mm	↔	📦
07667	3,5	50	145	13,0	5

IEC 61340-5-1.



Slotted

Order-No.	⊖	↔	⊖	●	mm	↔	📦
07634	1,5	40	0,25	2.0	120	12,5	10
07635	2,0	40	0,40	2.0	120	12,5	10
07636	2,5	50	0,40	2.5	145	13,0	10
07637	3,0	50	0,50	3.0	145	13,0	10
07638	3,5	60	0,60	3.5	170	14,0	10
07639	4,0	60	0,80	4.0	170	14,0	10

IEC 61340-5-1.

Phillips

Order-No.	⊕	↔	●	mm	↔	📦
28053	PH000	40	2,0	120	12,5	10
07640	PH00	40	2,0	120	12,5	10
07641	PH0	50	3,0	145	13,0	10
07642	PH1	60	4,0	170	14,0	10

IEC 61340-5-1.

Pozidriv

Order-No.	⊕	↔	●	mm	↔	📦
07643	PZ1	60	4,0	170	14	10

IEC 61340-5-1.

TORX® MagicSpring®

Order-No.	⊕	↔	●	mm	↔	📦
27748	T6	40	2,5	120	12,5	10
27749	T7	40	2,5	120	12,5	10
27759	T8	40	2,5	120	12,5	10
27750	T9	50	3,0	145	13,0	10
27751	T10	50	3,0	145	13,0	10
27752	T15	60	3,5	170	14,0	10

IEC 61340-5-1.

TORX®

Order-No.	⊕	↔	●	mm	↔	📦
25676	T1	40	2,5	120	12,5	10
25677	T2	40	2,5	120	12,5	10
21256	T3	40	2,5	120	12,5	10
21255	T4	40	2,5	120	12,5	10
07659	T5	40	2,5	120	12,5	10
07660	T6	40	2,5	120	12,5	10
07661	T7	40	2,5	120	12,5	10
07662	T8	40	2,5	120	12,5	10
07663	T9	50	3,0	145	13,0	10
07664	T10	50	3,0	145	13,0	10
07665	T15	60	3,5	170	14,0	10
07666	T20	60	4,0	170	14,0	10

IEC 61340-5-1.

272

TORX PLUS®

Order-No.	⊕	↔	●	mm	↔	📦
28198	4IP	40	2,5	120	12,5	10
27761	5IP	40	2,5	120	12,5	10
27762	6IP	40	2,5	120	12,5	10
27763	7IP	40	2,5	120	12,5	10
27764	8IP	40	2,5	120	12,5	10
27765	9IP	50	3,0	145	13,0	10
27766	10IP	50	3,0	145	13,0	10
27767	15IP	60	3,5	170	14,0	10

IEC 61340-5-1.

278IP

Ball end hex

Order-No.	●	↔	mm	↔	📦
07649	1,5	50	145	13,0	10
07650	2	50	145	13,0	10
07651	2,5	60	170	14,0	10
07652	3	60	170	14,0	10

IEC 61340-5-1.

276

Hex

Order-No.	●	↔	mm	↔	📦
27707	0,7	40	120	12,5	10
27708	0,9	40	120	12,5	10
07644	1,3	40	120	12,5	10
07645	1,5	50	145	13,0	10
07646	2	50	145	13,0	10
07647	2,5	60	170	14,0	10
07648	3	60	170	14,0	10
32315	4	60	170	14,0	10

IEC 61340-5-1.

275

Hex nut driver

Order-No.	○	↔	□	□	mm	↔	📦
32312	1,5	60	2,5	-	155	13,0	10
32313	2,0	60	2,9	-	155	13,0	10
07653	2,5	60	4,0	4.0	155	13,0	10
07654	3	60	5,0	5.0	155	13,0	10
07655	3,5	60	5,3	6.0	155	13,0	10
07656	4	60	5,5	6.0	155	13,0	10
32314	4,5	60	6,2	7.0	155	13,0	10
07657	5	60	6,8	7.0	155	13,0	10
07658	5,5	60	7,6	8.0	170	14,0	10

IEC 61340-5-1.

277



Torque screwdriver
Controlled power for greater security.

The correct torque prevents damage to materials, eliminates the need for retouching and protects against warranty claims. This makes fully certified Wiha torque tools essential for mechanics, electricians and electronics technicians as they combine precision with security: with a release accuracy of $\pm 6\%$ for the pre-set scale value, Wiha torque screwdrivers satisfy standard precision requirements.

Torque tools with fixed settings increase process reliability while tools with variable settings are particularly ideal for mobile use. A special interchangeable blade system offers interchangeable blades with different drives. Guaranteed individual item testing using the manufacturer's inspection process and individual item marking with an identification number attest to the high quality and manufacturing standard of the tools.

Application Torque screwdriver

For applications in electrics



Torque screwdriver set TorqueVario®-S electric
assorted, variably adjustable torque limit, 18-pcs. in bag
Page 162



Torque screwdriver TorqueVario®-S electric
Variable torque limit settings
Page 163



easyTorque electric torque adapter
Page 164



Torque screwdriver with T-handle TorqueVario®-S T electric
Variable torque limit settings
Page 165



For applications in mechanics



Torque screwdriver iTorque® with digital scale
Page 168



Torque screwdriver set TorqueVario®-S
assorted variably adjustable, 13-pcs. in box
Page 168



Torque screwdriver TorqueVario®-S
Variable torque limit settings
Page 168



Torque screwdriver TorqueFix® permanently pre-set torque limit
Page 169



Torque screwdriver with T-handle set TorqueVario®-S T
assorted, variably adjustable torque limit, 11-pcs. in box
Page 172



Torque screwdriver with T-handle TorqueVario®-S T
Variable torque limit settings
Page 172



For applications in electronics



Torque screwdriver set TorqueVario®-S ESD
assorted, variably adjustable torque limit, 13-pcs. in box
Page 175



Torque screwdriver TorqueVario®-S ESD
Variable torque limit settings
Page 175





assorted, variably adjustable torque limit, 18-pcs. in bag

2872 T18

Order-No.



36791

1

○ 1 x Torque screwdriver TorqueVario®-S electric Variable torque limit settings, Tool tested at 10,000 V AC / 0,8 - 5,0 Nm

1 x Adjusting tool for torque screwdriver with long handle

○ 1 x slimBit bit holder electric, locked mechanically For VDE torque screwdriver with long handle

⊖ 1 x 2,5 / 1 x 3,5 / 1 x 5,5 / 1 x 6,5

⊕ 1 x PH1 / 1 x PH2

⊕ 1 x PZ1 / 1 x PZ2

⊕ 1 x SL/PZ1 / 1 x SL/PZ2

⊕ 1 x T9 / 1 x T10 / 1 x T15 / 1 x T20 / 1 x T25

Manufactured acc. to IEC 60900. DIN EN ISO 6789.

INFOBOX: VDE-certified tools



Wiha VDE-tested tools are subject to stringent safety test procedures.

All tools with the special marking have been tested at 10,000 V AC and are therefore approved for use at 1,000 V AC and 1,500 V DC.

The following equipment is required for all work on or around live components and should be appropriate for the specific task

- insulating personal protective equipment
- insulating safety mechanisms
- insulated tools

Before starting work, you must disconnect all active, live components of electrical machines and equipment and ensure that they remain disconnected while you carry out the work.

This is achieved by complying with the five safety rules:

- disconnect
- secure against reconnection
- ensure power is switched off
- earth and short-circuit
- cover or block off adjacent live components

Certified by the VDE Testing and Certification Institute and individually tested according to the international standard IEC 60900.

Torque screwdriver set TorqueVario®-S electric



assorted, variably adjustable torque limit, 13-pcs. in bag

2872 T13

Order-No.



40674

1

- 1 x Torque screwdriver TorqueVario®-S electric Variable torque limit settings, Tool tested at 10,000 V AC / 0,8 - 5,0 Nm
- 1 x Adjusting tool for torque screwdriver with long handle
- 1 x Screwdriver with bit holder SoftFinish® electric slimVario For slimBits, Tool tested at 10,000 V AC
- 1 x slimBit bit holder electric, locked mechanically For VDE torque screwdriver with long handle
- ⊖ 1 x 2,5 / 1 x 3,5 / 1 x 5,5
- ⊕ 1 x PH1 / 1 x PH2
- ⊕ 1 x PZ1 / 1 x PZ2
- ⊕ 1 x SL/PZ1 / 1 x SL/PZ2

Manufactured acc. to IEC 60900. DIN EN ISO 6789.

Torque screwdriver set TorqueVario®-S electric



PlusMinus/Pozidriv variably settable torque limit 5-pcs.

2872 S3

Order-No.



38074

1

- 1 x Torque screwdriver TorqueVario®-S electric Variable torque limit settings, Tool tested at 10,000 V AC / 0,8 - 5,0 Nm
- 1 x slimBit bit holder electric, locked mechanically For VDE torque screwdriver with long handle
- 1 x Adjusting tool for torque screwdriver with long handle
- ⊕ 1 x SL/PZ1 / 1 x SL/PZ2

Manufactured acc. to IEC 60900. DIN EN ISO 6789.

Torque screwdriver TorqueVario®-S electric



Variable torque limit settings

2872

Order-No.	Nm	±%	⊖	⊕	⊕	⊕
26625	0,5-2,0	6 %	3,8	131	30	1
26626	0,8-5,0	6 %	3,8	138	36	1
26627	2,0-7,0	6 %	3,8	142	41	1

Manufactured acc. to IEC 60900. DIN EN ISO 6789.

easyTorque torque set electric adapter



with slimVario® holder and SL/PZ slimBits, 4-pcs. in blister pack

29701 080 S4

Order-No.	
41476	1
	1 x 0,8 Nm
	1 x SL/PZ1 / 1 x SL/PZ2
	1 x SoftFinish® electric screwdriver handle
Manufactured acc. to IEC 60900.	

with slimVario® holder and SL/PZ slimBits, 4-pcs. in blister pack

29701 200 S4

Order-No.	
41477	1
	1 x 2,0 Nm
	1 x SL/PZ1 / 1 x SL/PZ2
	1 x SoftFinish® electric screwdriver handle
Manufactured acc. to IEC 60900.	

with slimVario® holder and SL/PZ slimBits, 4-pcs. in blister pack

29701 280 S4

Order-No.	
41478	1
	1 x 2,8 Nm
	1 x SL/PZ1 / 1 x SL/PZ2
	1 x SoftFinish® electric screwdriver handle
Manufactured acc. to IEC 60900.	

easyTorque torque set electric adapter



for slimBits and slimVario® holder, 5-pcs. in blister pack

29701 S5

Order-No.	
41479	1
	1 x 0,8 Nm / 1 x 2,0 Nm / 1 x 2,5 Nm / 1 x 2,8 Nm / 1 x 4,0 Nm
Manufactured acc. to IEC 60900.	

easyTorque electric torque adapter



for slimBits and slimVario® holder in blister

2970

Order-No.	Nm	±%	mm		
41341	0,8	10 %	59	5,5	1
41342	2,0	10 %	59	5,5	1
41343	2,5	10 %	59	5,5	1
41344	2,8	10 %	59	5,5	1
41345	4,0	10 %	59	5,5	1
Manufactured acc. to IEC 60900.					

slimBit electric bit set



assorted with slimBit holder, 7-pcs.

2879 B7

Order-No.	
36079	1
	1 x slimBit bit holder electric, locked mechanically For VDE torque screwdriver with long handle
	1 x 4,0 / 1 x 5,5
	1 x PH1 / 1 x PH2
	1 x PZ1 / 1 x PZ2
Manufactured acc. to IEC 60900.	

slimBit bit holder electric, locked mechanically



For VDE torque screwdriver with long handle

28799

Order-No.					
35870	6	3,8	170	13	10
Manufactured acc. to IEC 60900.					

Nut driver adapter blade electric 1/4"



For VDE torque screwdriver with long handle

28799

Order-No.					
43128	1/4	3,8	178	12	10
Manufactured acc. to IEC 60900.					

slimBit electric bit set



TORX®, 6-pcs. in box

2831-B604

Order-No.	
42210	6
	1 x T8 / 1 x T9 / 1 x T10 / 1 x T15 / 1 x T20 / 1 x T25
Manufactured acc. to IEC 60900.	

Slotted, Pozidriv, 6-pcs. in box

2831-B605

Order-No.	
42211	6
	1 x 2,5 / 1 x 3,5 / 1 x 5,5 / 1 x 6,5
	1 x PZ1 / 1 x PZ2
Manufactured acc. to IEC 60900.	

Slotted, Phillips, 6-pcs. in box

2831-B606

Order-No.	
42212	6
	1 x 6,5 / 1 x 2,5 / 1 x 5,5 / 1 x 3,5
	1 x PH1 / 1 x PH2
Manufactured acc. to IEC 60900.	

Slotted, PlusMinus/Pozidriv, 6-pcs. in box

2831-B607

Order-No.	
42213	6
	1 x 2,5 / 1 x 3,5 / 1 x 5,5 / 1 x 6,5
	1 x SL/PZ1 / 1 x SL/PZ2
Manufactured acc. to IEC 60900.	

Hex, 6-pcs. in box

2831-B608

Order-No.	
42214	6
	1 x 2 / 1 x 2,5 / 1 x 3 / 1 x 4 / 1 x 5 / 1 x 6
Manufactured acc. to IEC 60900.	



Slotted

2831-10

Order-No.	mm	mm	mm	max. Nm	
34578	2,5	75	0,4	6,0	0,4
34579	3,0	75	0,5	6,0	0,6
41159	3,5	75	0,6	6,0	2,5
34580	4,0	75	0,8	6,0	2,5
34581	5,5	75	1,0	6,0	5,5
34582	6,5	75	1,2	6,0	5,5

• no slim version
Manufactured acc. to IEC 60900.

Phillips

2831-11

Order-No.	mm	mm	mm	max. Nm	
34583	PH1	75	6,0	3,8	
34584	PH2	75	6,0	5,5	

Manufactured acc. to IEC 60900.

Pozidriv

2831-12

Order-No.	mm	mm	mm	max. Nm	
34585	PZ1	75	6,0	3,8	
34586	PZ2	75	6,0	5,5	

Manufactured acc. to IEC 60900.

PlusMinus/Phillips

2831-13

Order-No.	mm	mm	mm	max. Nm	
34587	SL/PH1	75	6,0	3,8	
34588	SL/PH2	75	6,0	5,5	

Manufactured acc. to IEC 60900.

PlusMinus/Pozidriv

2831-14

Order-No.	mm	mm	mm	max. Nm	
34589	SL/PZ1	75	6,0	3,8	
34590	SL/PZ2	75	6,0	5,5	

Manufactured acc. to IEC 60900.

TORX®

2831-15

Order-No.	mm	mm	mm	max. Nm	
35506	T8	75	6,0	1,3	
41160	T9	75	6,0	1,3	
35507	T10	75	6,0	3,8	
35508	T15	75	6,0	5,0	
35509	T20	75	6,0	5,5	
36071	T25	75	6,0	5,5	

• no slim version
Manufactured acc. to IEC 60900.

Hex

2831-18

Order-No.	mm	mm	mm	max. Nm	
37222	1,5	75	6,0	0,9	
37223	2	75	6,0	1,8	
37224	2,5	75	6,0	3,8	
37147	3	75	6,0	5,5	
37225	4	75	6,0	5,5	
37226	5	75	6,0	5,5	
37227	6	75	6,0	5,5	

• no slim version
Manufactured acc. to IEC 60900.

Square

2831-17

Order-No.	mm	mm	mm	mm	max. Nm	
35510	#1	2,3	75	6,0	5,5	
35511	#2	2,8	75	6,0	5,5	

Manufactured acc. to IEC 60900.

INFOBOX: slimTECHNOLOGY



Wiha SoftFinish® electric slimFix

- Unlimited access.
- Blades up to 33 % narrower due to integrated insulation.
- Tool for spring clips (wedge-profiled output geometry).

Torque screwdriver iTorque®



○ with digital scale

28352

Order-No.	Nm	oz	±%	○	⇄	⇅	📦
36886	0,4-1,5	60-210 in.oz	6%	4	134	34	1
36887	0,8-3,0	7-26 in.lbs	6%	4	134	34	1
36888	1,0-5,0	9-44 in.lbs	6%	4	134	40	1

DIN EN ISO 6789.

Torque screwdriver TorqueVario®-S



○ Variable torque limit settings

2852

Order-No.	Nm	±%	○	⇄	⇅	📦
36849	0,04-0,46	10%	4	127	23	1
26888	0,1-0,6	10%	4	127	23	1
36850	0,1-0,6	6%	4	127	23	1
26461	0,4-1,0	6%	4	127	23	1
26462	0,5-2,0	6%	4	131	30	1
26463	0,8-5,0	6%	4	138	36	1
26464	2,0-7,0	6%	4	142	41	1

• Precision in range of 0.1-0.46 Nm. DIN EN ISO 6789.

INFOBOX: iTorque



The intelligent torque tool.

- Required torque can be adjusted and set on the handle without the need for a separate tool.
- Large numerical display simplifies reading.
- ClickControl records every use and optimises the monitoring of measuring instruments.
- Calibration alarm after 5,000 applications for absolute process safety.
- Certified individual item testing directly after on-site production.
- Broad selection of interchangeable blades and adapter blades.
- Units can be switched (Nm » in.lb/ cNm » in.oz)
- Can be recalibrated

Torque screwdriver set TorqueVario®-S



assorted variably adjustable, 13-pcs. in box

2852 S10

Order-No.	📦
26893	1

- Torque screwdriver TorqueVario®-S Variable torque limit settings 0,8 - 5,0 Nm
- Bit holder clamping with ball for torque screwdriver with long handle
- Adjusting tool for torque screwdriver with long handle
- ⊕ PH1 x 25 / PH2 x 25
- ⊗ PZ1 x 25 / PZ2 x 25
- ⊗ T10 x 25 / T15 x 25 / T20 x 25 / T25 x 25
- ⊗ 3,0 x 25 / 4,0 x 25

DIN EN ISO 6789.

TORX®, TORX PLUS® with variably adjustable torque limit, 13-pcs. in box

2852 S10-01

Order-No.	📦
34614	1

- Torque screwdriver TorqueVario®-S Variable torque limit settings 0,8 - 5,0 Nm
- Bit holder clamping with ball for torque screwdriver with long handle
- Adjusting tool for torque screwdriver with long handle
- ⊗ T7 x 25 / T8 x 25 / T9 x 25 / T10 x 25 / T15 x 25
- ⊗ 7IP x 25 / 8IP x 25 / 9IP x 25 / 10IP x 25 / 15IP x 25

DIN EN ISO 6789.

Torque screwdriver TorqueFix®



○ permanently pre-set torque limit

2850

Order-No.	Nm	±6%	○	mm	mm	mm	mm	mm	mm
26925	0,4	6%	4	112	23				1
26127	0,5	6%	4	112	23				1
26047	0,6	6%	4	112	23				1
26327	0,8	6%	4	112	23				1
26048	0,9	6%	4	112	23				1
26133	1,1	6%	4	119	30				1
26049	1,2	6%	4	119	30				1
26901	1,5	6%	4	119	30				1
26051	2,0	6%	4	119	30				1
26128	2,5	6%	4	119	36				1
26052	3,0	6%	4	126	36				1
26129	3,8	6%	4	126	36				1
26053	5,0	6%	4	132	41				1
26130	5,5	6%	4	132	41				1
34533	6,0	6%	4	132	41				1
26131	7,2	6%	4	132	41				1

DIN EN ISO 6789.

Torque screwdriver set TorqueFix®



Cable key for circular plug connector permanently pre-set torque limit 2-pcs.

2850

Order-No.	Nm	mm	mm	mm	mm	mm	mm	mm
36846	0,4	9	230	78	112	23		1
36847	0,6	13	230	78	112	23		1

DIN EN ISO 6789.

Torque screwdriver easyTorque



○ permanently pre-set torque limit

2920

Order-No.	Nm	±10%	○	mm	mm	mm	mm	mm
36229	0,5	10%	4	130	34			1
36230	0,6	10%	4	130	34			1
36240	0,9	10%	4	130	34			1
36231	1,1	10%	4	130	34			1
36233	1,2	10%	4	130	34			1
36234	1,4	10%	4	130	34			1
36235	2,0	10%	4	130	34			1
36236	2,5	10%	4	130	34			1
36237	3,0	10%	4	130	34			1
36238	3,8	10%	4	130	34			1
36320	4,0	10%	4	130	34			1
36321	4,5	10%	4	130	34			1
36239	5,0	10%	4	130	34			1

INFOBOX: TorqueVario®-S



Variably settable torque tools.

- For controlled fastening in a large range of applications.
- Torque value is continuously adjustable thanks to the torque setter adjusting tool.
- Distinctly audible and perceptible click signal when set torque is reached.
- Each Wiha screwdriver handle provides a perfectly correlated ratio of guidance, speed and torque for any fastening task.
- Certified individual item testing directly after on-site production.
- Broad selection of interchangeable blades and adapter blades.

INFOBOX: TorqueFix®



Permanently pre-set torque tools.

- For controlled fastening, e.g. in series production or repetitive usage.
- Distinctly audible and perceptible click signal when set torque is reached.
- Each Wiha screwdriver handle provides a perfectly correlated ratio of guidance, speed and torque for any fastening task.
- Broad selection of interchangeable blades and adapter blades.



⊖ Slotted for torque screwdriver with long handle

28590

Order-No.	⊖	⊖	mm	mm	mm	max. Nm	
26227	0,25	1,5	4	175	42	0,15	10
26228	0,4	2,0	4	175	42	0,4	10
26151	0,4	2,5	4	175	42	0,4	10
26277	0,5	3,0	4	175	42	0,6	10
26278	0,6	3,5	4	175	42	1,1	10
26279	0,8	4,0	4	175	42	2,5	10

Blade tip DIN ISO 2380-1.

⊕ Phillips for torque screwdriver with long handle

28591

Order-No.	⊕	mm	mm	mm	max. Nm	
26199	PH000	4	175	42	0,4	10
26196	PH00	4	175	42	0,4	10
26197	PH0	4	175	42	0,9	10
26058	PH1	4	175	42	3,8	10
27079	PH2	4	175	42	5,5	10

Blade tip DIN ISO 8764-1.

⊕ Pozidriv for torque screwdriver with long handle

28592

Order-No.	⊕	mm	mm	mm	max. Nm	
26198	PZ0	4	175	42	0,9	10
26148	PZ1	4	175	42	3,8	10
26889	PZ2	4	175	42	5,5	10

Blade tip DIN ISO 8764-1.

⊕ TORX® MagicSpring® for torque screwdriver with long handle

28595R

Order-No.	⊕	mm	mm	mm	max. Nm	
27818	T6	4	175	42	0,6	10
27812	T7	4	175	42	0,9	10
27813	T8	4	175	42	1,3	10
27814	T9	4	175	42	2,5	10
27815	T10	4	175	42	3,8	10
27816	T15	4	175	42	5,5	10
27817	T20	4	175	42	8,0	10
29467	T25	4	175	42	8,0	10

⊕ TORX® for torque screwdriver with long handle

28595

Order-No.	⊕	mm	mm	mm	max. Nm	
30852	T4	4	175	42	0,25	10
26158	T5	4	175	42	0,4	10
26064	T6	4	175	42	0,6	10
26065	T7	4	175	42	0,9	10
26066	T8	4	175	42	1,3	10
26059	T9	4	175	42	2,5	10
26067	T10	4	175	42	3,8	10
26068	T15	4	175	42	5,5	10
26069	T20	4	175	42	8,0	10
26070	T25	4	175	42	8,0	10

⊕ TORX PLUS® MagicSpring® for torque screwdriver with long handle

28596R

Order-No.	⊕	mm	mm	mm	max. Nm	
29553	6IP	4	175	42	0,8	10
29554	7IP	4	175	42	1,3	10
29555	8IP	4	175	42	2,0	10
29556	9IP	4	175	42	3,0	10
29557	10IP	4	175	42	4,5	10
29558	15IP	4	175	42	6,6	10
29559	20IP	4	175	42	8,0	10
29560	25IP	4	175	42	8,0	10

⊕ TORX PLUS® for torque screwdriver with long handle

28596

Order-No.	⊕	mm	mm	mm	max. Nm	
26159	5IP	4	175	42	0,5	10
26071	6IP	4	175	42	0,8	10
26152	7IP	4	175	42	1,3	10
26072	8IP	4	175	42	2,0	10
26154	9IP	4	175	42	3,0	10
26155	10IP	4	175	42	4,5	10
26073	15IP	4	175	42	6,6	10
26156	20IP	4	175	42	8,0	10
26157	25IP	4	175	42	8,0	10

● Hexagonal ball end for torque screwdriver with long handle

28597

Order-No.	●	●	mm	mm	max. Nm	
26221	1,5	4	175	42	0,4	10
26222	2,0	4	175	42	0,9	10
26223	2,5	4	175	42	2,0	10
26224	3,0	4	175	42	3,8	10
26225	4,0	4	175	42	8,0	10

● Hexagon for torque screwdriver with long handle

28593

Order-No.	●	●	mm	mm	max. Nm	
26544	1,3	4	175	42	0,4	10
26200	1,5	4	175	42	0,9	10
26060	2,0	4	175	42	1,8	10
26061	2,5	4	175	42	3,8	10
26062	3,0	4	175	42	5,5	10
26063	4,0	4	175	42	8,0	10

Cable key for circular plug connector



○ Hexagon head for torque screwdriver with long handle

28594

Order-No.	○	●	mm	mm	max. Nm	
36414	8	4	78	218	1	10
36415	9	4	78	218	1	10
36417	13	4	78	218	1,5	10
36418	14	4	78	218	1,5	10
36421	18	4	78	218	1,5	5

Adapter blade



□ internal square for torque screwdriver with long handle

285992

Order-No.	□	●	mm	
26229	1/4	4	155	10

Bit holder clamping with ball



○ for torque screwdriver with long handle

285994

Order-No.	○	●	mm	mm	
27526	1/4	4	162	11	10

Adjusting tool



for torque screwdriver with long handle

2859

Order-No.	mm	mm	
26864	146	90	1

INFOBOX:
Ball end hex



Wiha hexagonal ball end

- The ball end can be rotated by up to 25° in both clockwise and anti-clockwise direction.

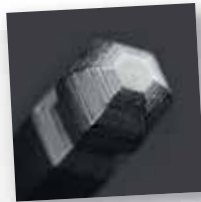

INFOBOX:
MagicSpring®



Wiha TORX® MagicSpring®

- TORX® and TORX PLUS® screws are held securely in place.
- An innovation, which will benefit each user.



Torque screwdriver with T-handle set TorqueVario®-S T



assorted, variably adjustable torque limit, 11-pcs. in box

2893 S01

Order-No.	
29234	1

- Torque screwdriver with T-handle TorqueVario®-S T Variable torque limit settings / 5 - 14 Nm
Adjusting tool for torque screwdriver with T-handle
 - Adapter blade for torque screwdriver with T-handle 1/4" / Adapter blade for torque screwdriver with T-handle 3/8"
 - Bit holder for torque screwdriver with T-handle
 - T25 x 25 / T30 x 25 / T40 x 25
 - 4,0 x 25 / 5,0 x 25 / 6,0 x 25
- DIN EN ISO 6789.

Torque screwdriver with T-handle TorqueVario®-S T



Variable torque limit settings

2893

Order-No.	Nm	±%				
29233	5-14	6%	6	56	120	1

DIN EN ISO 6789.

Torque screwdriver with T-handle TorqueFix® T



permanently pre-set torque limit

2891

Order-No.	Nm	±%				
29228	6	6%	6	56	120	1
29229	8	6%	6	56	120	1
29230	10	6%	6	56	120	1
29231	12	6%	6	56	120	1
29236	12,5	6%	6	56	120	1
29232	14	6%	6	56	120	1

DIN EN ISO 6789.

Interchangeable blade



TORX® for torque screwdriver with T-handle

28995

Order-No.			mm		max. Nm	max. in.lbs.	
28734	T15	6	130	53	5,5	49	10
28735	T20	6	130	53	10	88	10
28736	T25	6	130	53	15	132	10
28737	T27	6	130	53	15	132	10
28738	T30	6	130	53	15	132	10
28739	T40	6	130	53	15	132	10

TORX PLUS® for torque screwdriver with T-handle

28996

Order-No.			mm		max. Nm	max. in.lbs.	
28740	15IP	6	130	53	6,6	59	10
28741	20IP	6	130	53	13	115	10
28742	25IP	6	130	53	15	132	10
28743	27IP	6	130	53	15	132	10
28744	30IP	6	130	53	15	132	10
28745	40IP	6	130	53	15	132	10

Hex for torque screwdriver with T-handle

28993

Order-No.			mm		max. Nm	max. in.lbs.	
28746	3	6	130	53	5,5	49	10
28747	4	6	130	53	15	132	10
28748	5	6	130	53	15	132	10
28749	6	6	130	53	15	132	10

Adapter blade



for torque screwdriver with T-handle

28999

Order-No.			mm		
28756	1/4	6	120	53	10
28757	3/8	6	120	53	10

Bit holder



for torque screwdriver with T-handle

28999

Order-No.			mm		
28758	1/4	6	125	11	10

Adjusting tool



for torque screwdriver with T-handle

2899

Order-No.		mm	
28691	90	146	1



Torque screwdriver with key handle TorqueFix® Key



○ permanently pre-set torque limit

28360

Order-No.	Nm	±6%	○	⌘	↔	↔	
38616	0,5	6%	4	68	50		1
38617	0,6	6%	4	68	50		1
38618	0,9	6%	4	68	50		1
38556	1,1	6%	4	68	50		1
38800	1,2	6%	4	68	50		1
38619	1,4	6%	4	68	50		1
38557	2,0	6%	4	68	50		1
38620	2,5	6%	4	68	50		1
38621	3,0	6%	4	68	50		1
38558	3,8	6%	4	68	50		1
38622	4,0	6%	4	68	50		1

DIN EN ISO 6789.

Interchangeable blade



● TORX® for torque screwdriver with key handle

283695

Order-No.	⌘	⌘	mm	↔	max. Nm	SB	
38806	T6	4	75	20	0,6		10
38807	T7	4	75	20	0,9		10
38808	T8	4	75	20	1,3		10
38809	T9	4	75	20	2,5		10
38810	T10	4	75	20	3,8		10
38811	T15	4	75	20	5,5		10
38812	T20	4	75	20	8,0		10
38813	T25	4	75	20	8,0		10

Interchangeable blade



● TORX PLUS® for torque screwdriver with key handle

283696

Order-No.	⌘	⌘	mm	↔	max. Nm	
38814	6IP	4	75	20	0,8	10
38815	7IP	4	75	20	1,3	10
38816	8IP	4	75	20	2,0	10
38817	9IP	4	75	20	3,0	10
38818	10IP	4	75	20	4,5	10
38819	15IP	4	75	20	6,6	10
38820	20IP	4	75	20	8,0	10

Interchangeable blade



● Hexagon for torque screwdriver with key handle

283693

Order-No.	⌘	⌘	mm	↔	max. Nm	
38801	1,5	4	75	20	0,9	10
38802	2,0	4	75	20	1,8	10
38803	2,5	4	75	20	3,8	10
38804	3,0	4	75	20	5,5	10
38805	4,0	4	75	20	8,0	10

Torque screwdriver set TorqueVario®-S ESD



assorted, variably adjustable torque limit, 13-pcs. in box

2882 S10

Order-No.	Quantity	Description
27687	1	Torque screwdriver TorqueVario®-S ESD Variable torque limit settings ,0,5 - 2,0 Nm
		Bit holder clamping with ball for torque screwdriver with long handle
		Adjusting tool for torque screwdriver with long handle
		4,5 x 25 / 5,5 x 25
		PH0 x 25 / PH1 x 25
		PZ0 x 25 / PZ1 x 25
		T7 x 25 / T8 x 25 / T9 x 25 / T10 x 25

IEC 61340-5-1. DIN EN ISO 6789.

Torque screwdriver TorqueVario®-S ESD



Variable torque limit settings

2882

Order-No.	Nm	±%	⊙	⊞	⊞	⊞
36851	0,04-0,46	10%	4	127	23	1
26865	0,1-0,6	10%	4	127	23	1
36852	0,1-0,6	6%	4	127	23	1
26629	0,4-1,0	6%	4	127	23	1
26866	0,5-2,0	6%	4	131	30	1
30495	0,8-5,0	6%	4	138	36	1

* Precision in range of 0.1-0.46 Nm. IEC 61340-5-1. DIN EN ISO 6789.



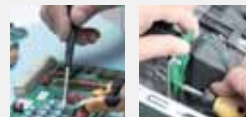







INFOBOX:
Electrostatic
conductive ESD
tools



Sensitive, electronic components can be damaged even at a very low voltage.

- Dissipative tools by Wiha discharge the electrostatic energy in a controlled, safe manner.
- ESD tools meet the ESD Standard IEC 61340-5-1.
- ESD tool handles have a surface resistance of $10^6 - 10^9$ Ohm.

Overview of torque tools

Tools	Precision	Setting	Special feature	Nm range	Torque range			
					0,01 Nm	0,1 Nm	1 Nm	10 Nm
iTorque 	± 6 %	variable	Écran digital Click control Calibration alarm Can be recalibrated	0,4 – 1,5 0,8 – 3,0 1,0 – 5,0				
TorqueVario®-S 	± 10 % ± 6 %/± 10 % ± 6 %	variable	Numeric scale	0,04 – 0,46 0,1 – 0,6 0,4 – 1,0 0,5 – 2,0 0,8 – 5,0 2,0 – 7,0				
TorqueVario®-S ESD 	± 10 % ± 6 %/± 10 % ± 6 %	variable	ESD-compliant, numeric scale	0,04 – 0,46 0,1 – 0,6 0,4 – 1,0 0,5 – 2,0 0,8 – 5,0				
TorqueFix® 	± 6 %	fixed	Permanently preset in factory	16 Versions 0,4 – 7,2				
easyTorque 	± 10 %	fixed	Permanently preset in factory	13 Versions 0,5 – 5,0				
TorqueFix® Key 	± 6 %	fixed	Permanently preset in factory	0,5 – 4,0				
easyTorque adapter 	± 10 %	fixed	VDE certifica- tion, Perma- nently preset in factory	5 Versions 0,8 – 4,0				
TorqueVario®-S VDE 	± 6 %	variable	VDE certifica- tion, numeric scale	0,5 – 2,0 0,8 – 5,0 2,0 – 7,0				
TorqueVario®-S T electric 		variable	VDE certification, numeric scale	5 – 14				
TorqueVario®-S T 	± 6 %	variable	Numeric scale	5,0 – 14				
TorqueFix®-T 	± 6 %	fixed	Permanently preset in factory	6 Versions 6,0 – 14				

Interchangeable blades

Series 2859



Series 28369

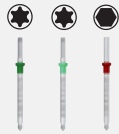

slimBits
Series 2831

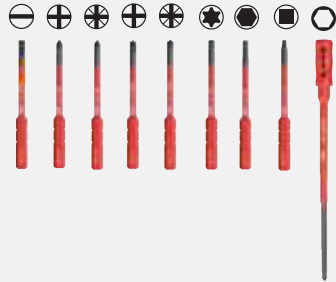

Series 28379



Series 2899





Multitools

Many talents in the minimum space.

Fewer tools mean less load, better handling and efficient work. The more a tool can do, the better: Wiha multitools are compact, versatile tools which save space and reduce overall weight, making them the perfect portable companion.

In the Wiha LiftUp magazine bit holder, the most commonly used bits are neatly stored in the handle, ensuring they are always ready for use and easy to handle. The Wiha reversible blade system offers a variety of interchangeable blades, the lengths of which can be adjusted as required. The small, compact Wiha PocketStars contain the most commonly used L-keys - indispensable helpers for all equipment. The Wiha Stubby magazine combines six drive formats in one, allowing completely unrestricted access to all confined spaces thanks to its extremely short screwdriver handle.

Application

Multitools

All-in-one tools

Screwdriver with bit magazine LiftUp electric
Page 180



Screwdriver with bit magazine LiftUp 26one® assorted with 13 double bits in blister pack, 1/4"
Page 181



Screwdriver with bit magazine magnetic Slotted, Phillips with 6 bits, Stubby, 1/4"
Page 182



Multitool PocketStar assorted 9-pcs.
Page 183



Multitool PocketStar TORX® 8-pcs.
Page 183



Multitool PocketStar Hexagonal ball end MagicRing® 7-pcs.
Page 185



Switch cabinet key pen shape
Page 186



Nut driver insert gripper
Page 186



Interchangeable blade sets

Screwdriver with interchangeable blade set SYSTEM 6 assorted 11-pcs.
Page 187



Screwdriver with interchangeable blade set SYSTEM 6 assorted 11-pcs.
Page 187



Screwdriver with interchangeable blade set SYSTEM 6 ESD assorted 6-pcs.
Page 189



Screwdriver with interchangeable blade set SYSTEM 4 assorted 11-pcs.
Page 191



Screwdriver with interchangeable blade set SYSTEM 4 ESD assorted 11-pcs.
Page 193





Slotted, Phillips with 6 slimBits

2831 09 020

Order-No.	SB	Stack
38610		5
38612	x	1
⊖	1 x 2,5 / 1 x 3,0 / 1 x 4,0 / 1 x 5,5	
⊕	1 x PH1 / 1 x PH2	

Manufactured acc. to IEC 60900.

Pozidriv, PlusMinus/Pozidriv, slotted with 6 slimBits

2831 09 023

Order-No.	SB	Stack
41234		5
41235	x	1
⊖	1 x 2,5 / 1 x 3,5 / 1 x 5,5	
⊕	1 x PZ1 / 1 x PZ2	
⊗	1 x SL/PZ2	

Manufactured acc. to IEC 60900.

Phillips, PlusMinus/Pozidriv, slotted with 6 slimBits

2831 09 021

Order-No.	SB	Stack
38611		5
38613	x	1
⊖	1 x 3,0 / 1 x 4,0 / 1 x 5,5	
⊕	1 x PH1 / 1 x PH2	
⊗	1 x SL/PZ2	

Manufactured acc. to IEC 60900.

TORX® with 6 slimBits

2831 09 022

Order-No.	SB	Stack
41157		5
41158	x	1
⊗	1 x T8 / 1 x T9 / 1 x T10 / 1 x T15 / 1 x T20 / 1 x T25	

Manufactured acc. to IEC 60900.

**INFOBOX:
slimTECHNOLOGY**

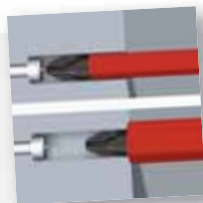







Wiha SoftFinish® electric slimFix

- Unlimited access.
- Blades up to 33 % narrower due to integrated insulation.
- Tool for spring clips (wedge-profiled output geometry).

Screwdriver with bit magazine LiftUp 26one®









assorted with 13 double bits in blister pack, 1/4" SB 3803 04 02001

Order-No.	
40907	1
 4,0 - 6,0	
 PH0 - PH3 / PH1 - PH2	
 T10 - T15 / T20 - T25 / T27 - T30	
 PZ1 - PZ2	
 #1 - #2	
 3 - 4 / 5 - 6 / 3/32 - 7/64 / 1/8 - 9/64 / 5/32 - 3/16	

LiftUp 26one® bit set refill pack 1







Mixed, 13-pcs. in blister pack 3803 04 013

Order-No.	
41385	1
 T10 - T15 / T20 - T25 / T27 - T30	
 PH1 - PH2 / PH0 - PH3	
 PZ1 - PZ2	
 #1 - #2	
 4,0 - 6,0	
 3 - 4 / 5 - 6 / 3/32 - 7/64 / 1/8 - 9/64 / 5/32 - 3/16	

LiftUp 26one® bit set refill pack 2



Mixed, 13-pcs. in blister pack 3803 04 007

Order-No.	
41384	1
 2x 4,0 - 6,0	
 2x PZ1 - PZ2	
 2x PH1 - PH2 / 2x PH0 - PH3	
 2x T10 - T15 / 1x T20 - T25 / 2x T27 - T30	

INFOBOX:
LiftUp 26one®



Most of the world's common drives in one tool!

- The LiftUp 26one® has 13 double bits; 12 in the magazine and 1 double bit in the bit holder.
- The bit magazine opens out at the press of a button, enabling the removal of the bits.
- Unlimited access to low-lying screws thanks to the automatically locking SuperSlim bit holder.
- Powerful screw fastening or loosening thanks to the large screwdriver handle.

Screwdriver with LiftUp 25 magnetic bit magazine



Mixed with 12 bits, 1/4" 3803 02 020

Order-No.	SB	Stack
38600		5
38605	x	5
⊖	1 x 4,5 / 1 x 6,5	
⊕	1 x PH1 / 1 x PH2 / 1 x PH3	
⊗	1 x PZ1 / 1 x PZ2 / 1 x PZ3	
⊙	1 x T15 / 1 x T20 / 1 x T25 / 1 x T30	

Mixed with 12 bits, 1/4" 3803 02 021

Order-No.	SB	Stack
38601		5
38606	x	5
⊖	1 x 5,5	
⊕	1 x PH2	
⊗	1 x PZ1 / 1 x PZ2 / 1 x PZ3	
⊙	1 x T15 / 1 x T20 / 1 x T25 / 1 x T30	
●	1 x 3,0 / 1 x 4,0 / 1 x 5,0	

Screwdriver with bit magazine magnetic



assorted with 8 bits, 1/4" 3809 01 01

Order-No.	SB	Stack
32901		5
33007	x	5
⊖	1 x 6,5	
⊕	1 x PH1 / 1 x PH2 / 1 x PH3	
⊗	1 x PZ2	
⊙	1 x T15 / 1 x T20 / 1 x T25	

TORX® with 8 bits, 1/4" 3809 01 02

Order-No.	SB	Stack
32902		5
33008	x	5
⊙	1 x T6 / 1 x T8 / 1 x T10 / 1 x T15 / 1 x T20 / 1 x T25 / 1 x T30 / 1 x T40	

Slotted, Phillips with 8 bits, 1/4" 3809 01 03

Order-No.	SB	Stack
32903		5
33009	x	5
⊖	1 x 5,5 / 1 x 6,5	
⊕	1 x PH1 / 3 x PH2 / 2 x PH3	

Screwdriver with bit magazine magnetic



Slotted, Phillips with 6 bits, Stubby, 1/4" 3801 01

Order-No.	SB	Stack
33736		10
33738	x	5
⊖	1 x 4,5 / 1 x 6,5 / 1 x 8,0	
⊕	1 x PH1 / 1 x PH2 / 1 x PH3	

Phillips, Pozidriv with 6 bits, Stubby, 1/4" 3801 02

Order-No.	SB	Stack
33740		10
33741	x	5
⊕	1 x PH1 / 1 x PH2 / 1 x PH3	
⊗	1 x PZ1 / 1 x PZ2 / 1 x PZ3	

TORX® with 6 bits, Stubby, 1/4" 3801 03

Order-No.	SB	Stack
33743		10
33744	x	5
⊙	1 x T10 / 1 x T15 / 1 x T20 / 1 x T25 / 1 x T30 / 1 x T40	

Slotted, Pozidriv with 6 bits, Stubby, 1/4" 3801 04

Order-No.	SB	Stack
33764		10
33746	x	5
⊖	1 x 4,5 / 1 x 6,5 / 1 x 8,0	
⊗	1 x PZ1 / 1 x PZ2 / 1 x PZ3	

Multitool PocketStar



assorted 9-pcs.

351 PG9X

Order-No.	SB	Icons
25293		5
25295	x	5
⊖	4,5	
⊕	PH2	
⊗	T10 / T15 / T20	
●	3 / 4 / 5 / 6	

Multitool PocketStar



TORX® 8-pcs.

363 P8

Order-No.	SB	Icons
23047		5
23049	x	5
⊗	T9 / T10 / T15 / T20 / T25 / T27 / T30 / T40	

Multitool Mini PocketStar



Phillips, internal hexagon, slotted 8-pcs. blister packed with hanging hole

SB 351 PM8X

Order-No.	Icons
27936	5
●	0,7 / 0,9 / 1,3 / 1,5 / 2,0
⊖	1,5 / 2,0
⊕	PH00

INFOBOX: PocketStar

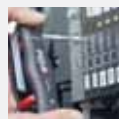

The Multitool that fits in your pocket

- Simple and easy selection of the desired key size at the touch of a button.
- Can be used as a screwdriver long handle and T-handle.
- 270° limit for safe work prevents trapped fingers.
- Covered ends on both pivot axes prevent clothing from being caught.



Multitool PocketStar



TORX® 7-pcs.

363 P7

Order-No.	SB	Icon	Quantity
23051			5
23053	x		5
T7 / T8 / T9 / T10 / T15 / T20 / T25			

Multitool PocketStar



TORX® Tamper Resistant (with hole) 7-pcs.

363TR P7

Order-No.	SB	Icon	Quantity
25128			5
25164	x		5
T7H / T8H / T9H / T10H / T15H / T20H / T25H			

Multitool PocketStar



TORX® Tamper Resistant (with hole) 8-pcs.

363TR P8

Order-No.	SB	Icon	Quantity
25130			5
25166	x		5
T9H / T10H / T15H / T20H / T25H / T27H / T30H / T40H			

INFOBOX:
TORX® tamper-resistant safety profile



- This safety profile is used to hinder unwanted access to equipment such as intercoms, thermostats and night-storage heaters.
- You can fasten the Torx® tamper resistant profile with both Torx® H screws and normal Torx® screws.

Multitool PocketStar



Hexagonal ball end MagicRing® 7-pcs.

369R P7

Order-No.	SB	Box
23031		5
23033	x	5
●	2 / 2,5 / 3 / 4 / 5 / 6 / 8	

Multitool PocketStar



Hexagon 7-pcs.

351 PK7

Order-No.	SB	Box
23035		5
23037	x	5
●	1,5 / 2 / 2,5 / 3 / 4 / 5 / 6	

Multitool PocketStar



Hexagon 7-pcs.

351 PG7

Order-No.	SB	Box
23040		5
23041	x	5
●	2 / 2,5 / 3 / 4 / 5 / 6 / 8	

INFOBOX:
Ball end hex



Wiha hexagonal ball end

- The ball end can be rotated by up to 25° in both clockwise and anti-clockwise direction.

INFOBOX:
MagicRing®

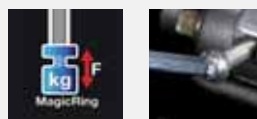

Wiha MagicRing®

- Spring steel ring reliably holds hex screws in place
- An innovation, which will benefit each user.

Switch cabinet key pen shape



1/4" in blister pack

SB 246 81

Order-No.	□	△	○	⊖	⊕	⊙	SB	📦
39076	5-8	9	3-5	7,0	PH2	T20 / T25	x	1

Nut driver insert set gripper



Hexagon with ratchet 3/8" and adapter for screwdriver in blister pack 3-pcs.

SB 246 02

Order-No.	SB	📦
20783	x	1
Nut driver insert gripper 3/8"		
Ratchet 3/8"		
Adapter 3/8"		

Switch cabinet key cross shape

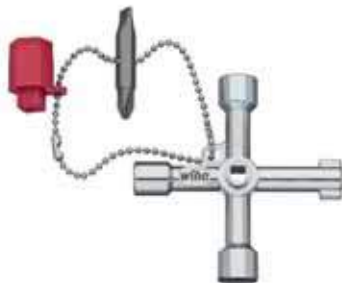

246 67

Order-No.	□	△	○	⊖	⊕	📦
36114	5-8	9	3-5	7,0	PH2	1

Nut driver insert gripper



3/8" in blister pack

SB 246 01

Order-No.	□	△	○	mm	SB	📦
20554	7-19	3/8	25,4	53,5	x	1

Screwdriver with interchangeable blade set SYSTEM 6



assorted 11-pcs.

281 B11

Order-No.



00623

1

- Screwdriver handle SoftFinish®-telescopic for SYSTEM 6 interchangeable blade
- ⊖ ⊖ 4,0 - 6,0 / 5,5 - 6,5
- ⊕ ⊕ PH1 - PH2
- ⊕ ⊕ PZ1 - PZ2
- ⊗ ⊗ T10 - T15 / T20 - T25 / T30 - T40
- ● 4 - 4 • / 5 - 5 • / 6 - 6 •

• With ball end

INFOBOX:
SYSTEM 6



Screwdriver with interchangeable blades

- Flexible, versatile interchangeable blade system in industrial quality.
- Suitable for all applications: the blades can be quickly combined, extended and exchanged.
- Press sleeve: Blade lock is released
- Desired blade length can be set (42 – 114 mm)
- Release sleeve: Blade is held in place

Screwdriver with interchangeable blade set SYSTEM 6



assorted 11-pcs.

281 T11

Order-No.



03591

1

- Screwdriver handle SoftFinish®-telescopic for SYSTEM 6 interchangeable blade
- ⊖ ⊖ 4,0 - 6,0 / 5,5 - 6,5
- ⊕ ⊕ PH1 - PH2
- ⊕ ⊕ PZ1 - PZ2
- ⊗ ⊗ T10 - T15 / T20 - T25 / T30 - T40
- ● 4 - 4 • / 5 - 5 • / 6 - 6 •

• With ball end



Screwdriver with interchangeable blade set SYSTEM 6



assorted 6-pcs.

281 T6

Order-No.  1
27715

○ Screwdriver handle SoftFinish®-telescopic for SYSTEM 6 interchangeable blade

⊖ ⊖ 3,5 - 4,5 / 4,0 - 6,0 / 5,5 - 6,5

⊕ ⊕ PH1 - PH2

● ● 5 - 5 •

• With ball end

assorted 6-pcs.

281 T6 01

Order-No.  1
32298

○ Screwdriver handle SoftFinish®-telescopic for SYSTEM 6 interchangeable blade

⊖ ⊖ 4,0 - 6,0

⊕ ⊕ PH1 - PH2

⊕ ⊕ PZ1 - PZ2

⊕ ⊕ T10 - T15 / T20 - T25

Screwdriver with interchangeable blade set SYSTEM 6



Hexagon nut driver 12-pcs.

U106 T12

Order-No.  1
27713

○ Screwdriver handle SoftFinish®-telescopic for SYSTEM 6 interchangeable blade

○ 4,0 - 150 / 4,5 - 150 / 5,0 - 150 / 5,5 - 150 / 6,0 - 150 / 7,0 - 150 / 8,0 - 150 / 9,0 - 150 / 10,0 - 150 / 11,0 - 150 / 13,0 - 150

Screwdriver with interchangeable blade set SYSTEM 6



Hexagon nut driver 8-pcs.

U106 T8

Order-No.  1
27712

○ Screwdriver handle SoftFinish®-telescopic for SYSTEM 6 interchangeable blade

○ 5,0 - 150 / 5,5 - 150 / 6,0 - 150 / 7,0 - 150 / 8,0 - 150 / 10,0 - 150 / 13,0 - 150

Screwdriver with interchangeable blade set SYSTEM 6 ESD



assorted 6-pcs.

284ESD T6 01

Order-No.	
31497	1
	Screwdriver handle SoftFinish®-telescopic ESD for SYSTEM 6 interchangeable blade
	3,5 - 4,5 / 4,0 - 6,0 / 5,5 - 6,5
	PH1 - PH2
	5 - 5 •
• With ball end	

INFOBOX:
Electrostatic
conductive ESD
tools

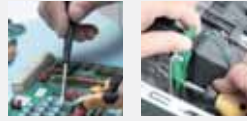

Sensitive, electronic components can be damaged even at a very low voltage.

- Dissipative tools by Wiha discharge the electrostatic energy in a controlled, safe manner.
- ESD tools meet the ESD Standard IEC 61340-5-1.
- ESD tool handles have a surface resistance of $10^6 - 10^9$ Ohm.

Screwdriver with interchangeable blade set SYSTEM 6



for SYSTEM 6 interchangeable blade

284

Order-No.					
30372	6,0	120	36		5
30404	6,0	120	36	x	5

Screwdriver handle SoftFinish®-telescopic ESD



for SYSTEM 6 interchangeable blade

284ESD

Order-No.				
31496	6,0	120	36	5
IEC 61340-5-1.				

Interchangeable blade SYSTEM 6



Slotted

284

Order-No.	⊖	⊖	⊖	⊖	mm	⬠	
27627	3,5	4,5	0,6	0,8	150	6,0	5
00629	4,0	6,0	0,8	1,0	150	6,0	5
00630	5,5	6,5	1,0	1,2	150	6,0	5

Slotted, Phillips

284

Order-No.	⊖	⊕	⊖	mm	⬠	
00665	4,0	PH1	0,8	150	6,0	5
00666	6,0	PH2	1,0	150	6,0	5
00667	6,5	PH3	1,2	150	6,0	5

Phillips

284

Order-No.	⊕	⊕	mm	⬠	
00631	PH1	PH2	150	6,0	5
27628	PH2	PH3	150	6,0	5

Pozidriv

284

Order-No.	⊕	⊕	mm	⬠	
00632	PZ1	PZ2	150	6,0	5
27629	PZ2	PZ3	150	6,0	5

TORX®

284

Order-No.	⊕	⊕	mm	⬠	
00654	T6	T8	150	6,0	5
00655	T7	T9	150	6,0	5
00656	T10	T15	150	6,0	5
00657	T20	T25	150	6,0	5
00658	T30	T40	150	6,0	5

TORX® Tamper Resistant (with hole)

284

Order-No.	⊕	⊕	mm	⬠	
27630	T6H	T8H	150	6,0	5
27631	T7H	T9H	150	6,0	5
27632	T10H	T15H	150	6,0	5
27633	T20H	T25H	150	6,0	5
27634	T30H	T40H	150	6,0	5

Ball end hex

284

Order-No.	⦿	⦿	mm	⬠	
00635	2,5	2,5	150	6,0	5
00636	3	3	150	6,0	5
00637	4•	4	150	6,0	5
00638	5•	5	150	6,0	5
00639	6•	6	150	6,0	5

• With ball end

Torq-Set®

284

Order-No.	⊕	⊕	mm	⬠	
27635	TS2	TS4	150	6,0	5
27636	TS6	TS8	150	6,0	5

Tri-Wing® 1/4"

284

Order-No.	⦿	⦿	mm	⬠	
27637	TW0	TW1	150	6,0	5
27638	TW2	TW3	150	6,0	5
27639	TW4	TW5	150	6,0	5

Interchangeable blade SYSTEM 6



1/4" square adapter for nut driver inserts

7803

Order-No.	⦿	mm	⬠	
03883	1/4	150	6,0	5

Interchangeable blade SYSTEM 6



Hex nut driver

U 106

Order-No.	⦿	mm	⬠	
08900	4,0	150	6,0	1
08901	4,5	150	6,0	1
08902	5,0	150	6,0	1
08903	5,5	150	6,0	1
08904	6,0	150	6,0	1
08905	7,0	150	6,0	1
08906	8,0	150	6,0	1
08907	9,0	150	6,0	1
08908	10,0	150	6,0	1
08909	11,0	150	6,0	1
08911	13,0	150	6,0	1

Bit holder SYSTEM 6 clamping with ball



Order-No.	⦿	mm	⬠	
03882	1/4	150	6,0	5

Screwdriver with interchangeable blade set SYSTEM 4



assorted 11-pcs.

269 T11

Order-No.	
00610	5
○	Screwdriver handle SoftFinish®-telescopic for SYSTEM 4 interchangeable blade
⊖ ⊖	1,5 - 3,0 / 2,0 - 3,5 / 2,5 - 4,0
⊕ ⊕	PH000 - PH00 / PH0 - PH1
● ●	1,3 - 1,3 / 1,5 - 1,5 / 2 - 2 • / 2,5 - 2,5 • / 3 - 3 •
• With ball end	

assorted 11-pcs.

269 T11 01

Order-No.	
27820	1
○	Screwdriver handle SoftFinish®-telescopic for SYSTEM 4 interchangeable blade
⊖ ⊖	1,5 - 3,0 / 2,0 - 3,5 / 2,5 - 4,0
⊕ ⊕	PH000 - PH00 / PH0 - PH1
⊗ ⊗	T6 - T8 / T7 - T9
● ●	1,5 - 1,5 / 2 - 2 • / 2,5 - 2,5 •
• With ball end	

Screwdriver with interchangeable blade set SYSTEM 4



slotted, Phillips, hexagon head, 4-pcs.

269 T4

Order-No.	
00613	5
○	Screwdriver handle SoftFinish®-telescopic for SYSTEM 4 interchangeable blade
⊖ ⊕	2,0 - PH00 / 3,0 - PH0 / 4,0 - PH1

Slotted, Phillips, hex 6-pcs.

269 T6

Order-No.	
00616	5
○	Screwdriver handle SoftFinish®-telescopic for SYSTEM 4 interchangeable blade
⊖ ⊖	1,5 - 3,0 / 2,0 - 3,5 / 2,5 - 4,0
⊕ ⊕	PH000 - PH00 / PH0 - PH1

Phillips, TORX® 6-pcs.

269 T6 01

Order-No.	
26121	5
○	Screwdriver handle SoftFinish®-telescopic for SYSTEM 4 interchangeable blade
⊕ ⊕	PH000 - PH00 / PH0 - PH1
⊗ ⊗	T3 - T4 / T5 - T6 / T8 - T10

INFOBOX:
SYSTEM 4



Screwdriver with interchangeable blades

- Flexible, versatile precision interchangeable blade system for delicate fastening tasks.
- Suitable for all applications: the blades can be quickly combined, extended and exchanged.
- Press sleeve: Blade lock is released
- Press and hold sleeve: Desired blade length can be set (18 – 90 mm)
- Release sleeve: Blade is held in place



Bit set SYSTEM 4 ESD



assorted 26-pcs.

7000 EB26 ESD

Order-No.



33848

1

- 1 x Screwdriver handle SoftFinish®-telescopic ESD for SYSTEM 4 interchangeable blade
- 1 x Bit holder SYSTEM 4 clamping with ball
- ⊖ 1 x 1,5 / 1 x 2,0 / 1 x 3,0 / 1 x 4,0
- ⊕ 1 x PH000 / 1 x PH00 / 1 x PH0 / 1 x PH1
- ⊗ 1 x T3 / 1 x T4 / 1 x T5 / 1 x T6 / 1 x T7 / 1 x T8 / 1 x T9 / 1 x T10
- 1 x 0,7 / 1 x 0,9 / 1 x 1,3 / 1 x 1,5 / 1 x 2,0 / 1 x 2,5 / 1 x 3,0 / 1 x 4,0

IEC 61340-5-1.

Bit set SYSTEM 4 ESD



assorted 16-pcs.

7000 EB16 ESD

Order-No.



33503

1

- 1 x Screwdriver handle SoftFinish®-telescopic ESD for SYSTEM 4 interchangeable blade
- 1 x Bit holder SYSTEM 4 clamping with ball
- ⊖ 1 x 2,0 / 1 x 3,0
- ⊕ 1 x PH000 / 1 x PH00 / 1 x PH0 / 1 x PH1
- ⊗ 1 x T3 / 1 x T4 / 1 x T5 / 1 x T6 / 1 x T8
- 1 x 0,9 / 1 x 1,3 / 1 x 1,5

DIN 3126, ISO 1173, style C 4. IEC 61340-5-1.

Screwdriver with interchangeable blade set SYSTEM 4 ESD



assorted 11-pcs.

2691 T11 ESD

Order-No.	Screwdriver handle SoftFinish®-telescopic ESD for SYSTEM 4 interchangeable blade		📦
31499			5
○	Screwdriver handle SoftFinish®-telescopic ESD for SYSTEM 4 interchangeable blade		
⊖ ⊖	1,5 - 3,0 / 2,0 - 3,5 / 2,5 - 4,0		
⊕ ⊕	PH000 - PH00 / PH0 - PH1		
⊗ ⊗	T6 - T8 / T7 - T9		
● ●	1,5 - 1,5• / 2 - 2• / 2,5 - 2,5•		

• With ball end

Screwdriver handle SoftFinish®-telescopic



○ for SYSTEM 4 interchangeable blade

2691

Order-No.	●	■	⚡	📦
30373	4,0	105	23	10

Screwdriver handle SoftFinish®-telescopic ESD



○ for SYSTEM 4 interchangeable blade

2691ESD

Order-No.	○	■	⚡	📦
31498	4,0	105	23	10

IEC 61340-5-1.

Interchangeable blade SYSTEM 4



⊖ Slotted

269

Order-No.	⊖	⊖	⊖	⊖	mm	⬮	📦
00576	1,5	3,0	0,25	0,5	120	4,0	5
00577	2,0	3,5	0,4	0,6	120	4,0	5
00578	2,5	4,0	0,4	0,8	120	4,0	5

⊖ Slotted/ Phillips

269

Order-No.	⊖	⊕	⊖	mm	⬮	📦
00601	2,0	PH00	0,4	120	4,0	5
00602	3,0	PH0	0,5	120	4,0	5
00603	4,0	PH1	0,8	120	4,0	5

⊕ Phillips

269

Order-No.	⊕	⊕	mm	⬮	📦
00579	PH000	PH00	120	4,0	5
00580	PH0	PH1	120	4,0	5

⊗ Pozidriv

269

Order-No.	⊗	⊗	mm	⬮	📦
03186	PZ0	PZ1	120	4,0	5

⬮ TORX®

269

Order-No.	⬮	⬮	mm	⬮	📦
26122	T1	T2	120	4,0	5
26123	T3	T4	120	4,0	5
26124	T5	T6	120	4,0	5
00597	T6	T8	120	4,0	5
00598	T7	T9	120	4,0	5
00599	T10	T15	120	4,0	5
00600	T15	T20	120	4,0	5

● Ball end hex

269

Order-No.	●	●	mm	⬮	📦
00582	1,3•	1,3	120	4,0	5
00583	1,5•	1,5	120	4,0	5
00584	2•	2	120	4,0	5
00585	2,5•	2,5	120	4,0	5
00586	3•	3	120	4,0	5
00587	4•	4	120	4,0	5

• With ball end



L-keys

Difficult to access - easily solved.

Wiha L-keys are essential for all users who are faced with a screw fastening task in difficult work conditions. For difficult-to-access screws Wiha L-keys with a shortened L-key arm prove themselves to be ideal. The risk of injury is significantly reduced as the hand-working space is increased by over 30%.

Wiha ball-end tools enable fastening at angles of up to 25° per side. The risk of an accident is reduced since the tool does not slip out of the screw. Screws made of steel and non-magnetic materials are securely held in any position with the Wiha MagicRing and MagicSpring.

Application L-keys

L-key holders

L-key set in ErgoStar holder
hexagonal ball
Magicring® 9-pcs. in
flourescent colour
 Page 196



L-key set in ErgoStar holder
Hexagonal ball end
MagicRing® matt
chrome-plated 9-pcs.
 Page 197



L-key set in ProStar holder
Matt chrome-plated
hexagonal ball end with
short shaft, 9-pcs.
 Page 198



L-key set in ProStar holder
Hexagonal ball end matt
chrome-plated 9-pcs.
 Page 198



L-key set in Compact holder
Hexagonal ball end,
9-pcs., short, matt
chrome-plated
 Page 199



L-key set in ErgoStar holder
TORX® ball end, 13-pcs.,
black oxidised
 Page 202



L-key set in ProStar holder
TORX® titanium silver
13-pcs.
 Page 203



L-key set in ProStar holder
TORX®, 13-pcs., black
oxidised
 Page 203



L-key set in Classic holder
holder
TORX PLUS®
MagicSpring®, 8-pcs.,
medium-length, black
oxidised
 Page 204



L-key with T-handle
ComfortGrip
Hexagonal ball end with
side drive, matt chrome-
plated
 Page 204



L-key with key handle
TORX®, black oxidised
 Page 206



L-key with flag handle
TORX®, black oxidised
 Page 206



L-key set in ErgoStar holder



hexagonal ball MagicRing® 9-pcs. in fluorescent colour

369RF

Order-No.	SB	Icons
41979		5
41980	x	5
●		1,5 / 2 / 2,5
●		3 / 4 / 5 / 6 / 8 / 10

MagicRing® from size 3 mm. Based on ISO 2936L.

L-key set in ErgoStar holder



hexagonal ball end, 9-pcs. in fluorescent colour

369F

Order-No.	SB	Icons
41483		5
41484	x	5
●		1,5 / 2 / 2,5 / 3 / 4 / 5 / 6 / 8 / 10

INFOBOX:
Tools in fluorescent colour



- Coloured bits and ErgoStar with coloured L-keys light up under a UV light.
- Ensuring misplaced tools are quickly and easily found again.
- The Wiha flashlight with a UV light makes the perfect complement to coloured fluorescent tools.



INFOBOX:
ErgoStar

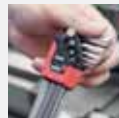

The right L-key after just one turn.

- One turn of any L-key and all L-keys are ready for removal.
- Solid stopping point for fixing L-keys in the holder.
- Innovative clamping ensures L-keys are held firmly in both a closed and open position.
- Compact design saves space on the work bench or in the toolbox.
- Wall bracket for practical storage of the ErgoStar holder in the workshop.

L-key set in ErgoStar holder



Hexagonal ball end MagicRing® matt chrome-plated 9-pcs. 369R

Order-No.	SB	Box
37351		5
37352	x	5
● 1,5 / 2 / 2,5		
● 3 / 4 / 5 / 6 / 8 / 10		

MagicRing® from size 3 mm. Based on ISO 2936L.

L-key set in ErgoStar holder



Hexagonal ball end MagicRing® matt chrome-plated, inch design 13-pcs. 369RZ

Order-No.	SB	Box
36521		5
36522	x	5
● 0.05 / 1/16 / 5/64 / 3/32 / 7/64		
● 1/8 / 9/64 / 5/32 / 3/16 / 7/32 / 1/4 / 5/16 / 3/8		

MagicRing® from 1/8" Based on ASME B18.3.

Wall bracket



for L-key in ErgoStar holder

Order-No.	Box
39205	5

INFOBOX:
MagicRing®

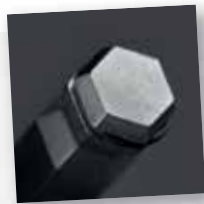

Wiha MagicRing®

- Spring steel ring reliably holds hex screws in place
- An innovation, which will benefit each user.

INFOBOX:
Ball end hex

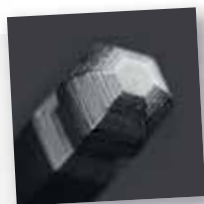

Wiha hexagonal ball end

- The ball end can be rotated by up to 25° in both clockwise and anti-clockwise direction.

L-key set in ProStar holder



Matt chrome-plated hexagonal ball end with short shaft, 9-pcs.

369T

Order-No.	SB	Icon	Quantity
35480			5
35481	x		5
● 1,5 / 2 / 2,5 / 3 / 4 / 5 / 6 / 8 / 10			

Based on ISO 2936L.

L-key set in ProStar holder



Hexagonal ball end in inch design, 13-pcs., black oxidised

369ZB

Order-No.	SB	Icon	Quantity
24189			5
24851	x		5
● 0.05 / 1/16 / 5/64 / 3/32 / 7/64 / 1/8 / 9/64 / 5/32 / 3/16 / 7/32 / 1/4 / 5/16 / 3/8			

Based on ASME B18.3.

L-key set in ProStar holder



Hexagonal ball end matt chrome-plated 9-pcs.

369

Order-No.	SB	Icon	Quantity
07185			5
07192	x		5
● 1,5 / 2 / 2,5 / 3 / 4 / 5 / 6 / 8 / 10			

Based on ISO 2936L.

L-key set in Compact holder



Hexagonal ball end matt chrome-plated 11-pcs.

369

Order-No.	SB	Icon	Quantity
36453			5
36454	x		5
● 1,5 / 2 / 2,5 / 3 / 4 / 5 / 6 / 7 / 8 / 9 / 10			

Including 7 mm and 9 mm special sizes. Based on ISO 2936L.

INFOBOX:
L-key with short shaft



Especially for hard-to-reach screws and confined spaces

Improved accessibility thanks to a 60% reduction in length of the short L-key side.

- Increase in the hand working space of over 30% and thus a reduction of the risk of injury to the knuckles and fingertips thanks to a 95° bend of the L-key.
- Ball end geometry enables fastening at an angle of up to 25°.

L-key set in Compact holder



Hexagonal ball end matt chrome-plated 9-pcs. 369

Order-No.	SB	Box
01418		5
02292	x	5
●	1,5 / 2 / 2,5 / 3 / 4 / 5 / 6 / 8 / 10	

Based on ISO 2936L.

L-key set in Classic holder

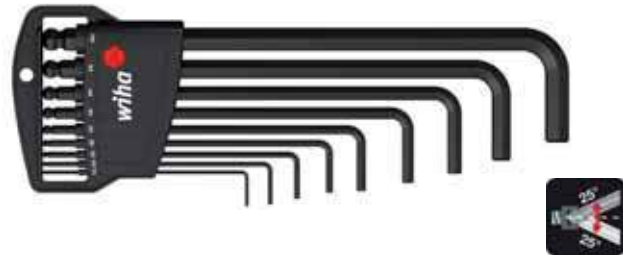

Hexagonal ball end, 9-pcs., black oxidised 369B

Order-No.	SB	Box
03879		5
03992	x	10
●	1,5 / 2 / 2,5 / 3 / 4 / 5 / 6 / 8 / 10	

Based on ISO 2936L.

L-key set in Compact holder



Hexagonal ball end, 9-pcs., short, matt chrome-plated 369K

Order-No.	SB	Box
40410		10
40411	x	5
●	1,5 / 2 / 2,5 / 3 / 4 / 5 / 6 / 8 / 10	

Based on ISO 2936L.

L-key set in Classic holder

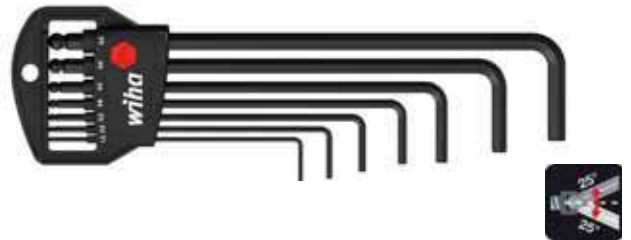

Hexagonal ball end, 7-pcs., black oxidised 369B

Order-No.	SB	Box
03878		5
03991	x	10
●	1,5 / 2 / 2,5 / 3 / 4 / 5 / 6	

Based on ISO 2936L.

L-key set in Classic holder

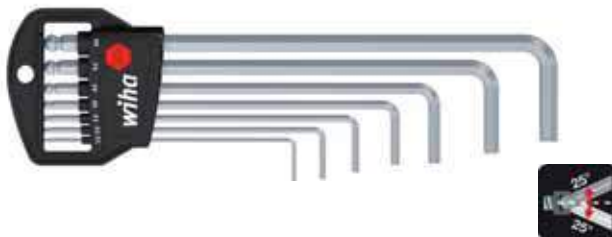

Hexagonal ball end matt chrome-plated 7-pcs. 369

Order-No.	SB	Box
01416		5
03723	x	10
●	1,5 / 2 / 2,5 / 3 / 4 / 5 / 6	

Based on ISO 2936L.

L-key set in Classic holder

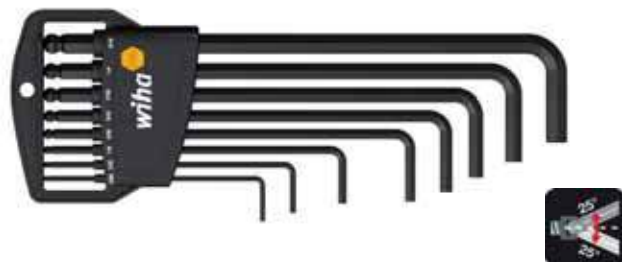

Hexagonal ball end, 8-pcs. in inch design, black oxidised 369ZB

Order-No.	SB	Box
01420		5
02939	x	10
●	5/64 / 3/32 / 1/8 / 5/32 / 3/16 / 7/32 / 1/4 / 5/16	

Based on ASME B18.3.

L-key set in Classic holder

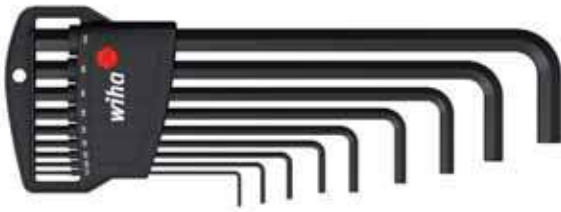

Hex, 9-pcs., black oxidised

352 H9B

Order-No.		
06386		5
● 1,5 / 2 / 2,5 / 3 / 4 / 5 / 6 / 8 / 10		

Based on ISO 2936L.

L-key set in Classic holder



Hex, 9-pcs., black oxidised

350 H9

Order-No.		
06379		10
● 1,5 / 2 / 2,5 / 3 / 4 / 5 / 6 / 8 / 10		

ISO 2936K.

L-key set in Classic holder

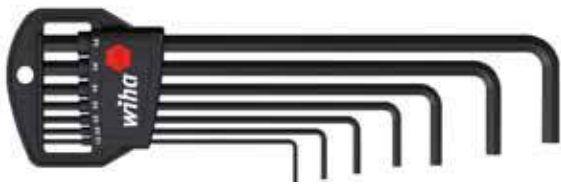

Hex, 7-pcs., black oxidised

352 H7B

Order-No.		
06384		5
● 1,5 / 2 / 2,5 / 3 / 4 / 5 / 6		

Based on ISO 2936L.

L-key set in Classic holder



Hex, 7-pcs., black oxidised

350 H7

Order-No.		
06378		10
● 1,5 / 2 / 2,5 / 3 / 4 / 5 / 6		

ISO 2936K.

L-key set in Classic holder



Hex, 5-pcs., black oxidised

352 HM5B

Order-No.		
06382		10
● 0,7 / 0,9 / 1,3 / 1,5 / 2		

Based on ISO 2936L.

L-key set in ErgoStar holder



TORX® MagicSpring®, 13-pcs., black oxidised

366R

Order-No.	SB	Icon
36503		5
36504	x	5
☛ T5		
T6 / T7 / T8 / T9 / T10 /		
☛ T15 / T20 / T25 / T27 /		
T30 / T40 / T45		

MagicSpring® from size T6

L-key set in Classic holder



TORX® MagicSpring®, 8-pcs., black oxidised

366R

Order-No.	SB	Icon
34740		5
34741	x	10
☛ T9 / T10 / T15 / T20 / T25 /		
T27 / T30 / T40		

L-key set in Classic holder

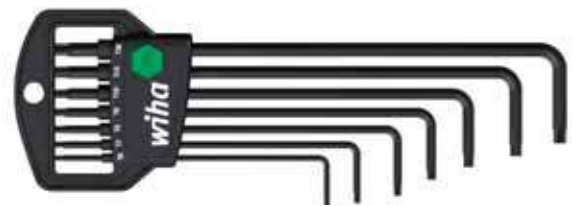

TORX® MagicSpring®, 7-pcs., black oxidised

366R

Order-No.	SB	Icon
33753		5
33754	x	5
☛ T6 / T7 / T8 / T9 / T10 /		
T15 / T20		

INFOBOX:
MagicSpring®



Wiha TORX® MagicSpring®

- TORX® and TORX PLUS® screws are held securely in place.
- An innovation, which will benefit each user.

L-key set in ErgoStar holder



TORX® ball end, 13-pcs., black oxidised

366BE

Order-No.	SB	Box
36487		5
36486	x	5
● T5 / T6 / T7 / T8 ● T9 / T10 / T15 / T20 / T25 / ● T27 / T30 / T40 / T45		

TORX® ball end from size T9

L-key set in Classic holder

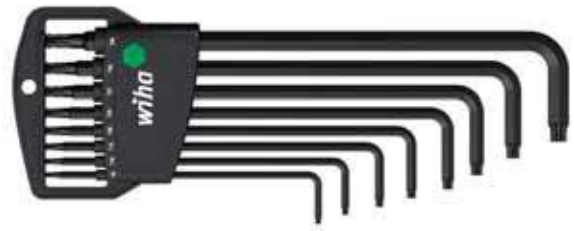

TORX® ball end, 8-pcs., black oxidised

366BE

Order-No.	SB	Box
32394		5
32395	x	10
● T9 / T10 / T15 / T20 / T25 / ● T27 / T30 / T40		

L-key set in ProStar holder



Stubby TORX® ball end, 13-pcs. in titanium silver

366BET

Order-No.	SB	Box
40979		5
40980	x	1
● T5 / T6 / T7 / T8 / T9 / ● T10 / T15 / T20 / T25 / ● T27 / T30 / T40 / T45		

TORX® ball end from size T9

INFOBOX:
TORX® ball end



Wiha TORX® ball end

With optimised TORX® ball end geometry

- Increased strength thanks to the special cold forming on a system developed by Wiha especially for this purpose.
- Allows fastening and unfastening at angles up to 25°.
- Simple insertion of the tool/bit and fastening/unfastening, especially in hard-to-reach positions.
- Broad product range: As an L-key, as a bit and as a SoftFinish® screwdriver.

L-key set in ProStar holder



TORX® titanium silver 13-pcs.

366TS

Order-No.	SB	Box
39104		5
39105	x	5
T5 / T6 / T7 / T8 / T9 / T10 / T15 / T20 / T25 / T27 / T30 / T40 / T45		

L-key set in Classic holder

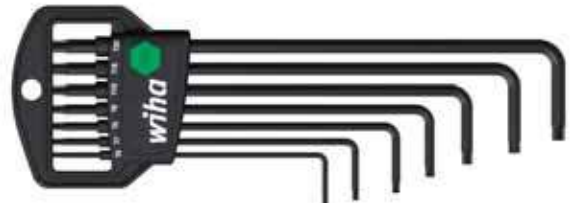

TORX®, 7-pcs., black oxidised

366 H7

Order-No.	SB	Box
34738		5
T6 / T7 / T8 / T9 / T10 / T15 / T20		

L-key set in ProStar holder



TORX®, 13-pcs., black oxidised

366

Order-No.	SB	Box
24312		5
24852	x	5
T5 / T6 / T7 / T8 / T9 / T10 / T15 / T20 / T25 / T27 / T30 / T40 / T50		

L-key set in Classic holder



TORX®, 8-pcs., short, black oxidised

363

Order-No.	SB	Box
36461		5
36457	x	10
T9 / T10 / T15 / T20 / T25 / T27 / T30 / T40		

L-key set in Classic holder



TORX®, 8-pcs., black oxidised

366

Order-No.	SB	Box
34736		5
34737	x	10
T9 / T10 / T15 / T20 / T25 / T27 / T30 / T40		

L-key set in Classic holder



TORX®, 7-pcs., short, black oxidised

363 H7

Order-No.	SB	Box
36460		5
T6 / T7 / T8 / T9 / T10 / T15 / T20		

L-key set in Classic holder



TORX PLUS® MagicSpring®, 8-pcs., medium-length, black oxidised

371RIP H8

Order-No.		
34742		5

9IP / 10IP / 15IP / 20IP / 25IP / 27IP / 30IP / 40IP

TORX PLUS® keys cannot be used with TORX® screws.

L-key set in Classic holder



TORX® Tamper Resistant (with hole), 8-pcs., black oxidised

363TR

Order-No.		
36462		5
36458	x	10

T9H / T10H / T15H / T20H / T25H / T27H / T30H / T40H

L-key set in Classic holder



TORX PLUS® MagicSpring®, 7 pcs., medium-length, black oxidised

371RIP HM7

Order-No.		
29208		5

6IP / 7IP / 8IP / 9IP / 10IP / 15IP / 20IP

TORX PLUS® keys cannot be used with TORX® screws.

L-key with T-handle set ComfortGrip



Hexagon with side drive, matt chrome-plated 6-pcs.

334DS K6

Order-No.		
26247		1

2,5 / 3 / 4 / 5 / 6 / 8

L-key set in Classic holder



TORX PLUS®, 8-pcs. in black oxidised

361IP

Order-No.		
36459		5
36456	x	10

9IP / 10IP / 15IP / 20IP / 25IP / 27IP / 30IP / 40IP

TORX PLUS® keys cannot be used with TORX® screws.

L-key with T-handle set ComfortGrip



TORX® with side drive, matt chrome-plated 6-pcs.

364DS K6

Order-No.		
26248		1



T10 / T15 / T20 / T25 / T30 / T40

L-key set



Short TORX® in work bench stand, 9-pcs., black oxidised

363 VB



Order-No.		
01326		1
<p> T10 / T15 / T20 / T25 / T30 / T40 / T50 / T55 / T60</p>		

L-key with T-handle set



Hex in work bench stand, 7-pcs., brilliant nickel-plated

334 VB

Order-No.	
00953	1
<p> 2 x 100 / 2,5 x 100 / 3 x 100 / 4 x 150 / 5 x 150 / 6 x 200 / 8 x 200</p>	



L-key with T-handle set



Hexagon MagicRing® brilliant nickel-plated in work bench stand 6-pcs.



334R VB



Order-No.	
22096	1
<p> 3 x 100 / 4 x 150 / 5 x 150 / 6 x 150 / 8 x 200 / 10 x 200</p>	

L-key with T-handle set



Short TORX® in work bench stand, 7-pcs., matt chrome-plated

364 VB

Order-No.	
01348	1
<p> T10 x 100 / T15 x 100 / T20 x 100 / T25 x 100 / T30 x 100 / T40 x 200 / T50 x 250</p>	

L-key with key handle set



TORX® in work bench stand, 7 pcs., black oxidised

365 VB

Order-No.



25624

1



T6 x 35 / T7 x 35 / T8 x 40 / T9 x 40 / T10 x 40 /
T15 x 45 / T20 x 45

L-key with flag handle set



TORX® in work bench stand, 7 pcs., black oxidised

370 VB

Order-No.



25625

1



T6 x 35 / T7 x 35 / T8 x 40 / T9 x 40 / T10 x 40 /
T15 x 45 / T20 x 45

L-key with key handle set



TORX PLUS® in work bench stand, 7-pcs., black oxidised

365IP VB

Order-No.



26261

1



6IP x 35 / 7IP x 35 / 8IP x 40 / 9IP x 40 / 10IP x 40 /
15IP x 45 / 20IP x 45

L-keys



Hexagonal ball end MagicRing® matt chrome-plated

369R

Order-No.	●	↔	└┘	📦
20549	3	128	23	10
20550	4	142	29	10
20570	5	163	33	10
20551	6	184	38	10
20552	8	206	44	10
20553	10	231	50	5

Based on ISO 2936L.

L-keys



Hexagonal ball end MagicRing®, inch design matt chrome-plated

369R Zoll

Order-No.	●	↔	└┘	mm	📦
24302	1/8	121	23	3,17	10
24304	9/64	136	27	3,57	10
24303	5/32	148	29	3,96	10
24305	3/16	163	33	4,76	10
24306	7/32	176	36	5,55	10
24307	1/4	191	38	6,35	10
24308	5/16	210	43	7,93	10
24341	3/8	232	49	9,52	10

Based on ASME B18.3.

L-keys



hexagonal ball MagicRing® in fluorescent colour

369RF

Order-No.	●	↔	└┘	◀C	📦
41973	3	128	23	Orange	10
41974	4	142	29	Purple	10
41975	5	163	33	Dark green	10
41976	6	184	38	Red	10
41977	8	206	44	Dark blue	10
41978	10	231	50	Anthracite	10

Based on ISO 2936L.

L-keys



hexagonal ball in fluorescent colour

369F

Order-No.	●	↔	└┘	◀C	📦
41894	1,5	91	15	Yellow	10
41895	2	101	18	Light blue	10
41896	2,5	113	20	Light green	10
41897	3	128	23	Orange	10
41898	4	142	29	Purple	10
41899	5	163	33	Dark green	10
41900	6	184	38	Red	10
41901	8	206	44	Dark blue	10
41902	10	231	50	Anthracite	5

L-keys



Hexagonal ball end with short side, matt chrome-plated

369T

Order-No.	●	↔	└┘	📦
35482	1,5	91	5,5	10
35483	2	101	9	10
35484	2,5	113	9,5	10
35485	3	128	11	10
35486	4	142	13	10
35487	5	163	15	10
35488	6	184	18	10
35489	8	206	22	10
35490	10	231	28	5

Based on ISO 2936L.

L-keys



Hexagonal ball end, short

369K

Order-No.	●	↔	└┘	📦
40401	1,5	46	15	10
40402	2	51	18	10
40403	2,5	57	20	10
40404	3	64	23	10
40405	4	72	29	10
40406	5	83	33	10
40407	6	94	38	10
40408	8	105	44	10
40409	10	119	50	10

As per ISO 2936K.

L-keys



Hexagonal ball end matt chrome-plated

369

Order-No.	●	↔	└┘	📦
01392	1,5	91	15	10
01393	2	101	18	10
01395	2,5	113	20	10
01396	3	128	23	10
01398	4	142	29	10
01400	5	163	33	10
01402	6	184	38	10
07922	7	195	39	5
01404	8	206	44	10
36452	9	217	47	5
01406	10	231	50	5
01408	12	259	57	5

Based on ISO 2936L.

L-keys



Matt chrome-plated hexagonal ball end in inch design

369Z

Order-No.	●	↔	└┘	mm	📦
29471	0.05	72	13	1,27	10
29472	1/16	80	15	1,59	10
29474	5/64	88	18	1,98	10
29473	3/32	101	20	2,38	10
29475	7/64	111	21	2,78	10

Based on ASME B18.3.

L-keys



hexagonal ball end, black oxidised

369B

Order-No.	●	↔	└┘	⊞
01391	1,3	74	14	10
05638	1,5	91	15	10
03868	2	101	18	10
03869	2,5	113	20	10
03870	3	128	23	10
03871	4	142	29	10
03872	5	163	33	10
03873	6	184	38	10
03874	8	206	44	10
03875	10	231	50	10
03876	12	259	57	10

Based on ISO 2936L.

L-keys



Hexagonal ball end in inch design, black oxidised

369 Zoll B

Order-No.	●	↔	└┘	mm	⊞
01422	0,05	72	13	1,27	10
01423	1/16	80	15	1,59	10
01431	5/64	88	18	1,98	10
01427	3/32	101	20	2,38	10
01433	7/64	111	21	2,78	10
01425	1/8	121	23	3,18	10
01434	9/64	136	27	3,57	10
01430	5/32	148	29	3,97	10
01426	3/16	163	33	4,76	10
01432	7/32	176	36	5,56	10
01424	1/4	191	38	6,35	10
01429	5/16	210	43	7,94	10
01428	3/8	232	49	9,53	5

Based on ASME B18.3.

L-keys



Hex , black oxidised

352B

Order-No.	●	↔	└┘	⊞
06358	0,7	67	6	5
06359	0,9	70	9	5
06360	1,3	80	13	5
06059	1,5	91	15	10
06361	2	101	18	10
06362	2,5	113	20	10
06363	3	128	23	10
06364	4	142	29	10
06365	5	163	33	10
06366	6	184	38	10
06367	7	194	41	10
06368	8	206	44	10
06369	10	231	50	5
06370	12	259	57	5
06371	14	291	70	5

Based on ISO 2936L.

L-keys



Hex, short, black oxidised

350

Order-No.	●	↔	└┘	📦
06218	1,3	41	13	10
01121	1,5	46	15	10
01122	2	51	18	10
01123	2,5	57	20	10
01124	3	64	23	10
01126	4	72	29	10
01128	5	83	33	10
01130	6	94	38	10
01131	7	99	41	10
01132	8	105	44	10
01133	9	112	47	5
01134	10	119	50	5
01135	11	126	53	5
01136	12	134	57	5
01137	14	151	70	5
01138	17	173	80	5
01139	19	195	89	5
01140	22	217	102	1
01141	24	241	114	1
01142	27	271	127	1
01143	32	339	157	1

ISO 2936K.

L-keys



TORX® MagicSpring®, black oxidised

366R

Order-No.	⊕	↔	└┘	⬠	📦
31233	T6	80	15	1/16	10
31234	T7	88	18	5/64	10
31235	T8	101	20	3/32	10
31236	T9	111	21	7/64	10
31237	T10	121	23	1/8	10
31238	T15	136	27	9/64	10
31239	T20	148	29	5/32	10
31240	T25	163	33	3/16	10
31241	T27	176	36	7/32	10
31242	T30	191	38	1/4	10
31243	T40	210	43	5/16	10
31244	T45	232	49	3/8	10

L-keys



TORX® ball end, black oxidised

366BE

Order-No.	⊕	↔	└┘	⬠	📦
32386	T9	111	21	7/64	10
32387	T10	121	23	1/8	10
32388	T15	136	27	9/64	10
32389	T20	148	29	5/32	10
32390	T25	163	33	3/16	10
32391	T27	176	36	7/32	10
32392	T30	191	38	1/4	10
32393	T40	210	43	5/16	10
33749	T45	232	49	3/8	10
33750	T50	232	49	3/8	10

L-keys



TORX® ball end with short handle, titanium silver

366BET

Order-No.	⊕	↔	└	⦿	📦
40966	T5	72	6,5	0,05	10
40967	T6	80	6,9	1/16	10
40968	T7	89	8,9	5/64	10
40969	T8	101	10,4	3/32	10
40970	T9	111	11,8	7/64	10
40971	T10	122	12,0	1/8	10
40972	T15	136	12,5	9/64	10
40973	T20	149	13,3	5/32	10
40974	T25	164,5	16,2	3/16	10
40975	T27	176	18,0	7/32	10
40976	T30	191	19,2	1/4	10
40977	T40	210	24,1	5/16	10
40978	T45	232	29,5	3/8	10

TORX® ball end from size T9

L-keys



TORX® titanium silver

366 TS

Order-No.	⊕	↔	└	⦿	📦
39106	T5	72	13	0,05	10
39107	T6	80	15	1/16	10
39108	T7	88	18	5/64	10
39109	T8	101	20	3/32	10
39110	T9	111	21	7/64	10
39111	T10	121	23	1/8	10
39112	T15	136	27	9/64	10
39113	T20	148	29	5/32	10
39114	T25	163	33	3/16	10
39115	T27	176	36	7/32	10
39116	T30	191	38	1/4	10
39117	T40	210	43	5/16	10
39118	T45	232	49	3/8	10

L-keys



TORX®, black oxidised

366

Order-No.	⊕	↔	└	⦿	📦
24313	T5	72	13	0,05	10
24314	T6	80	15	1/16	10
24315	T7	88	18	5/64	10
24316	T8	101	20	3/32	10
24317	T9	111	21	7/64	10
24318	T10	121	23	1/8	10
24319	T15	136	27	9/64	10
24320	T20	148	29	5/32	10
24321	T25	163	33	3/16	10
24322	T27	176	36	7/32	10
24323	T30	191	38	1/4	10
24324	T40	210	43	5/16	10
24325	T50	232	49	3/8	10

L-keys



TORX®, short, black oxidised

363

Order-No.	⊕	↔	└	⦿	📦
03764	T5	39	18	2,5	10
01310	T6	41	18	2,5	10
01311	T7	44	18	2,5	10
01312	T8	47	18	2,5	10
01313	T9	51	19	3,0	10
01314	T10	54	20	3,0	10
01315	T15	57	22	3,5	10
01316	T20	62	23	4,0	10
01317	T25	67	25	4,5	10
01318	T27	72	27	5,5	10
01319	T30	79	30	6,0	10
01320	T40	86	33	7,0	10
01321	T45	90	36	8,0	10
01322	T50	104	41	9,0	10
01323	T55	120	47	12,0	10
01324	T60	134	52	14,0	10

L-keys



TORX PLUS® MagicSpring®, medium-length, black oxidised

371RIP

Order-No.	●	↔	└┘	●	📦
29197	6IP	65	16	1/16	10
29198	7IP	71	18	5/64	10
29199	8IP	77	20	3/32	10
29200	9IP	83	22	7/64	10
29201	10IP	90	24	1/8	10
29202	15IP	97	26	9/64	10
29203	20IP	104	29	5/32	10
29204	25IP	112	33	3/16	10
29205	27IP	122	36	7/32	10
29206	30IP	132	40	1/4	10
29207	40IP	143	44	5/16	10

L-keys



TORX® Tamper Resistant (with hole), short, black oxidised

363TR

Order-No.	⊕	↔	└┘	●	📦
24107	T8H	47	18	2,5	10
24109	T9H	51	19	3,0	10
24111	T10H	54	20	3,0	10
24113	T15H	57	22	3,5	10
24115	T20H	62	23	4,0	10
24117	T25H	67	25	4,5	10
24119	T27H	72	27	5,5	10
24121	T30H	79	30	6,0	10
24123	T40H	86	33	7,0	10

L-keys



TORX PLUS®, short, black oxidised

361IP

Order-No.	●	↔	└┘	●	📦
24513	6IP	41	18	2,5	10
24515	7IP	44	18	2,5	10
24517	8IP	47	18	2,5	10
24519	9IP	51	19	3,0	10
24521	10IP	54	20	3,0	10
24523	15IP	58	22	3,5	10
24525	20IP	62	23	4,0	10
24527	25IP	67	25	4,5	10
24529	27IP	73	27	5,5	10
24531	30IP	79	30	6,0	10
24533	40IP	88	33	7,0	10

L-key with T-handle ComfortGrip



Hexagon MagicRing® with side drive, matt chrome-plated

334DSR

Order-No.	●	↔	↔	↔	↔	📦
26135	3	100	13	80	26	10
26136	4	150	13	80	26	10
26137	5	150	17	100	32	10
26138	6	150	17	100	32	10
26139	8	200	17	100	32	10
26140	10	200	22	120	38	5

L-key with T-handle ComfortGrip



Hex with side drive, matt chrome-plated

334DS

Order-No.	●	↔	↔	↔	↔	📦
26164	2	100	13	80	26	10
26165	2,5	100	13	80	26	10
26166	3	100	13	80	26	10
26167	4	150	13	80	26	10
26168	5	150	17	100	32	10
26169	6	150	17	100	32	10
26170	8	200	17	100	32	10
26171	10	200	22	120	38	5

L-key with T-handle ComfortGrip



Hexagonal ball end with side drive, matt chrome-plated

540DS

Order-No.	●	↔	↔	↔	↔	📦
28372	3	150	13	80	26	10
28373	4	150	13	80	26	10
28374	5	150	17	100	32	10
28375	6	150	17	100	32	10
28376	8	200	17	100	32	10
28377	10	200	22	120	38	5

L-key with T-handle ComfortGrip

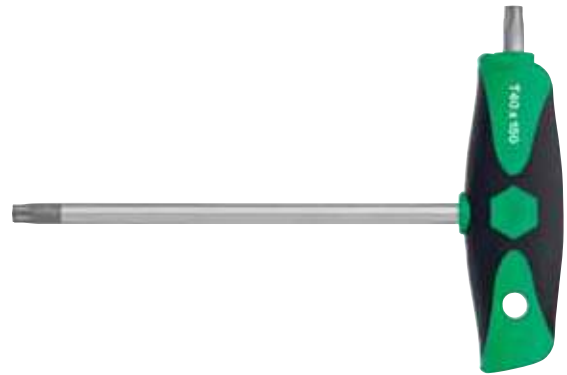

TORX® with side drive, matt chrome-plated

364DS

Order-No.	●	↔	↔	↔	↔	📦
26172	T10	100	13	80	26	10
26173	T15	100	13	80	26	10
26174	T20	100	17	100	32	10
26175	T25	150	17	100	32	10
26176	T27	150	17	100	32	10
26177	T30	150	17	100	32	10
26178	T40	150	17	100	32	10

L-key with T-handle



Hexagon MagicRing® brilliant nickel-plated

334R

Order-No.	●	⊚	⊚	⊚	⊚	⊚	⊚
22168	3	100	126	80	26	10	
22170	4	150	176	80	26	10	
22172	5	150	182	100	32	10	
22174	6	150	182	100	32	10	
21960	8	200	232	100	32	10	
21962	10	200	238	120	38	10	

L-key with T-handle



Hexagonal ball end brilliant nickel-plated

540

Order-No.	●	⊚	⊚	⊚	⊚	⊚	⊚
04111	4	150	176	80	26	10	
04108	5	150	182	100	32	10	
04105	6	150	182	100	32	10	
04099	8	200	238	100	32	10	
04096	10	200	238	120	38	10	

L-key with T-handle



Hexagon brilliant nickel-plated

334

Order-No.	●	⊚	⊚	⊚	⊚	⊚	⊚
00904	2	100	-	126	80	26	10
00905	2	200	-	226	80	26	10
00906	2,5	100	-	126	80	26	10
00907	2,5	200	-	226	80	26	10
00908	3	100	-	126	80	26	10
00909	3	150	-	176	80	26	10
00910	3	200	-	226	80	26	10
00911	3•	350	5+	382	100	32	10
00912	4	100	-	126	80	26	10
00913	4	150	-	176	80	26	10
00914	4	200	-	226	80	26	10
00915	4•	350	5+	382	100	32	10
00916	5	100	-	132	100	32	10
00917	5	150	-	182	100	32	10
00918	5	200	-	232	100	32	10
00919	5	350	-	382	100	32	10
00921	6	100	-	132	100	32	10
00922	6	150	-	182	100	32	10
00923	6	200	-	232	100	32	10
00924	6	350	-	382	100	32	10
00926	7	200	-	232	100	32	10
00928	8	100	-	132	100	32	10
00929	8	150	-	182	100	32	10
00930	8	200	-	232	100	32	10
00931	8	350	-	382	100	32	10
00933	10	100	-	138	120	38	10
00934	10	200	-	238	120	38	10
00937	12	200	-	238	120	38	5

• Overlength with reinforced blade.

Nut driver with T-handle



Hexagon brilliant nickel-plated

336

Order-No.	⌀	↔	↔	↔	↔	
00965	5,5	125	157	100	32	10
00966	6	125	157	100	32	10
00967	6	200	232	100	32	10
00968	7	125	157	100	32	10
00969	7	200	232	100	32	10
00970	7	350	382	100	32	10
00971	8	125	157	100	32	10
00972	8	200	232	100	32	10
00973	8	350	382	100	32	10
00974	9	125	157	100	32	10
00975	9	200	232	100	32	10
00977	10	125	157	100	32	10
00978	10	200	232	100	32	10
00979	10	230	262	100	32	10
00980	10	350	382	100	32	10
00982	11	125	157	100	32	10
00983	11	230	262	100	32	5
00985	12	125	157	100	32	10
00986	12	230	262	100	32	5
00988	13	125	157	100	32	10
00989	13	230	262	100	32	10
00990	13	350	382	100	32	10
00991	14	125	157	100	32	5
00993	15	125	157	100	32	5
00994	16	125	157	100	32	5
00995	17	125	157	100	32	5

Nut driver with T-handle



Square nickel-plated

338

Order-No.	⌀	↔	↔	↔	↔	
01005	6	125	157	100	32	10
01006	8	125	157	100	32	10
01007	10	125	157	100	32	10
01008	12	125	157	100	32	10



L-key with T-handle



Hex, inch design brilliant nickel-plated

334 Zoll

Order-No.	●	↔	↔	—	—	mm	📦
02802	3/32	150	176	80	26	2,38	10
02803	7/64	150	176	80	26	2,78	10
02804	1/8	150	176	80	26	3,18	10
02805	9/64	150	176	80	26	3,57	10
02806	5/32	150	176	80	26	3,97	10
02807	3/16	150	182	100	32	4,76	10
02808	7/32	150	182	100	32	5,56	10
02809	1/4	150	182	100	32	6,35	10
02810	5/16	150	182	100	32	7,94	10
02811	3/8	150	188	120	38	9,53	10

L-key with T-handle electric



Hex

334N

Order-No.	●	↔	↔	—	—	📦
27928	4	150	176	80	26	10
27929	5	150	182	100	32	10
27930	6	150	182	100	32	10
27931	8	150	182	100	32	10

Manufactured acc. to IEC 60900.

Nut driver with T-handle



Hex, inch design brilliant nickel-plated

336 Zoll

Order-No.	○	↔	↔	—	—	mm	📦
02819	3/16	150	182	100	32	4,76	10
02820	1/4	150	182	100	32	6,35	10
02821	5/16	150	182	100	32	7,94	10
02822	3/8	150	182	100	32	9,53	10
02823	7/16	150	182	100	32	11,11	10
02824	1/2	150	182	100	32	12,70	10

Nut driver with T-handle electric



Hex

336N

Order-No.	○	↔	↔	—	—	📦
27932	8	200	232	100	32	10
27933	10	230	262	100	32	10
27934	13	230	262	100	32	10
27935	17	230	268	120	38	10

Manufactured acc. to IEC 60900.

L-key with T-handle



TORX® matt chrome-plated

364

Order-No.	●	⇄	●	⇄	⇄	⇄	📦
01328	T9	100	4,0	126	80	26	10
01329	T10	100	4,0	126	80	26	10
01330	T15	100	4,0	126	80	26	10
01331	T15	200	5,5	226	80	26	10
01332	T20	100	4,0	132	100	32	10
01333	T20	200	5,5	232	100	32	10
01334	T25	100	4,5	132	100	32	10
01335	T25	200	5,5	232	100	32	10
01336	T27	100	5,5	132	100	32	10
01337	T27	200	5,5	232	100	32	5
01338	T30	100	6,0	132	100	32	10
01339	T30	200	6,0	232	100	32	5
01340	T40	100	7,0	132	100	32	10
01341	T40	200	7,0	232	100	32	5
01343	T45	250	8,0	288	120	38	5
01345	T50	250	9,0	288	120	38	5

L-key with T-handle

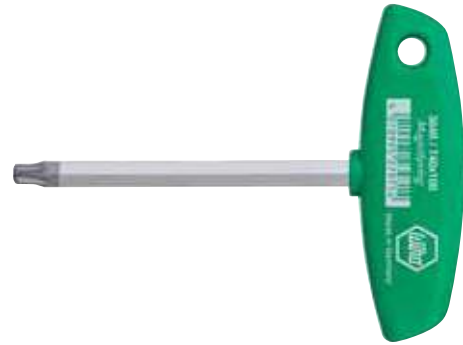

TORX® MagicSpring® matt chrome-plated

364R

Order-No.	●	⇄	●	⇄	⇄	⇄	📦
27964	T9	100	4,0	126	80	26	10
27965	T10	100	4,0	126	80	26	10
27966	T15	100	4,0	126	80	26	10
27967	T20	100	4,0	132	100	32	10
27968	T25	100	5,0	132	100	32	10
27969	T27	100	6,0	132	100	32	10
27970	T30	100	6,0	132	100	32	10
27971	T40	100	8,0	132	100	32	10

L-key with T-handle



TORX PLUS® matt chrome-plated

364IP

Order-No.	●	⇄	●	⇄	⇄	⇄	📦
26953	9IP	100	4,0	126	80	26	10
26954	10IP	100	4,0	126	80	26	10
26955	15IP	100	4,0	126	80	26	10
26956	20IP	100	4,0	132	100	32	10
26957	25IP	150	4,5	182	100	32	10
26958	27IP	150	5,5	182	100	32	10
26959	30IP	150	6,0	182	100	32	10
26960	40IP	150	7,0	182	100	32	10

L-key with key handle



Hex , black oxidised

331

Order-No.	●	↔	↔	↔	📦
00894	1,5	60	95	40	10
00895	2	60	95	40	10
00896	2,5	60	95	40	10
00897	3	60	95	40	10

L-key with flag handle



TORX®, black oxidised

370

Order-No.	●	↔	●	↔	↔	📦
03724	T5	35	2,0	62	15	10
03725	T6	35	2,0	62	15	10
03726	T7	35	2,5	67	19	10
03727	T8	40	2,5	72	19	10
03728	T9	40	3,0	74	24	10
03729	T10	40	3,0	74	24	10
03730	T15	45	3,5	80	28	10
03731	T20	45	4,0	80	28	10

L-key with key handle



TORX®, black oxidised

365

Order-No.	●	↔	●	↔	↔	📦
04918	T5	35	2,0	70	40	10
01350	T6	35	2,0	70	40	10
01351	T7	35	2,5	70	40	10
01352	T8	40	2,5	75	40	10
01353	T9	40	3,0	75	40	10
01354	T10	40	3,0	75	40	10
01355	T15	45	3,5	80	40	10
01356	T20	45	4,0	80	40	10

L-key with flag handle



TORX PLUS®, black oxidised

370IP

Order-No.	●	↔	●	↔	↔	📦
27614	5IP	35	2,0	67	15	10
27615	6IP	35	2,0	67	15	10
27616	7IP	35	2,5	67	19	10
27617	8IP	40	2,5	72	19	10
27618	9IP	40	3,0	74	24	10
27619	10IP	40	3,0	74	24	10
27620	15IP	45	3,5	80	28	10
27621	20IP	45	4,0	80	28	10

L-key with key handle



TORX PLUS®, black oxidised

365IP

Order-No.	●	↔	●	↔	↔	📦
26181	5IP	35	2,0	70	40	10
26182	6IP	35	2,0	70	40	10
26183	7IP	35	2,5	70	40	10
26184	8IP	40	2,5	75	40	10
26185	9IP	40	3,0	75	40	10
26186	10IP	40	3,0	75	40	10
26187	15IP	45	3,5	80	40	10
26188	20IP	45	4,0	80	40	10

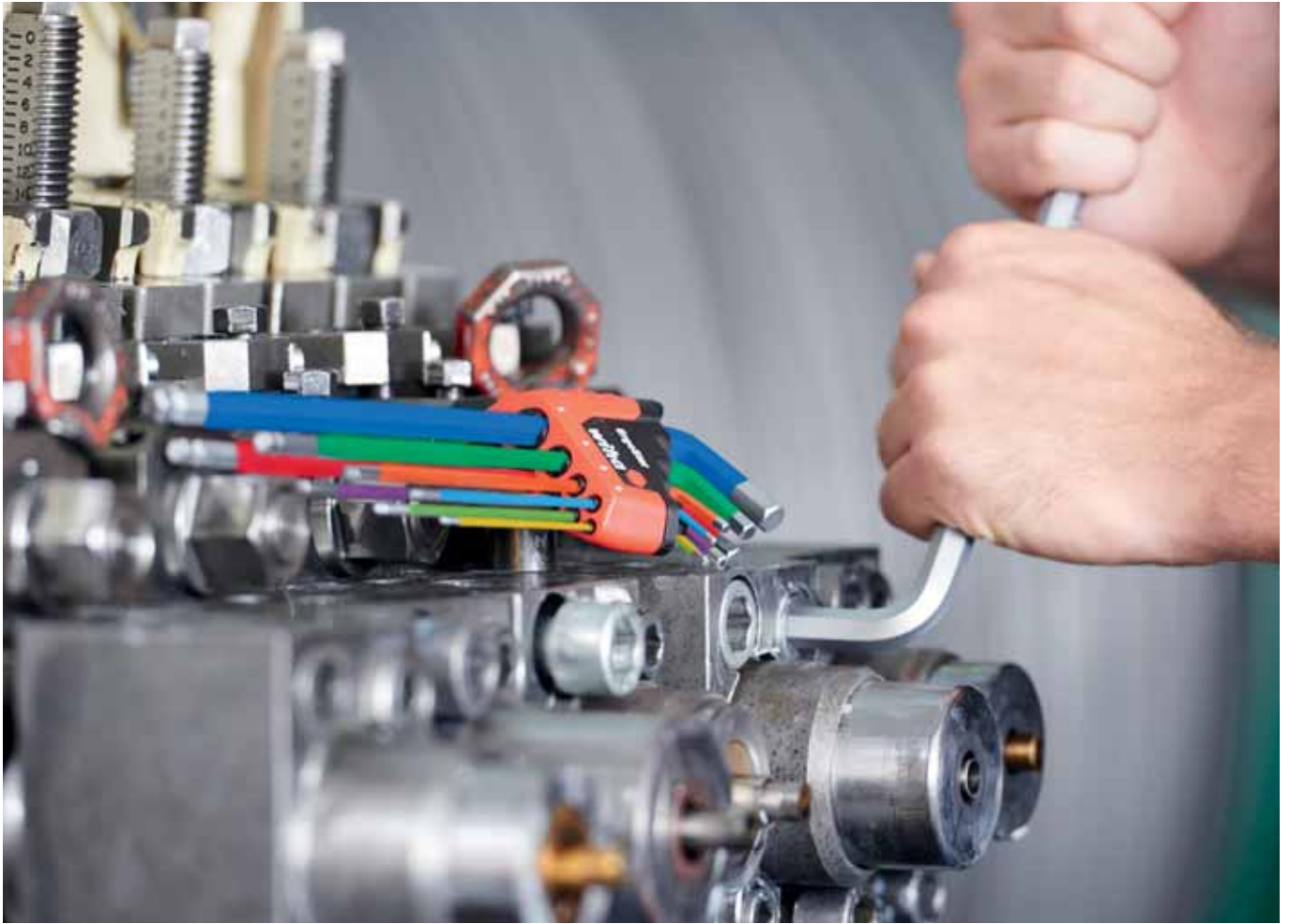























Bits

The indispensable three.

Which machine? Which application? Which bit? The revolutionary Wiha bit concept puts an end to any confusion and presents three bit types which can cover all areas of use.

Only the screw shape is crucial for selecting the bit. The Y bit is ideal for fastening Y-shaped screws with an angle no greater than 90° between the thread and screw head. The T bit is used for T-shaped screws at a 90° angle. If you need to fasten both screw types, then the TY bit is the right choice since this universal bit is suitable for all type of fastenings.

A selection of different bit holders and bit boxes such as the BitBuddy® and XLSelector ensures optimum usage of bits.

Application	Bits			
For all screw types	BitBuddy® TY bit set, 49 mm Page 222 	BitBuddy® TY bit set, 29 mm Page 223 	TY bit set 49 mm Page 222 	TY bit set 29 mm Page 224 
For T-shaped screws	XLSelector T bit set, 50 mm Page 224 	FlipSelector T bit set, 25 mm Page 225 	T bit set, 50 mm Page 225 	T bit set, 25 mm Page 225 
For Y-shaped screws	XLSelector Y bit set, 50 mm Page 226 	FlipSelector Y bit set, 25 mm Page 227 	Y bit set, 50 mm Page 226 	Y bit set, 25 mm Page 226 
For universal focus	Bit set XLSelector Standard 25 mm assorted 1/4" 31-pcs. Page 227 	Bit set FlipSelector Standard 25 mm assorted 1/4" 13-pcs. Page 228 	Bit Standard 25 mm 1/4" Page 231 	Bit Professional 1/4" Page 236 
MicroBits	Micro-bit set ESD assorted 65-pcs. Page 241 	Micro-bit 28 mm Slotted drive 4 mm Page 241 		
Bit holder	Bit holder CentroFix Force mechanically lockable 1/4", magnetic Page 246 	Bit holder CentroFix Super Slim mechanically lockable 1/4", magnetic Page 246 	Bit holder MagicFlip Force magnetic with ring magnet, 1/4" Page 246 	Screwdriver with SoftFinish® CentroFix bit holder, mechanically lockable 1/4" Page 248 
Special solutions	High-performance offset screwdriver with quick release holder 1/4" Page 249 	Wood drill bit 1/4" Page 243 	Countersink bit 1/4" Page 244 	



BitBuddy® TY bit set, 49 mm



Pozidriv 1/4" 7-pcs.

SB 7946-TY202

Order-No.	
42099	6

1 x PZ1 / 5 x PZ2 / 1 x PZ3

•compared to Wiha standard bit

TORX® 1/4" 7-pcs.

SB 7946-TY505

Order-No.	
42115	6

1 x T10 / 1 x T15 / 2 x T20 / 1 x T25 / 1 x T30 / 1 x T40

•compared to Wiha standard bit

Hexagon 1/4" 7-pcs.

SB 7946-TY303

Order-No.	
42114	6

2 x SW3 / 2 x SW4 / 2 x SW5 / 1 x SW6

•compared to Wiha standard bit

Phillips, Pozidriv, TORX®, 7-pcs., 1/4"

SB 7946-TY903

Order-No.	
42116	6

1 x PH2

1 x PZ3 / 1 x PZ1 / 1 x PZ2

1 x T15 / 1 x T20 / 1 x T25

•compared to Wiha standard bit

Phillips, Pozidriv, TORX®, 7-pcs., 1/4"

SB 7946-TY904

Order-No.	
42117	6

1 x PH2

1 x PZ1 / 1 x PZ2

1 x T10 / 1 x T15 / 1 x T20 / 1 x T25

•compared to Wiha standard bit

Pozidriv, TORX® 7-pcs. 1/4" in box

SB 7946-TY905

Order-No.	
42118	6

1 x PZ2 / 1 x PZ3

1 x T15 / 1 x T20 / 1 x T25 / 1 x T30 / 1 x T40

•compared to Wiha standard bit

TY bit set 49 mm



Order-No.		
42097	⊕ 5 x PH1	6
42119	⊕ 5 x PH2	6
42120	⊕ 5 x PH3	6
42121	⊕ 5 x PZ1	6
42122	⊕ 5 x PZ2	6
42123	⊕ 5 x PZ3	6
42124	● 5 x SW3	6
42125	● 5 x SW4	6
42126	● 5 x SW5	6
42127	● 5 x SW6	6
42128	⊕ 5 x T10	6
42129	⊕ 5 x T15	6
42130	⊕ 5 x T20	6
42131	⊕ 5 x T25	6
42132	⊕ 5 x T27	6
42133	⊕ 5 x T30	6
42134	⊕ 5 x T40	6

•compared to Wiha standard bit

INFOBOX:
BitBuddy 29



Easy, single-hand operation.

Attaching:

- Bits are directly picked up with the machine from the BitBuddy.

Work:

- Gets your fastenings done.

Storing

- Bits are easily returned to the BitBuddy, by pressing on the red bit strip.
- With magnetic bit holder for a rapid bit change.
- BitBuddy is always at hand - easily fits into trouser pockets or onto the belt clip.



Pozidriv 1/4" 8-pcs.

SB 7945-TY202

Order-No.	
42098	6
	1 x PZ1 / 5 x PZ2 / 1 x PZ3
	1 x Bit holder magnetic extra strong magnet 1/4"

*compared to Wiha standard bit

TORX® 1/4" 8-pcs.

SB 7945-TY505

Order-No.	
42136	6
	1 x T10 / 1 x T15 / 2 x T20 / 1 x T25 / 1 x T30 / 1 x T40
	1 x Bit holder magnetic extra strong magnet 1/4"

*compared to Wiha standard bit

Hexagon 8-pcs. 1/4"

SB 7945-TY303

Order-No.	
42135	6
	2 x SW3 / 2 x SW4 / 2 x SW5 / 1 x SW6
	1 x Bit holder magnetic extra strong magnet 1/4"

*compared to Wiha standard bit

Phillips, Pozidriv, TORX®, 8-pcs., 1/4"

SB 7945-TY903

Order-No.	
42137	6
	1 x PH2
	1 x PZ1 / 1 x PZ2 / 1 x PZ3
	1 x T15 / 1 x T20 / 1 x T25
	1 x Bit holder magnetic extra strong magnet 1/4"

*compared to Wiha standard bit

Phillips, Pozidriv, TORX®, 8-pcs., 1/4"

SB 7945-TY904

Order-No.	
42138	6
	1 x PH2
	1 x PZ1 / 1 x PZ2
	1 x T10 / 1 x T15 / 1 x T20 / 1 x T25
	1 x Bit holder magnetic extra strong magnet 1/4"

*compared to Wiha standard bit

Phillips, Pozidriv, TORX®, 8-pcs., 1/4"

SB 7945-TY905

Order-No.	
42139	6
	1 x PZ2 / 1 x PZ3
	1 x T15 / 1 x T20 / 1 x T25 / 1 x T30 / 1 x T40
	1 x Bit holder magnetic extra strong magnet 1/4"

*compared to Wiha standard bit

**INFOBOX:
Wiha TY bit concept**



- Bits quickly and easily selected thanks to the screw head shape.
- The T bit is ideal for fastening T-shaped screws with an angle of 90°.
- The Y bit is ideal for fastening Y-shaped screws with an angle not equal to 90°.
- Universal in its use, the TY bit is suitable for all types of screws, no matter whether they feature a Y-shaped or T-shaped screw head.

Wiha Bitfinder

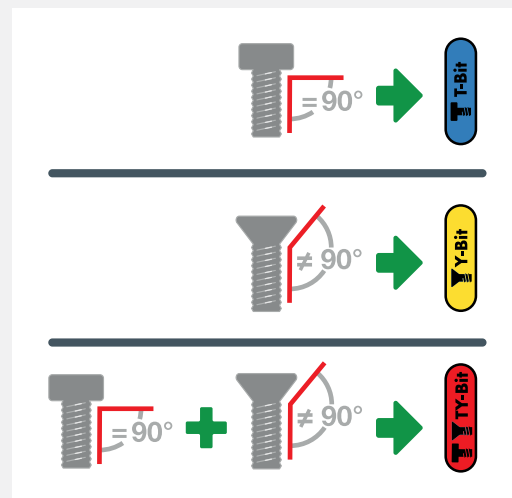

TY bit set 29 mm



Order-No.		
42096	⊕ 5 x PH1	6
42100	⊕ 5 x PH2	6
42101	⊕ 5 x PH3	6
42149	⊕ 5 x PZ1	6
42102	⊕ 5 x PZ2	6
42103	⊕ 5 x PZ3	6
42104	● 5 x SW3	6
42105	● 5 x SW4	6
42106	● 5 x SW5	6
42107	● 5 x SW6	6
42108	⊕ 5 x T10	6
42109	⊕ 5 x T15	6
42110	⊕ 5 x T20	6
42111	⊕ 5 x T25	6
42112	⊕ 5 x T27	6
42113	⊕ 5 x T30	6
42150	⊕ 5 x T40	6

•compared to Wiha standard bit

XLSelector T bit set, 50 mm



Phillips, TORX®, hex 13-pcs. 1/4"

SB 7948-T950

Order-No.		
41831		6
⊕	1 x PH1 / 1 x PH2 / 1 x PH3	
●	1 x SW3 / 1 x SW4 / 1 x SW5 / 1 x SW6	
⊕	1 x T15 / 1 x T20 / 1 x T25 / 1 x T30 / 1 x T40	
○	1 x Bit holder magnetic extra strong magnet, 1/4"	

•compared to Wiha standard bit

XLSelector T bit set, 25 mm



Phillips, TORX®, hex 31-pcs. 1/4"

SB 7948-T999

Order-No.		
41830		6
⊕	2 x PH1 / 4 x PH2 / 2 x PH3	
●	2 x SW3 / 2 x SW4 / 2 x SW5 / 2 x SW6	
⊕	2 x T10 / 2 x T15 / 4 x T20 / 2 x T25 / 2 x T30 / 2 x T40	
○	1 x Bit holder magnetic extra strong magnet, 1/4"	

•compared to Wiha standard bit

FlipSelector T bit set, 25 mm



Hexagon 16-pcs. 1/4"

SB 7947-T303

Order-No.	Icon	Quantity
41825		6
		3 x SW3 / 3 x SW4 / 3 x SW5 / 3 x SW6
		1 x Bit holder magnetic extra strong magnet 1/4"

•compared to Wiha standard bit

Phillips, Pozidriv, TORX®, 13-pcs., 1/4"

SB 7947-T906

Order-No.	Icon	Quantity
41824		6
		1 x PH1 / 3 x PH2 / 1 x PH3
		1 x PZ2
		1 x T10 / 1 x T15 / 1 x T20 / 1 x T25 / 1 x T30 / 1 x T40
		1 x Bit holder magnetic extra strong magnet 1/4"

•compared to Wiha standard bit

assorted 1/4" 13-pcs.

SB 7947-T999

Order-No.	Icon	Quantity
41826		6
		1 x PH1 / 1 x PH2 / 1 x PH3
		1 x PZ2
		1 x SW4 / 1 x SW5 / 1 x SW6
		1 x T15 / 1 x T20 / 1 x T25 / 1 x T30 / 1 x T40
		1 x Bit holder magnetic extra strong magnet 1/4"

•compared to Wiha standard bit

T bit set, 50 mm



Order-No.	Icon	Quantity
41637		6
41638		6
41639		6
41640		6
41641		6
41642		6
41650		6
41651		6
41652		6
41653		6
41643		6
41644		6
41645		6
41646		6
41647		6
41648		6
41649		6
41660		6
41662		6
41663		6

•compared to Wiha standard bit

T bit set, 25 mm



Order-No.	Icon	Quantity
41598		6
41599		6
41600		6
41601		6
41602		6
41603		6
41611		6
41612		6
41613		6
41614		6
41604		6
41605		6
41606		6
41607		6
41608		6
41609		6
41610		6
41621		6
41622		6
41623		6

•compared to Wiha standard bit

XLSelector Y bit set, 50 mm



Phillips, Pozidriv, TORX®, 13-pcs., 1/4"

SB 7948-Y950

Order-No.		
41834		6
	2 x PH2	
	1 x PZ1 / 2 x PZ2 / 1 x PZ3	
	1 x T10 / 1 x T15 / 1 x T20 / 1 x T25 / 1 x T30 / 1 x T40	
	1 x Bit holder magnetic extra strong magnet, 1/4"	

*compared to Wiha standard bit

XLSelector Y bit set, 25 mm



TORX® 31-pcs. 1/4"

SB 7948-Y505

Order-No.		
41833		6
	3 x T10 / 6 x T15 / 6 x T20 / 6 x T25 / 6 x T30 / 3 x T40	
	1 x Bit holder magnetic extra strong magnet 1/4"	

*compared to Wiha standard bit

Phillips, Pozidriv, TORX®, 31-pcs., 1/4"

SB 7948-Y904

Order-No.		
41832		6
	1 x PH1 / 1 x PH3 / 4 x PH2	
	2 x PZ1 / 4 x PZ2 / 2 x PZ3	
	2 x T10 / 3 x T15 / 3 x T20 / 3 x T25 / 3 x T30 / 2 x T40	
	1 x Bit holder magnetic extra strong magnet 1/4"	

*compared to Wiha standard bit

Y bit set, 50 mm



Order-No.		
41624	5 x PH1	6
41625	5 x PH2	6
41626	5 x PH3	6
41627	5 x PZ1	6
41628	5 x PZ2	6
41629	5 x PZ3	6
41630	5 x T10	6
41631	5 x T15	6
41632	5 x T20	6
41633	5 x T25	6
41634	5 x T27	6
41635	5 x T30	6
41636	5 x T40	6

*compared to Wiha standard bit

Y bit set, 25 mm



Order-No.		
41585	5 x PH1	6
41586	5 x PH2	6
41587	5 x PH3	6
41588	5 x PZ1	6
41589	5 x PZ2	6
41590	5 x PZ3	6
41591	5 x T10	6
41592	5 x T15	6
41593	5 x T20	6
41594	5 x T25	6
41595	5 x T27	6
41596	5 x T30	6
41597	5 x T40	6

*compared to Wiha standard bit

FlipSelector Y bit set, 25 mm



Pozidriv 1/4" 13-pcs.

SB 7947-Y202

Order-No.	
41829	6
	2 x PZ1 / 8 x PZ2 / 2 x PZ3
	1 x Bit holder magnetic extra strong magnet 1/4"

•compared to Wiha standard bit

TORX® 1/4" 13-pcs.

SB 7947-Y505

Order-No.	
41828	6
	2 x T10 / 2 x T15 / 3 x T20 / 2 x T25 / 2 x T30 / 1 x T40
	1 x Bit holder magnetic extra strong magnet 1/4"

•compared to Wiha standard bit

Phillips, Pozidriv, TORX®, 13-pcs., 1/4"

SB 7947-Y904

Order-No.	
41827	6
	2 x PH2
	1 x PZ1 / 2 x PZ2 / 1 x PZ3
	1 x T10 / 1 x T15 / 1 x T20 / 1 x T25 / 1 x T30 / 1 x T40
	1 x Bit holder magnetic extra strong magnet 1/4"

•compared to Wiha standard bit

Belt clip



for bit set BitBuddy® and FlipSelector

7945

Order-No.	
36990	10

Bit set XLSelector Standard 25 mm



assorted with bit ratchet form C 6.3 (1/4"), 17-pcs.

7948-043

Order-No.	
36951	5
	1 x PH1 / 1 x PH2
	1 x PZ1 / 1 x PZ2 / 1 x PZ3
	1 x T10 / 1 x T15 / 1 x T20 / 1 x T25 / 1 x T30 / 1 x T40
	1 x 3,0 / 1 x 4,0 / 1 x 5,0 / 1 x 6,0
	1 x Bit holder magnetic, 58 mm 1/4"
	1 x Bit ratchet 90 mm with thumb wheel Hexagon head, 1/4" in blister pack

Bit set XLSelector Standard 25 mm



assorted 1/4" 31-pcs.

7948-005

Order-No.	
29417	5
	1 x 4,5 / 1 x 5,5 / 1 x 6,5
	2 x PH1 / 4 x PH2 / 1 x PH3
	2 x PZ1 / 5 x PZ2 / 1 x PZ3
	2 x T10 / 2 x T15 / 2 x T20 / 3 x T25 / 2 x T30 / 1 x T40
	1 x Bit holder magnetic, 58 mm 1/4"

assorted 1/4" 31-pcs.

7948-927

Order-No.	
29416	5
	1 x 0 / 1 x 1 / 1 x 2 / 1 x 3 / 1 x 4
	1 x 4 / 1 x 6 / 1 x 8 / 1 x 10
	1 x TR2,0 / 1 x TR2,5 / 1 x TR3,0 / 1 x TR4,0 / 1 x TR5,0 / 1 x TR6,0
	1 x 6 / 1 x 8 / 1 x 10
	1 x T8H / 1 x T9H / 1 x T10H / 1 x T15H / 1 x T20H / 1 x T25H / 1 x T27H / 1 x T30H / 1 x T40H
	1 x #1 / 1 x #2 / 1 x #3
	1 x Bit holder CentroFix Force mechanically lockable 1/4", magnetisch

Bit set FlipSelector Standard 25 mm



assorted 1/4" 13-pcs.

7947-999

Order-No.	
39078	10
⊖	1 x 5,5
⊕	1 x PH2
⊗	1 x PZ1 / 1 x PZ2 / 1 x PZ3
⊛	1 x T15 / 1 x T20 / 1 x T25 / 1 x T30
●	1 x 3,0 / 1 x 4,0 / 1 x 5,0
○	1 x Bit holder magnetic, 58 mm 1/4"

Slotted, Phillips, Pozidriv 1/4" 13-pcs.

7947-005

Order-No.	
39029	10
⊖	1 x 5,5
⊕	1 x PH1 / 3 x PH2 / 1 x PH3
⊗	1 x PZ1 / 4 x PZ2 / 1 x PZ3
○	1 x Bit holder magnetic, 58 mm 1/4"

Pozidriv, TORX® 1/4" 13-pcs.

7947-904

Order-No.	
39040	10
⊕	2 x PH2
⊗	1 x PZ1 / 2 x PZ2 / 1 x PZ3
⊛	1 x T10 / 1 x T15 / 1 x T20 / 1 x T25 / 1 x T30 / 1 x T40
○	1 x Bit holder magnetic, 58 mm 1/4"

Pozidriv, TORX® 1/4" 13-pcs.

7947-905

Order-No.	
39041	10
⊗	1 x PZ1 / 2 x PZ2 / 1 x PZ3
⊛	1 x T10 / 1 x T15 / 2 x T20 / 2 x T25 / 1 x T30 / 1 x T40
○	1 x Bit holder magnetic, 58 mm 1/4"

TORX® 1/4" 13-pcs.

7947-505

Order-No.	
39124	10
⊛	1 x T7 / 1 x T8 / 1 x T9 / 1 x T10 / 2 x T15 / 2 x T20 / 2 x T25 / 1 x T30 / 1 x T40
○	1 x Bit holder magnetic, 58 mm 1/4"

TORX® Tamper Resistant (with hole) 1/4" 13-pcs.

7947-505TR

Order-No.	
39037	10
⊛	1 x T7H / 1 x T8H / 1 x T9H / 1 x T10H / 2 x T15H / 2 x T20H / 2 x T25H / 1 x T30H / 1 x T40H
○	1 x Bit holder magnetic, 58 mm 1/4"

Hexagon 1/4" 11-pcs.

7947-902

Order-No.	
39039	10
●	1 x 1,5 / 1 x 2,0 / 1 x 2,5 / 2 x 3,0 / 2 x 4,0 / 1 x 5,0 / 1 x 6,0 / 1 x 8,0
○	1 x Bit holder magnetic, 58 mm 1/4"

SIT (for Assy® and Pias screws), 13-pcs., 1/4"

7947-995

Order-No.	
39045	10
⊛	2 x SIT 10 / 4 x SIT 20 / 3 x SIT 25 / 2 x SIT 30 / 1 x SIT 40
○	1 x Bit holder magnetic, 58 mm 1/4"

Bit set FlipSelector Standard 25 mm



Slotted, Phillips, Pozidriv, 13-pcs., 1/4" with belt clip, in blister pack

SB 7947-005

Order-No.	
39049	5
⊖	1 x 5,5
⊕	1 x PH1 / 3 x PH2 / 1 x PH3
⊗	1 x PZ1 / 4 x PZ2 / 1 x PZ3
○	1 x Bit holder magnetic, 58 mm 1/4"

TORX®, 13-pcs., 1/4" with belt clip, in blister pack

SB 7947-505

Order-No.	
39056	5
⊛	1 x T7 / 1 x T8 / 1 x T9 / 1 x T10 / 2 x T15 / 2 x T20 / 2 x T25 / 1 x T30 / 1 x T40
○	1 x Bit holder magnetic, 58 mm 1/4"



TORX® Tamper Resistant (with drill hole), 13-pcs., 1/4" with belt clip, in blister pack

SB 7947-505TR

Order-No.	
39057	5
⊛	1 x T7H / 1 x T8H / 1 x T9H / 1 x T10H / 2 x T15H / 2 x T20H / 2 x T25H / 1 x T30H / 1 x T40H
○	1 x Bit holder magnetic, 58 mm 1/4"





Hex, 11-pcs., 1/4" with belt clip in blister pack

SB 7947-902

Order-No.	
39059	5
	1 x 1,5 / 1 x 2,0 / 1 x 2,5 / 2 x 3,0 / 2 x 4,0 / 1 x 5,0 / 1 x 6,0 / 1 x 8,0
	1 x Bit holder magnetic, 58 mm 1/4"





Phillips, Pozidriv, TORX®, 13-pcs., 1/4" with belt clip, in blister pack

SB 7947-904

Order-No.	
39060	5
	2 x PH2
	1 x PZ1 / 2 x PZ2 / 1 x PZ3
	1 x T10 / 1 x T15 / 1 x T20 / 1 x T25 / 1 x T30 / 1 x T40
	1 x Bit holder magnetic, 58 mm 1/4"



Phillips, Pozidriv, TORX®, 14-pcs., 1/4" with belt clip, in blister pack

SB 7947-905

Order-No.	
39061	5
	1 x PH2
	2 x PZ1 / 1 x PZ2 / 1 x PZ3
	1 x T10 / 1 x T15 / 2 x T20 / 2 x T25 / 1 x T30 / 1 x T40
	1 x Bit holder magnetic, 58 mm 1/4"







SIT (for Assy® and Pias screws), 1/4", 13-pcs. with belt clip in blister pack

SB 7947-995

Order-No.	
39082	5
	2 x SIT 10 / 4 x SIT 20 / 3 x SIT 25 / 2 x SIT 30 / 1 x SIT 40
	1 x Bit holder magnetic, 58 mm 1/4"

Mixed, 1/4", 13-pcs. with belt clip in blister pack

SB 7947-999









Order-No.	
39083	5
	1 x 5,5
	1 x PH2
	1 x PZ1 / 1 x PZ2 / 1 x PZ3
	1 x T15 / 1 x T20 / 1 x T25 / 1 x T30
	1 x 3,0 / 1 x 4,0 / 1 x 5,0
	1 x Bit holder magnetic, 58 mm 1/4"

Bit set Collector Standard 25 mm



assorted 1/4" 32-pcs.

7928-913







Order-No.	
34686	5
	1 x 4,5 / 1 x 5,5 / 1 x 6,5
	2 x PH1 / 5 x PH2 / 2 x PH3
	2 x PZ1 / 5 x PZ2 / 2 x PZ3
	1 x T10 / 1 x T15 / 1 x T20 / 1 x T25 / 1 x T30 / 1 x T40
	1 x 4,0 / 1 x 5,0 / 1 x 6,0
	1 x Bit holder CentroFix Force mechanically lockable 1/4", magnetic
	1 x Screwdriver with bit holder SoftFinish® magnetic 1/4"

Bit set Collector Standard 25 mm



assorted 1/4" 61-pcs.

7928-923









Order-No.	
07943	5
	1 x 4,5 / 1 x 5,5 / 1 x 6,5 / 1 x 8,0
	7 x PH1 / 13 x PH2 / 3 x PH3
	7 x PZ1 / 13 x PZ2 / 3 x PZ3
	1 x T10 / 1 x T15 / 1 x T20 / 1 x T25 / 1 x T30 / 1 x T40
	1 x 3,0 / 1 x 4,0 / 1 x 5,0 / 1 x 6,0
	1 x Bit holder CentroFix Force mechanically lockable 1/4", magnetic

Bit set Collector Security Standard 25 mm and torsion bits



assorted 1/4" 27-pcs.

7928-928







Order-No.	
09393	5
	1 x T8H / 1 x T10H / 1 x T15H / 1 x T20H / 1 x T25H / 1 x T27H / 1 x T30H / 1 x T40H
	1 x 6 / 1 x 8 / 1 x 10
	1 x 1 / 1 x 2 / 1 x 3 / 1 x 4
	1 x 4 / 1 x 6 / 1 x 8 / 1 x 10
	1 x TR5/64 / 1 x TR3/32 / 1 x TR7/64 / 1 x TR1/8 / 1 x TR9/64 / 1 x TR5/32
	1 x Bit holder magnetic extra strong magnet, 1/4"
	1 x Screwdriver with bit holder SoftFinish® magnetic 1/4"

Bit set Standard 25 mm







assorted, 31-pcs. in box, 1/4"

7979-01

Order-No.	
26252	1
	1 x 4,5 / 1 x 5,5 / 1 x 6,5
	2 x PH1 / 6 x PH2 / 1 x PH3
	2 x PZ1 / 6 x PZ2 / 1 x PZ3
	1 x T10 / 1 x T15 / 1 x T20 / 1 x T25 / 1 x T30 / 1 x T40
	1 x 4,0 / 1 x 5,0 / 1 x 6,0
	1 x Bit holder magnetic extra strong magnet 1/4"





TORX®, Pozidriv 1/4" 31-pcs.

7979-02

Order-No.	
26253	1
	5 x PZ1 / 10 x PZ2 / 3 x PZ3
	2 x T10 / 2 x T15 / 2 x T20 / 2 x T25 / 2 x T30 / 2 x T40
	1 x Bit holder magnetic extra strong magnet 1/4"

TORX®, Pozidriv 1/4" 31-pcs.

7979-03

Order-No.	
36310	1
	2 x PZ1 / 3 x PZ2 / 1 x PZ3
	2 x T10 / 6 x T15 / 6 x T20 / 6 x T25 / 2 x T30 / 2 x T40
	1 x Bit holder magnetic extra strong magnet 1/4"



⊖ Slotted 1/4"

7010 Z

Order-No.	⊖	mm	⊖	
01623	4,5	25	0,6	10
01624	5,5	25	0,8	10
01626	6,5	25	1,2	10
01627	8,0	25	1,6	10

⊕ Phillips 1/4"

7011 Z

Order-No.	⊕	mm	
05298	PH0	25	10
01657	PH1	25	10
01658	PH2	25	10
01659	PH3	25	10
01649	PH4	32	10

⊕ Pozidriv 1/4"

7012 Z

Order-No.	⊕	mm	
05300	PZ0	25	10
01688	PZ1	25	10
01689	PZ2	25	10
01690	PZ3	25	10
01681	PZ4	32	10

⊕ TORX® 1/4"

7015 Z

Order-No.	⊕	mm	
26250	T3	25	10
25097	T4	25	10
01711	T5	25	10
01712	T6	25	10
01713	T7	25	10
01714	T8	25	10
01715	T9	25	10
01716	T10	25	10
01717	T15	25	10
01718	T20	25	10
01719	T25	25	10
01720	T27	25	10
01721	T30	25	10
01722	T40	25	10
01723	T45	35	10
01724	T50	35	10

⊕ TORX® conical 1/4"

7015K Z

Order-No.	⊕	mm	
04925	T10	25	10
04926	T15	25	10
04927	T20	25	10
04928	T25	25	10
04929	T27	25	10
04930	T30	25	10
04931	T40	25	10

⊕ TORX PLUS® 1/4"

7016 Z

Order-No.	⊕	mm	
25994	3IP	25	10
25996	4IP	25	10
25998	5IP	25	10
23173	6IP	25	10
23175	7IP	25	10
23177	8IP	25	10
23179	9IP	25	10
23181	10IP	25	10
23183	15IP	25	10
23185	20IP	25	10
23187	25IP	25	10
23189	27IP	25	10
23191	30IP	25	10
23193	40IP	25	10



⊕ TORX® Tamper Resistant (with hole) 1/4"

7015 Z TR



Order-No.	⊕	mm	
03115	T7H	25	10
03117	T8H	25	10
01726	T9H	25	10
01727	T10H	25	10
01728	T15H	25	10
01729	T20H	25	10
01730	T25H	25	10
01731	T27H	25	10
01732	T30H	25	10
01733	T40H	25	10





TORX PLUS® Security, 1/4"
7016 Z IPR

Order-No.		mm	
27530	8IPR	25	10
26346	10IPR	25	10
26347	15IPR	25	10
26348	20IPR	25	10
26349	25IPR	25	10
26350	30IPR	25	10
26351	40IPR	35	10



MagicRing® hexagonal ball end, 1/4"
7017R Z

Order-No.		mm	
22959	3,0	38	10
22960	4,0	38	10
22961	5,0	38	10
22962	6,0	38	10



Hexagonal ball end 1/4"
7017 Z

Order-No.		mm	
01734	1,5	38	10
01735	2,0	38	10
01736	2,5	38	10
01737	3,0	38	10
01738	4,0	38	10
01739	5,0	38	10
01740	6,0	38	10



MagicRing® hex 1/4"
7013R Z

Order-No.		mm	
22955	3,0	25	10
22956	4,0	25	10
22957	5,0	25	10
22958	6,0	25	10



Hexagon 1/4"
7013 Z

Order-No.		mm	
04011	1,5	25	10
01703	2,0	25	10
01704	2,5	25	10
01705	3,0	25	10
01706	4,0	25	10
01707	5,0	25	10
39875	5,5	25	10
01708	6,0	25	10
01709	8,0	25	10
01710	10,0	25	10

Internal square 1/4"
7018 Z

Order-No.		mm	
06634	#1	2,3	5
06635	#2	2,8	5
06636	#3	3,3	5

Hexagon with hole 1/4"
7013 Z TR

Order-No.		mm	
25560	TR2,0	25	10
25561	TR2,5	25	10
25562	TR3,0	25	10
25563	TR4,0	25	10
25564	TR5,0	25	10
26309	TR6,0	25	10
20558	TR5/64	25	10
20556	TR3/32	25	10
20559	TR7/64	25	10
20555	TR1/8	25	10
20560	TR9/64	25	10
20557	TR5/32	25	10
30050	TR3/16	25	10

Spanner 1/4"
7019 Z SP

Order-No.		mm	
27064	4	25	10
27065	6	25	10
27066	8	25	10
27067	10	25	10



Triple square 1/4"
7019 Z XZN

Order-No.		mm	
26352	M3	25	10
26353	M4	25	10
26354	M5	25	10
26355	M6	25	10
26356	M8	35	10

SIT 1/4"
7019 Z SIT

Order-No.		mm		
27256	SIT 10	25	pink	10
27257	SIT 20	25	orange	10
27258	SIT 25	25	grün	10
27259	SIT 30	25	gelb	10
27260	SIT 40	25	rosa	10

Torq-Set® 1/4"
7019 Z TS

Order-No.		mm	
27030	0	25	10
27028	1	25	10
26249	2	25	10
26045	3	25	10
22591	4	25	10
22592	5	25	10
22593	6	25	10
22594	8	25	10
22595	10	25	10
25572	1/4	32	10

Tri-Wing® 1/4"

7019 Z TW

Order-No.		mm	
22603	0	25	10
22604	1	25	10
22605	2	25	10
22606	3	25	10
22607	4	25	10
22608	5	25	10

Bit DryWall Stop Standard 25 mm



Phillips 1/4"

7011 DWS

Order-No.		mm	
39382	PH2	25	10

**INFOBOX:
Ball end hex**



Wiha hexagonal ball end

- The ball end can be rotated by up to 25° in both clockwise and anti-clockwise direction.

**INFOBOX:
MagicRing®**

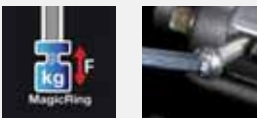

Wiha MagicRing®

- Spring steel ring reliably holds hex screws in place
- An innovation, which will benefit each user.

**INFOBOX:
TORX® tamper-resistant safety profile**



- This safety profile is used to hinder unwanted access to equipment such as intercoms, thermostats and night-storage heaters.
- You can fasten the Torx® tamper resistant profile with both Torx® H screws and normal Torx® screws.

Bit set Standard 25 mm



Order-No.		
32055	⊕ 10 x PH1	10
07855	⊕ 3 x PH1	10
36275	⊕ 20 x PH2	10
24733	⊕ 10 x PH2	10
07856	⊕ 3 x PH2	10
36280	⊕ 10 x PH3	10
07857	⊕ 3 x PH3	10
07858	1 x PH1 ⊕ 1 x PH2 1 x PH3	10
35709	⊕ 20 x PZ1	10
32070	⊕ 10 x PZ1	10
07859	⊕ 3 x PZ1	10
36282	⊕ 20 x PZ2	10
24742	⊕ 10 x PZ2	10
07860	⊕ 3 x PZ2	10
32071	⊕ 10 x PZ3	10
07861	⊕ 3 x PZ3	10
20542	⊕ 1 x PZ4	10
07862	1 x PZ1 ⊕ 1 x PZ2 1 x PZ3	10
35832	⊗ 10 x T10	10
08421	⊗ 2 x T10	10
34746	⊗ 10 x T15	10
08422	⊗ 2 x T15	10
24746	⊗ 10 x T20	10
08423	⊗ 2 x T20	10
08424	⊗ 2 x T25	10
24748	⊗ 10 x T25	10
26451	⊗ 2 x T27	10
08425	⊗ 2 x T30	10
08426	⊗ 2 x T40	10
36288	⊗ 10 x T40	10
38649	⊗ 2 x T10H	10
38650	⊗ 2 x T15H	10
38651	⊗ 2 x T20H	10

38652	⊗ 2 x T25H	10
38653	⊗ 2 x T30H	10
38654	⊗ 2 x T40H	10
22651	1 x 2,0 ● 1 x 2,5 1 x 3,0	10
22653	1 x 3,0 ● 1 x 4,0 1 x 5,0	10
22655	1 x 4,0 ● 1 x 5,0 1 x 6,0	10
07865	1 x 2,0 ● 1 x 2,5 1 x 3,0	10
07866	1 x 4,0 ● 1 x 5,0 1 x 6,0	10
38656	● 2 x 3,0	10
25681	● 2 x 4,0	10
25679	● 2 x 5,0	10
38657	● 2 x 6,0	10
38658	■ 2 x #1 x 2,3	10
38659	■ 2 x #2 x 2,8	10
38660	■ 2 x #3 x 3,3	10
38661	1 x #1 x 2,3 ■ 2 x #2 x 2,8 3 x #3 x 3,3	10

Standard bit reduced diameter: 25 mm



Order-No.		
35834	⊕ 10 x PH2	10
36285	⊕ 10 x PZ2	10

Bit set DryWall Stop 25 mm



Phillips, 2-pcs. in box, 1/4"

7011 DWS

Order-No.	
27077	1
	PH2 x 25

Bit set Standard 25 mm



Phillips (PH1), 50-pcs. in bulk pack, 1/4"

7929 Z

Order-No.	
08047	1
	PH1 x 25

Phillips (PH2), 50-pcs. in bulk pack, 1/4"

7929 Z

Order-No.	
08048	1
	PH2 x 25

Phillips (PH3), 50-pcs. in bulk pack, 1/4"

7929 Z

Order-No.	
08049	1
	PH3 x 25

Pozidriv (PZ1), 50-pcs. in bulk pack, 1/4"

7929 Z

Order-No.	
08056	1
	PZ1 x 25

Pozidriv (PZ2), 50-pcs. in bulk pack, 1/4"

7929 Z

Order-No.	
08057	1
	PZ2 x 25

Pozidriv (PZ3), 50-pcs. in bulk pack, 1/4"

7929 Z

Order-No.	
08058	1
	PZ3 x 25

TORX® (T10), 50-pcs. in bulk pack, 1/4"

7929 Z

Order-No.	
08065	1
	T10 x 25

TORX® (T15), 50-pcs. in bulk pack, 1/4"

7929 Z

Order-No.	
08066	1
	T15 x 25

TORX® (T20), 50-pcs. in bulk pack, 1/4"

7929 Z

Order-No.	
08067	1
	T20 x 25

TORX® (T25), 50-pcs. in bulk pack, 1/4"

7929 Z

Order-No.	
08068	1
	T25 x 25

TORX® (T27), 50-pcs. in bulk pack, 1/4"

7929 Z

Order-No.	
29544	1
	T27 x 25

TORX® (T30), 50-pcs. in bulk pack, 1/4"

7929 Z

Order-No.	
08069	1
	T30 x 25

TORX® (T40), 50-pcs. in bulk pack, 1/4"

7929 Z

Order-No.	
08070	1
	T40 x 25

Bit set Standard 25 mm



Phillips (PH2), 100-pcs. in bulk pack, 1/4"

7930 Z

Order-No.	
40461	1
	PH2 x 25

Pozidriv (PZ2), 100-pcs. in bulk pack, 1/4"

7930 Z

Order-No.	
40462	1
	PZ2 x 25

TORX® (T20), 100-pcs. in bulk pack, 1/4"

7930 Z

Order-No.	
40463	1
	T20 x 25

TORX® (T25), 100-pcs. in bulk pack, 1/4"

7930 Z

Order-No.	
40464	1
	T25 x 25

TORX® (T30), 100-pcs. in bulk pack, 1/4"

7930 Z

Order-No.	
40465	1
	T30 x 25

Bit Professional



Slotted 1/4"

7040 Z

Order-No.		mm		
33961	2,5	70	0,4	5
01790	3,0	50	0,5	5
33962	3,0	70	0,5	5
01792	3,5	50	0,6	5
33963	3,5	70	0,6	5
01791	4,0	50	0,5	5
01794	4,0	50	0,8	5
33964	4,0	70	0,8	5
01793	4,5	50	0,6	5
01795	5,5	50	0,8	5
01796	5,5	50	1,0	5
33965	5,5	70	1,0	5
01798	6,5	50	1,2	5
33966	6,5	70	1,2	5
01799	8,0	50	1,2	5
01800	8,0	50	1,6	5

Phillips 1/4"

7041 Z

Order-No.		mm	
31960	PH00	50	5
31961	PH00	70	5
31962	PH00	90	5
32105	PH0	50	5
35456	PH0	70	5
35457	PH0	90	5
33703	PH1	50	5
01803	PH1	70	5
04126	PH1	90	5
23213	PH1	110	5
23219	PH1	127	5
22509	PH1	150	5
33704	PH2	50	5
01805	PH2	70	5
04009	PH2	90	5
05800	PH2	110	5
06888	PH2	127	5
22510	PH2	150	5
33705	PH3	50	5
04010	PH3	70	5
04127	PH3	90	5
23215	PH3	110	5
23217	PH3	127	5
22511	PH3	150	5

⊕ Pozidriv 1/4"**7042 Z**

Order-No.	⊕	mm	
31957	PZ0	50	5
31958	PZ0	70	5
31959	PZ0	90	5
33706	PZ1	50	5
01808	PZ1	70	5
01809	PZ1	90	5
23221	PZ1	110	5
23225	PZ1	127	5
23227	PZ1	150	5
33707	PZ2	50	5
01811	PZ2	70	5
01812	PZ2	90	5
05799	PZ2	110	5
06889	PZ2	127	5
23228	PZ2	150	5
33708	PZ3	50	5
04059	PZ3	70	5
04176	PZ3	90	5
23223	PZ3	110	5
23226	PZ3	127	5
22512	PZ3	150	5

⊕ PlusMinus/Phillips 1/4"**7049XH**

Order-No.	⊕	mm	
32490	SL/PH1	50	5
32491	SL/PH1	70	5
32686	SL/PH1	90	5
32492	SL/PH2	50	5
32493	SL/PH2	70	5
32687	SL/PH2	90	5

⊕ PlusMinus/Pozidriv 1/4"**7049XZ**

Order-No.	⊕	mm	
32494	SL/PZ1	50	5
32495	SL/PZ1	70	5
32688	SL/PZ1	90	5
32496	SL/PZ2	50	5
32497	SL/PZ2	70	5
32689	SL/PZ2	90	5

⊕ TORX® ball end 1/4"**7045BE**

Order-No.	⊕	mm	
32409	T9	50	5
32410	T10	50	5
32416	T10	70	5
32417	T15	50	5
32418	T15	70	5
32411	T20	50	5
32419	T20	70	5

32412	T25	50	5
32421	T25	70	5
32413	T27	50	5
32414	T30	50	5
32423	T30	70	5
32415	T40	50	5

⊕ TORX® MagicSpring® 1/4"**7045R**

Order-No.	⊕	mm	
34452	T10	50	5
34453	T15	50	5
34454	T20	50	5
34455	T25	50	5
34456	T30	50	5
34457	T40	50	5



⊕ TORX® 1/4"**7045 Z**

Order-No.	⊕	mm	
39184	T1	50	5
39185	T2	50	5
39186	T3	50	5
39187	T4	50	5
32299	T5	50	5
32302	T6	50	5
33709	T6	70	5
33717	T6	90	5
38370	T6	150	5
32303	T7	50	5
33710	T7	70	5
33718	T7	90	5
38371	T7	150	5
32304	T8	50	5
33711	T8	70	5
33719	T8	90	5
36327	T8	150	5
32305	T9	50	5
33712	T9	70	5
33720	T9	90	5
38372	T9	150	5
32306	T10	50	5
33713	T10	70	5
33721	T10	90	5
33725	T10	110	5
33726	T10	150	5
32307	T15	50	5
33714	T15	70	5
33722	T15	90	5
33727	T15	110	5
33728	T15	150	5
32308	T20	50	5
33715	T20	70	5

33723	T20	90	5
33729	T20	110	5
33730	T20	150	5
32309	T25	50	5
33716	T25	70	5
33724	T25	90	5
33731	T25	110	5
33732	T25	150	5
33920	T27	50	5
33921	T27	70	5
33922	T27	90	5
33923	T30	50	5
33924	T30	70	5
33925	T30	90	5
33926	T30	110	5
33927	T30	150	5
33928	T40	50	5
33929	T40	70	5
33930	T40	90	5
33931	T40	110	5
33932	T40	150	5



TORX® Tamper Resistant (with hole) 1/4"

7045 Z TR

Order-No.		mm	
21045	T7H	50	5
21047	T8H	50	5
20218	T9H	50	5
20219	T10H	50	5
39188	T10H	90	5
24867	T15H	50	5
39189	T15H	90	5
20220	T20H	50	5
39190	T20H	90	5
20221	T25H	50	5
39191	T25H	90	5
20222	T27H	50	5
39192	T27H	90	5
20223	T30H	50	5
39193	T30H	90	5
20224	T40H	50	5
39194	T40H	90	5

TORX PLUS® 1/4"

7046 Z

Order-No.		mm	
39195	1IP	50	5
39196	2IP	50	5
32486	3IP	50	5
39197	4IP	50	5
39198	4IP	90	5
28481	5IP	50	5
39199	5IP	90	5
31973	6IP	90	5
26000	6IP	50	5
26002	7IP	50	5
23195	8IP	50	5
31975	8IP	90	2
23197	9IP	50	5
23199	10IP	50	5
31977	10IP	90	5
23201	15IP	50	5
25553	15IP	90	5
23203	20IP	50	5
39200	20IP	90	5
23205	25IP	50	5
39201	25IP	90	5
23207	27IP	50	5
39202	27IP	90	5
23209	30IP	50	5
39203	30IP	90	5
23211	40IP	50	5
39204	40IP	90	5

Hexagonal ball end 1/4"

7047R Z

Order-No.		mm	
25739	3,0	50	5
25740	4,0	50	5
25741	5,0	50	5
25742	6,0	50	5

MagicRing® hex 1/4"

7043R Z

Order-No.		mm	
23145	3,0	50	5
23147	4,0	50	5
23149	5,0	50	5
23151	6,0	50	5

● Hexagon 1/4"

7043 Z

Order-No.	●	mm	
05301	1,5	50	5
05302	2,0	50	5
34554	2,0	70	5
39178	2,0	90	5
05303	2,5	50	5
34555	2,5	70	5
39179	2,5	90	5
04194	3,0	50	5
34556	3,0	70	5
39180	3,0	90	5
04195	4,0	50	5
34557	4,0	70	5
39181	4,0	90	5
04196	5,0	50	5
34558	5,0	70	5
39182	5,0	90	5
04197	6,0	50	5
34559	6,0	70	5
39183	6,0	90	5
04198	8,0	50	5
34560	8,0	70	5

■ Square 1/4"

7048 Z

Order-No.	■	●	mm	
06637	#1	2,3	50	5
39206	#1	2,3	90	5
06638	#2	2,8	50	5
39207	#2	2,8	90	5
06639	#3	3,3	50	5
39208	#3	3,3	90	5

⊕ Torq-Set® 1/4"

7049 TS

Order-No.	⊕	mm	
22596	4	50	5
33699	4	90	5
22597	5	50	5
33700	5	90	5
22598	6	50	5
33701	6	90	5
22599	8	50	5
33702	8	90	5
22600	10	50	5



Bit Professional



Order-No.		
	1 x 3,0	
08419	⊖ 1 x 3,5 1 x 4,0	10
	1 x 5,5	
08420	⊖ 1 x 6,5 1 x 8,0	10
38676	⊕ 2 x PH1	10
38706	⊕ 2 x PH1	10
36193	⊕ 2 x PH2	10
38707	⊕ 2 x PH2	10
38677	⊕ 2 x PH3	10
38708	⊕ 2 x PH3	10
38679	⊕ 2 x PZ1	10
38709	⊕ 2 x PZ1	10
38680	⊕ 2 x PZ2	10
38710	⊕ 2 x PZ2	10
38681	⊕ 2 x PZ3	10
38711	⊕ 2 x PZ3	10
36086	⊕ 2 x SL/PZ1	10
36082	⊕ 2 x SL/PZ1	10
32805	⊗ 1 x T20	10
32806	⊗ 1 x T25	10
38684	⊗ 2 x T10	10
38712	⊗ 2 x T10	10
38685	⊗ 2 x T15	10
38713	⊗ 2 x T15	10
38686	⊗ 2 x T20	10
32808	⊗ 1 x T20	10
38714	⊗ 2 x T20	10
38687	⊗ 2 x T25	10
32809	⊗ 1 x T25	10
38715	⊗ 2 x T25	10
38688	⊗ 2 x T27	10
38716	⊗ 2 x T27	10
38689	⊗ 2 x T30	10
38717	⊗ 2 x T30	10
38690	⊗ 2 x T40	10

38718	⊗ 2 x T40	10
	1 x T10	
07874	⊗ 1 x T15 1 x T20	10
	1 x T20	
32807	⊗ 1 x T25 1 x T30	10
	1 x T25	
07875	⊗ 1 x T30 1 x T40	10

Bit set Professional 70 mm



TORX® ball end 1/4" in bit band 10-pcs.

7045BE 9570

Order-No.	
32804	1
⊗	2 x T10 / 2 x T15 / 2 x T20 / 2 x T25 / 2 x T30

INFOBOX: TORX® ball end

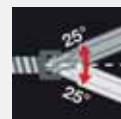

Wiha TORX® ball end

- With optimised TORX® ball end geometry
- Increased strength thanks to the special cold forming on a system developed by Wiha especially for this purpose.
- Allows fastening and unfastening at angles up to 25°.
- Simple insertion of the tool/bit and fastening/unfastening, especially in hard-to-reach positions.
- Broad product range: As an L-key, as a bit and as a SoftFinish® screwdriver.

Micro-bit set ESD



assorted 65-pcs.

7000 SK65 ESD

Order-No.	
39971	1
⊖	1 x 0,8 / 1 x 1,2 / 1 x 1,5 / 1 x 1,8 / 1 x 2,0 / 1 x 2,5 / 1 x 3,0 / 1 x 3,5 / 1 x 4,0
●	1 x 0,7 / 1 x 0,9 / 2 x 1,3 / (0,050") / 1 x 1,5 / 1 x 2,0 / 1 x 2,5 / 1 x 3,0 / 2 x 4,0 / (5/32")
●	1 x 3/32 / 1 x 1/16 / 1 x 5/64 / 1 x 7/64 / 1 x 1/8 / 1 x 9/64
⊕	1 x T3 / 1 x T4 / 1 x T5 / 1 x T6 / 1 x T7 / 1 x T8 / 1 x T9 / 1 x T10 / 1 x T15 / 1 x T20
⊕	1 x PL1 / 1 x PL2 / 1 x PL3 / 1 x PL4 / 1 x PL5 / 1 x PL6
⊕	1 x PH000 / 1 x PH00 / 1 x PH0 / 1 x PH1
○	1 x 2,0 / 1 x 2,5 / 1 x 3,0 / 1 x 3,5 / 1 x 4,0 / 1 x 4,5 / 1 x 5,0 / 1 x 5,5
○	1 x 5/64 / 1 x 3/32 / 1 x 7/64 / 1 x 1/8 / 1 x 9/64 / 1 x 5/32 / 1 x 3/16 / 1 x 7/32
○	1 x Adapter 1/4" for micro-bits 4 mm drive
○	1 x Bit ratchet 90 mm with thumb wheel Hexagon head, 1/4" in blister pack
○	1 x Screwdriver handle ESD for micro-bits 4 mm drive
○	1 x Extension 100 mm for ESD screwdriver handle and micro-bits

Micro-bit 28 mm



⊖ Slotted drive 4 mm

7000 4 Z

Order-No.	⊖	mm	⊖	
40600	0,8	28	0,20	10
40601	1,2	28	0,25	10
40602	1,5	28	0,25	10
40603	1,8	28	0,30	10
40604	2,0	28	0,40	10
40605	2,5	28	0,40	10
40606	3,0	28	0,50	10
40607	3,5	28	0,60	10
40608	4,0	28	0,80	10

⊕ Phillips drive 4 mm

7001 4 Z

Order-No.	⊕	mm	
40609	PH000	28	10
40610	PH00	28	10
40611	PH0	28	10
40612	PH1	28	10
40613	PH2	28	10



● Hexagon drive 4 mm

7003 4 Z

Order-No.	●	mm	
40614	0,7	28	10
40615	0,9	28	10
40616	1,3 / (0,050")	28	10
40617	1,5	28	10
40618	2,0	28	10
40619	2,5	28	10
40620	3,0	28	10
40621	4,0 / (5/32")	28	10
40622	1/16	28	10
40623	5/64	28	10
40624	3/32	28	10
40625	7/64	28	10
40626	1/8	28	10
40627	9/64	28	10



TORX® drive 4 mm

7005 4 Z

Order-No.		mm	
40628	T1	28	10
40629	T2	28	10
40630	T3	28	10
40631	T4	28	10
40632	T5	28	10
40633	T6	28	10
40634	T7	28	10
40635	T8	28	10
40636	T9	28	10
40637	T10	28	10
40638	T15	28	10
40639	T20	28	10

Pentalobe drive 4 mm

7009 4 Z



Order-No.		mm	
40640	PL1	28	10
40641	PL2	28	10
40642	PL3	28	10
40643	PL4	28	10
40644	PL5	28	10
40645	PL6	28	10

Micro nut driver 30 mm



Hexagon socket drive 4 mm

7044 4 Z

Order-No.		mm	
40654	2,0	30	10
40655	2,5	30	10
40656	3,0	30	10
40657	3,5	30	10
40658	4,0	30	10
40659	4,5	30	10
40660	5,0	30	10
40661	5,5	30	10
40646	5/64	30	10
40647	3/32	30	10
40648	7/64	30	10
40649	1/8	30	10
40650	9/64	30	10
40651	5/32	30	10
40652	3/16	30	10
40653	7/32	30	10

Extension 100 mm



for ESD screwdriver handle and micro-bits

710100

Order-No.			mm	
40663	4	4	100	10

Adapter 1/4"



for micro-bits 4 mm drive

7103

Order-No.			
39964	4	1/4	10

Bit holder magnetic



for micro-bits 4 mm drive

7110M

Order-No.			mm	
32505	4	1/4	60	10

**INFOBOX:
Pentalobe**



The security profile for Apple devices.

- Ideal for repairing Apple smartphones, tablets and notebooks.
- Note: The guarantee and warranty conditions of the device manufacturer must be observed.

Bit with thread



Phillips M4

7311 Z

Order-No.	⊕	mm	●	+	→	📦
01937	PH1	33	5,5	M4	8,00	10
01938	PH2	33	6,0	M4	8,00	10

Pozidriv M4

7312 Z

Order-No.	⊕	mm	●	+	→	📦
01939	PZ1	33	5,5	M4	8,00	10
01940	PZ2	33	6,0	M4	8,00	10

Phillips M5

7321 Z

Order-No.	⊕	mm	●	+	→	📦
01942	PH2	33	7,0	M5	8,00	10
01943	PH2	45	6,0	M5	8,00	10

Pozidriv M5

7322 Z

Order-No.	⊕	mm	●	+	→	📦
01945	PZ2	33	7,0	M5	8,00	10
01946	PZ2	45	6,0	M5	8,00	10

TORX® M5

7325 Z

Order-No.	⊕	mm	●	+	→	📦
35400	T10	45	6,0	M5	8,00	10
35401	T15	45	6,0	M5	8,00	10
35402	T20	45	6,0	M5	8,00	10
35403	T25	45	6,0	M5	8,00	10

Phillips M6

7331 Z

Order-No.	⊕	mm	●	+	→	📦
04678	PH2	33	8,0	M6	8,00	10
04677	PH2	45	8,0	M6	8,00	10

Pozidriv M6

7332 Z

Order-No.	⊕	mm	●	+	→	📦
04671	PZ2	33	8,0	M6	8,00	10
04670	PZ2	45	8,0	M6	8,00	10

Phillips UNF 10/32"

7341 Z

Order-No.	⊕	mm	●	+	→	📦
01947	PH2	45	6,0	10/32 UNF	8,00	10

Pozidriv UNF 10/32"

7342 Z

Order-No.	⊕	mm	●	+	→	📦
01948	PZ2	45	6,0	10/32 UNF	8,00	10

Wood drill bit



1/4"

7804

Order-No.	⊕	mm	→	●	📦
27873	3,0	70	36	1/4	10
27876	4,0	75	43	1/4	10
27877	5,0	85	56	1/4	10
27879	6,0	95	66	1/4	10
27880	8,0	110	81	1/4	10

Spiral drill bit



1/4"

7805

Order-No.	⊕	mm	→	●	📦
27882	3,0	38	16	1/4	10
28055	3,1	38	16	1/4	10
27883	3,3	40	18	1/4	10
27884	4,0	43	22	1/4	10
28056	4,1	43	22	1/4	10
27885	4,2	43	22	1/4	10
27886	5,0	48	26	1/4	10
28057	5,1	48	26	1/4	10
27887	6,0	48	26	1/4	10
27888	6,8	48	30	1/4	10
27889	8,0	50	32	1/4	10
27890	8,5	51	34	1/4	10
27891	10,0	54	37	1/4	10

Combination drill bit set



1/4" 5-pcs.

79187 B5

Order-No.	📦
28026	1
⊕	M3 x 36 / M4 x 39 / M5 x 41 / M6 x 44 / M8 x 51

Combination drill bit



1/4"

7807

Order-No.	Ø	mm	Ø1	Icon
27897	M3	36	1/4	10
27898	M4	39	1/4	10
27899	M5	41	1/4	10
27900	M6	44	1/4	10
27901	M8	51	1/4	10
27963	M10	65	1/4	10

Countersink bit set



1/4" 5-pcs.

79186 B5

Order-No.	Icon	6,3 x 35 / 8,3 x 35 / 10,4 x 35 / 12,4 x 35 / 16,5 x 35	1
28027	Icon		

Countersink bit



1/4"

7806

Order-No.	Icon	mm	Ø1	Icon	Ø min.	Icon	
27892	Icon	6,3	35	1/4	M3	1,5	10
27893	Icon	8,3	35	1/4	M4	2,0	10
27894	Icon	10,4	35	1/4	M5	2,5	10
27895	Icon	12,4	35	1/4	M6	2,8	10
27896	Icon	16,5	35	1/4	M8	3,2	10
28058	Icon	20,5	35	1/4	M10	3,5	10

Nut driver insert



Hexagon head 1/4"

7044

Order-No.	Ø	mm	Icon
04514	5,0	55	5
04513	5,5	55	5
04512	6,0	55	5
04511	7,0	55	5
04510	8,0	55	5
04509	10,0	55	5
04508	13,0	55	5
04515	1/4	55	5
04516	5/16	55	5
04517	3/8	55	5

Nut driver insert, magnetic



Hexagon head 1/4"

7044 M

Order-No.	Ø	mm	Icon
04637	5,0	55	5
04636	5,5	55	5
04635	6,0	55	5
04634	7,0	55	5
04633	8,0	55	5
04632	10,0	55	5
04631	13,0	55	5
04638	1/4	55	5
04639	5/16	55	5
04640	3/8	55	5

Tool shaft



Square, Internal hexagon C6,3

7210

Order-No.	Icon	Icon	Icon	Icon
01933	1/4	1/4	25	5
04204	3/8	1/4	30	5

Tool shaft



■ Square, Internal hexagon C6,3

7240

Order-No.	□	⊕	↔	📦
04685	1/4	1/4	100	5
01935	1/4	1/4	50	5
04684	3/8	1/4	100	5
04362	3/8	1/4	50	5

Adapter DIN 7428.

Hand impact screwdriver set



assorted 1/2" 6-pcs.

24636 B5

Order-No.	📦
32573	1

- Hand impact screwdriver Internal square 1/2"
- ⊖ 9 x 1,6 / 11 x 1,6
- ⊕ PH2 x 5/16 / PH3 x 5/16
- Heavy-duty bit holder clamping with ball Hexagon head, internal square form C 8 (5/16"), 1/2"

Connector with retaining ring



○ Hexagon head, Square head form G 6.3 + G 10 + G 12.5

7201

Order-No.	○	○:	↔	📦
01924	1/4	1/4	25 D 6,3	2
01926	1/4	3/8	30 D 6,3	2
01922	1/4	1/2	35 D 6,3	2
01927	5/16	3/8	30 D 8	2
01923	5/16	1/2	35 D 8	2

Hand impact screwdriver



■ Internal square 1/2"

24636

Order-No.	□	mm	📦
32556	1/2	163	1

Connector with quick release holder



○ Hexagon head, Square head form G 12.5

7203

Order-No.	○	⊕	↔	📦
01930	1/4	1/2	50	2

Heavy-duty bit holder clamping with ball



○ Hexagon head, internal square form C 8 (5/16"), 1/2"

7204Z-516

Order-No.	○	○:	mm	📦
32547	5/16	1/2	38	5

Bit holder CentroFix Force mechanically lockable



○ 1/4", magnetic

7148 CF

Order-No.	○	●	mm	
39133	1/4	1/4	60	1

Bit holder CentroFix mechanically lockable



○ 1/4"

7148C

Order-No.	○	●	mm	
32477	1/4	1/4	60	10

Bit holder CentroFix Super Slim mechanically lockable



○ 1/4", magnetic

7148 CS

Order-No.	○	●	mm	
39134	1/4	1/4	66	1

Bit holder MagicFlip Force magnetic



○ with ring magnet, 1/4"

7123

Order-No.	○	●	mm	
36800	1/4	1/4	62	10

INFOBOX:
CentroFix Force



- CentroFix Force
- Suitable for all bits with 1/4" hex drive style C6.3 and E6.3.
- SelfLock: The bit is locked mechanically and held securely when inserted.
- EasyOut: When unlocked, the bit moves into the ideal removal position.

INFOBOX:
CentroFix SuperSlim



- Up to 30% reduced outer diameter compared to "conventional" quick release holders.
- Improved screw accessibility in confined holes.
- SelfLock: The bit is locked mechanically and held securely when inserted.
- EasyOut: When unlocked, the bit moves into the ideal removal position.

INFOBOX:
MagicFlip Force



- Facilitates the fastening of long wood screws.
- Optimal holding force thanks to extremely powerful Neodym ring magnet.
- FlipBack: The actuating sleeve automatically springs back during recessing.
- Magnet On/Off: The ring magnet can be "deactivated" by pushing the actuating sleeve back.

Bit holder CentroFix mechanically lockable



○ with stainless-steel shaft, 1/4"

7148ST

Order-No.	○	●	mm	
33765	1/4	1/4	60	5

Bit holder clamping with retaining ring



○ 1/4"

7140

Order-No.	○	●	mm	
01910	1/4	1/4	57	5

Bit holder magnetic, clamping with retaining ring



○ 1/4"

7143

Order-No.	○	●	mm	
01913	1/4	1/4	72	2
36092	1/4	1/4	100	5
34306	1/4	1/4	150	5
36093	1/4	1/4	200	5
36094	1/4	1/4	250	5

Bit holder magnetic, 74 mm



○ 1/4"

7113

Order-No.	○	●	mm	
01894	1/4	1/4	74	10

Bit holder magnetic, clamping with retaining ring



○ Copper beryllium 1/4"

7142

Order-No.	○	●	mm	
01912	1/4	1/4	73	2

Bit holder magnetic



○ extra strong magnet, 1/4"

7113 P

Order-No.	○	●	mm	
41922	1/4	1/4	60	10

Bit holder magnetic, 58 mm



○ 1/4"

7113 S

Order-No.	○	●	mm	
01895	1/4	1/4	58	10

○ 1/4" in blister pack

7113 S

Order-No.	○	●	mm	
07869	1/4	1/4	58	10

INFOBOX:
Drive systems and matching bits



Bit holder	suitable for
CentroFix Force	C 6.3, E 6.3 und 1/4" drives
CentroFix SuperSlim	C 6.3
MagicFlip Force	C 6,3

Universal holder, magnetic/ retaining ring, style G 7.



Order-No.	⌀	⌀	mm	
01919	1/4	G7	72	2

Industrial bit holder, with magnet, Halfmoon 4 mm.



Order-No.	⌀	mm	
36112	4	50	1

Screwdriver with bit holder SoftFinish® magnetic



Order-No.	⌀		mm	mm		
01475	1/4	125	225	36		10
01476	1/4	300	400	36		5

Screwdriver with bit holder SoftFinish® clamping with retaining ring



Order-No.	⌀		mm	mm		
01479	1/4	150	268	36		10

Screwdriver with bitholder, Quick-release holder



Order-No.	⌀		mm	mm		
25874	1/4	35	146	30		10

Screwdriver with SoftFinish® CentroFix bit holder, mechanically lockable



Order-No.	⌀		mm	mm		
40331	1/4	38	149	36		10

Screwdriver with bit holder SoftFinish® magnetic



Order-No.	⌀		mm		
32160	1/4	125	36		10

Screwdriver with bit holder SoftFinish® magnetic



Order-No.	⌀		mm		
29463	1/4	57	34		10

Screwdriver with bit holder SoftFinish® ESD, mechanically lockable



○ 1/4"

387ESD

Order-No.	○	⇄	mm	⇄	📦
32161	1/4	38	148	30	5

Handle: IEC 61340-5-1.

Screwdriver with T-handle and bit holder magnetic



○ 1/4"

388

Order-No.	○	⇄	⇄	📦
01481	1/4	150	80	10

Screwdriver with T-handle and two bit holders ComfortGrip magnetic



○ 1/4"

388DS

Order-No.	○	⇄	⇄	📦
26179	1/4	150	100	10

Screwdriver with bit holder SoftFinish® ESD



○ Stubby, 1/4"

281-01ESD

Order-No.	○	⇄	⇄	📦
32484	1/4	57	34	10

Handle: IEC 61340-5-1.

High-performance offset screwdriver with quick release holder 1/4"



○ 1/4" in blister pack

SB24628

Order-No.	○	●	⇄	max. Nm	📦
32310	1/4	1/4	165	57	1

Screwdriver handle ESD



○ for micro-bits 4 mm drive

2804

Order-No.	○	⇄	⇄	📦
40662	4,0	110	14	10

Offset screwdriver with bit holder 1/4", magnetic



○ 1/4" in blister pack

SB24629

Order-No.	○	●	⇄	max. Nm	📦
32311	1/4	1/4	130	14	1



Pliers

A cut above the rest for your health.

Wiha pliers combine high-quality materials with ergonomic comfort. Precise interaction between the joints and the exact workmanship of the blades and gripping surfaces ensure optimum functionality. Ergonomically designed and crafted to a high quality standard, they are comfortable to use, causing less body fatigue and thus making work more efficient.

The “OptiGrip” triple-point support design for combination and high-leverage combination pliers ensure an optimum, secure hold when handled. The circlip pliers from the Classic Series with their MagicTips® precision tips made of high-performance steel provide added safety and stability. With its angled plier shape, the Wiha Inomic® VDE product line is kind to the user's joints, muscles and tendons. Wiha also supplies suitable tools for stripping, skinning and crimping.

Application

Pliers

For applications in electrics



Installation pliers TriCut Professional electric
Page 253



BiCut® Professional electric high-performance diagonal cutters with DynamicJoint®, Switchable
Page 254



Diagonal cutters Professional electric with DynamicJoint®
Page 254



Combination pliers Professional electric with DynamicJoint® and OptiGrip
Page 256



Needle nose pliers Inomic® VDE with cutting edge and stripping points
Page 257



Needle nose pliers Professional electric with cutting edge straight shape
Page 258



Cable cutter Professional electric
Page 259



Water pump pliers Professional electric with push button adjustment
Page 260



Hacksaw electric
Page 262



Stripping tool automatic up to 16 mm² in blister pack
Page 262



Stripping tool with self-rotating trailing blade
Page 273



Automatic crimp tool for wire-end sleeves hex crimping
Page 265



For applications in mechanics



Professional BiCut® high-performance diagonal cutters with DynamicJoint® Switchable
Page 268



Diagonal cutters Professional with DynamicJoint®
Page 268



Combination pliers Professional with DynamicJoint® and OptiGrip
Page 270



Needle-nose pliers Professional with cutting edge straight shape
Page 271



Plastic diagonal cutters Classic with opening spring without bevelled edge
Page 273



Pliers wrench Classic
Page 275



Water pump pliers QuickFix Professional automatic automatic
Page 276



Circlip pliers Classic with MagicTips® for inner rings (holes), straight
Page 278



For applications in electronics



Pliers set Professional ESD, Diagonal cutters, oblique end cutting nippers, needle nose pliers 4-pcs.
Page 282



Needle nose pliers Professional ESD straight
Page 285



Needle nose pliers Electronic narrow, short head straight form
Page 287



Universal tweezers Professional ESD
Page 288



Pliers set Professional electric



Combination pliers, needle nose pliers, diagonal cutters 3-pcs.

Z 99 0 001 06

Order-No.



26852

1

Trimming / cutting

Diagonal cutters Professional electric with DynamicJoint®, Tool tested at 10,000 V AC / 160mm, 6 ½" (26741)

Supplying / holding

Combination pliers Professional electric with DynamicJoint® and OptiGrip with extra long cutting edge, Tool tested at 10,000 V AC / 180mm, 7" (26708)

Needle nose pliers Professional electric with cutting edge straight shape, Tool tested at 10,000 V AC / 200mm, 8" (26727)

Manufactured acc. to IEC 60900.

Pliers set Industrial electric



Combination pliers, needle nose pliers, diagonal cutters 3-pcs.

Z 99 0 001 09

Order-No.



38637

1

Trimming / cutting

Industrial electric diagonal cutters with DynamicJoint®, Tool tested at 10,000 V AC / 160mm, 6 ½" (33177)

Supplying / holding

Industrial electric combination pliers with DynamicJoint® and OptiGrip with extra long cutting edge, Tool tested at 10,000 V AC / 180mm, 7" (33186)

Industrial electric needle nose pliers with cutting edge straight shape, Tool tested at 10,000 V AC / 200mm, 8" (33178)

Manufactured acc. to IEC 60900.

INFOBOX:
Professional pliers
Industrial pliers



Professional

Industrial

- Professional: pliers, chrome-plated
- Industrial: pliers, polished/black oxidised



Installation pliers TriCut Professional electric



Z 14 1 06

Order-No.	mm	II	✂	Ømm	SB	📦
38552	170	7	13	1.6		5
38853	170	7	13	1.6	x	5

Manufactured acc. to IEC 60900.

Installation pliers TriCut Classic



Z 14 1 01

Order-No.	mm	II	✂	Ømm	SB	📦
38627	170	7	13	1.6		5
38854	170	7	13	1.6	x	5

INFOBOX: VDE-certified tools



Wiha VDE-tested tools are subject to stringent safety test procedures.

All tools with the special marking have been tested at 10,000 V AC and are therefore approved for use at 1,000 V AC and 1,500 V DC.

The following equipment is required for all work on or around live components and should be appropriate for the specific task

- insulating personal protective equipment
- insulating safety mechanisms
- insulated tools

Before starting work, you must disconnect all active, live components of electrical machines and equipment and ensure that they remain disconnected while you carry out the work.

This is achieved by complying with the five safety rules:

- disconnect
- secure against reconnection
- ensure power is switched off
- earth and short-circuit
- cover or block off adjacent live components

Certified by the VDE Testing and Certification Institute and individually tested according to the international standard IEC 60900.

Stripping diagonal cutters Professional electric with DynamicJoint®



Z 14 0 06

Order-No.	mm	II	✂	Ømm	SB	📦
26745	160	6 ½	13	1.6		5
27431	160	6 ½	13	1.6	x	5

DIN ISO 5749. Manufactured acc. to IEC 60900.

BiCut® Professional electric high-performance diagonal cutters with DynamicJoint®

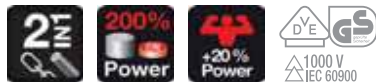

Switchable

Z 18 0 06

Order-No.	mm	II	✂	Ømm	SB	📦
38191	200	8	21	3		5
38984	200	8	21	3	x	5

Manufactured acc. to IEC 60900.

Diagonal cutters Professional electric with DynamicJoint®



Z 12 0 06

Order-No.	mm	II	✂	Ømm	SB	📦
26737	140	5 ½	16	1.4		5
27428	140	5 ½	16	1.4	x	5
26741	160	6 ½	16	1.6		5
27429	160	6 ½	16	1.6	x	5
26744	180	7	17	1.8		5
27430	180	7	17	1.8	x	5

DIN ISO 5749. Manufactured acc. to IEC 60900.

Industrial electric diagonal cutters with DynamicJoint®



Z 12 0 09

Order-No.	mm	II	✂	Ømm	SB	📦
38633	140	5 ½	16	1.4		5
38860	140	5 ½	16	1.4	x	5
33177	160	6 ½	16	1.6		5
38861	160	6 ½	16	1.6	x	5

DIN ISO 5749. Manufactured acc. to IEC 60900.

INFOBOX:
DynamicJoint®



Wiha DynamicJoint® – A new dimension in strength and durability

- Innovative: Optimised joint construction.
- Effective: Minimal power loss means less force needed for cutting.
- Permanent: Optimal performance even after thousands of cuts.

Heavy-duty diagonal cutters Professional electric with DynamicJoint®



with switchable opening spring

Z 16 3 06

Order-No.	mm	mm	mm	mm	SB	
40921	160	6,5	17	2		5
41309	160	6,5	17	2	x	5
41274	180	7	18	2,3		5
41319	180	7	18	2,3	x	5
41279	200	8	19	2,5		5
41329	200	8	19	2,5	x	5

DIN ISO 5749. Manufactured acc. to IEC 60900.

Industrial electric heavy-duty diagonal cutters with DynamicJoint®



with switchable opening spring

Z 16 3 09

Order-No.	mm	mm	mm	mm	SB	
40922	160	6,5	17	2		5
41310	160	6,5	17	2	x	5
41275	180	7	18	2,3		5
41320	180	7	18	2,3	x	5
41280	200	8	19	2,5		5
41330	200	8	19	2,5	x	5

DIN ISO 5749. Manufactured acc. to IEC 60900.

INFOBOX:

Heavy-duty diagonal cutters with switchable opening spring



- Up to 40% more cutting force thanks to optimised leverage.
- Opening spring with on/off function for fatigue-free work.
- Opening spring can be activated with just one hand.



Combination pliers Professional electric with DynamicJoint® and OptiGrip



with extra long cutting edge

Z 01 0 06

Order-No.	mm	II	✂	Ømm	SB	📦
26705	160	6 ½	16	1.6		5
27328	160	6 ½	16	1.6	x	5
26708	180	7	16	1.8		5
27418	180	7	16	1.8	x	5
26711	200	8	17	2		5
27419	200	8	17	2	x	5

DIN ISO 5746. Manufactured acc. to IEC 60900.

High-leverage combination pliers Professional electric with DynamicJoint® and OptiGrip



with extra long cutting edge

Z 02 0 06

Order-No.	mm	II	✂	Ømm	SB	📦
26714	200	8	18	2.3		5
27420	200	8	18	2.3	x	5
26717	225	9	19	2.5		5
27421	225	9	19	2.5	x	5

DIN ISO 5746. Manufactured acc. to IEC 60900.

Industrial electric combination pliers with DynamicJoint® and OptiGrip



with extra long cutting edge

Z 01 0 09

Order-No.	mm	II	✂	Ømm	SB	📦
33186	180	7	16	1.8		5
38855	180	7	16	1.8	x	5

DIN ISO 5746. Manufactured acc. to IEC 60900.

High-leverage industrial electric combination pliers with DynamicJoint® and OptiGrip



Z 02 0 09

Order-No.	mm	II	✂	Ømm	SB	📦
35465	225	9	19	2.5		5
38856	225	9	19	2.5	x	5

DIN ISO 5746. Manufactured acc. to IEC 60900.

INFOBOX:
OptiGrip



Wiha OptiGrip – optimal grip due to newly designed gripping surfaces

- A firm hold: The „triple-point support“ protects the workpiece from twisting or slipping.
- Highly effective: Optimum grip even with large jaw opening – and at the same time significantly less force needed.
- A wide selection: Now in standard Wiha combination pliers and high leverage combination pliers.

Industrial lineman's pliers with DynamicJoint®



with extra long cutting edge

Z 02 2 02

Order-No.	mm	mm	mm	mm	SB	
40927	250	10	20	2.5		5
41219	250	10	20	2.5	x	5

Classic lineman's pliers with DynamicJoint®



with extra long cutting edge

Z 02 2 01

Order-No.	mm	mm	mm	mm	SB	
40709	250	10	20	2.5		5
41218	250	10	20	2.5	x	5

Inomic® electric combination pliers



Z 01 0 16

Order-No.	Typ	mm	mm	
33261	180	12	1.6	5

Manufactured acc. to IEC 60900.

Needle nose pliers Inomic® VDE



Z 06 0 16

Order-No.	Typ	mm	mm	
33259	160	12	1,6	5

Manufactured acc. to IEC 60900.

INFOBOX: Wiha Inomic®



Innovative and ergonomic.

- The angled shape of the Inomic® pliers enables work which is kind on the hands and muscles and is therefore recommended by doctors and therapists from the AGR.
- Improved grip control due to highly sensitive opening spring.
- Like an extension of your own hand: gripping is simple, firm and safe.
- Pliers can be transported and stored in a closed position, thanks to a locking mechanism.



Needle nose pliers Professional electric



with cutting edge straight shape

Z 05 0 06

Order-No.	mm	II	✂	Ømm	SB	📦
26720	160	6 1/2	16	1.2		5
27422	160	6 1/2	16	1.2	x	5
26727	200	8	17	1.6		5
27423	200	8	17	1.6	x	5

DIN ISO 5745. Manufactured acc. to IEC 60900.

Needle nose pliers Professional electric



with cutting edge curved shape, approx. 40°

Z 05 1 06

Order-No.	mm	II	✂	Ømm	SB	📦
26728	160	6 1/2	16	1.2		5
27424	160	6 1/2	16	1.2	x	5
26729	200	8	17	1.6		5
27425	200	8	17	1.6	x	5

DIN ISO 5745. Manufactured acc. to IEC 60900.

Industrial electric needle nose pliers



with cutting edge straight shape

Z 05 0 09

Order-No.	mm	II	✂	Ømm	SB	📦
35477	160	6 1/2	16	1.2		5
38857	160	6 1/2	16	1.2	x	5
33178	200	8	17	1.6		5
38858	200	8	17	1.6	x	1

DIN ISO 5745. Manufactured acc. to IEC 60900.

Industrial electric needle nose pliers



with cutting edge curved shape, approx. 40°

Z 05 1 09

Order-No.	mm	II	✂	Ømm	SB	📦
35462	200	8	17	1.6		5
38859	200	8	17	1.6	x	5

DIN ISO 5745. Manufactured acc. to IEC 60900.

Long flat-nose pliers Professional electric



Z 07 0 06

Order-No.	mm	II	SB	
26732	160	6 1/2		5
27426	160	6 1/2	x	5

DIN ISO 5745. Manufactured acc. to IEC 60900.

Cable cutter Professional electric



Z 50 1 06

Order-No.	mm	II	SB	mm ²	SB		
34743	160	6 1/2		16	50	5	
35704	160	6 1/2		16	50	x	5
34744	200	8		20	60		5
35705	200	8		20	60	x	5

Manufactured acc. to IEC 60900.

Long round-nose pliers Professional electric



Z 09 0 06

Order-No.	mm	II	SB	
26735	160	6 1/2		5
27427	160	6 1/2	x	5

DIN ISO 5745. Manufactured acc. to IEC 60900.

Industrial electric cable cutter



Z 50 1 09

Order-No.	mm	II	SB	mm ²	SB		
38636	160	6 1/2		16	50	5	
38865	160	6 1/2		16	50	x	5
35479	200	8		20	60		5
38866	200	8		20	60	x	5

Manufactured acc. to IEC 60900.



Cable cutter Classic



Z 50 1 01

Order-No.	mm	II	✂	mm ²	SB	
34729	160	6 1/2	16	50		5
36217	160	6 1/2	16	50	x	5
34730	200	8	20	60		5
36981	200	8	20	60	x	5

Stripping pliers Professional electric



Z 55 0 06

Order-No.	mm	II	Ø	mm ²	SB	
26847	160	6 1/2	5	10		5
27437	160	6 1/2	5	10	x	5

DIN ISO 5743. Manufactured acc. to IEC 60900.

Water pump pliers Professional electric



box type

Z 21 0 06

Order-No.	mm	II	○	○	SB	
33520	250	10	2	50		5
38631	250	10	2	50	x	5

DIN ISO 8976. Manufactured acc. to IEC 60900.

Industrial electric stripping pliers



Z 55 0 09

Order-No.	mm	II	Ø	mm ²	SB	
36711	160	6 1/2	5	10		5
38867	160	6 1/2	5	10	x	5

DIN ISO 5743. Manufactured acc. to IEC 60900.

Water pump pliers Professional electric



with push button adjustment

Z 22 0 06

Order-No.	mm	II	○	○	SB	
37450	250	10	2	50		5
38632	250	10	2	50	x	5

DIN ISO 8976. Manufactured acc. to IEC 60900.

Stripping pliers Professional



Z 55 0 05

Order-No.	mm	II	Ø	mm ²	SB	
26846	160	6 ½	5	10		5
27417	160	6 ½	5	10	x	5

DIN ISO 5743.

Stripping pliers Classic



Z 55 0 01

Order-No.	mm	II	Ø	mm ²	SB	
26845	160	6 ½	5	10		5
27368	160	6 ½	5	10	x	5

DIN ISO 5743.

Stripping pliers Industrial



Z 55 0 02

Order-No.	mm	II	Ø	mm ²	SB	
32345	160	6 ½	5	10		5
34313	160	6 ½	5	10	x	5

DIN ISO 5743.



Stripping tool automatic



up to 16 mm² in blister pack

Z 57 0 06 SB

Order-No.	mm	II	mm ²	AWG	SB	
42062	200	8	0,03 - 16	32-5	x	1

Stripping tool automatic

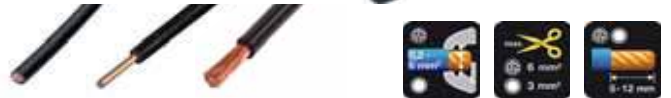

up to 6 mm² in blister pack

246 75 SB

Order-No.	mm	II	mm ²	AWG	SB	
36050	190	7 ½	0,2-6,0	24-10	x	1

Spare blade and gripping jaw set

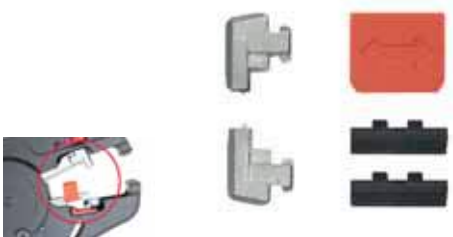

for automatic stripping tool

Z 57 0 001 06K

Order-No.	
42162	1

Hacksaw electric



insulated with three saw blades 150 mm

SB246176

Order-No.		mm	SB	
43125	150	280	x	1

INFOBOX: Stripping tool, automatic up to 16mm²



- These pliers can handle a wide range of cables, thus combining two pairs of pliers in one.
- The supplied damper can be used to lessen recoil caused by larger cable gauges, such as those greater than 6 mm², thus helping to protect wrists.
- Precise cutting to length thanks to adjustable longitudinal stop.
- Integrated hand protection along the cutting edge guards against injury.



Stripping tool



with self-rotating trailing blade

246 22 02

Order-No.	mm	II	Ø mm	SB	
35969	165	6½	4,0-28		1
35538	165	6½	4,0-28	x	1

Stripping tool



for round cable, in blister pack

246 77 SB

Order-No.	mm	II	mm²	SB	
36052	125	5	8-13	x	1

Cable stripping knife



straight cutting edge for round cables in blister pack

246 80 SB

Order-No.	mm	II	SB	
38798	200	8	x	1

Manufactured acc. to IEC 60900.

Stripping tool



for coaxial cable, in blister pack

246 76 SB

Order-No.	mm	II	mm²	SB	
36051	110	4¼	4,8-7,5	x	1

Cable stripping knife



hooked blade with sliding shoe for round cable, in blister pack

246 78 SB

Order-No.	mm	II	SB	
36053	200	8	x	1

Manufactured acc. to IEC 60900.



Crimping pliers Classic



Z 60 0 01

Order-No.	mm	II	mm ²	
28330	145	5 3/4	0,25-2,5	5

DIN ISO 5743.

Crimping pliers Professional electric



Z 60 0 06

Order-No.	mm	II	mm ²	SB	
35861	145	5 3/4	0,25-2,5		5
38985	145	5 3/4	0,25-2,5	x	5

DIN ISO 5743. Manufactured acc. to IEC 60900.

Crimping pliers Classic



Z 60 0 01

Order-No.	mm	II	mm ²	
30066	180	7	0,25-16	5

DIN ISO 5743.

Crimping pliers Professional electric



Z 60 0 06

Order-No.	mm	II	mm ²	SB	
35862	180	7	0,25-16		5
38986	180	7	0,25-16	x	5

DIN ISO 5743. Manufactured acc. to IEC 60900.

Automatic crimp tool



for wire-end sleeves hex crimping

Z 62 0 005 06 SB

Order-No.	mm	mm ²	AWG	
41246	210	0,08-16	28-5	1

For processing twin sleeves and wire-end sleeves with or without insulating collar as per DIN 46228 & EN 50027

Crimp tool



for insulated cable eyes and contacts

Z 62 0 002 06

Order-No.	mm	mm ²	AWG	
33841	220	0,5-6	20-10	1

For processing of red, blue and yellow isolated cable eyes, pin-end cable connectors, contact pins, contact pin sleeves, circular pins, circular pin sleeves, batch connectors and parallel connectors according to DIN 46234.

Crimp tool



for wire-end sleeves

Z 62 0 001 06

Order-No.	mm	mm ²	AWG	SB	
33844	220	0,14-16	26-5		1
40342	220	0,14-16	26-5	x	1

For processing of wire-end sleeves with and without isolating collar according to DIN 46228, EN 50027.

Crimp tool



for non-insulated cable eye with closed sleeve

Z 62 0 004 06

Order-No.	mm	mm ²	AWG	
33843	220	0,1-16	26-6	1

For processing of non-insulated cable eyes, pin-end cable connectors, batch connectors and mini cable eyes according to DIN 46234/ DIN 46230/ DIN 46341.

Crimp tool



for non-insulated male blade connectors

Z 62 0 003 06

Order-No.	mm	mm ²	AWG	
33842	220	0,25-6	24-10	1

For processing of non-insulated contact pins and contact pin sleeves according to DIN 46247 for standardised, solderless electrical connections.

INFOBOX: Automatic crimp tool



- Process-safe hexagonal crimping prevents smaller wire-end sleeves from snagging.
- These crimping pliers can handle all standard applications with a crimping range between 0.08 and 16 mm².
- Suitable for both single wire-end sleeves and twin wire-end sleeves thanks to automatic crimping.

Shear for electricians



with crimp function in blister pack

Z 71 7 160 06 SB

Order-No.	mm	mm ²	
41923	160	50	5

Pliers set Classic



Combination pliers, needle nose pliers, diagonal cutters 3-pcs.

Z 99 0 001 01

Order-No.	
26850	1

Combination pliers Classic with DynamicJoint® and OptiGrip with extra long cutting edge 180mm, 7" (26706)

Diagonal cutters Classic 160mm, 6 1/2" (26739)

Classic needle nose pliers with cutting edge straight shape 160mm, 6 1/2" (26718)

Craftsman's cutters



Standard model made of stainless steel

Z 71 5 06

Order-No.	mm	mm	
29420	145	5 3/4	5

Pliers set Classic



High-leverage combination pliers, water pump pliers, heavy-duty diagonal cutters, 3-pcs.

Z 99 0 002 01

Order-No.	
26853	1

High-leverage combination pliers Classic with DynamicJoint® and OptiGrip with extra long cutting edge 200mm, 8" (26712)

Heavy-duty diagonal cutters Classic with DynamicJoint® 180mm, 7" (41261)

Water pump pliers QuickFix Classic automatic 250mm, 10" (39091)

Pliers set Professional



High-leverage combination pliers, water pump pliers, heavy-duty diagonal cutters, 3-pcs.

Z 99 0 002 05

Order-No. 1
26854

High-leverage combination pliers Professional with DynamicJoint® and OptiGrip with extra long cutting edge 200mm, 8" (26713)

Heavy-duty diagonal cutters Professional with DynamicJoint® with switchable opening spring 180mm, 7" (41273)

Water pump pliers QuickFix Professional automatic automatic 250mm, 10" (39093)

Pliers set Classic with MagicTips®



Circlip pliers 4-pcs.

Z 99 0 007 01

Order-No. 1
34708

Supplying / holding

⊖ Circlip pliers Classic with MagicTips® for inner rings (holes), straight J 1, 140mm (34689) / J 2, 180mm (34690)

⊖ Circlip pliers Classic with MagicTips® for outer rings (shafts), straight A 1, 140mm (34699) / A 2, 185mm (34700)

• with safety latching function

Pliers set Classic



Circlip pliers 4-pcs.

Z 99 0 004 01

Order-No. 1
26793

⊖ Classic circlip pliers for inner rings (holes), straight J 1, 140mm (26782) / J 2, 180mm (26783)

⊖ Classic circlip pliers for outer rings (shafts), straight A 1, 140mm (26790) / A 2, 180mm (26791)

INFOBOX:
MagicTips®



Wiha MagicTips® – Top of their class.

- Maximum grip: The special latching function preventing jumping away of the safety rings makes the Wiha circlip pliers truly unique.
- Hard as steel: Additional hardening of tips means high wear resistance and therefore excellent durability.
- Precise: Precision tips of high performance steel for maximum grip and high stability.



Professional BiCut® high-performance diagonal cutters with DynamicJoint®



Switchable

Z 18 0 05

Order-No.	mm	II	✂	Ømm	SB	📦
38190	200	8	21	3		5
38983	200	8	21	3	x	1

Based on DIN ISO 5749.

High-performance diagonal cutters BiCut® Industrial with DynamicJoint®



Switchable

Z 18 0 02

Order-No.	mm	II	✂	Ømm	SB	📦
38189	200	8	21	3		5
38982	200	8	21	3	x	5

Based on DIN ISO 5749.

BiCut® Classic high-performance diagonal cutters with DynamicJoint®



Switchable

Z 18 0 01

Order-No.	mm	II	✂	Ømm	SB	📦
38060	200	8	21	3		5
38981	200	8	21	3	x	5

Based on DIN ISO 5749.

Diagonal cutters Professional with DynamicJoint®



Z 12 0 05

Order-No.	mm	II	✂	Ømm	SB	📦
26736	140	5 ½	16	1.4		5
27409	140	5 ½	16	1.4	x	5
26740	160	6 ½	16	1.6		5
27507	160	6 ½	16	1.6	x	5
26743	180	7	17	1.8		5
27410	180	7	17	1.8	x	5

DIN ISO 5749.

Diagonal cutters Industrial with DynamicJoint®



Z 12 0 02

Order-No.	mm	II	✂	Ømm	SB	📦
30975	140	5 ½	16	1.4		5
34311	140	5 ½	16	1.4	x	5
30827	160	6 ½	16	1.6		5
34516	160	6 ½	16	1.6	x	5
30976	180	7	17	1.8		5
34571	180	7	17	1.8	x	5

DIN ISO 5749.

Diagonal cutters Classic



Z 12 0 01

Order-No.	mm	II	✂	Ømm	SB	📦
26738	140	5 ½	16	1.4		5
27346	140	5 ½	16	1.4	x	5
26739	160	6 ½	16	1.6		5
27347	160	6 ½	16	1.6	x	5
26742	180	7	17	1.8		5
27348	180	7	17	1.8	x	5

DIN ISO 5749.

Heavy-duty diagonal cutters Industrial with DynamicJoint®



Z 16 3 02

with switchable opening spring

Order-No.	mm	II	✂	Ømm	SB	📦
40919	160	6,5	17	2		5
41307	160	6,5	17	2	x	5
41272	180	7	18	2,3		5
41317	180	7	18	2,3	x	5
41277	200	8	19	2,5		5
41327	200	8	19	2,5	x	5

Heavy-duty diagonal cutters Professional with DynamicJoint®



Z 16 3 05

with switchable opening spring

Order-No.	mm	II	✂	Ømm	SB	📦
40920	160	6,5	17	2		5
41308	160	6,5	17	2	x	5
41273	180	7	18	2,3		5
41318	180	7	18	2,3	x	5
41278	200	8	19	2,5		5
41328	200	8	19	2,5	x	5

Heavy-duty diagonal cutters Classic with DynamicJoint®



Z 16 2 01

Order-No.	mm	II	✂	Ømm	SB	📦
40913	160	6,5	17	2		5
41301	160	6,5	17	2	x	5
41261	180	7	18	2,3		5
41311	180	7	18	2,3	x	5
41266	200	8	19	2,5		5
41321	200	8	19	2,5	x	5

INFOBOX: Heavy-duty diagonal cutters with switchable opening spring



- Up to 40% more cutting force thanks to optimised leverage.
- Opening spring with on/off function for fatigue-free work.
- Opening spring can be activated with just one hand.



Combination pliers Professional with DynamicJoint® and OptiGrip



with extra long cutting edge

Z 01 0 05

Order-No.	mm	II	✂	Ømm	SB	
26704	160	6 ½	16	1.6		5
27327	160	6 ½	16	1.6	x	5
26707	180	7	16	1.8		5
27399	180	7	16	1.8	x	5
26710	200	8	17	2		5
27400	200	8	17	2	x	5

DIN ISO 5746.

Combination pliers Classic with DynamicJoint® and OptiGrip



with extra long cutting edge

Z 01 0 01

Order-No.	mm	II	✂	Ømm	SB	
26703	160	6 ½	16	1.6		5
27325	160	6 ½	16	1.6	x	5
26706	180	7	16	1.8		5
27336	180	7	16	1.8	x	5
26709	200	8	17	2		5
27337	200	8	17	2	x	5

DIN ISO 5746.

Combination pliers Industrial with DynamicJoint® and OptiGrip



with extra long cutting edge

Z 01 0 02

Order-No.	mm	II	✂	Ømm	SB	
30979	160	6 ½	16	1.6		5
34565	160	6 ½	16	1.6	x	5
30826	180	7	16	1.8		5
34307	180	7	16	1.8	x	5
30978	200	8	17	2		5
34308	200	8	17	2	x	5

DIN ISO 5746.

INFOBOX:
DynamicJoint®



Wiha DynamicJoint® – A new dimension in strength and durability

- Innovative: Optimised joint construction.
- Effective: Minimal power loss means less force needed for cutting.
- Permanent: Optimal performance even after thousands of cuts.

High-leverage combination pliers Professional with DynamicJoint® and OptiGrip



with extra long cutting edge

Z 02 0 05

Order-No.	mm	II	✂	Ømm	SB	📦
26713	200	8	18	2.3		5
27401	200	8	18	2.3	x	5
26716	225	9	19	2.5		5
27402	225	9	19	2.5	x	5

DIN ISO 5746.

High-leverage combination pliers Classic with DynamicJoint® and OptiGrip



with extra long cutting edge

Z 02 0 01

Order-No.	mm	II	✂	Ømm	SB	📦
26712	200	8	18	2.3		5
27338	200	8	18	2.3	x	5
26715	225	9	19	2.5		5
27339	225	9	19	2.5	x	5

DIN ISO 5746.

High-leverage combination pliers Industrial with DynamicJoint® and OptiGrip



with extra long cutting edge

Z 02 0 02

Order-No.	mm	II	✂	Ømm	SB	📦
32319	200	8	18	2.3		5
34566	200	8	18	2.3	x	5
32320	225	9	19	2.5		5
34567	225	9	19	2.5	x	5

DIN ISO 5746.

Needle-nose pliers Professional



with cutting edge straight shape

Z 05 0 05

Order-No.	mm	II	✂	Ømm	SB	📦
26719	160	6 ½	16	1.2		5
27403	160	6 ½	16	1.2	x	5
26722	200	8	17	1.6		5
27404	200	8	17	1.6	x	5

DIN ISO 5745.

INFOBOX:
OptiGrip



Wiha OptiGrip – optimal grip due to newly designed gripping surfaces

- A firm hold: The „triple-point support“ protects the workpiece from twisting or slipping.
- Highly effective: Optimum grip even with large jaw opening – and at the same time significantly less force needed.
- A wide selection: Now in standard Wiha combination pliers and high leverage combination pliers.

Industrial needle nose pliers



with cutting edge straight shape

Z 05 0 02

Order-No.	mm	II	✂	Ømm	SB	📦
32322	160	6 ½	16	1.2		5
34309	160	6 ½	16	1.2	x	5
32323	200	8	17	1.6		5
34515	200	8	17	1.6	x	5

DIN ISO 5745.

Needle-nose pliers Professional



with cutting edge curved shape, approx. 40°

Z 05 1 05

Order-No.	mm	II	✂	Ømm	SB	📦
26724	160	6 ½	16	1.2		5
27405	160	6 ½	16	1.2	x	5
26726	200	8	17	1.6		5
27406	200	8	17	1.6	x	5

DIN ISO 5745.

Classic needle nose pliers



with cutting edge straight shape

Z 05 0 01

Order-No.	mm	II	✂	Ømm	SB	📦
26718	160	6 ½	16	1.2		5
27340	160	6 ½	16	1.2	x	5
26721	200	8	17	1.6		5
27341	200	8	17	1.6	x	5

DIN ISO 5745.

Industrial needle nose pliers



with cutting edge curved shape, approx. 40°

Z 05 1 02

Order-No.	mm	II	✂	Ømm	SB	📦
32324	160	6 ½	16	1.2		5
34569	160	6 ½	16	1.2	x	5
32328	200	8	17	1.6		5
34570	200	8	17	1.6	x	5

DIN ISO 5745.

Classic needle nose pliers



with cutting edge curved shape, approx. 40°

Z 05 1 01

Order-No.	mm	II	✂	Ømm	SB	📦
26723	160	6 ½	16	1.2		5
27342	160	6 ½	16	1.2	x	5
26725	200	8	17	1.6		5
27343	200	8	17	1.6	x	5

DIN ISO 5745.

Classic precision mechanic's needle nose pliers



with cutting edge and opening spring in straight shape

Z 36 0 01

Order-No.	mm	II	✂	Ømm	📦
36483	160	6 ½	10	2	5

DIN ISO 5745.

Plastic diagonal cutters Classic



with opening spring without bevelled edge

Z 15 0 01

Order-No.	mm	II	✂	📦
37402	125	5	2	5
37403	160	6 ½	3	5

DIN ISO 5743.

Precision mechanic's diagonal cutters Classic



with opening spring

Z 44 3 01

Order-No.	mm	II	✂	Ømm	SB	📦
36189	125	5	7	0.8		5
43240	125	5	7	0,8	x	5

DIN ISO 5749.



Long flat-nose pliers Professional



Z 07 0 05

Order-No.	mm	II	SB	
26731	160	6 ½		5
27407	160	6 ½	x	5

DIN ISO 5745.

Long round-nose pliers Professional



Z 09 0 05

Order-No.	mm	II	SB	
26734	160	6 ½		5
27408	160	6 ½	x	5

DIN ISO 5745.

Long flat-nose pliers Industrial



Z 07 0 02

Order-No.	mm	II	SB	
32330	160	6 ½		5
34310	160	6 ½	x	5

DIN ISO 5745.

Long round-nose pliers Industrial



Z 09 0 02

Order-No.	mm	II	SB	
32332	160	6 ½		5
34568	160	6 ½	x	5

DIN ISO 5745.

Long flat-nose pliers Classic



Z 07 0 01

Order-No.	mm	II	SB	
26730	160	6 ½		5
27344	160	6 ½	x	5

DIN ISO 5745.

Long round-nose pliers Classic



Z 09 0 01

Order-No.	mm	II	SB	
26733	160	6 ½		5
27345	160	6 ½	x	5

DIN ISO 5745.

Pliers wrench Classic



Z 25 0 01

Order-No.	mm	II	⊙:	⊙:	
40923	250	10	46		6

Water pump pliers Industrial



box type

Z 21 0 02

Order-No.	mm	II	⊙:	⊙:	SB	
36038	180	7	1	30		5
36985	180	7	1	30	x	5
32342	250	10	2	50		5
34312	250	10	2	50	x	5
36039	300	12	2 ½	63		5
36986	300	12	2 ½	63	x	5

DIN ISO 8976.

Water pump pliers Professional



box type

Z 21 0 05

Order-No.	mm	II	⊙:	⊙:	SB	
26762	250	10	2	50		5
27414	250	10	2	50	x	5

DIN ISO 8976.

Water pump pliers Classic



box type

Z 21 0 01

Order-No.	mm	II	⊙:	⊙:	SB	
26760	180	7	1	30		5
27350	180	7	1	30	x	5
26761	250	10	2	50		5
27381	250	10	2	50	x	5
26763	300	12	2 ½	63		5
27382	300	12	2 ½	63	x	5

DIN ISO 8976.

INFOBOX: Plier wrench



- Required width setting directly on the work piece with no need to press any buttons
- Ratchet principle allows users to fasten screws rapidly with a simple glide.
- Thanks to its slim design and button-free setting, it is ideal for use in tight spaces.
- Smooth, parallel-acting jaws prevent damage on sensitive surfaces.



Water pump pliers Professional



with push button

Z 22 0 05

Order-No.	mm	II	O:	Ø:	SB	
26766	250	10	2	50		5
27415	250	10	2	50	x	5

DIN ISO 8976.

Water pump pliers QuickFix Professional automatic



automatic

Z 23 1 05

Order-No.	mm	II	O:	Ø:	SB	
39093	250	10	1 ½	40		1
39095	250	10	1 ½	40	x	5

DIN ISO 8976.

Water pump pliers Industrial



with push button

Z 22 0 02

Order-No.	mm	II	O:	Ø:	SB	
36040	180	7	1	30		5
36987	180	7	1	30	x	1
32352	250	10	2	50		5
34518	250	10	2	50	x	5
36041	300	12	2 ½	63		5
36988	300	12	2 ½	63	x	5

DIN ISO 8976.

Water pump pliers QuickFix Classic



automatic

Z 23 1 01

Order-No.	mm	II	O:	Ø:	SB	
39091	250	10	1 ½	40		1
39094	250	10	1 ½	40	x	5

DIN ISO 8976.

Water pump pliers Classic



with push button

Z 22 0 01

Order-No.	mm	II	O:	Ø:	SB	
26764	180	7	1	30		5
27351	180	7	1	30	x	5
26765	250	10	2	50		5
27383	250	10	2	50	x	5
26767	300	12	2 ½	63		5
27384	300	12	2 ½	63	x	5

DIN ISO 8976.

Heavy-duty end cutting nippers Classic



Z 17 0 01

Order-No.	mm	II		Ømm	SB	
26757	160	6 ½	16	1.6		5
27372	160	6 ½	16	1.6	x	5
26758	180	7	17	1.8		5
27373	180	7	17	1.8	x	5
26759	200	8	18	2		5
27374	200	8	18	2	x	5

DIN ISO 5748.

Pincers Classic



Z 30 0 01

Order-No.	mm	II	✂	Ømm	SB	📦
26771	180	7	12	2		5
27375	180	7	12	2	x	5
26772	200	8	13	2.2		5
27376	200	8	13	2.2	x	5

DIN ISO 9243.

Heavy-duty Classic Monier pliers



Z 32 0 01

Order-No.	mm	II	✂	Ømm	SB	📦
40712	300	12	19	2.3		5
41220	300	12	19	2.3	x	5

Monier pliers Classic



Z 31 0 01

Order-No.	mm	II	✂	Ømm	SB	📦
26774	220	8 3/4	16	1.6		5
27377	220	8 3/4	16	1.6	x	5
26776	250	10	17	1.8		5
27378	250	10	17	1.8	x	5
26778	280	11	18	2		5
27379	280	11	18	2	x	5
26780	300	12	18	2		5
27380	300	12	18	2	x	5

DIN ISO 9242.

Heavy-duty Classic Plus Monier pliers



without handle cover

Z 32 0 10

Order-No.	mm	II	✂	Ømm	SB	📦
40713	300	12	19	2.3		5
41221	300	12	19	2.3	x	5

Monier pliers Classic



without handle cover

Z 31 0 00

Order-No.	mm	II	✂	Ømm	SB	📦
26773	220	8 3/4	16	1.6		5
27501	220	8 3/4	16	1.6	x	5
26775	250	10	17	1.8		5
27502	250	10	17	1.8	x	5
26777	280	11	18	2		5
27503	280	11	18	2	x	5
26779	300	12	18	2		5
27504	300	12	18	2	x	5

DIN ISO 9242.



Circlip pliers Classic with MagicTips®



for inner rings (holes), straight

Z 33 4 01

Order-No.	Typ	mm	II	⊙	SB	📦
34688	J 0	140	5 ½	8-13		5
36975	J 0	140	5 ½	8-13	x	5
34689	J 1	140	5 ½	12-25		5
36225	J 1	140	5 ½	12-25	x	5
34690	J 2•	180	7	19-60		5
36222	J 2•	180	7	19-60	x	5
34691	J 3•	220	9	40-100		5
36272	J 3•	220	9	40-100	x	5
34692	J 4•	305	12	85-140		5

• with safety latching function DIN ISO 5256.

Circlip pliers Classic with MagicTips®



for outer rings (shafts), straight

Z 34 4 01

Order-No.	Typ	mm	II	⊙	SB	📦
34698	A 0	140	5 ½	7-10		5
36977	A 0	140	5 ½	7-10	x	5
34699	A 1	140	5 ½	10-25		5
36978	A 1	140	5 ½	10-25	x	5
34700	A 2•	185	7	19-60		5
36220	A 2•	185	7	19-60	x	5
34701	A 3•	240	9	40-100		5
36219	A 3•	240	9	40-100	x	5
34702	A 4•	300	12	85-140		5

• with safety latching function DIN ISO 5254.

Circlip pliers Classic with MagicTips®



for inner rings (holes) with angled shape

Z 33 5 01

Order-No.	Typ	mm	II	⊙	SB	📦
34693	J 01	140	5 ½	8-13		5
36976	J 01	140	5 ½	8-13	x	5
34694	J 11	140	5 ½	12-25		5
36223	J 11	140	5 ½	12-25	x	5
34695	J 21•	180	7	19-60		5
36224	J 21•	180	7	19-60	x	5
34696	J 31•	220	9	40-100		5
36226	J 31•	220	9	40-100	x	5
34697	J 41•	305	12	85-140		5

• with safety latching function DIN ISO 5256.

Circlip pliers Classic with MagicTips®



for outer rings (shafts), angled

Z 34 5 01

Order-No.	Typ	mm	II	⊙	SB	📦
34703	A 01	140	5 ½	7-10		5
36979	A 01	140	5 ½	7-10	x	5
34704	A 11	140	5 ½	10-25		5
36980	A 11	140	5 ½	10-25	x	1
34705	A 21•	185	7	19-60		5
36218	A 21•	185	7	19-60	x	1
34706	A 31•	240	9	40-100		5
36221	A 31•	240	9	40-100	x	5
34707	A 41•	300	12	85-140		5

• with safety latching function DIN ISO 5254.

Classic circlip pliers



for inner rings (holes), straight

Z 33 0 01

Order-No.	Typ	mm	II	☉	SB	
26781	J 0	139	5 ½	8-13		5
27352	J 0	139	5 ½	8-13	x	5
26782	J 1	140	5 ½	12-25		5
27353	J 1	140	5 ½	12-25	x	5
26783	J 2	180	7	19-60		5
27354	J 2	180	7	19-60	x	5
26784	J 3	225	9	40-100		5
27355	J 3	225	9	40-100	x	5
29425	J 4	310	12	85-140		5
39027	J 4	310	12	85-140	x	5

DIN ISO 5256.

Classic circlip pliers



for outer rings (shafts), straight

Z 34 0 01

Order-No.	Typ	mm	II	☉	SB	
26789	A 0	139	5 ½	3-10		5
27360	A 0	139	5 ½	3-10	x	5
26790	A 1	140	5 ½	10-25		5
27361	A 1	140	5 ½	10-25	x	5
26791	A 2	180	7	19-60		5
27362	A 2	180	7	19-60	x	5
26792	A 3	225	9	40-100		5
27363	A 3	225	9	40-100	x	5
29428	A 4	310	12	85-140		5

DIN ISO 5254.

Classic circlip pliers



for inner rings (holes) with angled shape

Z 33 1 01

Order-No.	Typ	mm	II	☉	SB	
26785	J 01	139	5 ½	8-13		5
27356	J 01	139	5 ½	8-13	x	5
26786	J 11	140	5 ½	12-25		5
27357	J 11	140	5 ½	12-25	x	5
26787	J 21	180	7	19-60		5
27358	J 21	180	7	19-60	x	5
26788	J 31	225	9	40-100		5
27359	J 31	225	9	40-100	x	5
29427	J 41	310	12	85-140		5
38938	J 41	310	12	85-140	x	5

DIN ISO 5256.

Classic circlip pliers



for outer rings (shafts), angled

Z 34 1 01

Order-No.	Typ	mm	II	☉	SB	
26794	A 01	139	5 ½	3-10		5
27364	A 01	139	5 ½	3-10	x	5
26795	A 11	140	5 ½	10-25		5
27365	A 11	140	5 ½	10-25	x	5
26796	A 21	180	7	19-60		5
27366	A 21	180	7	19-60	x	5
26797	A 31	225	9	40-100		5
27367	A 31	225	9	40-100	x	5
29429	A 41	310	12	85-140		5
38937	A 41	310	12	85-140	x	5

DIN ISO 5254.

Corner pipe pliers Classic



S-mouth

Z 26 0 00

Order-No.	mm	Ø	Icon	Icon
29435	320	1	0-40	1
29436	420	1 ½	0-55	1
29437	535	2	0-67	1

DIN 5234.

Professional revolving punch pliers



Z 65 0 05

Order-No.	mm	Icon	Ø	Icon
28402	225	9	2,0-4,5	5

Corner pipe pliers Classic



45°

Z 26 1 00

Order-No.	mm	Ø	Icon	Icon
29438	315	1	0-40	1
29439	420	1 ½	0-55	1
29440	570	2	0-67	1

DIN 5234.

Revolving punch and loop pliers Professional



Z 65 2 05

Order-No.	mm	Icon	Ø	Icon
29550	225	9	4,0-5,0	5

Corner pipe pliers Classic



90°

Z 26 2 00

Order-No.	mm	Ø	Icon	Icon
29441	320	1	0-40	1
29442	415	1 ½	0-55	1
29443	555	2	0-67	1

DIN 5234.

Gripping pliers Classic



with wire cutter

Z 66 0 00

Order-No.	mm	Icon	Ø	Icon	Icon
29485	180	7	8-30	0-20	5
29486	250	10	8-40	0-20	5
29487	300	12	8-65	0-30	5

Bolt cutter Classic



Z 27 0 01

Order-No.	mm	II	✂	Ømm	
39374	450	18	6	6	1
39376	600	24	7	8	1
39378	750	30	8	9	1
39380	900	36	9	11	1

Replacement cutter head



for bolt cutter Classic

Z 27 0 01K

Order-No.	✂	Ømm	
39375	6	6	1
39377	7	8	1
39379	8	9	1
39381	9	11	1



Pliers set Professional ESD



Diagonal cutters, oblique end cutting nippers, needle nose pliers 4-pcs.

Z 99 0 001 04

Order-No.	
33507	1
	Diagonal cutters Professional ESD wide, pointed head without bevelled edge 115mm, 4 1/2" (26821)
	Diagonal cutters Professional ESD wide, semi-rounded head with bevelled edge 115mm, 4 1/2" (26831)
	Oblique end cutting nippers Professional ESD narrow head, approx. 40° with small bevelled edge 110mm, 4 1/4" (26838)
	Needle nose pliers Professional ESD straight 120mm, 4 3/4" (26799)

SMD tweezer set Professional ESD



assorted 4-pcs.

ZP 99 0 140 02

Order-No.	
32349	1
	Universal tweezers Professional ESD Type AA 130mm, AA (32318)
	Precision tweezers Professional ESD Type PSF 130mm, PSF (32325)
	SMD tweezers Professional ESD Type 13 120mm, 13 (32340)
	SMD tweezers Professional ESD Type 59 117mm, 59 (32344)

INFOBOX:
**Electrostatic
conductive ESD
tools**

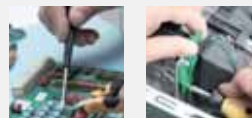

Sensitive, electronic components can be damaged even at a very low voltage.

- Dissipative tools by Wiha discharge the electrostatic energy in a controlled, safe manner.
- ESD tools meet the ESD Standard IEC 61340-5-1.
- ESD tool handles have a surface resistance of 10⁶ -10⁹ Ohm.

Diagonal cutters Professional ESD



narrow, pointed head with bevelled edge

Z 40 1 04

Order-No.	mm	II	✂	Ømm	SB	📦
26808	115	4 ½	7	0.6		5
27442	115	4 ½	7	0.6	x	5

DIN ISO 9654. IEC 61340-5-1.

Diagonal cutters Professional ESD



wide, pointed head with bevelled edge

Z 41 1 04

Order-No.	mm	II	✂	Ømm	SB	📦
26816	115	4 ½	7	1		5
27444	115	4 ½	7	1	x	5

DIN ISO 9654. IEC 61340-5-1.

Diagonal cutters Professional ESD



narrow, pointed head without bevelled edge

Z 40 3 04

Order-No.	mm	II	✂	Ømm	📦
33521	115	4 ½	2	1	5

DIN ISO 9654. IEC 61340-5-1.

Diagonal cutters Professional ESD



wide, pointed head without bevelled edge

Z 41 3 04

Order-No.	mm	II	✂	Ømm	SB	📦
26821	115	4 ½	2	1		5
27445	115	4 ½	2	1	x	5

DIN ISO 9654. IEC 61340-5-1.

Diagonal cutters Professional ESD



narrow, pointed head with small bevelled edge

Z 40 4 04

Order-No.	mm	II	✂	Ømm	SB	📦
26814	115	4 ½	2	1		5
27443	115	4 ½	2	1	x	5

DIN ISO 9654. IEC 61340-5-1.

Diagonal cutters Professional ESD



wide, pointed head and wire trapping spring with small bevelled edge

Z 41 4 04

Order-No.	mm	II	✂	Ømm	SB	📦
26822	115	4 ½	2	1.2		5
27446	115	4 ½	2	1.2	x	5

DIN ISO 9654. IEC 61340-5-1.

Diagonal cutters Professional ESD



narrow, semi-rounded head with small bevelled edge

Z 43 1 04

Order-No.	mm	II	✂	Ømm	SB	📦
26826	115	4 ½	2	1.2		5
27447	115	4 ½	2	1.2	x	5

DIN ISO 9654. IEC 61340-5-1.

Oblique end cutting nippers Professional ESD



wide head, approx. 29° with small bevelled edge

Z 46 1 04

Order-No.	mm	II	✂	Ømm	SB	📦
26835	115	4 ½	2	1.2		5
27450	115	4 ½	2	1.2	x	5

DIN ISO 9654. IEC 61340-5-1.

Diagonal cutters Professional ESD



wide, semi-rounded head with bevelled edge

Z 44 1 04

Order-No.	mm	II	✂	Ømm	SB	📦
26831	115	4 ½	7	1		5
27448	115	4 ½	7	1	x	5

DIN ISO 9654. IEC 61340-5-1.

Oblique end cutting nippers Professional ESD



narrow head, approx. 40° with small bevelled edge

Z 46 4 04

Order-No.	mm	II	✂	Ømm	SB	📦
26838	110	4 ¼	2	0.6		5
27451	110	4 ¼	2	0.6	x	5

DIN ISO 9654. IEC 61340-5-1.

Diagonal cutters Professional ESD



wide, semi-rounded head with small bevelled edge

Z 44 3 04

Order-No.	mm	II	✂	Ømm	SB	📦
26832	115	4 ½	2	1.2		5
27449	115	4 ½	2	1.2	x	5

DIN ISO 9654. IEC 61340-5-1.

End cutting nippers Professional ESD



narrow head with small bevelled edge

Z 47 1 04

Order-No.	mm	II	✂	Ømm	SB	📦
26839	110	4 ¼	2	0.6		5
27452	110	4 ¼	2	0.6	x	5

DIN ISO 9654. IEC 61340-5-1.

End cutting nippers Professional ESD



wide head with small bevelled edge

Z 47 2 04

Order-No.	mm	II	✂	Ø mm	SB	📦
26840	115	4 ½	2	1.4		5
27453	115	4 ½	2	1.4	x	5

DIN ISO 9654. IEC 61340-5-1.

Round-nose pliers Professional ESD



Short, rounded jaws

Z 37 0 04

Order-No.	mm	II	SB	📦
26804	120	4 ¾		5
27440	120	4 ¾	x	5

DIN ISO 9655. IEC 61340-5-1.

Needle nose pliers Professional ESD



straight

Z 36 0 04

Order-No.	mm	II	A	B	D	F	📦
26799	120	4 ¾	9,5	23	6,5	1,4	5
27329	120	4 ¾	9,5	23	6,5	1,4	5
27905	145	5 ¾	12,0	40	7,5	2,0	5

DIN ISO 9655. IEC 61340-5-1.

Flat-nose pliers Professional ESD



Short, flat jaws

Z 38 0 04

Order-No.	mm	II	SB	📦
26806	120	4 ¾		5
27441	120	4 ¾	x	5

DIN ISO 9655. IEC 61340-5-1.

Needle nose pliers Professional ESD



curved form, approx. 45°

Z 36 1 04

Order-No.	mm	II	SB	📦
26802	120	4 ¾		5
27439	120	4 ¾	x	5

DIN ISO 9655. IEC 61340-5-1.



Diagonal cutters Electronic



wide, pointed head without bevelled edge

Z 41 1 03

Order-No.	mm	II	✂	Ømm	SB	📦
26818	130	5 1/8	3	1.3		5
27391	130	5 1/8	3	1.3	x	5

Diagonal cutters Electronic



very narrow, pointed head without bevelled edge

Z 40 0 03

Order-No.	mm	II	✂	Ømm	SB	📦
26812	128	5	2	0.8		5
27388	128	5	2	0.8	x	5

Diagonal cutters Electronic



wide, pointed head with small bevelled edge

Z 41 3 03

Order-No.	mm	II	✂	Ømm	SB	📦
26815	135	5 1/4	8	0.8		5
27393	135	5 1/4	8	0.8	x	5

DIN ISO 9654.

Diagonal cutters Electronic



narrow, pointed head and wire trapping spring without bevelled edge

Z 40 1 03

Order-No.	mm	II	✂	Ømm	SB	📦
26813	126	5	2	1		5
27390	126	5	2	1	x	5

Diagonal cutters Electronic



wide, pointed head and wire trapping spring without bevelled edge

Z 41 6 03

Order-No.	mm	II	✂	Ømm	SB	📦
26825	130	5 1/8	3	1.3		5
27395	130	5 1/8	3	1.3	x	5

Oblique cutting nippers Electronic



wide, pointed head without bevelled edge

Z 46 0 03

Order-No.	mm	II	✂	Ømm	SB	📦
26833	128	5	3	1.3		5
27398	128	5	3	1.3	x	5

Oblique end cutting nippers Electronic



very narrow, short head without bevelled edge

Z 46 0 03

Order-No.	mm	II	✂	Ø mm	SB	
26830	125	5	2	0.6		5
27397	125	5	2	0.6	x	5

Stripping pliers Electronic



Stripping points 0.8-2.6 mm

Z 49 2 03

Order-No.	mm	II	mm ²	AWG	SB	
33471	165	6 1/2	0,81-2,59	20-10		5
36794	165	6 1/2	0,81-2,59	20-10	x	5

Needle nose pliers Electronic



narrow, short head straight form

Z 36 0 03

Order-No.	mm	II	SB	
26801	150	6		5
27326	150	6	x	5

Stripping pliers Electronic



Stripping points 0.4-1.3 mm

Z 49 7 03

Order-No.	mm	II	mm ²	AWG	SB	
33472	165	6 1/2	0,4-1,3	26-16		5
35820	165	6 1/2	0,4-1,3	26-16	x	5

Needle nose pliers Electronic



Narrow, long head, curved about 40°

Z 36 1 03

Order-No.	mm	II	SB	
41015	142	5 1/2		5
41222	142	5 1/2	x	5



Universal tweezers Professional ESD



Type AA

ZP 01 0 14

Order-No.	mm	Typ	
32318	130	AA	10

IEC 61340-5-1.

Precision tweezers Professional ESD



Type 00

ZP 11 0 14

Order-No.	mm	Typ	
32327	120	00	10

IEC 61340-5-1.

Precision tweezers Professional ESD



Type GG

ZP 06 0 14

Order-No.	mm	Typ	
32347	130	GG	10

IEC 61340-5-1.

Precision tweezers Professional ESD



Type 2a

ZP 15 0 14

Order-No.	mm	Typ	
32329	120	2a	10

IEC 61340-5-1.

Precision tweezers Professional ESD



Type PSF

ZP 07 1 14

Order-No.	mm	Typ	
32325	130	PSF	10

IEC 61340-5-1.

Precision tweezers Professional ESD



Type 3c

ZP 16 0 14

Order-No.	mm	Typ	
32346	110	3c	10

IEC 61340-5-1.

Precision tweezers Professional ESD



Type SS

ZP 09 0 14

Order-No.	mm	Typ	
32326	135	SS	10

IEC 61340-5-1.

Precision tweezers Professional ESD



Type 5

ZP 18 0 14

Order-No.	mm	Typ	
32334	110	5	10

IEC 61340-5-1.

Precision tweezers Professional ESD



Type 7a

ZP 20 1 14

Order-No.	mm	Typ	
32335	120	7a	10

IEC 61340-5-1.

SMD tweezers Professional ESD



Type 13

ZP 25 2 14

Order-No.	mm	Typ	
32340	120	13	10

IEC 61340-5-1.

Precision tweezers Professional ESD



Type 7abb

ZP 20 2 14

Order-No.	mm	Typ	
32336	120	7abb	10

IEC 61340-5-1.

Universal tweezers Professional ESD



Type 40

ZP 46 0 14

Order-No.	mm	Typ	
32343	145	40	10

IEC 61340-5-1.

SMD tweezers Professional ESD



Type 12

ZP 24 0 14

Order-No.	mm	Typ	
32338	120	12	10

IEC 61340-5-1.

SMD tweezers Professional ESD



Type 59











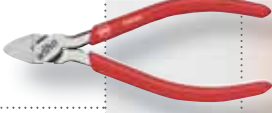

ZP 50 0 14

Order-No.	mm	Typ	
32344	117	59	10

IEC 61340-5-1.



The cutting capacities for our pliers.

Soft wire Plastic/ copper/ aluminium electrical cable/electrical cable/ silver wire									
1	2	3	4	5	6	7	8	9	10
	Diagonal cutters for plastic						Precision mechanic's needle nose pliers		
	Diagonal cutters Electronic					Precision mechanic's diagonal cutters			
	Oblique cutting nippers Electronic					Electronic diagonal cutters with bevelled edge			
	Electronic micro oblique end cutting nippers								
	Electronic micro diagonal cutters								
	ESD end cutting nippers					ESD diagonal cutters with bevelled edge			
	ESD oblique end cutting nippers								
	ESD diagonal cutters								

✂ 11

12

13

14

15

✂ 16

17

18

19

20

✂ 21

TriCut installation pliers

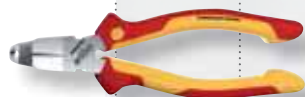

Electrician's diagonal cutters



Pincers



Inomic® combination pliers



Inomic® needle nose pliers



Lineman's pliers



BiCut® Diagonal cutters 100% / 200%

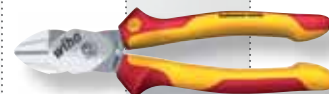

Heavy-duty Monier pliers



High-leverage combination pliers



Combination pliers



Diagonal cutters

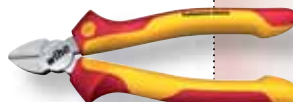

Heavy-duty diagonal cutters



End cutting nippers



Monier pliers



Needle nose pliers



Bent needle nose pliers

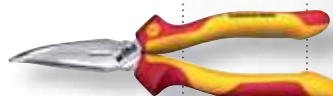



Striking and measuring tools. Optimum force transmission

With optimally uniform weight distribution, the Wiha electric hammer strikes a perfect balance and is also eminently suitable for use in confined working environments. Removing nails and nail clamps as well as fixing cables and dowels into position without causing damage become extremely simple tasks. Wiha's scaled impact screwdriver blade ensures that the portable dowel racket makes a perfectly dimensioned dowel hole to the required depth anywhere at any time without making a mess, unlike power tools.

Wiha measuring tools prove to be further dependable helpers during electrical installation work. The Wiha electrician's spirit level allows users to easily mark spaces for up to four flush boxes. This spirit level stands out due to its effortless dimension measurement and perfectly visible bubbles.

Application **Striking and measuring tools**

Impact tools

Soft-faced hammer set Safety
with assorted hammer faces, 8-pcs. in box
Page 294



Soft-faced hammer Safety
soft/medium hard with hickory wooden handle, round hammer face
Page 295



Soft-faced hammer dead-blow, medium hard
with hickory wooden handle, round hammer face
Page 296



Soft-faced hammer dead-blow, medium hard
With steel tube handle, round hammer face
Page 299



Electrician's hammer
with 300 g hammer head, in blister pack
Page 301



SoftFinish® dowel ratchet set
with dowels Phillips with 6 mm round blade in blister pack, 5-pcs.
Page 301



Measurement tools

Electrician's spirit level
40 cm
Page 302



Callipers digiMax digital
Reading 0.01 mm
Page 302



Electrician's LongLife®
folding ruler, 2 m metric, 10 segments
Page 303



Folding ruler LongLife Plus
Composite 2 m metric, 10 segments
Page 303





with assorted hammer faces, 8-pcs. in box

832 B8

Order-No.			
28050	x		1
	1 x Hickory wooden handle for safety soft-faced hammer		
	1 x Hammer face soft Round for soft-faced safety hammer		
	2 x Hammer face medium soft Round for soft-faced safety hammer		
	1 x Hammer face medium hard Round for soft-faced safety hammer		
	1 x Hammer face hard Round for soft-faced safety hammer		
	1 x Hammer face very hard Round for soft-faced safety hammer		
	1 x Hammer face soft Square for safety soft-faced hammer		
	1 x Hammer face medium hard Square for safety soft-faced hammer		
	1 x Hammer housing set with screw and locknut for Safety soft-faced hammer		
	1 x L-keys Hexagonal ball end matt chrome-plated		



INFOBOX:
Colour code system for Wiha hammer faces



Safety note:

- Always wear safety glasses and safety gloves when working with soft-faced hammers. Please observe the applicable national standards and regulations.
- Please observe the following tightening torques when replacing heads or handles:

Size 30 = 20 Nm
 Size 40 = 40 Nm
 Size 50 = 70 Nm
 Size 60 = 70 Nm
 Size 80 = 80 Nm

Hammer face

- soft (blue)
- medium soft (black)
- medium hard (yellow)
- hard (orange)
- very hard (white)

Range of uses

- for sensitive materials, such as those in furniture and interior construction, minor assembly. Material: elastomer.
- for robust work, such as paving, tiling, dry wall installation. Material: rubber.
- universal use, such as for tool and machine manufacture, car repairs, sheet metal and assembly work. Material: polyurethane.
- for high stress mechanical tasks such as assembly and dismantling work, building and construction work, repair work. Material: cellulose acetate.
- for high impact work, heavy industry and construction, mould construction, road construction, horticulture and landscaping. Material: polyamide.

Soft-faced hammer Safety soft/medium soft



with hickory wooden handle, round hammer face

832-13

Order-No.	●	g	g	g	g	g
26649	30	289	87	290	5	
26650	40	637	110	325	5	
26651	50	1117	131	360	2	
26652	60	1636	150	400	2	

Soft-faced hammer Safety medium soft/medium soft



with hickory wooden handle, round hammer face

832-33

Order-No.	●	g	g	g	g	g
26509	30	548	87	290	5	
26431	40	640	110	325	5	
26432	50	1130	131	360	2	
26433	60	1692	150	400	2	
26439	80	3136	185	490	2	

Soft-faced hammer Safety soft/medium hard



with hickory wooden handle, round hammer face

832-15

Order-No.	●	g	g	g	g	g
26653	30	272	87	290	5	
26654	40	620	110	325	5	
26655	50	1077	131	360	2	
26656	60	1555	150	400	2	

Soft-faced hammer Safety medium soft/medium hard



with hickory wooden handle, round hammer face

832-35

Order-No.	●	g	g	g	g	g
26434	30	295	87	290	5	
26435	40	636	110	325	5	
26436	50	1041	131	360	2	
26437	60	1632	150	400	2	

Soft-faced hammer Safety soft/medium hard



With hickory wooden handle, square hammer face

834-15

Order-No.	■	g	g	g	g	g
26662	40	611	110	325	5	

Hammer face soft



Round for soft-faced safety hammer

831-1

Order-No.	●	! g	📦
26663	30	20.5	5
26664	40	44	5
26665	50	83.5	2
26666	60	136	2

Hammer face medium hard



Round for soft-faced safety hammer

831-5

Order-No.	●	! g	📦
26427	30	28.2	5
26428	40	58.5	5
26429	50	117	2
26430	60	189	2

Hammer face soft



Square for safety soft-faced hammer

833-1

Order-No.	■	! g	📦
26673	40	49.5	5

Hammer face medium hard



Square for safety soft-faced hammer

833-5

Order-No.	■	! g	📦
26438	40	67	5

Hammer face medium soft



Round for soft-faced safety hammer

831-3

Order-No.	●	! g	📦
26422	30	30.6	5
26423	40	78	5
26424	50	129.5	2
26425	60	229	2
26426	80	479	2

• Also for sledgehammers

Hammer face hard



Round for soft-faced safety hammer

831-8

Order-No.	●	! g	📦
26615	30	25.5	5
26616	40	53.5	5
26618	50	53	2
26620	60	182.5	2



Hammer face very hard



Round for soft-faced safety hammer

831-9

Order-No.	●	l	g	
26510	30	26.8		5
26511	40	57.4		5
26512	50	112		2
26513	60	191		2
26514	80	395		2

• Also for sledgehammers

Hickory wooden handle



for safety soft-faced hammer

830-0

Order-No.	●	l	g	
26417	30	260	93	5
26418	40	280	119	5
26419	50	310	190	2
26420	60	340	202	2
26421	80	400	302	2
26667	80L	800	601	1

• for sledgehammer

• You will find detailed instructions on replacing at www.wiha.com

Hammer housing set



with screw and locknut for Safety soft-faced hammer

829-0

Order-No.	●	l	g	
26668	30	159		1
26669	40	375		1
26670	50	709		1
26671	60	1017		1
26672	80	1894		1

• Also for sledgehammers

• You will find detailed instructions on replacing at www.wiha.com

Hickory wooden handle



for dead-blow soft-faced hammer

800S

Order-No.	●	!	↔	↕	⊞
02113	25	295	63		10
02114	30/35	320	105		10
02115	40/45	335	142		10
02116	50	335	145		10
02117	60/70	360	192		5
28051	80•	800	792		1
28052	100•	900	1017		1

• You will find detailed instructions on replacing at www.wiha.com

Hammer face very hard



Round for soft-faced no-recoil hammer

8001K

Order-No.	●	!	↔	↕	⊞
39149	30	17.4			1
39150	40	69			1
39151	50	67			1
39152	60	115			1

Hammer face medium hard



Round for soft-faced no-recoil hammer

800K

Order-No.	●	!	↔	↕	⊞
02103	25	13.17			10
02104	30	18.4			10
02105	35	26			10
02106	40	37.5			10
02107	45	52.5			5
02108	50	72			5
02109	60	119			5
02110	70	166			5
02111	80	239			2
02102	100	394			2

INFOBOX: No-recoil soft-faced hammer

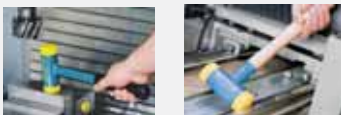

- The special metal filling in the hammer head prevents recoil.
- Approx. 25% more hammer head mass provides additional power.
- Preserves delicate surfaces and edges through high-impact effect.

SoftFinish® dowel racket set with dowels



Phillips with 6 mm round blade in blister pack, 5-pcs.

SB 534S5

Order-No.



41289

x

1

1 x PH2

2 x 30 mm Dowel / 2 x 40 mm Dowel

Electrician's hammer



with 300 g hammer head, in blister pack

846

Order-No.



42071

23,9 283 500



4

INFOBOX:
SoftFinish® dowel racket set with dowels



- Makes it easier to insert dowels and saves valuable working time.
- Ensures dirt- and dust-free work compared to machines.
- Galvanic separation between the blade and solid steel cap protects against electric shock.
- Perfect for portable use since you can make dowel holes anywhere at any time at the strike of a hammer.

INFOBOX:
Electrician's hammer



- With its optimally uniform weight distribution, this hammer ensures perfect balance, delivering impact and fatigue-free work.
- Its flat claws make it easier to remove fastening components such as nail clamps, even from difficult-to-access spots.
- Optimum access into corners and confined spaces thanks to U-shaped striking surface.
- The flat hammer handle lower surface acts as a soft-faced hammer, ensuring components such as cables and dowels are fixed into position without causing damage.

Electrician's spirit level



40 cm

246

Order-No.	mm	g	
42074	400	330	10

Callipers digiMax digital



Reading 0.01 mm

411 170 1

Order-No.	mm	g	g	
29422	150	6	139	1

CE compliant.

Callipers caliMax®



Reading 0.1 mm

411 320 3

Order-No.	mm	g	g	
27083	150	6	74	1

Analogue callipers dialMax



Reading 0.1 mm

411 210 2

Order-No.	mm	g	g	
27082	150	6	104	1

Analogue callipers dialMax ESD



Reading 0.1 mm

411 210 8

Order-No.	mm	g	g	
31439	150	6	96	1

IEC 61340-5-1.

INFOBOX: Electrician's spirit level, 40 cm



- Quick, easy marking of positions for up to four flush boxes in just one simple work step thanks to the integrated marking points.
- The continuous housing allows users to mark lines without interruption.
- An additional scale on the upper surface ensure precise measurement even when viewing from above.
- The bubbles are clearly visible, even from a sharp angle.
- The level is perfectly suitable for portable use thanks to its compact design.

Electrician's Longlife® folding ruler, 2 m



metric, 10 segments

4102008

Order-No.	Length	Color	Segments	Units
42068	15	orange	135	10

Folding ruler LongLife Plus 2 m



metric, 10 segments

410 2001

Order-No.	Length	Color	Segments	Units
27055	15	yellow	136	10
27059	15	white	136	10

Folding ruler LongLife Plus Composite 2 m



metric, 10 segments

410 2005

Order-No.	Length	Color	Segments	Units
37067	15	red/ black	124	10

Folding ruler Longlife 2 m



metric, 10 segments

410 2000

Order-No.	Length	Color	Segments	Units
27058	15	yellow	137	10
27057	15	white	136	10

Folding ruler Longlife All in One 2 m



metric, 10 segments

410 2007

Order-No.	Length	Color	Segments	Units
33232	15	white	139	10

Folding ruler Longlife 1 m



metric, 10 segments

410 1000

Order-No.	Length	Color	Segments	Units
27061	13	yellow	43	10
27062	13	white	43.5	10

INFOBOX:
Longlife® Plus
composite folding
ruler











- High rigidity minimises risk of breakage.
- Tight 90° and 180° latching of all joints.
- Metal ends which cannot be lost on the first and last segment.
- Scale running backwards (recto and verso) enables reading from both sides.

Which drives are used for each individual product?

Screwdrivers, torque tools









Screwdrivers



								
	Slotted	Phillips PH	Xeno SL/PH	Pozidriv PZ	Xeno SL/PZ	TORX®	TORX® Tamper Resistant	TORX PLUS®
Screwdriver SoftFinish®	•	•		•		•	•	•
SoftFinish® screwdriver with fixing function	•	•						
SoftFinish® screwdriver with mm scale	•	•		•				
SoftFinish® Stubby screwdriver	•	•		•				
Screwdriver MicroFinish®	•	•		•		•		
Pocket screwdrivers	•							
PicoFinish® fine screwdriver	•	•		•		•		•
Screwdriver SoftFinish® electric slimFix	•	•	•	•	•	•	•	
Screwdriver SoftFinish® electric	•	•	•	•	•	•		
Bit slimBit electric	•	•	•	•	•	•		
PicoFinish® electric fine screwdriver	•	•						
Voltage tester	•							
Screwdriver SoftFinish® ESD	•	•		•		•		
SoftFinish® ESD Stubby screwdriver	•	•		•				
Screwdriver Precision ESD	•	•		•		•		•

Torque tools



								
	Slotted	Phillips PH	Xeno SL/PH	Pozidriv PZ	Xeno SL/PZ	TORX®	TORX® Tamper Resistant	TORX PLUS®
Variably adjustable torque screwdriver	•	•		•		•		•
Torque screwdriver firmly pre-set	•	•		•		•		•
Electric torque screwdriver	•	•	•	•	•	•		
Bit slimBit electric	•	•	•	•	•	•		
Torque screwdriver with T-handle						•		•
TorqueFix® torque screwdriver with key handle						•		•

												
internal hexagon	Hex	Square	Square nut	Internal hexagon with drill hole (tamper-resistant)	Triangular nut	Multitooth Tri-Wing®	Torq-Set®	SIT	Spanner	Pentalobe PL	Y-Type	

•	•				•							
	•											
•	•										•	•
•	•	•										
•	•	•										
•	•	•										
•	•											
•	•											

												
internal hexagon	Hex	Square	Square nut	Internal hexagon with drill hole (tamper-resistant)	Triangular nut	Multitooth Tri-Wing®	Torq-Set®	SIT	Spanner	Pentalobe PL	Y-Type	

•	•											
•	•											
•		•										
•		•										
•												
•												
•												



Which drives are used for each individual product?

Multi-tools, L-keys, bits

Multitools



							
Slotted	Phillips PH	Xeno SL/PH	Pozidriv PZ	Xeno SL/PZ	TORX®	TORX® Tamper Resistant	TORX PLUS®

Screwdriver with bit magazine LiftUp electric	•	•		•	•	•	
Screwdriver with bit magazine LiftUp 26one®	•	•		•		•	
Screwdriver with LiftUp 25 magnetic bit magazine	•	•		•		•	
Screwdriver with bit magazine	•	•		•		•	
Stubby screwdriver with telescopic bit magazine	•	•		•		•	
Multitool PocketStar L-key	•	•				•	•
Screwdriver with interchangeable blade SYSTEM 6	•	•		•		•	•
Screwdriver with interchangeable blade SYSTEM 4	•	•		•		•	

L-keys

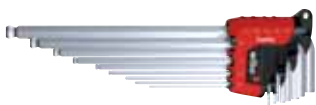

							
Slotted	Phillips PH	Xeno SL/PH	Pozidriv PZ	Xeno SL/PZ	TORX®	TORX® Tamper Resistant	TORX PLUS®













L-keys					•	•	•
L-key set in ErgoStar holder					•		
L-key set in ProStar holder					•		
L-key set in Compact holder							
L-key set in Classic holder					•	•	•
L-key with T-handle ComfortGrip					•		
L-key with Classic T-handle					•		•
L-key with T-handle electric							
L-key with key handle					•		•
L-key with flag handle					•		•

Bits















							
Slotted	Phillips PH	Xeno SL/PH	Pozidriv PZ	Xeno SL/PZ	TORX®	TORX® Tamper Resistant	TORX PLUS®













TY-Bit		•		•	•		
T-Bit		•		•	•		
Y-Bit		•		•	•		
Bit Standard	•	•		•	•	•	•
Bit Professional	•	•	•	•	•	•	•
Bits with MagicRing®							
Bit with thread		•		•	•		
Standard bit in C4 size	•	•			•		

												
internal hexagon	Hex	Square	Square nut	Internal hexagon with drill hole (tamper-resistant)	Triangular nut	Multitooth	Tri-Wing®	Torq-Set®	SIT	Spanner	Pentalobe PL	Y-Type

•		•										
•												
•												
•	•						•	•				
•	•											
•	•											

												
internal hexagon	Hex	Square	Square nut	Internal hexagon with drill hole (tamper-resistant)	Triangular nut	Multitooth	Tri-Wing®	Torq-Set®	SIT	Spanner	Pentalobe PL	Y-Type

•												
•												
•												
•												
•												
•												
•												
•	•		•									
•	•											
•												

												
internal hexagon	Hex	Square	Square nut	Internal hexagon with drill hole (tamper-resistant)	Triangular nut	Multitooth	Tri-Wing®	Torq-Set®	SIT	Spanner	Pentalobe PL	Y-Type

•		•										
•												
•		•		•		•	•	•	•	•		
•		•						•				
•												
•	•										•	







Wiha order number register

Order-No.		Order-No.		Order-No.		Order-No.	
00		00732	151	00882	139	01023	148
00456	141	00733	151	00894	218	01024	148
00576	193	00734	151	00895	218	01025	148
00577	193	00735	151	00896	218	01026	148
00578	193	00736	151	00897	218	01027	148
00579	193	00737	151	00904	214	01028	148
00580	193	00738	151	00905	214	01029	148
00582	193	00739	151	00906	214	01030	148
00583	193	00740	151	00907	214	01031	148
00584	193	00754	146	00908	214	01032	148
00585	193	00756	146	00909	214	01033	148
00586	193	00757	146	00910	214	01034	143
00587	193	00759	146	00911	214	01076	148
00597	193	00760	146	00912	214	01077	148
00598	193	00762	146	00913	214	01078	148
00599	193	00763	146	00914	214	01079	148
00600	193	00764	151	00915	214	01081	148
00601	193	00765	151	00916	214	01092	149
00602	193	00766	151	00917	214	01093	149
00603	193	00767	151	00918	214	01094	149
00610	191	00768	146	00919	214	01095	149
00613	191	00770	146	00921	214	01096	149
00616	191	00772	146	00922	214	01097	149
00623	187	00774	146	00923	214	01098	149
00629	190	00776	151	00924	214	01121	210
00630	190	00777	151	00926	214	01122	210
00631	190	00778	151	00928	214	01123	210
00632	190	00779	151	00929	214	01124	210
00635	190	00819	139	00930	214	01126	210
00636	190	00820	139	00931	214	01128	210
00637	190	00821	139	00933	214	01130	210
00638	190	00822	139	00934	214	01131	210
00639	190	00823	139	00937	214	01132	210
00654	190	00824	139	00953	205	01133	210
00655	190	00825	139	00965	215	01134	210
00656	190	00826	139	00966	215	01135	210
00657	190	00827	139	00967	215	01136	210
00658	190	00828	139	00968	215	01137	210
00665	190	00829	139	00969	215	01138	210
00666	190	00830	139	00970	215	01139	210
00667	190	00831	139	00971	215	01140	210
00679	151	00832	139	00972	215	01141	210
00683	151	00833	135	00973	215	01142	210
00684	146	00834	135	00974	215	01143	210
00685	146	00846	139	00975	215	01285	147
00686	146	00847	139	00977	215	01286	147
00687	146	00848	139	00978	215	01287	147
00689	146	00849	139	00979	215	01288	147
00690	146	00850	139	00980	215	01289	147
00691	146	00853	140	00982	215	01290	147
00692	146	00855	140	00983	215	01291	147
00694	146	00856	140	00985	215	01292	147
00695	146	00857	140	00986	215	01293	147
00696	146	00858	140	00988	215	01294	147
00697	146	00859	140	00989	215	01295	147
00698	146	00860	140	00990	215	01296	147
00700	146	00861	140	00991	215	01297	147
00701	146	00862	140	00993	215	01299	142
00702	146	00863	140	00994	215	01300	147
00703	146	00864	140	00995	215	01301	147
00704	146	00865	140	01		01302	147
00706	146	00866	140	01005	215	01303	147
00707	146	00867	140	01006	215	01304	147
00708	146	00868	140	01007	215	01305	147
00709	146	00877	139	01008	215	01306	147
00711	146	00878	139	01018	148	01310	211
00712	146	00879	139	01020	148	01311	211
00713	146	00880	139	01021	148	01312	211
00731	151	00881	139	01022	148	01313	211

Order-No.		Order-No.		Order-No.		Order-No.	
01314	211	01443	149	01803	236	02805	216
01315	211	01475	248	01805	236	02806	216
01316	211	01476	248	01808	237	02807	216
01317	211	01479	248	01809	237	02808	216
01318	211	01481	249	01811	237	02809	216
01319	211	01508	154	01812	237	02810	216
01320	211	01537	154	01894	247	02811	216
01321	211	01538	154	01895	247	02819	216
01322	211	01539	154	01910	247	02820	216
01323	211	01548	154	01912	247	02821	216
01324	211	01623	231	01913	247	02822	216
01326	205	01624	231	01919	248	02823	216
01328	217	01626	231	01922	245	02824	216
01329	217	01627	231	01923	245	02836	148
01330	217	01649	231	01924	245	02837	148
01331	217	01657	231	01926	245	02838	148
01332	217	01658	231	01927	245	02839	148
01333	217	01659	231	01930	245	02840	148
01334	217	01681	231	01933	244	02841	148
01335	217	01688	231	01935	245	02939	199
01336	217	01689	231	01937	243	03	
01337	217	01690	231	01938	243	03106	147
01338	217	01703	232	01939	243	03107	147
01339	217	01704	232	01940	243	03108	147
01340	217	01705	232	01942	243	03115	231
01341	217	01706	232	01943	243	03117	231
01343	217	01707	232	01945	243	03186	193
01345	217	01708	232	01946	243	03223	150
01348	205	01709	232	01947	243	03224	150
01350	218	01710	232	01948	243	03225	150
01351	218	01711	231	02		03226	150
01352	218	01712	231	02091	299	03228	150
01353	218	01713	231	02092	299	03230	150
01354	218	01714	231	02093	299	03231	150
01355	218	01715	231	02094	299	03232	150
01356	218	01716	231	02095	299	03237	150
01391	209	01717	231	02096	299	03238	150
01392	208	01718	231	02097	299	03239	150
01393	208	01719	231	02098	299	03245	150
01395	208	01720	231	02099	299	03246	150
01396	208	01721	231	02101	299	03247	150
01398	208	01722	231	02102	300	03591	187
01400	208	01723	231	02103	300	03723	199
01402	208	01724	231	02104	300	03724	218
01404	208	01726	231	02105	300	03725	218
01406	208	01727	231	02106	300	03726	218
01408	208	01728	231	02107	300	03727	218
01416	199	01729	231	02108	300	03728	218
01418	199	01730	231	02109	300	03729	218
01420	199	01731	231	02110	300	03730	218
01422	209	01732	231	02111	300	03731	218
01423	209	01733	231	02113	300	03738	146
01424	209	01734	232	02114	300	03739	146
01425	209	01735	232	02115	300	03760	139
01426	209	01736	232	02116	300	03761	139
01427	209	01737	232	02117	300	03762	139
01428	209	01738	232	02122	299	03764	211
01429	209	01739	232	02123	299	03847	157
01430	209	01740	232	02124	299	03848	157
01431	209	01790	236	02125	299	03849	157
01432	209	01791	236	02126	299	03850	157
01433	209	01792	236	02127	299	03851	157
01434	209	01793	236	02128	299	03852	157
01435	149	01794	236	02129	299	03853	157
01436	149	01795	236	02292	199	03854	157
01437	149	01796	236	02568	154	03868	209
01438	149	01798	236	02802	216	03869	209
01439	149	01799	236	02803	216	03870	209
01440	149	01800	236	02804	216	03871	209

Wiha order number register

Order-No.		Order-No.		Order-No.		Order-No.	
03872	209	05300	231	07660	159	20222	238
03873	209	05301	239	07661	159	20223	238
03874	209	05302	239	07662	159	20224	238
03875	209	05303	239	07663	159	20542	234
03876	209	05638	209	07664	159	20549	207
03878	199	05799	237	07665	159	20550	207
03879	199	05800	236	07666	159	20551	207
03882	190	06		07667	158	20552	207
03883	190	06059	209	07855	234	20553	207
03988	156	06218	210	07856	234	20554	186
03991	199	06358	209	07857	234	20555	232
03992	199	06359	209	07858	234	20556	232
04		06360	209	07859	234	20557	232
04009	236	06361	209	07860	234	20558	232
04010	236	06362	209	07861	234	20559	232
04011	232	06363	209	07862	234	20560	232
04059	237	06364	209	07865	234	20570	207
04096	214	06365	209	07866	234	20783	186
04099	214	06366	209	07869	247	21	
04105	214	06367	209	07874	240	21045	238
04108	214	06368	209	07875	240	21047	238
04111	214	06369	209	07922	208	21248	143
04126	236	06370	209	07943	229	21249	143
04127	236	06371	209	08		21250	144
04176	237	06378	200	08047	235	21251	144
04194	239	06379	200	08048	235	21255	159
04195	239	06382	200	08049	235	21256	159
04196	239	06384	200	08056	235	21960	214
04197	239	06386	200	08057	235	21962	214
04198	239	06634	232	08058	235	22	
04204	244	06635	232	08065	235	22096	205
04362	245	06636	232	08066	235	22168	214
04508	244	06637	239	08067	235	22170	214
04509	244	06638	239	08068	235	22172	214
04510	244	06639	239	08069	235	22174	214
04511	244	06888	236	08070	235	22436	158
04512	244	06889	237	08179	158	22509	236
04513	244	07		08182	158	22510	236
04514	244	07152	142	08183	158	22511	236
04515	244	07153	142	08184	158	22512	237
04516	244	07155	142	08185	158	22591	232
04517	244	07185	198	08186	158	22592	232
04631	244	07192	198	08419	240	22593	232
04632	244	07634	159	08420	240	22594	232
04633	244	07635	159	08421	234	22595	232
04634	244	07636	159	08422	234	22596	239
04635	244	07637	159	08423	234	22597	239
04636	244	07638	159	08424	234	22598	239
04637	244	07639	159	08425	234	22599	239
04638	244	07640	159	08426	234	22600	239
04639	244	07641	159	08463	157	22603	233
04640	244	07642	159	08900	190	22604	233
04670	243	07643	159	08901	190	22605	233
04671	243	07644	159	08902	190	22606	233
04677	243	07645	159	08903	190	22607	233
04678	243	07646	159	08904	190	22608	233
04684	245	07647	159	08905	190	22651	234
04685	245	07648	159	08906	190	22653	234
04918	218	07649	159	08907	190	22655	234
04925	231	07650	159	08908	190	22955	232
04926	231	07651	159	08909	190	22956	232
04927	231	07652	159	08911	190	22957	232
04928	231	07653	159	09		22958	232
04929	231	07654	159	09393	230	22959	232
04930	231	07655	159	20		22960	232
04931	231	07656	159	20218	238	22961	232
05		07657	159	20219	238	22962	232
05271	141	07658	159	20220	238	23	
05298	231	07659	159	20221	238	23031	185

Order-No.		Order-No.		Order-No.		Order-No.	
23033	185	24319	211	26060	171	26176	213
23035	185	24320	211	26061	171	26177	213
23037	185	24321	211	26062	171	26178	213
23040	185	24322	211	26063	171	26179	249
23041	185	24323	211	26064	170	26181	218
23047	183	24324	211	26065	170	26182	218
23049	183	24325	211	26066	170	26183	218
23051	184	24341	207	26067	170	26184	218
23053	184	24506	142	26068	170	26185	218
23145	238	24513	212	26069	170	26186	218
23147	238	24515	212	26070	170	26187	218
23149	238	24517	212	26071	170	26188	218
23151	238	24519	212	26072	170	26190	147
23159	154	24521	212	26073	170	26191	147
23173	231	24523	212	26077	147	26192	147
23175	231	24525	212	26079	147	26193	147
23177	231	24527	212	26081	147	26194	147
23179	231	24529	212	26083	147	26195	147
23181	231	24531	212	26085	147	26196	170
23183	231	24533	212	26087	147	26197	170
23185	231	24733	234	26091	147	26198	170
23187	231	24742	234	26093	147	26199	170
23189	231	24746	234	26095	147	26200	171
23191	231	24748	234	26097	147	26212	149
23193	231	24851	198	26099	147	26213	149
23195	238	24852	203	26101	147	26214	149
23197	238	24867	238	26103	147	26216	149
23199	238	25		26105	147	26217	149
23201	238	25097	231	26107	147	26218	149
23203	238	25128	184	26109	147	26221	171
23205	238	25130	184	26111	147	26222	171
23207	238	25164	184	26113	142	26223	171
23209	238	25166	184	26121	191	26224	171
23211	238	25293	183	26122	193	26225	171
23213	236	25295	183	26123	193	26227	170
23215	236	25477	135	26124	193	26228	170
23217	236	25553	238	26127	169	26229	171
23219	236	25560	232	26128	169	26230	148
23221	237	25561	232	26129	169	26231	148
23223	237	25562	232	26130	169	26232	148
23225	237	25563	232	26131	169	26233	148
23226	237	25564	232	26133	169	26234	148
23227	237	25572	232	26135	213	26235	148
23228	237	25624	206	26136	213	26247	204
24		25625	206	26137	213	26248	204
24107	212	25676	159	26138	213	26249	232
24109	212	25677	159	26139	213	26250	231
24111	212	25679	234	26140	213	26252	230
24113	212	25681	234	26148	170	26253	230
24115	212	25739	238	26151	170	26259	147
24117	212	25740	238	26152	170	26260	147
24119	212	25741	238	26154	170	26261	206
24121	212	25742	238	26155	170	26277	170
24123	212	25874	248	26156	170	26278	170
24189	198	25994	231	26157	170	26279	170
24302	207	25996	231	26158	170	26303	147
24303	207	25998	231	26159	170	26304	147
24304	207	26		26164	213	26305	147
24305	207	26000	238	26165	213	26307	147
24306	207	26002	238	26166	213	26309	232
24307	207	26045	232	26167	213	26327	169
24308	207	26047	169	26168	213	26328	147
24312	203	26048	169	26169	213	26329	147
24313	211	26049	169	26170	213	26330	147
24314	211	26051	169	26171	213	26331	147
24315	211	26052	169	26172	213	26332	147
24316	211	26053	169	26173	213	26333	147
24317	211	26058	170	26174	213	26346	232
24318	211	26059	170	26175	213	26347	232

Wiha order number register

Order-No.		Order-No.		Order-No.		Order-No.	
26348	232	26647	296	26744	254	26852	252
26349	232	26648	296	26745	254	26853	266
26350	232	26649	295	26755	115	26854	267
26351	232	26650	295	26757	276	26864	171
26352	232	26651	295	26758	276	26865	175
26353	232	26652	295	26759	276	26866	175
26354	232	26653	295	26760	275	26888	168
26355	232	26654	295	26761	275	26889	170
26356	232	26655	295	26762	275	26893	168
26417	298	26656	295	26763	275	26901	169
26418	298	26657	296	26764	276	26919	157
26419	298	26658	296	26765	276	26920	154
26420	298	26659	296	26766	276	26925	169
26421	298	26660	296	26767	276	26928	158
26422	297	26661	296	26771	277	26929	158
26423	297	26662	295	26772	277	26931	146
26424	297	26663	297	26773	277	26953	217
26425	297	26664	297	26774	277	26954	217
26426	297	26665	297	26775	277	26955	217
26427	297	26666	297	26776	277	26956	217
26428	297	26667	298	26777	277	26957	217
26429	297	26668	298	26778	277	26958	217
26430	297	26669	298	26779	277	26959	217
26431	295	26670	298	26780	277	26960	217
26432	295	26671	298	26781	279	26964	151
26433	295	26672	298	26782	279	26965	151
26434	295	26673	297	26783	279	26966	151
26435	295	26674	296	26784	279	26967	151
26436	295	26703	270	26785	279	26968	151
26437	295	26704	270	26786	279	26969	151
26438	297	26705	256	26787	279	26970	151
26439	295	26706	270	26788	279	26971	151
26451	234	26707	270	26789	279	26972	151
26454	146	26708	256	26790	279	26973	151
26455	146	26709	270	26791	279	27	
26456	147	26710	270	26792	279	27028	232
26457	147	26711	256	26793	267	27030	232
26458	147	26712	271	26794	279	27055	303
26461	168	26713	271	26795	279	27057	303
26462	168	26714	256	26796	279	27058	303
26463	168	26715	271	26797	279	27059	303
26464	168	26716	271	26799	285	27061	303
26509	295	26717	256	26801	287	27062	303
26510	298	26718	272	26802	285	27064	232
26511	298	26719	271	26804	285	27065	232
26512	298	26720	258	26806	285	27066	232
26513	298	26721	272	26808	283	27067	232
26514	298	26722	271	26812	286	27077	235
26544	171	26723	273	26813	286	27079	170
26582	296	26724	272	26814	283	27082	302
26611	296	26725	273	26815	286	27083	302
26612	296	26726	272	26816	283	27144	158
26613	296	26727	258	26818	286	27145	158
26614	296	26728	258	26821	283	27146	158
26615	297	26729	258	26822	283	27147	158
26616	297	26730	274	26825	286	27148	158
26618	297	26731	274	26826	284	27149	158
26620	297	26732	259	26830	287	27150	158
26625	163	26733	274	26831	284	27151	158
26626	163	26734	274	26832	284	27252	157
26627	163	26735	259	26833	286	27253	157
26629	175	26736	268	26835	284	27256	232
26640	296	26737	254	26838	284	27257	232
26641	296	26738	269	26839	284	27258	232
26642	296	26739	269	26840	285	27259	232
26643	296	26740	268	26845	261	27260	232
26644	296	26741	254	26846	261	27325	270
26645	296	26742	269	26847	260	27326	287
26646	296	26743	268	26850	266	27327	270

Order-No.	
27328	256
27329	285
27336	270
27337	270
27338	271
27339	271
27340	272
27341	272
27342	273
27343	273
27344	274
27345	274
27346	269
27347	269
27348	269
27350	275
27351	276
27352	279
27353	279
27354	279
27355	279
27356	279
27357	279
27358	279
27359	279
27360	279
27361	279
27362	279
27363	279
27364	279
27365	279
27366	279
27367	279
27368	261
27372	276
27373	276
27374	276
27375	277
27376	277
27377	277
27378	277
27379	277
27380	277
27381	275
27382	275
27383	276
27384	276
27388	286
27390	286
27391	286
27393	286
27395	286
27397	287
27398	286
27399	270
27400	270
27401	271
27402	271
27403	271
27404	271
27405	272
27406	272
27407	274
27408	274
27409	268
27410	268
27414	275
27415	276
27417	261

Order-No.	
27418	256
27419	256
27420	256
27421	256
27422	258
27423	258
27424	258
27425	258
27426	259
27427	259
27428	254
27429	254
27430	254
27431	254
27437	260
27439	285
27440	285
27441	285
27442	283
27443	283
27444	283
27445	283
27446	283
27447	284
27448	284
27449	284
27450	284
27451	284
27452	284
27453	285
27501	277
27502	277
27503	277
27504	277
27507	268
27526	171
27530	232
27606	154
27614	218
27615	218
27616	218
27617	218
27618	218
27619	218
27620	218
27621	218
27627	190
27628	190
27629	190
27630	190
27631	190
27632	190
27633	190
27634	190
27635	190
27636	190
27637	190
27638	190
27639	190
27641	158
27687	175
27707	159
27708	159
27712	188
27713	188
27715	188
27736	146
27737	146
27738	146

Order-No.	
27739	146
27740	146
27741	146
27742	146
27743	146
27744	146
27745	146
27746	142
27748	159
27749	159
27750	159
27751	159
27752	159
27753	146
27754	146
27755	146
27756	146
27757	146
27758	146
27759	159
27761	159
27762	159
27763	159
27764	159
27765	159
27766	159
27767	159
27811	146
27812	170
27813	170
27814	170
27815	170
27816	170
27817	170
27818	170
27820	191
27873	243
27876	243
27877	243
27879	243
27880	243
27882	243
27883	243
27884	243
27885	243
27886	243
27887	243
27888	243
27889	243
27890	243
27891	243
27892	244
27893	244
27894	244
27895	244
27896	244
27897	244
27898	244
27899	244
27900	244
27901	244
27902	154
27905	285
27928	216
27929	216
27930	216
27931	216
27932	216
27933	216

Order-No.	
27934	216
27935	216
27936	183
27963	244
27964	217
27965	217
27966	217
27967	217
27968	217
27969	217
27970	217
27971	217
28	
28005	147
28026	243
28027	244
28050	294
28051	300
28052	300
28053	159
28055	243
28056	243
28057	243
28058	244
28198	159
28330	264
28372	213
28373	213
28374	213
28375	213
28376	213
28377	213
28402	280
28481	238
28691	165
28691	173
28734	173
28735	173
28736	173
28737	173
28738	173
28739	173
28740	173
28741	173
28742	173
28743	173
28744	173
28745	173
28746	173
28747	173
28748	173
28749	173
28756	173
28757	173
28758	173
28760	147
28761	147
28762	147
28763	147
28764	147
28765	147
28766	147
28767	147
28769	147
28770	147
29	
29115	155
29116	155
29117	155

Wiha order number register

Order-No.		Order-No.		Order-No.		Order-No.	
29118	155	29420	266	31240	210	32319	271
29119	155	29422	302	31241	210	32320	271
29120	155	29425	279	31242	210	32322	272
29121	155	29427	279	31243	210	32323	272
29122	155	29428	279	31244	210	32324	272
29123	155	29429	279	31432	158	32325	288
29124	155	29435	280	31439	302	32326	288
29125	155	29436	280	31496	189	32327	288
29133	156	29437	280	31497	189	32328	272
29134	156	29438	280	31498	193	32329	288
29135	156	29439	280	31499	193	32330	274
29136	156	29440	280	31771	141	32332	274
29137	156	29441	280	31863	139	32334	288
29138	155	29442	280	31901	158	32335	289
29139	155	29443	280	31957	237	32336	289
29140	155	29463	248	31958	237	32338	289
29141	155	29466	135	31959	237	32340	289
29142	155	29467	170	31960	236	32342	275
29143	155	29471	208	31961	236	32343	289
29144	155	29472	208	31962	236	32344	289
29145	155	29473	208	31973	238	32345	261
29149	156	29474	208	31975	238	32346	288
29150	156	29475	208	31977	238	32347	288
29151	156	29485	280	32		32349	282
29152	156	29486	280	32055	234	32352	276
29153	156	29487	280	32070	234	32383	146
29154	156	29544	235	32071	234	32384	146
29158	156	29550	280	32105	236	32386	210
29159	156	29553	170	32151	158	32387	210
29160	156	29554	170	32152	158	32388	210
29161	156	29555	170	32153	158	32389	210
29162	156	29556	170	32154	158	32390	210
29163	156	29557	170	32155	158	32391	210
29164	156	29558	170	32156	158	32392	210
29165	156	29559	170	32157	158	32393	210
29166	156	29560	170	32160	248	32394	202
29167	156	30		32161	249	32395	202
29168	156	30050	232	32201	141	32396	139
29169	155	30066	264	32249	142	32397	139
29170	156	30361	139	32250	146	32399	146
29171	156	30362	139	32251	146	32400	146
29172	156	30363	139	32252	146	32404	150
29173	156	30364	139	32253	146	32405	150
29174	156	30365	139	32254	146	32406	150
29175	156	30366	139	32255	146	32409	237
29176	156	30372	189	32256	146	32410	237
29177	156	30373	193	32264	147	32411	237
29197	212	30404	189	32265	147	32412	237
29198	212	30495	175	32278	157	32413	237
29199	212	30700	139	32279	157	32414	237
29200	212	30701	139	32281	135	32415	237
29201	212	30715	139	32282	135	32416	237
29202	212	30716	139	32298	188	32417	237
29203	212	30824	123	32299	237	32418	237
29204	212	30826	270	32302	237	32419	237
29205	212	30827	268	32303	237	32421	237
29206	212	30852	170	32304	237	32423	237
29207	212	30975	268	32305	237	32477	246
29208	204	30976	268	32306	237	32484	249
29228	172	30978	270	32307	237	32486	238
29229	172	30979	270	32308	237	32490	237
29230	172	31		32309	238	32491	237
29231	172	31233	210	32310	249	32492	237
29232	172	31234	210	32311	249	32493	237
29233	172	31235	210	32312	159	32494	237
29234	172	31236	210	32313	159	32495	237
29236	172	31237	210	32314	159	32496	237
29416	227	31238	210	32315	159	32497	237
29417	227	31239	210	32318	288	32505	242

Order-No.	
32547	245
32556	245
32573	245
32686	237
32687	237
32688	237
32689	237
32804	240
32805	240
32806	240
32807	240
32808	240
32809	240
32867	150
32868	150
32869	150
32870	150
32871	150
32901	182
32902	182
32903	182
33	
33007	182
33008	182
33009	182
33177	254
33178	258
33186	256
33232	303
33259	257
33261	257
33471	287
33472	287
33503	192
33504	123
33505	123
33507	282
33520	260
33521	283
33699	239
33700	239
33701	239
33702	239
33703	236
33704	236
33705	236
33706	237
33707	237
33708	237
33709	237
33710	237
33711	237
33712	237
33713	237
33714	237
33715	237
33716	238
33717	237
33718	237
33719	237
33720	237
33721	237
33722	237
33723	238
33724	238
33725	237
33726	237
33727	237
33728	237

Order-No.	
33729	238
33730	238
33731	238
33732	238
33736	182
33738	182
33740	182
33741	182
33743	182
33744	182
33746	182
33749	210
33750	210
33753	201
33754	201
33764	182
33765	247
33841	265
33842	265
33843	265
33844	265
33848	192
33920	238
33921	238
33922	238
33923	238
33924	238
33925	238
33926	238
33927	238
33928	238
33929	238
33930	238
33931	238
33932	238
33961	236
33962	236
33963	236
33964	236
33965	236
33966	236
33969	114
33970	122
33971	122
34	
34306	247
34307	270
34308	270
34309	272
34310	274
34311	268
34312	275
34313	261
34452	237
34453	237
34454	237
34455	237
34456	237
34457	237
34515	272
34516	268
34518	276
34533	169
34554	239
34555	239
34556	239
34557	239
34558	239
34559	239

Order-No.	
34560	239
34565	270
34566	271
34567	271
34568	274
34569	272
34570	272
34571	268
34577	137
34578	137
34578	167
34579	137
34579	167
34580	137
34580	167
34581	137
34581	167
34582	137
34582	167
34583	137
34583	167
34584	137
34584	167
34585	137
34585	167
34586	137
34586	167
34587	137
34587	167
34588	137
34588	167
34589	137
34589	167
34590	137
34590	167
34614	168
34686	229
34688	278
34689	278
34690	278
34691	278
34692	278
34693	278
34694	278
34695	278
34696	278
34697	278
34698	278
34699	278
34700	278
34701	278
34702	278
34703	278
34704	278
34705	278
34706	278
34707	278
34708	267
34729	260
34730	260
34736	203
34737	203
34738	203
34740	201
34741	201
34742	204
34743	259
34744	259
34745	141

Order-No.	
34746	234
35	
35378	141
35389	134
35390	138
35391	138
35392	138
35393	138
35394	138
35395	138
35396	138
35397	150
35398	150
35399	150
35400	243
35401	243
35402	243
35403	243
35446	138
35456	236
35457	236
35462	258
35465	256
35477	258
35479	259
35480	198
35481	198
35482	208
35483	208
35484	208
35485	208
35486	208
35487	208
35488	208
35489	208
35490	208
35501	138
35502	138
35503	138
35504	138
35505	138
35506	137
35506	167
35507	137
35507	167
35508	137
35508	167
35509	137
35509	167
35510	137
35510	167
35511	137
35511	167
35538	263
35704	259
35705	259
35709	234
35820	287
35832	234
35834	234
35861	264
35862	264
35870	166
35969	263
36	
36038	275
36039	275
36040	276
36041	276

Wiha order number register

Order-No.		Order-No.		Order-No.		Order-No.	
36050	262	36457	203	37871	141	38713	240
36051	263	36458	204	37872	141	38714	240
36052	263	36459	204	38		38715	240
36053	263	36460	203	38020	114	38716	240
36071	137	36461	203	38060	268	38717	240
36071	167	36462	204	38074	163	38718	240
36072	150	36483	273	38189	268	38798	263
36073	150	36486	202	38190	268	38800	174
36079	166	36487	202	38191	254	38801	174
36082	240	36503	201	38362	134	38802	174
36085	150	36504	201	38370	237	38803	174
36086	240	36521	197	38371	237	38804	174
36092	247	36522	197	38372	237	38805	174
36093	247	36536	138	38552	253	38806	174
36094	247	36537	138	38556	174	38807	174
36112	248	36538	138	38557	174	38808	174
36114	186	36539	138	38558	174	38809	174
36189	273	36540	138	38600	182	38810	174
36193	240	36541	138	38601	182	38811	174
36205	144	36542	138	38605	182	38812	174
36217	260	36558	134	38606	182	38813	174
36218	278	36711	260	38610	180	38814	174
36219	278	36791	162	38611	180	38815	174
36220	278	36794	287	38612	180	38816	174
36221	278	36800	246	38613	180	38817	174
36222	278	36846	169	38616	174	38818	174
36223	278	36847	169	38617	174	38819	174
36224	278	36849	168	38618	174	38820	174
36225	278	36850	168	38619	174	38853	253
36226	278	36851	175	38620	174	38854	253
36229	169	36852	175	38621	174	38855	256
36230	169	36886	168	38622	174	38856	256
36231	169	36887	168	38627	253	38857	258
36233	169	36888	168	38631	260	38858	258
36234	169	36951	227	38632	260	38859	258
36235	169	36975	278	38633	254	38860	254
36236	169	36976	278	38636	259	38861	254
36237	169	36977	278	38637	252	38865	259
36238	169	36978	278	38649	234	38866	259
36239	169	36979	278	38650	234	38867	260
36240	169	36980	278	38651	234	38918	165
36272	278	36981	260	38652	234	38919	165
36275	234	36985	275	38653	234	38920	165
36280	234	36986	275	38654	234	38921	165
36282	234	36987	276	38656	234	38925	165
36285	234	36988	276	38657	234	38926	165
36288	234	36990	227	38658	234	38927	165
36310	230	37		38659	234	38928	165
36320	169	37067	303	38660	234	38929	165
36321	169	37137	112	38661	234	38930	165
36327	237	37147	137	38676	240	38931	165
36329	138	37147	167	38677	240	38932	165
36330	138	37222	137	38679	240	38933	165
36331	134	37222	167	38680	240	38934	165
36332	134	37223	137	38681	240	38935	165
36333	134	37223	167	38684	240	38936	165
36388	121	37224	137	38685	240	38937	279
36389	113	37224	167	38686	240	38938	279
36390	121	37225	137	38687	240	38981	268
36414	171	37225	167	38688	240	38982	268
36415	171	37226	137	38689	240	38983	268
36417	171	37226	167	38690	240	38984	254
36418	171	37227	137	38706	240	38985	264
36421	171	37227	167	38707	240	38986	264
36452	208	37351	197	38708	240	39	
36453	198	37352	197	38709	240	39008	299
36454	198	37402	273	38710	240	39010	299
36455	134	37403	273	38711	240	39012	299
36456	204	37450	260	38712	240	39014	299

Order-No.	
39017	299
39019	299
39021	299
39022	299
39027	279
39029	228
39037	228
39039	228
39040	228
39041	228
39045	228
39049	228
39056	228
39057	228
39059	229
39060	229
39061	229
39076	186
39078	228
39082	229
39083	229
39091	276
39093	276
39094	276
39095	276
39104	203
39105	203
39106	211
39107	211
39108	211
39109	211
39110	211
39111	211
39112	211
39113	211
39114	211
39115	211
39116	211
39117	211
39118	211
39124	228
39133	246
39134	246
39149	300
39150	300
39151	300
39152	300
39178	239
39179	239
39180	239
39181	239
39182	239
39183	239
39184	237
39185	237
39186	237
39187	237
39188	238
39189	238
39190	238
39191	238
39192	238
39193	238
39194	238
39195	238
39196	238
39197	238
39198	238
39199	238

Order-No.	
39200	238
39201	238
39202	238
39203	238
39204	238
39205	197
39206	239
39207	239
39208	239
39374	281
39375	281
39376	281
39377	281
39378	281
39379	281
39380	281
39381	281
39382	233
39875	232
39964	242
39971	241
40	
40282	116
40331	248
40342	265
40401	208
40402	208
40403	208
40404	208
40405	208
40406	208
40407	208
40408	208
40409	208
40410	199
40411	199
40461	236
40462	236
40463	236
40464	236
40465	236
40523	110
40600	241
40601	241
40602	241
40603	241
40604	241
40605	241
40606	241
40607	241
40608	241
40609	241
40610	241
40611	241
40612	241
40613	241
40614	241
40615	241
40616	241
40617	241
40618	241
40619	241
40620	241
40621	241
40622	241
40623	241
40624	241
40625	241
40626	241

Order-No.	
40627	241
40628	242
40629	242
40630	242
40631	242
40632	242
40633	242
40634	242
40635	242
40636	242
40637	242
40638	242
40639	242
40640	242
40641	242
40642	242
40643	242
40644	242
40645	242
40646	242
40647	242
40648	242
40649	242
40650	242
40651	242
40652	242
40653	242
40654	242
40655	242
40656	242
40657	242
40658	242
40659	242
40660	242
40661	242
40662	249
40663	242
40674	163
40709	257
40712	277
40713	277
40906	181
40913	269
40919	269
40920	269
40921	255
40922	255
40923	275
40927	257
40948	116
40966	211
40967	211
40968	211
40969	211
40970	211
40971	211
40972	211
40973	211
40974	211
40975	211
40976	211
40977	211
40978	211
40979	202
40980	202
41	
41002	142
41003	133
41015	287

Order-No.	
41141	138
41142	138
41143	138
41144	138
41145	138
41146	138
41147	138
41157	180
41158	180
41159	137
41159	167
41160	137
41160	167
41218	257
41219	257
41220	277
41221	277
41222	287
41223	115
41230	136
41231	132
41232	132
41233	132
41234	180
41235	180
41241	113
41245	134
41246	265
41261	269
41266	269
41272	269
41273	269
41274	255
41275	255
41277	269
41278	269
41279	255
41280	255
41286	128
41289	301
41301	269
41307	269
41308	269
41309	255
41310	255
41311	269
41317	269
41318	269
41319	255
41320	255
41321	269
41327	269
41328	269
41329	255
41330	255
41341	164
41342	164
41343	164
41344	164
41345	164
41384	181
41385	181
41476	164
41477	164
41478	164
41479	164
41483	196
41484	196
41585	226

Wiha order number register

Order-No.		Order-No.		Order-No.		Order-No.	
41586	226	41828	227	42127	222	42434	153
41587	226	41829	227	42128	222	42435	153
41588	226	41830	224	42129	222	42436	153
41589	226	41831	224	42130	222	42437	153
41590	226	41832	226	42131	222	42438	153
41591	226	41833	226	42132	222	42439	153
41592	226	41834	226	42133	222	42440	153
41593	226	41894	207	42134	222	42441	153
41594	226	41895	207	42135	223	42442	153
41595	226	41896	207	42136	223	42443	153
41596	226	41897	207	42137	223	42444	153
41597	226	41898	207	42138	223	42445	153
41598	225	41899	207	42139	223	42446	153
41599	225	41900	207	42149	224	42447	153
41600	225	41901	207	42150	224	42449	153
41601	225	41902	207	42162	262	42450	153
41602	225	41911	126	42210	136	42451	153
41603	225	41912	126	42210	166	42452	153
41604	225	41913	127	42211	136	42453	153
41605	225	41914	127	42211	166	42454	153
41606	225	41915	127	42212	136	42455	153
41607	225	41922	247	42212	166	42456	153
41608	225	41923	266	42213	136	42457	153
41609	225	41973	207	42213	166	42458	153
41610	225	41974	207	42214	136	42459	153
41611	225	41975	207	42214	166	42460	153
41612	225	41976	207	42374	140	42461	153
41613	225	41977	207	42375	140	42462	153
41614	225	41978	207	42376	140	42463	153
41621	225	41979	196	42377	140	42464	152
41622	225	41980	196	42378	140	42465	152
41623	225	42		42379	140	42466	152
41624	226	42062	262	42380	140	42467	152
41625	226	42068	303	42381	152	42468	152
41626	226	42069	108	42382	152	42469	152
41627	226	42071	301	42383	152	42470	152
41628	226	42074	302	42384	152	42471	140
41629	226	42086	129	42385	152	42474	152
41630	226	42096	224	42386	152	42475	152
41631	226	42097	222	42387	152	42476	152
41632	226	42098	223	42388	152	42477	152
41633	226	42099	222	42389	152	42478	152
41634	226	42100	224	42390	152	42479	152
41635	226	42101	224	42391	152	42480	152
41636	226	42102	224	42392	152	42481	152
41637	225	42103	224	42393	152	42482	152
41638	225	42104	224	42394	152	42483	152
41639	225	42105	224	42395	152	42484	152
41640	225	42106	224	42397	152	42485	152
41641	225	42107	224	42398	152	42486	152
41642	225	42108	224	42399	152	42487	152
41643	225	42109	224	42401	152	42488	152
41644	225	42110	224	42402	152	42489	152
41645	225	42111	224	42403	152	42490	152
41646	225	42112	224	42413	152	42491	152
41647	225	42113	224	42414	152	42492	152
41648	225	42114	222	42415	152	42493	152
41649	225	42115	222	42416	152	42494	152
41650	225	42116	222	42418	152	42501	152
41651	225	42117	222	42419	152	42502	152
41652	225	42118	222	42421	153	42503	152
41653	225	42119	222	42422	153	42504	152
41660	225	42120	222	42423	153	42505	152
41662	225	42121	222	42424	153	42506	152
41663	225	42122	222	42425	153	42507	153
41824	225	42123	222	42426	153	42989	136
41825	225	42124	222	42431	153	42990	145
41826	225	42125	222	42432	153	42991	145
41827	227	42126	222	42433	153	42992	145

Order-No.	
42993	145
42994	145
42996	145
42997	145
42998	145
43	
43022	118
43023	117
43024	117
43026	118
43027	118
43028	118
43029	118
43030	118
43031	118
43032	118
43033	118
43034	118
43035	118
43036	118
43037	118
43038	118
43039	118
43041	118
43042	118
43043	118
43044	118
43052	120
43053	120
43055	120
43056	120
43057	120
43058	120
43061	118
43062	119
43063	119
43065	119
43066	119
43067	119
43068	119
43069	119
43070	119
43071	119
43072	119
43073	119
43074	119
43075	119
43076	119
43077	119
43078	119
43079	119
43080	119
43081	119
43082	119
43083	119
43084	119
43085	119
43086	119
43087	119
43088	119
43089	119
43090	119
43091	119
43092	119
43093	119
43094	119
43095	119
43096	119
43097	119

Order-No.	
43098	119
43099	119
43100	120
43101	120
43102	120
43103	120
43104	120
43105	120
43106	120
43107	120
43108	120
43125	262
43128	166
43177	165
43240	273



Wiha article number register

Art.-No. 	Art.-No. 	Art.-No. 	Art.-No. 
22	277	284ESD T6 01	311ESD
2270P	277 K6	2850	311ESD
2271P	278	2850	312
227P	278 K6	2852	313
24	278IP	2852 S10	313
246	278R	2852 S10-01	3131
246 22 02	279-10	2859	313ESD
246 67	28	28590	313ESD
246 75 SB	2804	28591	314
246 76 SB	281 01	28592	32
246 77 SB	281 02	28593	3201
246 78 SB	281 B11	28594	3201 K12
246 80 SB	281 T11	28595	3201 K6
24618	281 T6	28595R	3201 K601
24619	281 T6 01	28596	3201 ZK6
246199	281-01ESD	28596R	320N
24636	2831 09 020	28597	320N K6
24636 B5	2831 09 021	285992	320N K7
25	2831 09 022	285994	320N ZK6 SO
255-11	2831 09 023	2872	3211
255-12	2831 T18	2872 S3	321N
255-3	2831 T9 01	2872 S3	322
255-7	2831 T9 02	2872 T13	322 K5
26	283100	2872 T18	323N
260P	2831-10	2879 B7	324
260P	2831-10	28799	3241
260P	2831-11	28799	325
261P	2831-11	2882	3251
262P	2831-12	2882 S10	3251 K6
263P	2831-12	2891	3251 TR
263P	2831-13	2893	3251 TR K6
264P	2831-13	2893 S01	327
264P Zoll	2831-14	2899	3271
265P	2831-14	2899	328
265P	2831-15	28993	3281
265P Zoll	2831-15	28995	33
266P	2831-15	28996	331
266PY	2831-17	28996	334
267P	2831-17	28999	334 VB
267P	2831-18	28999	334 Zoll
267P	2831-18	28999	334DS
267P	2831-B604	29	334DS K6
267P	2831-B604	2909101	334DSR
267P	2831-B605	2920	334N
267PIP	2831-B605	2933	334R
267PR	2831-B605	2970	334R VB
267PR	2831-B606	29701 080 S4	336
268P	2831-B606	29701 200 S4	336 Zoll
269	2831-B607	29701 280 S4	336N
269	2831-B607	29701 S5	338
269	2831-B607	30	34
269	2831-B608	300-2	341
269	2831-B608	301-2	341 K5
269	28352	302	343
269	28360	302	344
269	283693	302	347
269 T11	283695	302 HK 601	347 Zoll
269 T11 01	283696	302 HK12	35
269 T4	283793	302 HK6 SO	350
269 T6	283794	302 ZK6 SO	350 H7
269 T6 01	283795	3021	350 H9
2691	284	302ESD	351 PG7
2691 T11 ESD	284	302ESD	351 PG9X
2691ESD	284	302ESD HK5 01	351 PK7
27	284	308	352 H7B
272	284	308 HK6	352 H9B
272 K6	284	308 ZK6	352 HM5B
273	284	31	352B
274	284	311	356
275	284	311	
275 K6	284ESD	3111	
276			





Art.-No.	
357	148
3581	138
358N	139
36	
361IP	204
361IP	212
362	147
362 K6 SO	142
362 K7	142
362BE	146
362BE K6	142
362ESD	158
362ESD K5	157
362IP	147
362R	146
362R K6 SO	142
362RIP	147
362TR	147
362TR K6	142
363	203
363	211
363 H7	203
363 P7	184
363 P8	183
363 VB	205
363TR	204
363TR	212
363TR P7	184
363TR P8	184
364	217
364 VB	205
364DS	213
364DS K6	204
364IP	217
364R	217
365	218
365 VB	206
365IP	218
365IP VB	206
366	203
366	211
366 H7	203
366 TS	211
366BE	202
366BE	202
366BE	210
366BET	202
366BET	211
366R	201
366R	201
366R	201
366R	210
366TS	203
367	147
367R	147
369	197
369	198
369	198
369	199
369	199
369	208
369 Zoll B	209
369B	199
369B	199
369B	209
369F	196
369F	207
369K	199

Art.-No.	
369K	208
369R	197
369R	207
369R P7	185
369R Zoll	207
369RF	196
369RF	207
369RZ	197
369T	198
369T	208
369Z	208
369ZB	198
369ZB	199
37	
370	218
370 VB	206
370IP	218
371RIP	212
371RIP H8	204
371RIP HM7	204
372	149
38	
3801 01	182
3801 02	182
3801 03	182
3801 04	182
3803 02 020	182
3803 02 021	182
3803 04 007	181
3803 04 013	181
3809 01 01	182
3809 01 02	182
3809 01 03	182
384	248
386	248
387 01	248
387 02	248
387ESD	249
388	249
388DS	249
39	
397	150
398	150
40	
400 10	154
405	157
405 11	156
41	
410 1000	303
410 2000	303
410 2001	303
410 2005	303
410 2007	303
4102008	303
411 170 1	302
411 210 2	302
411 210 8	302
411 320 3	302
43	
430 40	154
50	
500	154
509	154
53	
530	150
530 HK6	144
530 ZK6	144
531	150
532	150

Art.-No.	
54	
540	214
540DS	213
55	
5520	155
5520 HK6	155
5520 ZK6	155
5521	155
5522	156
5525	156
5527	156
5527 K6	155
5528	156
5533	156
5533 HK5	155
5533 ZK5	155
5534	156
5535	156
5590N	118
5590N T20	118
59	
590 T101	126
590 T102	126
590 T103	127
599001	127
599002	127
70	
7000 4 Z	241
7000 EB16 ESD	192
7000 EB26 ESD	192
7000 SK65 ESD	241
7001 4 Z	241
7003 4 Z	241
7005 4 Z	242
7009 4 Z	242
7010 Z	231
7011 DWS	233
7011 DWS	235
7011 Z	231
7012 Z	231
7013 Z	232
7013 Z TR	232
7013R Z	232
7015 Z	231
7015 Z TR	231
7015K Z	231
7016 Z	231
7016 Z IPR	232
7017 Z	232
7017R Z	232
7018 Z	232
7019 Z SIT	232
7019 Z SP	232
7019 Z TS	232
7019 Z TW	233
7019 Z XZN	232
7040 Z	236
7041 Z	236
7042 Z	237
7043 Z	239
7043R Z	238
7044	244
7044 4 Z	242
7044 M	244
7045 Z	237
7045 Z TR	238
7045BE	237
7045BE 9570	240
7045R	237

Art.-No.	
7046 Z	238
7047R Z	238
7048 Z	239
7049 TS	239
7049XH	237
7049XZ	237
71	
710100	242
7103	242
7110 HM	248
7110M	242
7113	247
7113 P	247
7113 S	247
7113 S	247
7123	246
7140	247
7142	247
7143	247
7148 CF	246
7148 CS	246
7148C	246
7148ST	247
7183	248
72	
7201	245
7203	245
7204Z-516	245
7207N	119
7207N	120
7207N	120
7207N K2001	117
7208N	119
7208N	120
7208N	120
7208N K2001	117
7210	244
7240	245
73	
7311 Z	243
7312 Z	243
7321 Z	243
7322 Z	243
7325 Z	243
7331 Z	243
7332 Z	243
7341 Z	243
7342 Z	243
78	
7802	190
7803	190
7804	243
7805	243
7806	244
7807	244
79	
79186 B5	244
79187 B5	243
79187 T04	115
7928-913	229
7928-923	229
7928-928	230
7929 Z	235
7929 Z	235
7929 Z	235
7929 Z	235
7929 Z	235
7929 Z	235
7929 Z	235

Wiha article number register

Art.-No.		Art.-No.		Art.-No.		Art.-No.	
7929 Z	235	9300-030	112	Z 01 0 05	270	Z 32 0 10	277
7929 Z	235	9300-031	114	Z 01 0 06	256	Z 33 0 01	279
7929 Z	235	9300-035	113	Z 01 0 09	256	Z 33 1 01	279
7929 Z	235	9300-702	110	Z 01 0 16	257	Z 33 4 01	278
7929 Z	235	9300-704	108	Z 02 0 01	271	Z 33 5 01	278
7929 Z	235	SB		Z 02 0 02	271	Z 34 0 01	279
7930 Z	236	SB 246 01	186	Z 02 0 05	271	Z 34 1 01	279
7930 Z	236	SB 246 02	186	Z 02 0 06	256	Z 34 4 01	278
7930 Z	236	SB 246 70	128	Z 02 0 09	256	Z 34 5 01	278
7930 Z	236	SB 246 81	186	Z 02 2 01	257	Z 36 0 01	273
7930 Z	236	SB 255-11	141	Z 02 2 02	257	Z 36 0 03	287
7945	227	SB 255-12	141	Z 05 0 01	272	Z 36 0 04	285
7947-005	228	SB 255-3	141	Z 05 0 02	272	Z 36 1 03	287
7947-505	228	SB 255-7	141	Z 05 0 05	271	Z 36 1 04	285
7947-505TR	228	SB 2831 0101	136	Z 05 0 06	258	Z 37 0 04	285
7947-902	228	SB 3021 S2	144	Z 05 0 09	258	Z 38 0 04	285
7947-904	228	SB 3201 S201	134	Z 05 1 01	273	Z 40 0 03	286
7947-905	228	SB 3201 S202	134	Z 05 1 02	272	Z 40 1 03	286
7947-995	228	SB 3201 S204	134	Z 05 1 05	272	Z 40 1 04	283
7947-999	228	SB 327 S2	135	Z 05 1 06	258	Z 40 3 04	283
7948-005	227	SB 328 S2	135	Z 05 1 09	258	Z 40 4 04	283
7948-043	227	SB 351 PM8X	183	Z 06 0 16	257	Z 41 1 03	286
7948-927	227	SB 3803 04 02001	181	Z 07 0 01	274	Z 41 1 04	283
7979-01	230	SB 400 10	154	Z 07 0 02	274	Z 41 3 03	286
7979-02	230	SB 430 40 K10	154	Z 07 0 05	274	Z 41 3 04	283
7979-03	230	SB 430 40 K1020	154	Z 07 0 06	259	Z 41 4 04	283
80		SB 430 4010	154	Z 09 0 01	274	Z 41 6 03	286
800	299	SB 534S5	301	Z 09 0 02	274	Z 43 1 04	284
800	299	SB 7945-TY202	223	Z 09 0 05	274	Z 44 1 04	284
8001	299	SB 7945-TY303	223	Z 09 0 06	259	Z 44 3 01	273
8001K	300	SB 7945-TY505	223	Z 12 0 01	269	Z 44 3 04	284
800K	300	SB 7945-TY903	223	Z 12 0 02	268	Z 46 0 03	286
800S	300	SB 7945-TY904	223	Z 12 0 05	268	Z 46 0 03	287
802	299	SB 7945-TY905	223	Z 12 0 06	254	Z 46 1 04	284
8021	299	SB 7946-TY202	222	Z 12 0 09	254	Z 46 4 04	284
82		SB 7946-TY303	222	Z 14 0 06	254	Z 47 1 04	284
829-0	298	SB 7946-TY505	222	Z 14 1 01	253	Z 47 2 04	285
83		SB 7946-TY903	222	Z 14 1 06	253	Z 49 2 03	287
830-0	298	SB 7946-TY904	222	Z 15 0 01	273	Z 49 7 03	287
831-1	297	SB 7946-TY905	222	Z 16 2 01	269	Z 50 1 01	260
831-3	297	SB 7947-005	228	Z 16 3 02	269	Z 50 1 06	259
831-5	297	SB 7947-505	228	Z 16 3 05	269	Z 50 1 09	259
831-8	297	SB 7947-505TR	228	Z 16 3 06	255	Z 55 0 01	261
831-9	298	SB 7947-902	229	Z 16 3 09	255	Z 55 0 02	261
832 B8	294	SB 7947-904	229	Z 17 0 01	276	Z 55 0 05	261
832-13	295	SB 7947-905	229	Z 18 0 01	268	Z 55 0 06	260
832-15	295	SB 7947-995	229	Z 18 0 02	268	Z 55 0 09	260
832-33	295	SB 7947-999	229	Z 18 0 05	268	Z 57 0 001 06K	262
832-35	295	SB 7947-T303	225	Z 18 0 06	254	Z 57 0 06 SB	262
832-38	296	SB 7947-T906	225	Z 21 0 01	275	Z 60 0 01	264
832-39	296	SB 7947-T999	225	Z 21 0 02	275	Z 60 0 01	264
832-55	296	SB 7947-Y202	227	Z 21 0 05	275	Z 60 0 06	264
832-99	296	SB 7947-Y505	227	Z 21 0 06	260	Z 60 0 06	264
833-1	297	SB 7947-Y904	227	Z 22 0 01	276	Z 62 0 001 06	265
833-5	297	SB 7948-T950	224	Z 22 0 02	276	Z 62 0 002 06	265
834-15	295	SB 7948-T999	224	Z 22 0 05	276	Z 62 0 003 06	265
84		SB 7948-Y505	226	Z 22 0 06	260	Z 62 0 004 06	265
846	301	SB 7948-Y904	226	Z 23 1 01	276	Z 62 0 005 06 SB	265
93		SB 7948-Y950	226	Z 23 1 05	276	Z 65 0 05	280
9300-012-01	116	SB246176	262	Z 25 0 01	275	Z 65 2 05	280
9300-013-02	116	SB24628	249	Z 26 0 00	280	Z 66 0 00	280
9300-015	123	SB24629	249	Z 26 1 00	280	Z 71 5 06	266
9300-016	123	U		Z 26 2 00	280	Z 71 7 160 06 SB	266
9300-018	114	U 106	190	Z 27 0 01	281	Z 99 0 001 01	266
9300-019	122	U106 T12	188	Z 27 0 01K	281	Z 99 0 001 04	282
9300-020	122	U106 T8	188	Z 30 0 01	277	Z 99 0 001 06	252
9300-024	121	Z		Z 31 0 00	277	Z 99 0 001 09	252
9300-025	113	Z 01 0 01	270	Z 31 0 01	277	Z 99 0 002 01	266
9300-026	121	Z 01 0 02	270	Z 32 0 01	277	Z 99 0 002 05	267

Art.-No.	
Z 99 0 002 06	115
Z 99 0 004 01	267
Z 99 0 006 02	123
Z 99 0 007 01	267
ZP	
ZP 01 0 14	288
ZP 06 0 14	288
ZP 07 1 14	288
ZP 09 0 14	288
ZP 11 0 14	288
ZP 15 0 14	288
ZP 16 0 14	288
ZP 18 0 14	288
ZP 20 1 14	289
ZP 20 2 14	289
ZP 24 0 14	289
ZP 25 2 14	289
ZP 46 0 14	289
ZP 50 0 14	289
ZP 99 0 140 02	282



Notes



Legend

Drives

	Triangular nut
	Hex
	Square nut
	Hexagon socket
	Internal hexagon with drill hole (tamper-resistant)
	Tamper Resistant hex
	Countersink
	Combination drill bit
	Pentalobe PL
	Y-Type
	Phillips PH (cross-recessed)
	Pozidriv PZ (Phillips)
	Robertson
	Round tip
	Slotted
	Slotted nut
	SIT
	Spanner
	Twist drill
	Sliding sleeve
	Torq-Set®
	TORX®
	TORX® with drill hole (tamper-resistant)
	TORX PLUS®
	Tri-Wing®
	Multitooth
	Square reaming blade
	Xeno SL/PZ

Drives

	Square nut
	Square
	G7 drive system
	Threaded connector
	SDS-Plus®
	Hex

Screwdrivers [mm]

	Cut width
	Tip width
	Round blade dimension
	Hex blade
	Hex_bolster
	Scraper width
	Clip opening
	Tip width
	Head width, nut driver
	Blade length
	Shaft lengths
	Handle length
	Handle diameter
	Torque T-handle length
	Torque T-handle width
	Max. torque value [Nm]
	Max. torque value [in.lbs]
	Accuracy [%]
	Cable key depth

L-keys [mm]

	Round blade dimension
	Hex blade
	Hex bolster
	Shaft lengths
	Blade length
	Side driver length T-handle
	Handle width
	Diameter

Bits [mm]

	Threaded connector
	Drill working length
	Screw size

Pliers [mm]

	Flat jaws
	Half round jaws
	Round jaws
	Cutter without bevel
	Cutter with small bevel
	Cutter with bevel
	Anvil cutter
	Center cutter
	Scissors cutter
	Front cutting edge in stripping pliers
	Max. diameter
	Max. cross-section
	Max. gripper pipe diameter
	Max. gripper width across flats
	External retaining ring
	Internal retaining ring
	Clamping range
	Opening width flat
	Cutting force
	with opening spring
	American Wire Gauge
	Saw blade length

Measurement tools [mm]

	Width of segments
	Colour
	Measurement capacity [mm]
	Measurement capacity in Inch

Electro

	Battery
	LED lumens
	Laser light

Soft faced hammer [mm]

	Face diameter
	Hammer face width
	Hammer head width

General symbols

	Weight, g
	Diameter
	Blister packed
	Total length
	Total length in inch

TORX®, TORX PLUS®= Registered Trademarks of ACUMENT GlobalTechnologies B.V.
 ACR/AOT, Tri-Wing®, Torq-Set®= Registered Trademarks of Phillips Screw Company
 Pozidriv= Registered Trademark of European Industrial Services Ltd.

Legend

Ranges



Case strength



Wheel-along case



Case shape



Case suitable for transport by air

Elektro



Torque safety check



Saves time

Screwdrivers



MagicRing®



MagicSpring®



Ball end can swivel up to 25°



slimTECHNOLOGY

Torque



Precision: ±6%



Accuracy ±10%



slimTECHNOLOGY

L-keys



MagicRing®



MagicSpring®



Ball end can swivel up to 25°



TORX® ball end; can swivel up to 25°



Visible in UV light

Bits



Suitable for impact screwdrivers



Lifespan 120 times longer



Visible in UV light

Pliers



Cutting-to-length diameter



Skinning diameter length



Automatic skinning



DynamicJoint®



Heavy-duty diagonal cutters



OptiGrip



MagicTips®



BiCut® Power



TriCut



Inomic®

Impact tools



Optimum weight distribution



Soft hammer end



Levers out nail clamp

Measurement tool



Fully enclosed



Visible from just 10°



Visible in UV light

General information



Recommended for electricians – non-insulated



VDE-tested and certified



CE marking



ESD electronics mark

Subject to technical changes. All illustrations and graphics, specified dimensions and values and references to standards, e.g. DIN/EN, are non-binding. Any liability claims based on this will therefore be rejected. No liability claims will be accepted for printing errors and mistakes which have occurred during the production of the catalogue. All property rights to the catalogue held by Wiha Werkzeuge GmbH are reserved. The printing or copying of the texts and illustrations contained in this catalogue or its design is prohibited. Our General Terms and Conditions (Terms of Sale, Delivery and Payment) apply.

You will find our general terms and conditions at www.wiha.com

Wiha Werkzeuge GmbH
Obertalstraße 3-7

78136 Schonach/Germany
Phone +49 7722 959-0
Fax +49 7722 959-159 Inland
Fax +49 7722 959-155 Export
info.de@wiha.com
www.wiha.com

Wiha Tools Ltd.

17 The Courtyard
Buntsford Gate
Bromsgrove B60 3DJ
Phone +44 1527 57 57 58
+44 1527 91 09 86
Fax +44 1527 91 00 23
info.uk@wiha.com
www.wiha.com/en

Wiha France SARL

Z. A. de Terrefort
33520 Bruges/France
Phone +33 5 56 16 79 35
Fax +33 5 56 16 79 36
servicecommercial@wiha.fr
www.wiha.com/fr

Wiha Nordic A/S

Korskildelund 6
2670 Greve/Denmark
Phone +45 70 23 80 45
info.nordic@wiha.com
www.wiha.com

Wiha Iberia Willi Hahn S.A.

Av. del Rey Juan Carlos I, 98. 3°C
28916 Leganés/Madrid, Spain
Phone +34 91 693 85 11
Fax +34 91 693 63 83
iberia@wiha.com
www.wiha.com/es

Wiha Polska Sp. z o.o.

ul. Budowlanych 10b
80-298 Gdańsk/Poland
Phone +48 58 762 38 30
Fax +48 58 762 39 00
info.pl@wiha.com
www.wiha.com/pl

Wiha in Russia

Phone +48 58 762-38-30
Fax +48 58 762-39-00
michal.moczynski@wiha.com
www.wiha.com

Willi Hahn Corp.

1348, Dundas Circle
Monticello, MN 55362/USA
Phone +1 763 2 95 65 91
Fax +1 763 2 95 65 98
cservice@wihatools.com
www.wihatools.com

Wiha Tools Canada Ltd.

394 Deerpark Drive
L6T 5H9, Brampton, ON
Phone +1 866 494 0096
Fax +1 800 494 7456
info@wihatools.ca
www.wihatools.ca

Wiha Asia Pacific Pte. Ltd.

25 International Business Park
#02-102 German Centre
Singapore 609916
Phone +65 6563 1277
Fax +65 6563 7168
info.sg@wiha.com
www.wiha.com

Wiha Tools (Shanghai) Co.Ltd.

Zone B No.1000
Jinsui Road Pudong
New District
Shanghai 201206
China
Phone +86 21 6440 1119
Fax +86 21 6440 1112
info@wiha.com.cn
www.wiha.com.cn

Wiha Finland Oy

Mäkituvantie 9
FI-01510 Vantaa Finland
Phone +358 44 231 9988
raija.helin@wiha.com
www.wiha.com

Wiha en Belgique

Phone +32 49 35 054 50
info.belux@wiha.com
www.wiha.com

Wiha in Nederland

Phone +31 64 63 113 30
info.nl@wiha.com
www.wiha.com/nl

Wiha in Italia

Thoelke Rappresentanze Srl
Phone +39-0332-966039
info.it@wiha.com
www.wiha.com/it

Premium Tools Australia Pty Ltd.

PO Box 63
Bargo, NSW 2574
Phone +61 02 4664 1460
Fax +61 02 8088 7272
sales@wiha.com.au
www.wiha.com.au

Premium Tools (NZ) Ltd.

Unit 5C 89 Ellice Road
Wairau Valley
Auckland, New Zealand
Phone +64 09 444 2560
Fax +64 09 355 0411
sales@wiha.co.nz
www.wiha.co.nz

Robert Rieffel AG

Widenholzstrasse 8
8304 Wallisellen/Switzerland
Phone +41 44 877 33 33
Fax +41 44 877 33 22
info@rieffel.ch
www.rieffel.ch