

Plug - PP-H 2,5/10 - 3209950

Please be informed that the data shown in this PDF Document is generated from our Online Catalog. Please find the complete data in the user's documentation. Our General Terms of Use for Downloads are valid (<http://phoenixcontact.com/download>)



Plug, nom. voltage: 500 V, nominal current: 24 A, connection method: Push-in connection, number of connections: 10, number of positions: 10, cross section: 0.14 mm² - 4 mm², AWG: 26 - 12, width: 52 mm, height: 40.2 mm, color: gray

Why buy this product

- Large-surface labeling option
- The Push-in technology COMBI plugs for self-assembly provide solutions that users can implement themselves
- Tested for railway applications

Key Commercial Data

Packing unit	1 STK
GTIN	 4 046356 366847
GTIN	4046356366847
Weight per Piece (excluding packing)	33.600 g
Custom tariff number	85366990
Country of origin	Poland

Technical data

General

Number of positions	10
Number of levels	1
Number of connections	10
Potentials	1
Nominal cross section	2.5 mm ²
Color	gray
Insulating material	PA

Plug - PP-H 2,5/10 - 3209950

Technical data

General

Flammability rating according to UL 94	V0
Area of application	Railway industry
	Machine building
	Plant engineering
Maximum load current	24 A (with a 2.5 mm ² conductor cross section)
Rated surge voltage	6 kV
Degree of pollution	3
Overvoltage category	III
Insulating material group	I
Maximum power dissipation for nominal condition	0.77 W
Maximum load current	24 A (with 4 mm ² conductor cross section)
Nominal current I _N	24 A
Nominal voltage U _N	500 V
Open side panel	No
Relative insulation material temperature index (Elec., UL 746 B)	130 °C
Temperature index of insulation material (DIN EN 60216-1 (VDE 0304-21))	130 °C
Static insulating material application in cold	-60 °C
Behavior in fire for rail vehicles (DIN 5510-2)	Test passed
Flame test method (DIN EN 60695-11-10)	V0
Oxygen index (DIN EN ISO 4589-2)	>32 %
NF F16-101, NF F10-102 Class I	2
NF F16-101, NF F10-102 Class F	2
Surface flammability NFPA 130 (ASTM E 162)	passed
Specific optical density of smoke NFPA 130 (ASTM E 662)	passed
Smoke gas toxicity NFPA 130 (SMP 800C)	passed
Calorimetric heat release NFPA 130 (ASTM E 1354)	28 MJ/kg
Fire protection for rail vehicles (DIN EN 45545-2) R22	HL 1 - HL 3
Fire protection for rail vehicles (DIN EN 45545-2) R23	HL 1 - HL 3
Fire protection for rail vehicles (DIN EN 45545-2) R24	HL 1 - HL 3
Fire protection for rail vehicles (DIN EN 45545-2) R26	HL 1 - HL 3

Dimensions

Width	52 mm
Length	15.8 mm
Height	40.2 mm
	24 mm
Pitch	5.2 mm

Plug - PP-H 2,5/10 - 3209950

Technical data

Connection data

Connection method	Push-in connection
Connection in acc. with standard	IEC 61984
Conductor cross section solid min.	0.14 mm ²
Conductor cross section solid max.	4 mm ²
Conductor cross section AWG min.	26
Conductor cross section AWG max.	12
Conductor cross section flexible min.	0.14 mm ²
Conductor cross section flexible max.	2.5 mm ²
Min. AWG conductor cross section, flexible	26
Max. AWG conductor cross section, flexible	14
Conductor cross section flexible, with ferrule without plastic sleeve min.	0.14 mm ²
Conductor cross section flexible, with ferrule without plastic sleeve max.	2.5 mm ²
Conductor cross section flexible, with ferrule with plastic sleeve min.	0.14 mm ²
Conductor cross section flexible, with ferrule with plastic sleeve max.	2.5 mm ²
2 conductors with same cross section, stranded, TWIN ferrules with plastic sleeve, max.	0.5 mm ²
Stripping length	8 mm ... 10 mm
Internal cylindrical gage	A3

Standards and Regulations

Connection in acc. with standard	CSA
	IEC 61984
Flammability rating according to UL 94	V0
Fire protection for rail vehicles (DIN EN 45545-2) R22	HL 1 - HL 3 HL 1 - HL 3 HL 1 - HL 3 HL 1 - HL 3
Fire protection for rail vehicles (DIN EN 45545-2) R23	HL 1 - HL 3 HL 1 - HL 3 HL 1 - HL 3 HL 1 - HL 3
Fire protection for rail vehicles (DIN EN 45545-2) R24	HL 1 - HL 3 HL 1 - HL 3 HL 1 - HL 3 HL 1 - HL 3
Fire protection for rail vehicles (DIN EN 45545-2) R26	HL 1 - HL 3 HL 1 - HL 3 HL 1 - HL 3 HL 1 - HL 3

Environmental Product Compliance

China RoHS	Environmentally friendly use period: unlimited = EFUP-e
	No hazardous substances above threshold values

Drawings

Plug - PP-H 2,5/10 - 3209950

Circuit diagram

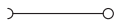

Diagram

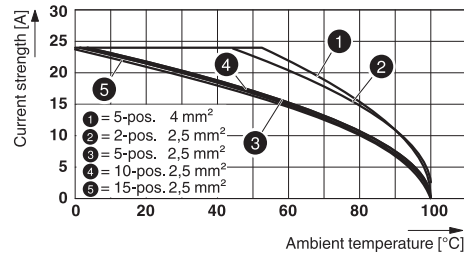

Schematic diagram

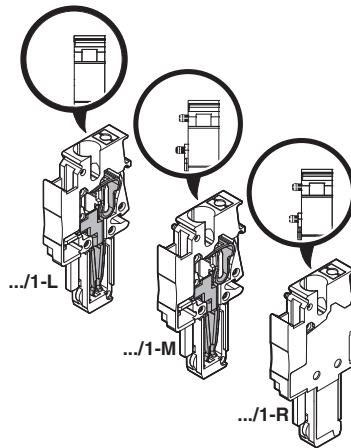

Classifications

eCl@ss

eCl@ss 4.0	272607xx
eCl@ss 4.1	27260701
eCl@ss 5.0	27260701
eCl@ss 5.1	27260701
eCl@ss 6.0	27141151
eCl@ss 7.0	27141151
eCl@ss 8.0	27141151
eCl@ss 9.0	27141151

ETIM

ETIM 2.0	EC000897
ETIM 3.0	EC000897
ETIM 4.0	EC002021
ETIM 5.0	EC002021
ETIM 6.0	EC002021

Plug - PP-H 2,5/10 - 3209950

Classifications

UNSPSC

UNSPSC 6.01	30211802
UNSPSC 7.0901	39121402
UNSPSC 11	39121402
UNSPSC 12.01	39121402
UNSPSC 13.2	39121402

Approvals

Approvals

Approvals

CSA / LR / ABS / NK / UL Recognized / cUL Recognized / BV / EAC / EAC / DNV GL / cULus Recognized

Ex Approvals

Approval details

CSA		http://www.csagroup.org/services-industries/product-listing/	13631
	B	C	
mm ² /AWG/kcmil	26-12	26-12	
Nominal current IN	20 A	20 A	
Nominal voltage UN	300 V	300 V	

LR		http://www.lr.org/en	10/20040
----	---	---	----------

ABS		http://www.eagle.org/eagleExternalPortalWEB/	16-HG1591536-PDA
-----	---	---	------------------

NK		http://www.classnk.or.jp/hp/en/	14ME0912
----	---	---	----------

Plug - PP-H 2,5/10 - 3209950

Approvals

UL Recognized		http://database.ul.com/cgi-bin/XYV/template/LISEXT/1FRAME/index.htm	FILE E 60425
	B	C	D
mm ² /AWG/kcmil	26-12	26-12	26-12
Nominal current IN	20 A	20 A	5 A
Nominal voltage UN	300 V	300 V	600 V

cUL Recognized		http://database.ul.com/cgi-bin/XYV/template/LISEXT/1FRAME/index.htm	FILE E 60425
	B	C	D
mm ² /AWG/kcmil	26-12	26-12	26-12
Nominal current IN	20 A	20 A	5 A
Nominal voltage UN	300 V	300 V	600 V

BV		http://www.veristar.com/portal/veristarinfo/generalinfo/approved/approvedProducts/equipmentAndMaterials	25278/B0 BV
----	---	---	-------------

EAC		EAC-Zulassung
-----	---	---------------

EAC		7500651.22.01.00246
-----	---	---------------------

DNV GL	http://exchange.dnv.com/tari/	TAE00000UD_01
--------	---	---------------

cULus Recognized		http://database.ul.com/cgi-bin/XYV/template/LISEXT/1FRAME/index.htm
------------------	---	---

Accessories

Accessories

Cable housing

Plug - PP-H 2,5/10 - 3209950

Accessories

Cable housing - PH 2,5/ 2 - 3209691



Cable housing, pitch: 10.4 mm, length: 19.9 mm, width: 10.4 mm, height: 36.8 mm, number of positions: 2, color: gray

Cable housing - PH 2,5/ 3 - 3209701



Cable housing, pitch: 15.6 mm, length: 19.9 mm, width: 15.6 mm, height: 36.8 mm, number of positions: 3, color: gray

Cable housing - PH 2,5/ 4 - 3209714



Cable housing, pitch: 20.8 mm, length: 19.9 mm, width: 20.8 mm, height: 36.8 mm, number of positions: 4, color: gray

Cable housing - PH 2,5/ 5 - 3209727



Cable housing, pitch: 26 mm, length: 19.9 mm, width: 26 mm, height: 36.8 mm, number of positions: 5, color: gray

Cable housing - PH 2,5/ 6 - 3209730



Cable housing, pitch: 31.2 mm, length: 19.9 mm, width: 31.2 mm, height: 36.8 mm, number of positions: 6, color: gray

Plug - PP-H 2,5/10 - 3209950

Accessories

Cable housing - PH 2,5/ 7 - 3209743



Cable housing, pitch: 36.4 mm, length: 19.9 mm, width: 36.4 mm, height: 36.8 mm, number of positions: 7, color: gray

Cable housing - PH 2,5/ 8 - 3209756



Cable housing, pitch: 41.6 mm, length: 19.9 mm, width: 41.6 mm, height: 36.8 mm, number of positions: 8, color: gray

Cable housing - PH 2,5/ 9 - 3209507



Cable housing, pitch: 46.8 mm, length: 19.9 mm, width: 46.8 mm, height: 36.8 mm, number of positions: 9, color: gray

Cable housing - PH 2,5/10 - 3209769



Cable housing, pitch: 52 mm, length: 19.9 mm, width: 52 mm, height: 36.8 mm, number of positions: 10, color: gray

Cable housing - PH 2,5/11 - 3209772



Cable housing, pitch: 57.2 mm, length: 19.9 mm, width: 57.2 mm, height: 36.8 mm, number of positions: 11, color: gray

Plug - PP-H 2,5/10 - 3209950

Accessories

Cable housing - PH 2,5/12 - 3209785



Cable housing, pitch: 62.4 mm, length: 19.9 mm, width: 62.4 mm, height: 36.8 mm, number of positions: 12, color: gray

Cable housing - PH 2,5/13 - 3209798



Cable housing, pitch: 67.6 mm, length: 19.9 mm, width: 67.6 mm, height: 36.8 mm, number of positions: 13, color: gray

Cable housing - PH 2,5/14 - 3209808



Cable housing, pitch: 72.8 mm, length: 19.9 mm, width: 72.8 mm, height: 36.8 mm, number of positions: 14, color: gray

Cable housing - PH 2,5/15 - 3209811



Cable housing, pitch: 78 mm, length: 19.9 mm, width: 78 mm, height: 36.8 mm, number of positions: 15, color: gray

End cover

Flange cover - DF-SP-H 2,5 - 3209824



Flange cover, length: 35.8 mm, width: 4.5 mm, height: 24.7 mm, color: gray

Plug - PP-H 2,5/10 - 3209950

Accessories

Flange

Flange cover - DFS-SP-H 2,5 - 3061431



Flange cover, length: 35.8 mm, width: 4.5 mm, height: 24.7 mm, color: gray

Insulating sleeve

Insulating sleeve - MPS-IH WH - 0201663

Insulating sleeve, color: white



Insulating sleeve - MPS-IH RD - 0201676

Insulating sleeve, color: red



Insulating sleeve - MPS-IH BU - 0201689

Insulating sleeve, color: blue



Insulating sleeve - MPS-IH YE - 0201692

Insulating sleeve, color: yellow



Plug - PP-H 2,5/10 - 3209950

Accessories

Insulating sleeve - MPS-IH GN - 0201702

Insulating sleeve, color: green



Insulating sleeve - MPS-IH GY - 0201728

Insulating sleeve, color: gray



Insulating sleeve - MPS-IH BK - 0201731

Insulating sleeve, color: black



Insulating sleeve - ISH 2,5/0,2 - 3002843

Insulating sleeve, color: white



Insulating sleeve - ISH 2,5/0,5 - 3002856

Insulating sleeve, color: gray



Plug - PP-H 2,5/10 - 3209950

Accessories

Insulating sleeve - ISH 2,5/1,0 - 3002869



Insulating sleeve, color: black

Mounting material

Latching - PR - 3040559



Latching, length: 29.8 mm, width: 10 mm, number of positions: 1, color: orange

Latching - PR/2 - 3040630



Latching, length: 29.8 mm, width: 10 mm, number of positions: 2, color: orange

Latching - PRT/2 - 3040631



Latching, can only be released using a screwdriver, length: 23.2 mm, width: 9 mm, number of positions: 2, color: orange

Latching - PRZ - 3040614



Latching, length: 63.6 mm, width: 9.7 mm, number of positions: 2, color: orange

Plug - PP-H 2,5/10 - 3209950

Accessories

Screwdriver tools

Screwdriver - ST-BW - 1207608



Actuation tool, for all 2.5 mm² - 4.0 mm² spring-cages

Shield connection

Shield connection clip - PSH 3- 6 - 3040591



Shield connection clip, color: black

Shield connection clip - PSH 5-10 - 3040601



Shield connection clip, color: black

Strain relief

Strain relief - PZ/2 - 3040627



Strain relief, length: 48.7 mm, width: 9.3 mm, number of positions: 2, color: black

Plug - PP-H 2,5/10 - 3209950

Accessories

Strain relief - PZ/4 - 3040643



Strain relief, length: 48.7 mm, width: 19.6 mm, number of positions: 4, color: black

Test plug terminal block

Test plugs - MPS-MT - 0201744



Test plugs, with solder connection up to 1 mm² conductor cross section, color: silver