

2-stage filter for 3-phase systems

new



See below:

**Approvals and Compliances**

**Description**

- Terminals for three phases, neutral conductor and ground
- 2 stage
- Very high attenuation
- Industrial or low leakage current versions

**Unique Selling Proposition**

- Compact design with small footprint
- Double-stage filter for high attenuation
- Light weight design
- Wide temperature range

**Applications**

- Voltage rating 520 or 760 VAC for various applications
- Protection against interference voltage from the mains
- Especially designed for industrial applications such as: Frequency Converters, Stepper Motor Drives, UPS-Systems, Inverters
- Suitable for use in equipment according to IEC/UL 62368-1

**Weblinks**

[pdf data sheet](#), [html datasheet](#), [General Product Information](#), [Approvals](#), [Distributor-Stock-Check](#), [Detailed request for product](#), [Microsite](#)

**Technical Data**

|                         |  |
|-------------------------|--|
| Rated Current           | 16 - 230A  |
| Rated voltage           | 520/760VAC, 50/60 Hz   |
| Approval for            | 16 - 230A @ 50 °C / 520/760VAC;<br>50/60Hz   |
| Overload Current        | 1.5 x I <sub>r</sub> for 1 minute, per hour  |
| Dielectric Strength     | > 520V / 2.25 kVDC between L-L<br>> 520V / 2.75 kVDC between L-PE<br>> 760V / 3.27 kVDC between L-L<br>> 760V / 3.20 kVDC between L-PE<br>Test voltage 2 sec |
| Number of Filter Stages | 2-stage  |
| Weight                  | 1 - 5.9kg  |
| Material: Housing       | Metal  |
| Sealing Compound        | UL 94V-0   |

|                       |   |
|-----------------------|---|
| Mounting              | Screw-on mounting on chassis                                      |
| Terminal              | Screw clamps  |
| Operating Temperature | -40°C to 100°C  |
| Climatic Category     | 40/100/21 acc. to IEC 60068-1                                     |
| Degree of Protection  | IP20 acc. to IEC 60529  |
| Protection Class      | Suitable for appliances with protection class I acc. to IEC 61140 |
| MTBF                  | > 200'000h acc. to MIL-HB-217 F                                   |

**Approvals and Compliances**

Detailed information on product approvals, code requirements, usage instructions and detailed test conditions can be looked up in [Details about Approvals](#)

SCHURTER products are designed for use in industrial environments. They have approvals from independent testing bodies according to national and international standards. Products with specific characteristics and requirements such as required in the automotive sector according to IATF 16949, medical technology according to ISO 13485 or in the aerospace industry can be offered exclusively with customer-specific, individual agreements by SCHURTER.

**Approvals**

The approval mark is used by the testing authorities to certify compliance with the safety requirements placed on electronic products.

Approval Reference Type: FMBD NEO

| Approval Logo | Certificates                  | Certification Body | Description                  |
|---------------|-------------------------------|--------------------|------------------------------|
|               | <a href="#">VDE Approvals</a> | VDE                | Certificate Number: 40053230 |
|               | <a href="#">UL Approvals</a>  | UL                 | UL File Number: E495089      |

**Product standards**

Product standards that are referenced

| Organization   | Design                | Standard  | Description  |
|--|-----------------------|-----------|--|
|  | Designed according to | IEC 60939 | Passive filters for suppressing electromagnetic interference |
|  | Designed according to | UL 1283   | Electromagnetic interference filters                         |

**Application standards**

Application standards where the product can be used

| Organization   | Design                         | Standard       | Description   |
|--|--------------------------------|----------------|---|
|  | Designed for applications acc. | IEC/UL 62368-1 | Audio/video, information and communication technology equipment - Part 1: Safety requirements |

**Compliances**

The product complies with following Guide Lines

| Identification   | Details                                      | Initiator   | Description   |
|--|--|-------------|---|
|  | <a href="#">CE declaration of conformity</a> | SCHURTER AG | The CE marking declares that the product complies with the applicable requirements laid down in the harmonisation of Community legislation on its affixing in accordance with EU Regulation 765/2008. |
|  | RoHS   | SCHURTER AG | Directive RoHS 2011/65/EU, Amendment (EU) 2015/863  |
|  | China RoHS                                   | SCHURTER AG | The law SJ / T 11363-2006 (China RoHS) has been in force since 1 March 2007. It is similar to the EU directive RoHS.  |
|  | REACH  | SCHURTER AG | On 1 June 2007, Regulation (EC) No 1907/2006 on the Registration, Evaluation, Authorization and Restriction of Chemicals 1 (abbreviated as "REACH") entered into force.                               |

**Dimension [mm]**

Case 5A-4

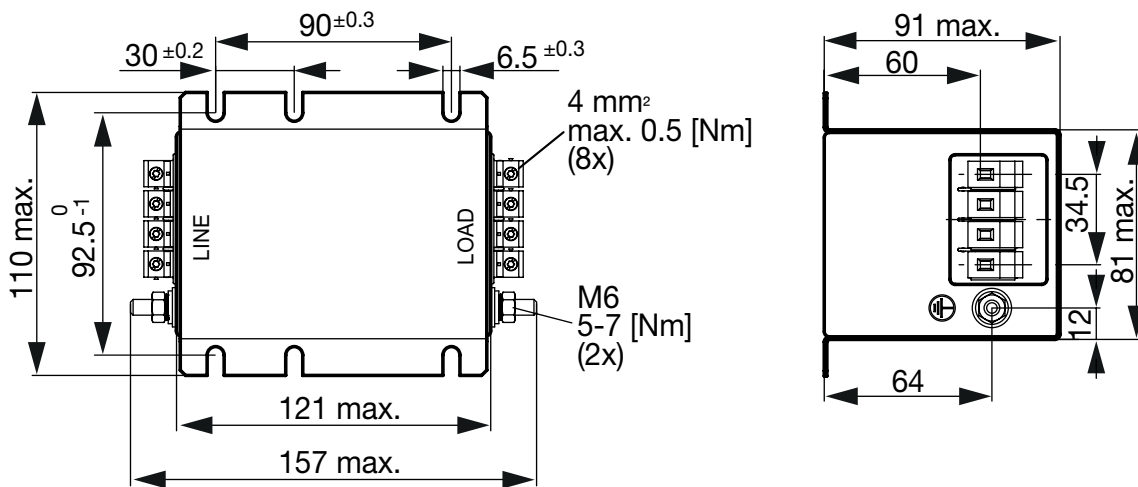

Case 5A-10

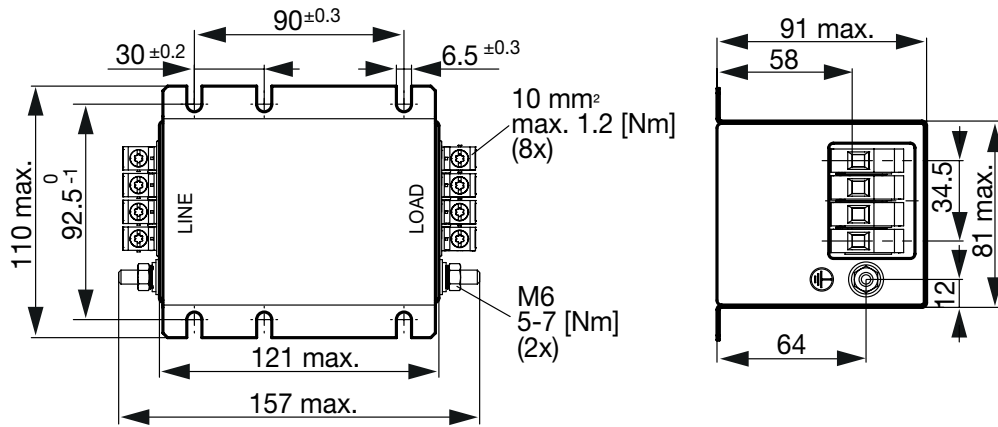

Case 5B-10

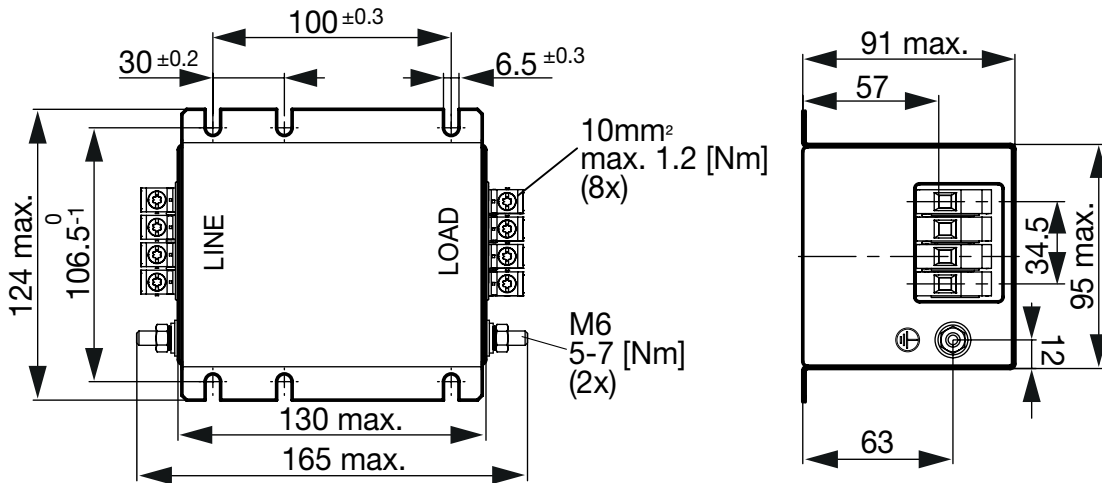

Case 5B-16

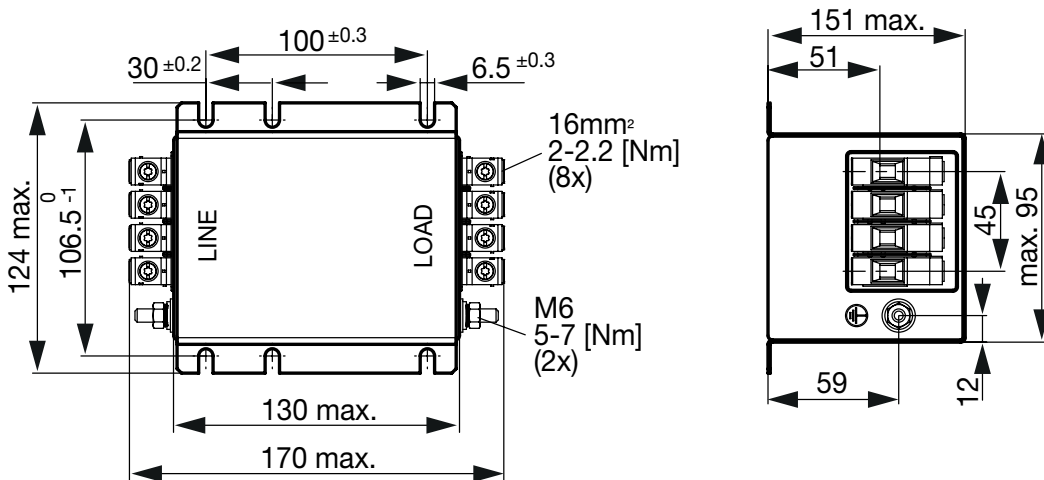

Case 5C-25

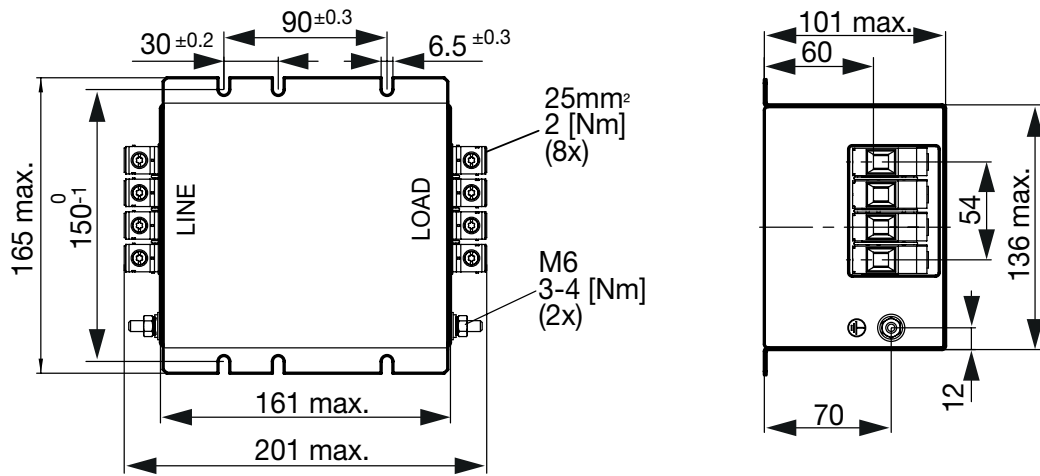

Case 5C-50

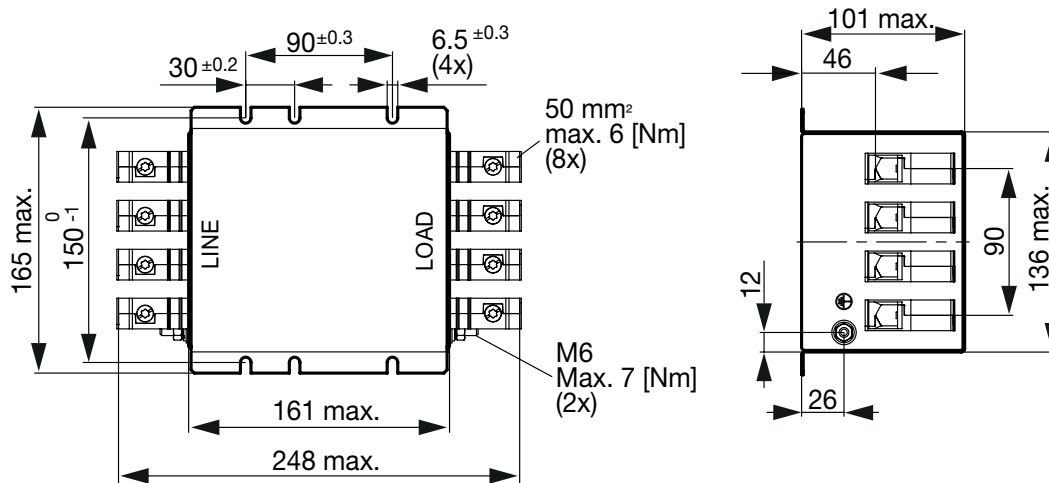

Case 5D-95

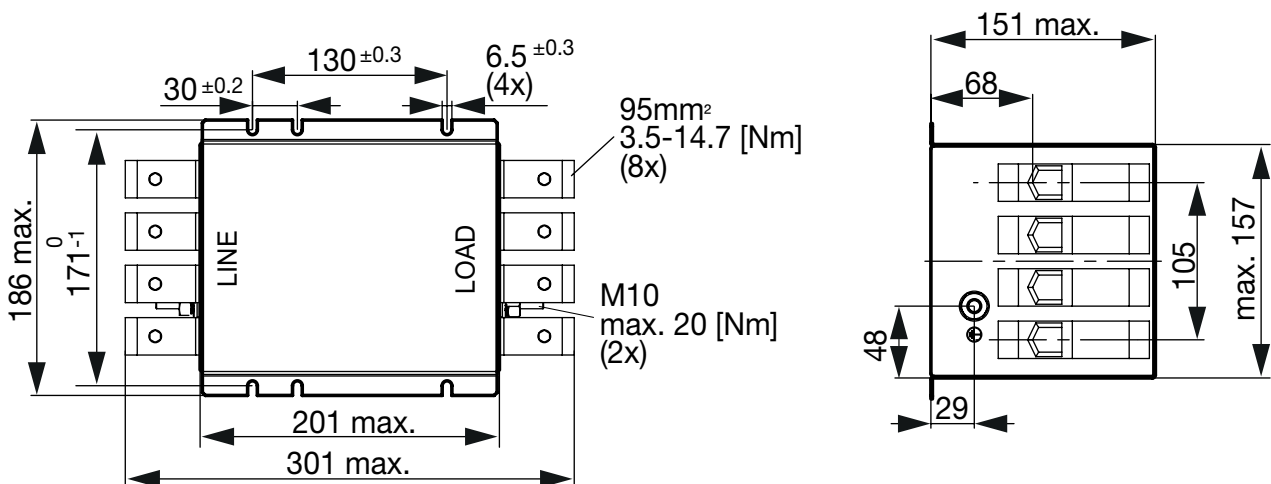

Diagrams

Low leakage current version

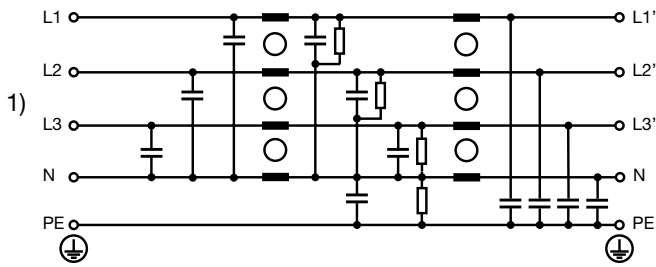

1) Line

**Attenuation Loss** . . . . 0.1/100Ω differential mode ..... 100/0.1Ω differential mode - - - 50Ω differential mode \_\_\_\_ 50Ω common mode  
 Industrial version

16 A / 520 V

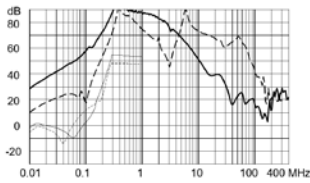

25 A / 520 V

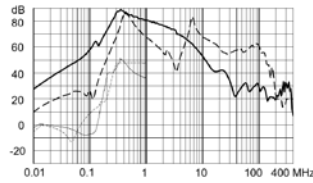

36 A / 520 V

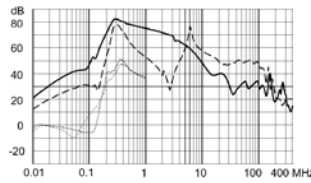

50 A / 520 V

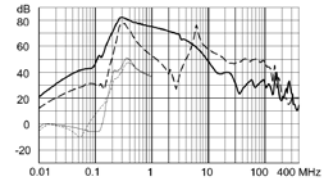

64 A / 520 V

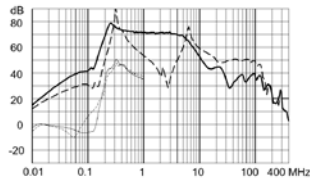

80 A / 520 V

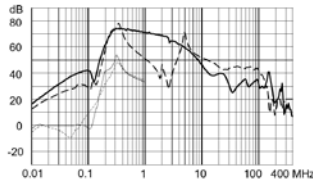

110 A / 520 V

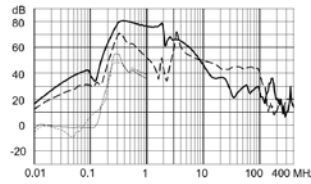

180 A / 520 V

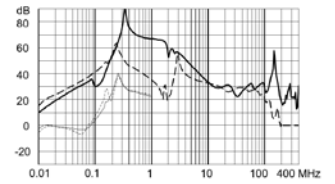

230 A / 520 V

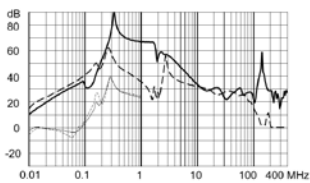

16 A / 760 V

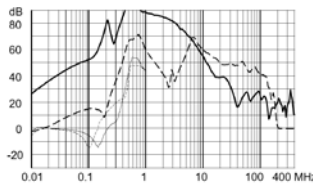

25 A / 760 V

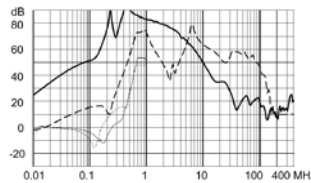

36 A / 760 V

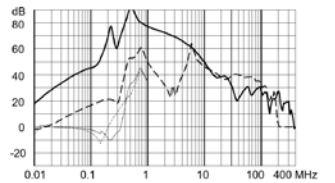

50 A / 760 V

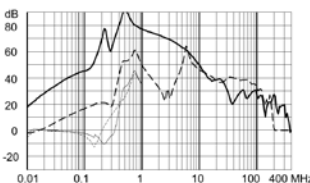

64 A / 760 V

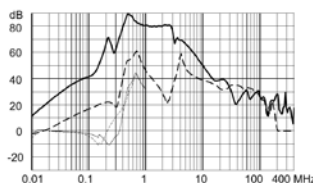

80 A / 760 V

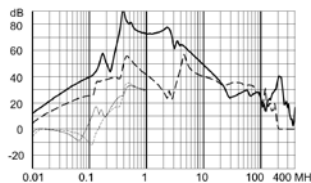

110 A / 760 V

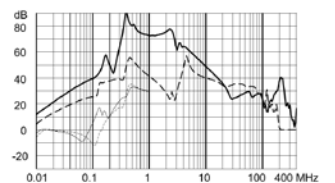

180 A / 760 V

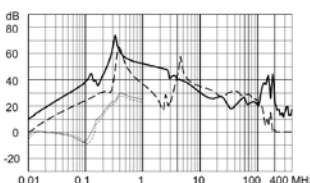

230 A / 760 V

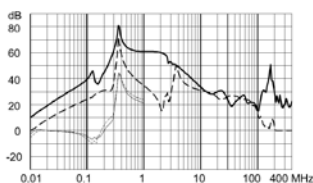

Low leakage current version

16 A / 520 V

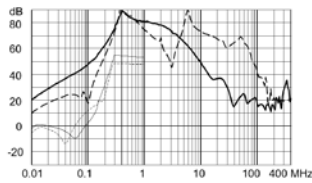

25 A / 520 V

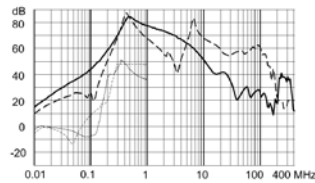

36 A / 520 V

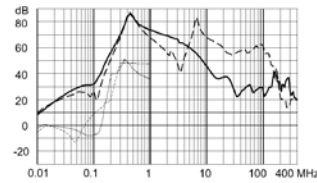

50 A / 520 V

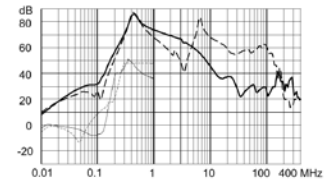

64 A / 520 V

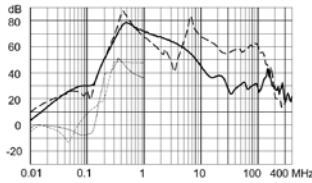

16 A / 760 V

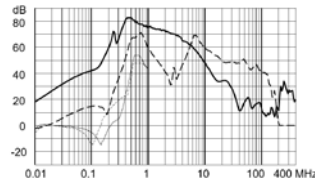

25 A / 760 V

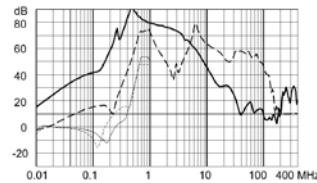

36 A / 760 V

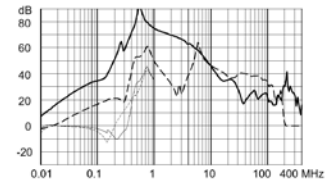

50 A / 760 V

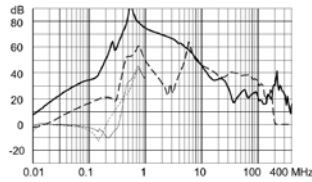

64 A / 760 V

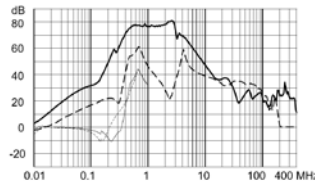

All Variants

| Rated Current @ Ta 50°C [A] | Rated Voltage [VAC] | Filter Type                 | Tripped Power Dissipation [W] | Contact Resistance [mΩ] | Leakage Current [mA] @ 440V, 60Hz 1) | Weight [kg] | Screw clamps [mm <sup>2</sup> 2) | Housing | Order Number              |
|-----------------------------|---------------------|-----------------------------|-------------------------------|-------------------------|--------------------------------------|-------------|----------------------------------|---------|---------------------------|
| 16                          | 520                 | Industrial version          | 1.3                           | 4.9                     | 6.82                                 | 1 kg        | 4                                | 5A-4    | <a href="#">3-128-371</a> |
| 25                          | 520                 | Industrial version          | 1.6                           | 2.5                     | 9.42                                 | 1.1 kg      | 10                               | 5A-10   | <a href="#">3-128-412</a> |
| 36                          | 520                 | Industrial version          | 2.1                           | 1.6                     | 9.42                                 | 1.35 kg     | 10                               | 5B-10   | <a href="#">3-128-413</a> |
| 50                          | 520                 | Industrial version          | 4                             | 1.6                     | 9.42                                 | 1.35 kg     | 10                               | 5B-10   | <a href="#">3-128-414</a> |
| 64                          | 520                 | Industrial version          | 5                             | 1.2                     | 9.42                                 | 1.6 kg      | 16                               | 5B-16   | <a href="#">3-128-415</a> |
| 80                          | 520                 | Industrial version          | 7.7                           | 1.2                     | 9.42                                 | 2.5 kg      | 25                               | 5C-25   | <a href="#">3-128-416</a> |
| 110                         | 520                 | Industrial version          | 15.8                          | 1.3                     | 9.42                                 | 3.3 kg      | 50                               | 5C-50   | <a href="#">3-128-417</a> |
| 180                         | 520                 | Industrial version          | 13                            | 0.4                     | 8.97                                 | 4.8 kg      | 95                               | 5D      | <a href="#">3-128-418</a> |
| 230                         | 520                 | Industrial version          | 10.6                          | 0.2                     | 8.97                                 | 5.9 kg      | 95                               | 5D      | <a href="#">3-128-419</a> |
| 16                          | 520                 | Low leakage current version | 1.3                           | 4.9                     | 2.55                                 | 1 kg        | 4                                | 5A-4    | <a href="#">3-128-420</a> |
| 25                          | 520                 | Low leakage current version | 1.6                           | 2.5                     | 2.55                                 | 1.1 kg      | 10                               | 5A-10   | <a href="#">3-128-421</a> |
| 36                          | 520                 | Low leakage current version | 2.1                           | 1.6                     | 2.56                                 | 1.35 kg     | 10                               | 5B-10   | <a href="#">3-128-422</a> |
| 50                          | 520                 | Low leakage current version | 4                             | 1.6                     | 2.56                                 | 1.35 kg     | 10                               | 5B-10   | <a href="#">3-128-423</a> |
| 64                          | 520                 | Low leakage current version | 5                             | 1.2                     | 2.56                                 | 1.6 kg      | 16                               | 5B-16   | <a href="#">3-128-424</a> |
| 16                          | 760                 | Industrial version          | 1.3                           | 4.9                     | 6.37                                 | 1 kg        | 4                                | 5A-4    | <a href="#">3-128-425</a> |
| 25                          | 760                 | Industrial version          | 1.6                           | 2.5                     | 6.37                                 | 1.1 kg      | 10                               | 5A-10   | <a href="#">3-128-426</a> |
| 36                          | 760                 | Industrial version          | 2.1                           | 1.6                     | 6.37                                 | 1.35 kg     | 10                               | 5B-10   | <a href="#">3-128-427</a> |
| 50                          | 760                 | Industrial version          | 4                             | 1.6                     | 6.37                                 | 1.35 kg     | 10                               | 5B-10   | <a href="#">3-128-428</a> |
| 64                          | 760                 | Industrial version          | 5                             | 1.2                     | 6.37                                 | 1.6 kg      | 16                               | 5B-16   | <a href="#">3-128-429</a> |
| 80                          | 760                 | Industrial version          | 7.7                           | 1.2                     | 8.97                                 | 2.5 kg      | 25                               | 5C-25   | <a href="#">3-128-430</a> |

| Rated Current @<br>Ta 50°C [A] | Rated Voltage<br>[VAC] | Filter Type                    | Tripped Power<br>Dissipation [W] | Contact Resi-<br>stance [mΩ] | Leakage Cur-<br>rent [mA] @ 440V,<br>60Hz 1) | Weight<br>[kg] | Screw clamps<br>[mm <sup>2</sup> ] 2) | Housing | Order Number |
|--------------------------------|------------------------|--------------------------------|----------------------------------|------------------------------|--|----------------|---------------------------------------|---------|--------------|
| 110                            | 760                    | Industrial version             | 15.8                             | 1.3                          | 8.97   | 3.3 kg         | 50                                    | 5C-50   | 3-128-431    |
| 180                            | 760                    | Industrial version             | 13                               | 0.4                          | 8.97   | 4.8 kg         | 95                                    | 5D      | 3-128-432    |
| 230                            | 760                    | Industrial version             | 10.6                             | 0.2                          | 8.97   | 5.9 kg         | 95                                    | 5D      | 3-128-433    |
| 16                             | 760                    | Low leakage current<br>version | 1.3                              | 4.9                          | 2.11   | 1 kg           | 4                                     | 5A-4    | 3-128-434    |
| 25                             | 760                    | Low leakage current<br>version | 1.6                              | 2.5                          | 2.11   | 1.1 kg         | 10                                    | 5A-10   | 3-128-435    |
| 36                             | 760                    | Low leakage current<br>version | 2.1                              | 1.6                          | 2.11   | 1.35 kg        | 10                                    | 5B-10   | 3-128-436    |
| 50                             | 760                    | Low leakage current<br>version | 4                                | 1.6                          | 2.11   | 1.35 kg        | 10                                    | 5B-10   | 3-128-437    |
| 64                             | 760                    | Low leakage current<br>version | 5                                | 1.2                          | 2.11   | 1.6 kg         | 16                                    | 5B-16   | 3-128-438    |

Availability for all products can be searched real-time: <https://www.schurter.com/en/Stock-Check/Stock-Check-SCHURTER>

1) Leakage current according IEC 60939-1

2) Maximum conductor cross section (wire gauge) to be used; a comparative table for AWG and mm<sup>2</sup> values can be found in the general product information <https://www.schurter.com/en/FAQ#10>

**Packaging unit** 1 Pcs