

AC Filter 2-Stage, excellent Attenuation

new



Case ME

Case MB

Case MF

See below:  
[Approvals and Compliances](#)

### Description

- Line filter in standard and medical version
- 2 stage
- Compact design
- Very light due to partial potting

### Unique Selling Proposition

- Excellent differential and common-mode attenuation
- Broad band attenuation
- Completely closed steel housing
- Wide temperature range

### Characteristics

- Designed for current applications of 1 - 36 A
- Protection against interference voltage from the mains  
Possible interferences generated in the equipment are strongly attenuated
- Especially designed for industrial applications such as: Frequency Converters, Stepper Motor Drives, UPS-Systems, Inverters
- Suitable for use in equipment according to IEC/UL 62368-1
- Suitable for use in medical equipment according to IEC/UL 60601-1

### References

Alternative: High attenuation version [FMBB NEO](#)

### Weblinks

[pdf data sheet](#), [html datasheet](#), [General Product Information](#), [Approvals](#), [Distributor-Stock-Check](#), [Detailed request for product](#), [Microsite](#)

### Technical Data

Ratings IEC	1 - 36A @ Ta 40 °C / 250 VAC; 50Hz
Ratings UL/CSA	1 - 36A @ Ta 40 °C / 125/250VAC; 60Hz
Leakage Current	standard < 0.5 mA (250 V / 60Hz) medical (M5) < 5 µA resp. (M80) < 80 µA (250 V / 60 Hz)
Dielectric Strength	1.7 kVDC between L-N 2.7 kVDC between L/N-PE Test voltage (2 sec)
Allowable Operation Temperature	-40 °C to 100 °C
Climatic Category	40/100/21 acc. to IEC 60068-1
IP-Protection	from rear-side IP20 IEC 60529
Protection Class	Suitable for appliances with protection class I acc. to IEC 61140
Terminal	Quick connect terminal 6.3 x 0.8 mm Bolt and nut M4
Material: Housing	Nickel plated steel

Line Filter	Standard and Medical Version, IEC 60939, UL 60939-3, CSA C22.2 no. 8 <a href="#">Technical Details</a>
MTBF	> 200'000h acc. to MIL-HB-217 F

### Approvals and Compliances



Detailed information on product approvals, code requirements, usage instructions and detailed test conditions can be looked up in [Details about Approvals](#)

SCHURTER products are designed for use in industrial environments. They have approvals from independent testing bodies according to national and international standards. Products with specific characteristics and requirements such as required in the automotive sector according to IATF 16949, medical technology according to ISO 13485 or in the aerospace industry can be offered exclusively with customer-specific, individual agreements by SCHURTER.

**Approvals**





The approval mark is used by the testing authorities to certify compliance with the safety requirements placed on electronic products.

Approval Reference Type: FMBB EP

Approval Logo	Certificates	Certification Body	Description
	<a href="#">VDE Approvals</a>	VDE	Certificate Number: 40051449
	<a href="#">UL Approvals</a>	UL	UL File Number: E495089



**Product standards**

Product standards that are referenced

Organization	Design	Standard	Description
	Designed according to	IEC 60939	Passive filters for suppressing electromagnetic interference
	Designed according to	IEC 60127-6	Miniature fuses. Part 6. Fuse-holders for miniature fuse-links
	Designed according to	UL 60939-3	Electromagnetic interference filters
	Designed according to	CSA C22.2 no. 42	General Use Receptacles, Attachment Plugs, and Similar Wiring Devices
	Designed according to	CSA C22.2 no. 8	Electromagnetic interference (EMI) filters





**Application standards**

Application standards where the product can be used

Organization	Design	Standard	Description
	Designed for applications acc.	IEC/UL 62368-1	IEC 62368-1 includes the basic requirements for safety of audio, video, information technology and office equipment.
	Designed for applications acc.	IEC 60601-1	Medical electrical equipment - Part 1: General requirements for basic safety and essential performance

**Compliances**

The product complies with following Guide Lines

Identification	Details	Initiator	Description
	<a href="#">CE declaration of conformity</a>	SCHURTER AG	The CE marking declares that the product complies with the applicable requirements laid down in the harmonisation of Community legislation on its affixing in accordance with EU Regulation 765/2008.
	<a href="#">RoHS</a>	SCHURTER AG	Directive RoHS 2011/65/EU, Amendment (EU) 2015/863
	<a href="#">China RoHS</a>	SCHURTER AG	The law SJ / T 11363-2006 (China RoHS) has been in force since 1 March 2007. It is similar to the EU directive RoHS.
	<a href="#">REACH</a>	SCHURTER AG	On 1 June 2007, Regulation (EC) No 1907/2006 on the Registration, Evaluation, Authorization and Restriction of Chemicals 1 (abbreviated as "REACH") entered into force.
	<a href="#">Medical Equipment</a>	SCHURTER AG	Suitable for use in medical equipment according to IEC/UL 60601-1

**Dimension [mm]**

Case 09 with quick connect terminals

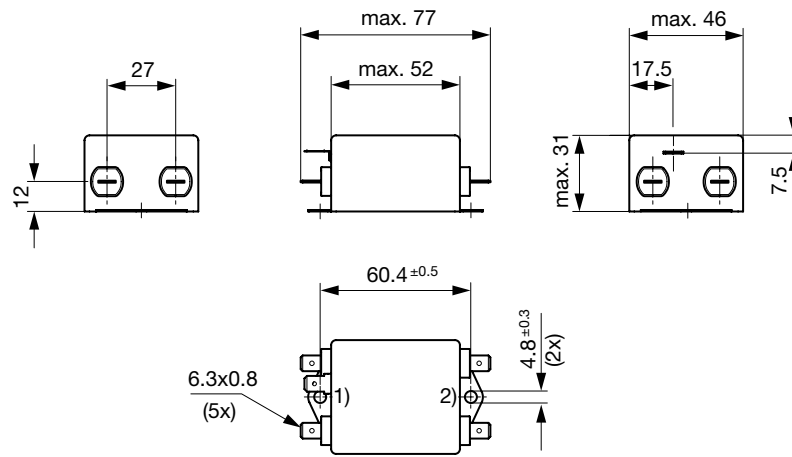

- 1) Line
- 2) Load

Case MB with bolt and nut M4

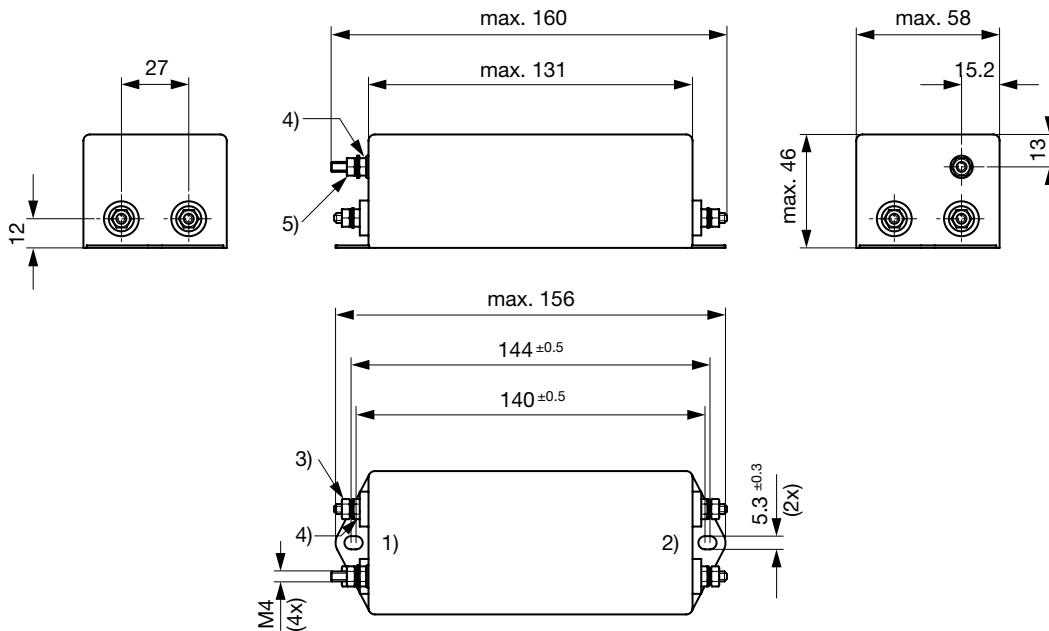

- 1) Line
- 2) Load
- 3) Nut torque 0.8...1 Nm, keep lock-nut fastened
- 4) Lock-nut do not unscrew
- 5) PE: M4x16, 1.2...1.5 Nm, keep lock-nut fastened

Case MC with quick connect terminals

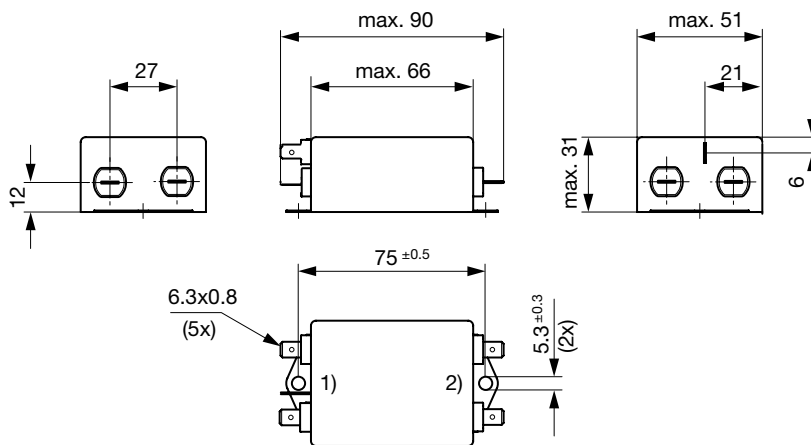

- 1) Line
- 2) Load

Case MD with quick connect terminals

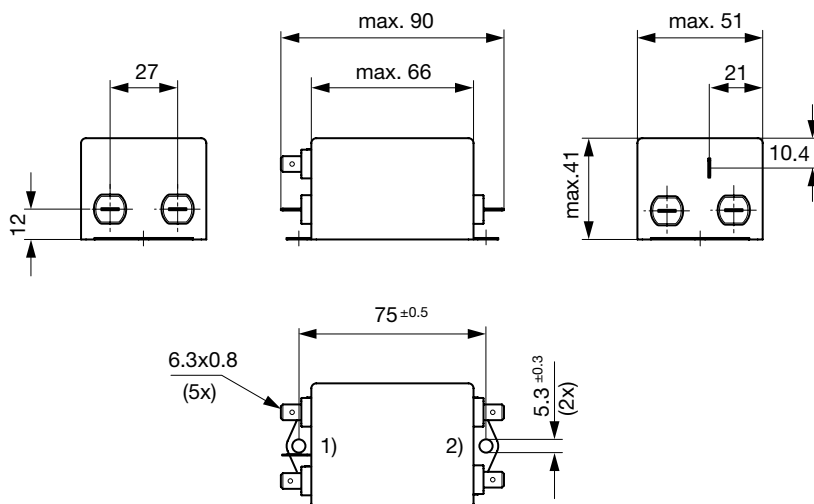

- 1) Line
- 2) Load

Case ME with quick connect terminals

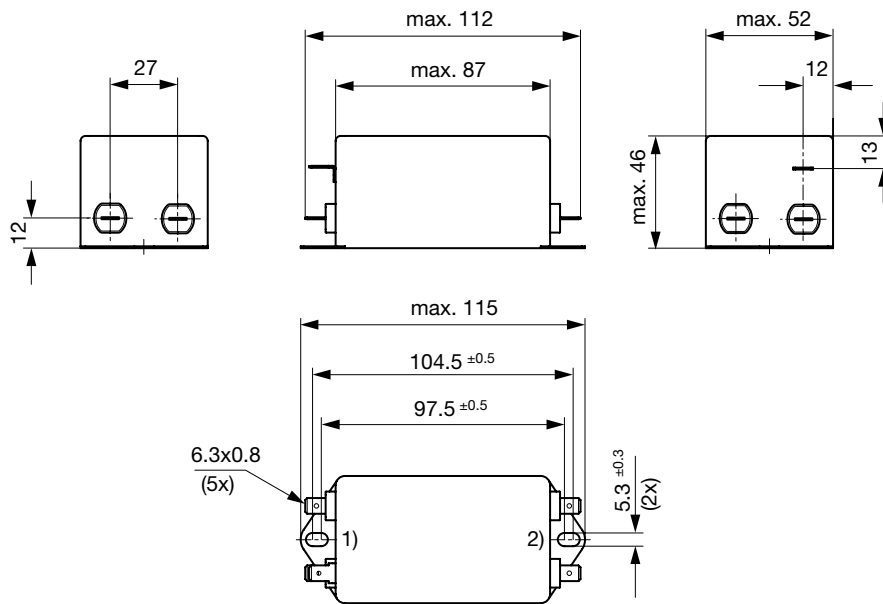

- 1) Line
- 2) Load

Case MF with bolt and nut M4

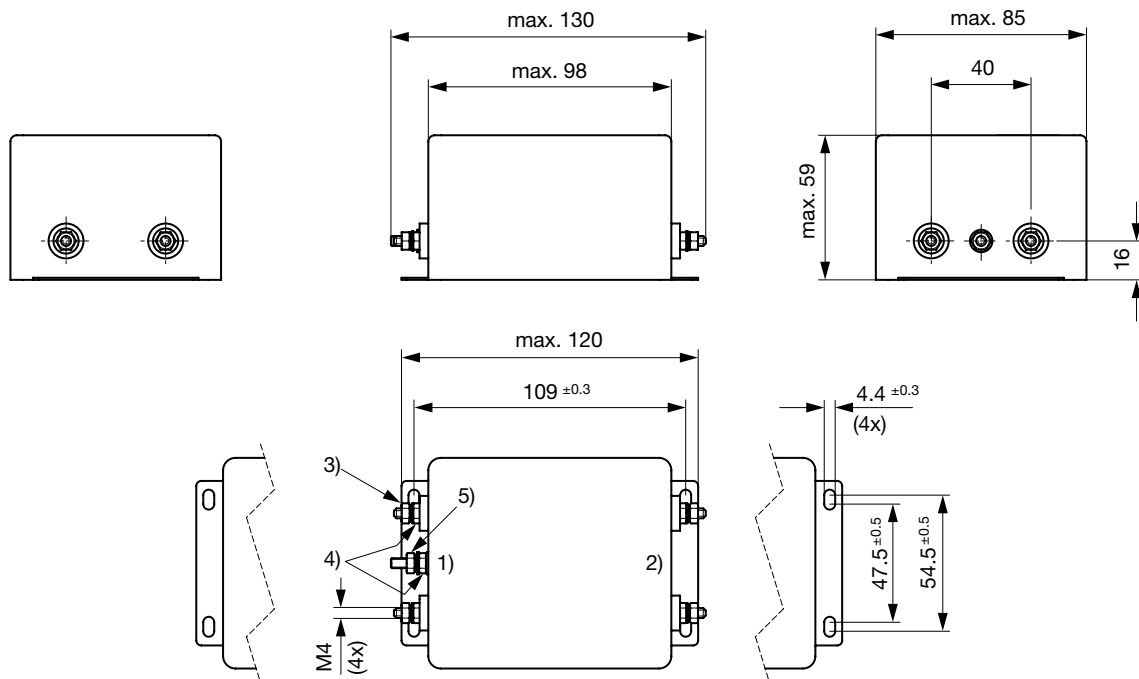

- 1) Line
- 2) Load
- 3) Nut torque 0.8...1 Nm, keep lock-nut fastened
- 4) Lock-nut do not unscrew
- 5) PE: M4x16, 1.2...1.5 Nm, keep lock-nut fastened

Diagrams

Standard and medical M80

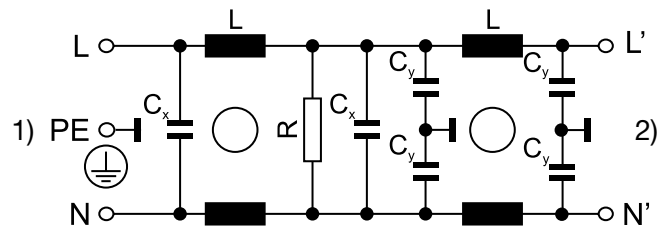

1) Line, 2) Load

Medical M5

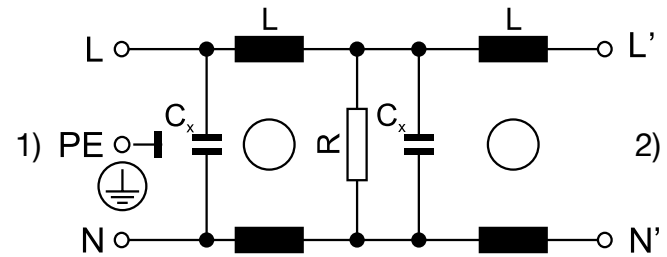

Attenuation Loss . . . . 0.1/100Ω differential mode ..... 100/0.1Ω differential mode - - - - 50Ω differential mode \_\_\_\_ 50Ω common mode  
 Standard version

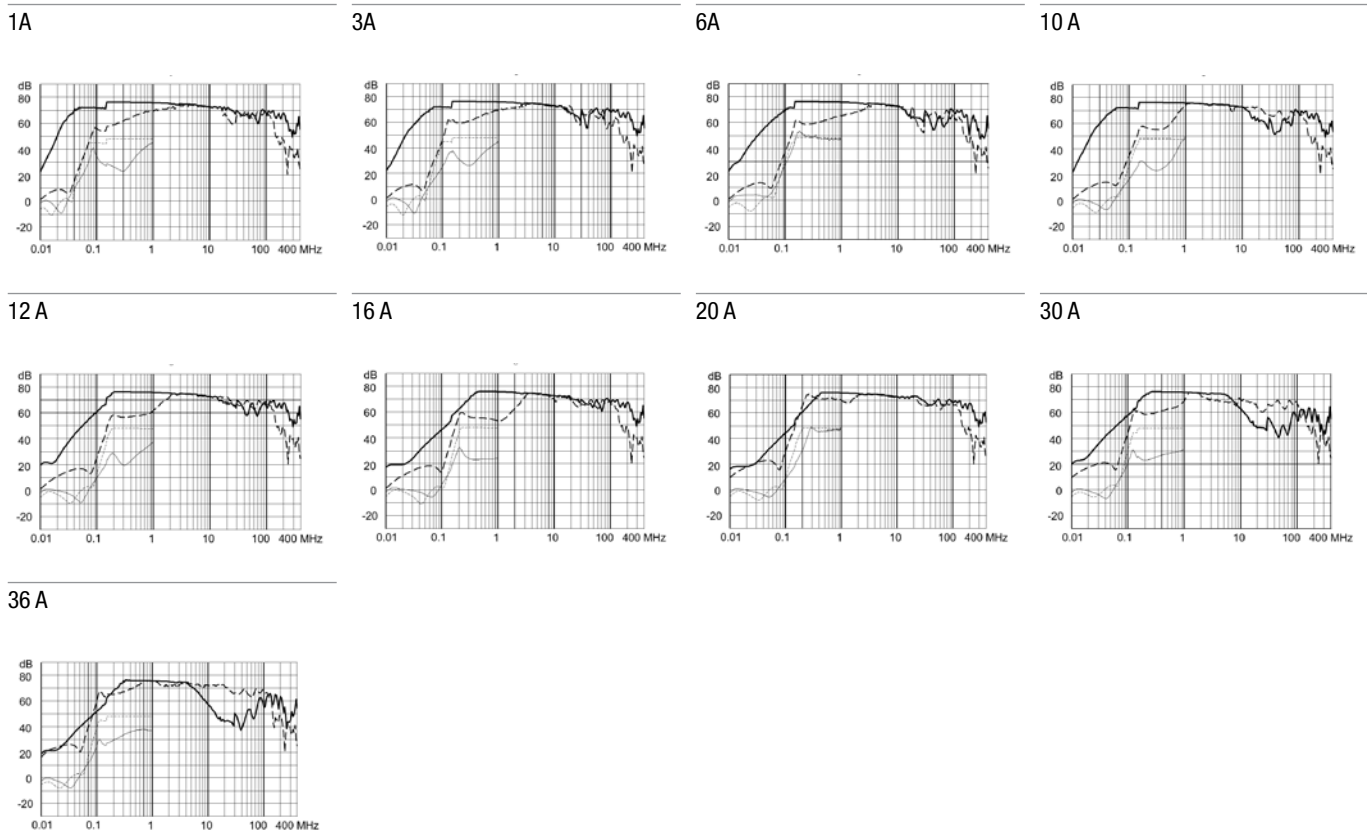



All Variants

Rated current	Filter-Type	Terminal	Leakage	Ri	Power Loss	Weight	Housings	Packaging	Order Number	
[A]			[mA]	[mΩ]	[W]	[g]		[ST]		
1	Standard version	Quick connect terminal 6.3 x 0.8 mm	0.86	600	1.2	125 g	09	15	3-123-509	■
3	Standard version	Quick connect terminal 6.3 x 0.8 mm	0.86	168	3	128 g	09	15	3-123-510	■
6	Standard version	Quick connect terminal 6.3 x 0.8 mm	0.86	40	2.88	133 g	09	15	3-123-511	■
10	Standard version	Quick connect terminal 6.3 x 0.8 mm	3.84	8.6	4.4	198 g	MC	10	3-123-522	■
12	Standard version	Quick connect terminal 6.3 x 0.8 mm	1.82	6.2	4.15	201 g	MC	10	3-123-523	■
16	Standard version	Quick connect terminal 6.3 x 0.8 mm	1.82	8.0	4.1	265 g	MD	10	3-123-524	■
20	Standard version	Quick connect terminal 6.3 x 0.8 mm	1.82	6	4.8	390 g	ME	5	3-123-525	■
30	Standard version	Bolt and nut M4	1.82	6	10.8	855 g	MF	3	3-123-526	■
36	Standard version	Bolt and nut M4	1.82	4.2	10.4	890 g	MB	4	3-123-527	■
1	Medical Version (M5)	Quick connect terminal 6.3 x 0.8 mm	0.005	600	1.2	125 g	09	15	3-123-528	
3	Medical Version (M5)	Quick connect terminal 6.3 x 0.8 mm	0.005	168	3	128 g	09	15	3-123-529	
6	Medical Version (M5)	Quick connect terminal 6.3 x 0.8 mm	0.005	40	2.88	133 g	09	15	3-123-530	
10	Medical Version (M5)	Quick connect terminal 6.3 x 0.8 mm	0.005	8.6	4.4	198 g	MC	10	3-123-531	
12	Medical Version (M5)	Quick connect terminal 6.3 x 0.8 mm	0.005	6.2	4.15	201 g	MC	10	3-123-532	
16	Medical Version (M5)	Quick connect terminal 6.3 x 0.8 mm	0.005	8.0	4.1	265 g	MD	10	3-123-533	
20	Medical Version (M5)	Quick connect terminal 6.3 x 0.8 mm	0.005	6	4.8	390 g	ME	5	3-123-534	
30	Medical Version (M5)	Bolt and nut M4	0.005	6	10.8	855 g	MF	3	3-123-535	
36	Medical Version (M5)	Bolt and nut M4	0.005	4.2	10.4	890 g	MB	4	3-123-536	
1	Medical Version (M80)	Quick connect terminal 6.3 x 0.8 mm	0.09	600	1.2	125 g	09	15	3-123-537	
3	Medical Version (M80)	Quick connect terminal 6.3 x 0.8 mm	0.09	168	3	128 g	09	15	3-123-538	
6	Medical Version (M80)	Quick connect terminal 6.3 x 0.8 mm	0.09	40	2.88	133 g	09	15	3-123-539	
10	Medical Version (M80)	Quick connect terminal 6.3 x 0.8 mm	0.09	8.6	4.4	198 g	MC	10	3-123-540	
12	Medical Version (M80)	Quick connect terminal 6.3 x 0.8 mm	0.09	6.2	4.15	201 g	MC	10	3-123-541	
16	Medical Version (M80)	Quick connect terminal 6.3 x 0.8 mm	0.09	8.0	4.1	265 g	MD	10	3-123-542	
20	Medical Version (M80)	Quick connect terminal 6.3 x 0.8 mm	0.09	6	4.8	390 g	ME	5	3-123-543	
30	Medical Version (M80)	Bolt and nut M4	0.09	6	10.8	855 g	MF	3	3-123-544	
36	Medical Version (M80)	Bolt and nut M4	0.09	4.2	10.4	890 g	MB	4	3-123-545	

■ Most Popular.

Availability for all products can be searched real-time: <https://www.schurter.com/en/Stock-Check/Stock-Check-SCHURTER>

Leakage current according IEC 60939-1