

Note: All part numbers are RoHS Compliant.

Table of Contents—Interface Module Systems

| | |
|------------------------------------------|----------|
| Overview (Catalog Numbering Code) | 196 |
| Interface Modules | 197-204 |
| DIN 41612 Connector | 198 |
| Telco Connector | 199 |
| D-Sub Connector | 200 |
| Flat Cable Connector | 201 |
| DIP and ZIF Sockets | 202 |
| Card Edge Modules | 203, 204 |
| Sockets | |
| 8 Pin Octal Socket Assemblies | 205 |
| 11 Pin Socket Assemblies | 206 |
| 16 Pin Miniature Socket Assemblies | 207 |
| 14 Pin Miniature Socket Assemblies | 208 |
| 11 Pin Square Socket Assemblies | 209 |
| Individual Sockets | 210 |
| SNAPTRACK Channel | 211 |
| Accessories | 212 |

Note: All part numbers are RoHS Compliant.

Catalog Numbering Code



NOTE: Some catalog number combinations are not valid. Check appropriate catalog pages before ordering.

Note: All part numbers are RoHS Compliant.

Interface Modules

Product Facts

- n Catalog designs for many industry connectors:
 - n DIN 41612 Connector
 - n Telco Connector
 - n D-Sub Connector
 - n Flat Cable Connector (daisy chain possible)
 - n DIP & ZIF Sockets
 - n Card Edge Modules
- n Mounts on SNAPTRACK Channel which can be panel mounted or snapped to a DIN rail.
- n Terminal Block screws supplied in ready-to-wire position to save installation time.



These Modules convert industry specific connectors to field wiring and are designed to supply custom solutions.

Note: All part numbers are RoHS Compliant.

DIN 41612 Connector



Material & Finish

Connector:

Housing Material—Thermoplastic polyester.

Flammability—UL94V-0

Terminals—Copper alloy, selective gold over nickel

Terminal Block:

Housing Material—Thermoplastic polyester

Flammability—UL94V-0

Color—Black

Max. Operating Temperature—120°C [248°]

Terminals—Bright acid-tin over copper alloy

Screws—#3-48, steel zinc plated

Wire Range—12-22 AWG

Mounting—2TK2 and 2TK2D Series SNAPTRACK Channel



2M64DIN-C

2M64DIN



| Description | DIN Connector Mates With | Non RoHS Compliant | |
|-------------------------------------------------------|--------------------------|--------------------|----------------|
| | | Part Number | Catalog Number |
| 64 Position reverse male DIN (Type R), A and C filled | Type Q | 3-1437684-4 | 2M64DIN |
| 64 Position male DIN (Type C), A and C filled | Type B | 3-1437684-5 | 2M64DIN-C |

| Description | DIN Connector Mates With | RoHS Compliant | |
|-------------------------------------------------------|--------------------------|----------------|----------------|
| | | Part Number | Catalog Number |
| 64 Position reverse male DIN (Type R), A and C filled | Type Q | 1776645-1 | 2M64DINL |
| 64 Position male DIN (Type C), A and C filled | Type B | 1776646-1 | 2M64DIN-CL |

Telco Connector



Material & Finish

Connector:

Housing Material—Thermoplastic polyester

Flammability—UL94V-0

Terminals—Copper alloy, selective gold over nickel

Application Data—2M50TELS(P)
Complies with SCSI Connections

Terminal Block:

Housing Material—Thermoplastic polyester

Flammability—UL94V-0

Color—Black

Max. Operating Temperature—120°C [248°]

Terminals—Bright acid-tin over copper alloy

Screws—#3-48, steel zinc plated

Wire Range—12-22 AWG

Mounting—2TK2 and 2TK2D Series SNAPTRACK Channel

| No. of Positions | Dim. C | Non RoHS Compliant | | | |
|------------------|--------------|--------------------|----------------|-------------|----------------|
| | | Socket | | Plug | |
| | | Part Number | Catalog Number | Part Number | Catalog Number |
| 36 | 4.30 (109.2) | 2-1437684-1 | 2M36TELS | — | 2M36TELP |
| 50 | 5.70 (144.8) | 3-1437684-2 | 2M50TELS | 3-1437684-1 | 2M50TELP |

| No. of Positions | Dim. C | RoHS Compliant | | | |
|------------------|--------------|----------------|----------------|-------------|----------------|
| | | Socket | | Plug | |
| | | Part Number | Catalog Number | Part Number | Catalog Number |
| 36 | 4.30 (109.2) | 1776826-1 | 2M36TELSL | — | 2M36TELPL |
| 50 | 5.70 (144.8) | 1776604-1 | 2M50TELSL | 1776643-1 | 2M50TELPL |

D-Sub Connector



Material & Finish

Connector:

Housing Material—Thermoplastic polyester.

Flammability—UL94V-0

Terminals—Copper alloy, selective gold over nickel

Shell Material—Bright tin plated, female screw locks installed

Terminal Block:

Housing Material—Thermoplastic polyester

Flammability—UL94V-0

Color—Black

Max. Operating Temperature—120°C [248°]

Terminals—Bright acid-tin over copper alloy

Screws—#3-48, steel zinc plated

Wire Range—12-22 AWG

Mounting—2TK2 and 2TK2D Series SNAPTRACK Channel

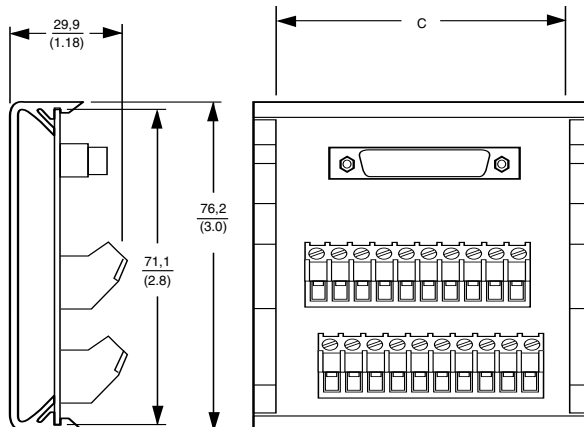

| No. of Positions | Dim. C | Non RoHS Compliant | |
|------------------|--------------|--------------------|----------------|
| | | Part Number | Catalog Number |
| 09 | 1.50 (38.1) | 1437684-3 | 2M09DSM |
| 15 | 2.10 (53.3) | 1437684-7 | 2M15DSM |
| 25 | 3.10 (78.7) | 1-1437684-8 | 2M25DSM |
| 37 | 4.31 (109.5) | 2-1437684-3 | 2M37DSM |
| 50 | 5.93 (150.6) | 2-1437684-9 | 2M50DSM |

Note: Female D-Sub connector available as 2MxxDSF. Consult Technical Support Center.

| No. of Positions | Dim. C | RoHS Compliant | |
|------------------|--------------|----------------|----------------|
| | | Part Number | Catalog Number |
| 09 | 1.50 (38.1) | 1546693-1 | 2M09DSML |
| 15 | 2.10 (53.3) | 1546694-1 | 2M15DSML |
| 25 | 3.10 (78.7) | 1776224-1 | 2M25DSML |
| 37 | 4.31 (109.5) | 1776612-1 | 2M37DSML |
| 50 | 5.93 (150.6) | 1776613-1 | 2M50DSML |

Note: Female D-Sub connector available as 2MxxDSFL. Consult Technical Support Center.

Flat Cable Connector

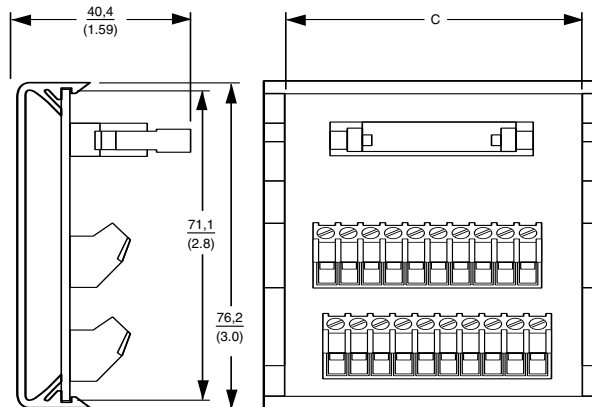

Material & Finish

Connector:

Header—Brass, gold over nickel, UL94V-0 thermoplastic

Connector—Copper alloy; gold over nickel 94V-0 thermoplastic

Wire Range—26-30 AWG solid, 28 AWG stranded

Maximum Current—1 Ampere

Terminal Block:

Housing Material—Thermoplastic polyester

Flammability—UL94V-0

Color—Black

Max. Operating Temperature—120°C [248°]

Terminals—Bright acid-tin over copper alloy

Screws—#3-48, steel zinc plated

Wire Range—12-22 AWG

Mounting—2TK2 and 2TK2D Series SNAPTRACK Channel

| No. of Positions | Dim. C | Non RoHS Compliant | | RoHS Compliant | |
|------------------|--------------|--------------------|----------------|----------------|----------------|
| | | Part Number | Catalog Number | Part Number | Catalog Number |
| 10 | 38.1 (1.50) | 1437684-5 | 2M10FC | 1776615-1 | 2M10FCL |
| 14 | 53.3 (2.10) | 1437684-6 | 2M14FC | 1776616-1 | 2M14FCL |
| 16 | 58.4 (2.30) | 1-1437684-1 | 2M16FC | 1776625-1 | 2M15FCL |
| 20 | 68.6 (2.70) | 1-1437684-2 | 2M20FC | 1776626-1 | 2M20FCL |
| 26 | 81.3 (3.20) | 1-1437684-9 | 2M26FC | 1776630-1 | 2M26FCL |
| 34 | 104.1 (4.10) | 2-1437684-0 | 2M34FC | 1776638-1 | 2M34FCL |
| 40 | 119.4 (4.70) | 2-1437684-6 | 2M40FC | 1776640-1 | 2M40FCL |
| 50 | 139.7 (5.50) | 3-1437684-0 | 2M50FC | 1776642-1 | 2M50FCL |
| 60 | 165.1 (6.50) | 3-1437684-3 | 2M60FC | 1776644-1 | 2M60FCL |
| 64 | 170.2 (6.70) | 3-1437684-6 | 2M64FC | 1776647-1 | 2M64FCL |

Note: Strain relief connector supplied with all assemblies.

Note: All part numbers are RoHS Compliant.

DIP and ZIF Sockets



Material & Finish

Connector:

Terminal—Contacts copper alloy, gold over nickel

Terminal Block:

Housing Material—Thermoplastic polyester

Flammability—UL94V-0

Color—Black

Max. Operating Temperature—120°C [248°]

Terminals—Bright acid-tin over copper alloy

Screws—#3-48, steel zinc plated

Wire Range—12-22 AWG

Mounting—2TK2 and 2TK2D Series SNAPTRACK Channel

2M16DP

2M16DPZ



| No. of Positions | Socket Pin Spacing Grid Size Dimensions | | | Non RoHS Compliant | |
|-------------------------------------|-----------------------------------------|--------------|-----------------------------|--------------------|----------------|
| | B | C | D | Part Number | Catalog Number |
| DIP Socket to Screw Terminal | | | | | |
| 8 | 1.05 (26.7) | 1.20 (30.5) | .100 x .300 (2.5 x 7.6) | 1437684-2 | 2M08DP |
| 16 | 1.05 (26.7) | 2.00 (50.8) | .100 x .300 (2.5 x 7.6) | 1437684-8 | 2M16DP |
| 24 | 1.05 (26.7) | 2.80 (71.1) | .100 x .600 (2.5 x 15.2) | 1-1437684-4 | 2M24DP |
| 40 | 1.05 (26.7) | 4.40 (111.8) | .100 x .600 (2.5 x 15.2) | 2-1437684-4 | 2M40DP |
| ZIF Socket to Screw Terminal | | | | | |
| 16 | 1.40 (35.6) | 2.00 (50.8) | — | 1-1437684-0 | 2M16DPZ |
| 24 | 1.40 (35.6) | 2.80 (71.1) | — | 1-1437684-5 | 2M24DPZ |
| 40 | 1.40 (35.6) | 4.40 (111.8) | — | 2-1437684-5 | 2M40DPZ |

Note: ZIF denotes zero insertion force.

| No. of Positions | Socket Pin Spacing Grid Size Dimensions | | | RoHS Compliant | |
|-------------------------------------|-----------------------------------------|--------------|-----------------------------|----------------|----------------|
| | B | C | D | Part Number | Catalog Number |
| DIP Socket to Screw Terminal | | | | | |
| 8 | 1.05 (26.7) | 1.20 (30.5) | .100 x .300 (2.5 x 7.6) | 1776599-1 | 2M08DPL |
| 16 | 1.05 (26.7) | 2.00 (50.8) | .100 x .300 (2.5 x 7.6) | 1776600-1 | 2M16DPL |
| 24 | 1.05 (26.7) | 2.80 (71.1) | .100 x .600 (2.5 x 15.2) | 1776602-1 | 2M24DPL |
| 40 | 1.05 (26.7) | 4.40 (111.8) | .100 x .600 (2.5 x 15.2) | 1776603-1 | 2M40DPL |
| ZIF Socket to Screw Terminal | | | | | |
| 16 | 1.40 (35.6) | 2.00 (50.8) | — | 1776624-1 | 2M16DPZL |
| 24 | 1.40 (35.6) | 2.80 (71.1) | — | 1776628-1 | 2M24DPZL |
| 40 | 1.40 (35.6) | 4.40 (111.8) | — | 1776639-1 | 2M40DPZL |

Note: ZIF denotes zero insertion force.

Card Edge Modules



Material & Finish

Connector—Gold over nickel contact with card guide—accepts up to 4.5" [114.30] wide board. 0.156" [3.96] pitch (terminal spacing)

22PCB, 44PC

Terminal Block Tri-Barrier

Terminals—Bright acid tin over copper alloy

Screws—#4-40 steel zinc with clear chromate with captive wire clamping plate

Wire Range—14-22 AWG

Mounting—Fits TK2 & TK2D Series

2M22PCB, 2M44PC

Terminal Block:

Housing Material—Thermoplastic polyester

Flammability—UL94V-0

Color—Black

Max. Operating Temperature—120°C [248°]

Terminals—Bright acid-tin over copper alloy

Screws—#3-48, steel zinc plated

Wire Range—12-22 AWG

Mounting—2TK2 and 2TK2D Series SNAPTRACK Channel

| Description | Non RoHS Compliant | |
|------------------------------------------------------------------------|--------------------|----------------|
| | Part Number | Catalog Number |
| For single-sided notched cards. Numbered Terminals 1-22 and A-Z | 1437684-1 | 22PCB |
| For double-sided, notched cards. Numbered terminals A-Z, 1-22 and 1-44 | 3-1437684-7 | 44PC |
| Similar to 22PCB but all terminal positions are on one side of board | 1-1437684-3 | 2M22PCB |
| Similar to 44PC but all terminal positions are on one side of board | 2-1437684-7 | 2M44PC |

| Description | RoHS Compliant | |
|------------------------------------------------------------------------|----------------|----------------|
| | Part Number | Catalog Number |
| For single-sided notched cards. Numbered Terminals 1-22 and A-Z | 1776614-1 | 22PCBL |
| For double-sided, notched cards. Numbered terminals A-Z, 1-22 and 1-44 | 1776649-1 | 44PCL |
| Similar to 22PCBL but all terminal positions are on one side of board | 1776627-1 | 2M22PCBL |
| Similar to 44PCL but all terminal positions are on one side of board | 1776641-1 | 2M44PCL |

Note: All part numbers are RoHS Compliant.

Card Edge Modules (Continued)

2M22PCB and 2M44PC



22PCB and 44PC

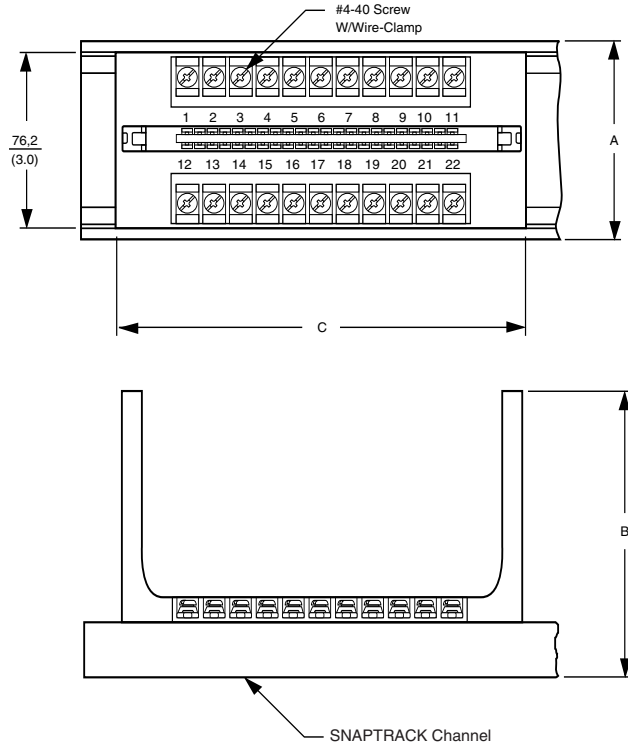

| No. of Positions | Track Size | Dimensions | | | | Non RoHS Compliant | |
|------------------|------------|-------------|-------------|--------------|---------------|--------------------|----------------|
| | | A Ref. | B | C | PC Card Width | Part Number | Catalog Number |
| 22 | TK(2D) | 80.3 (3.16) | 90.4 (3.56) | 127.0 (5.00) | 114.3 (4.5) | 1437684-1 | 22PCB |
| | 2TK(2D) | 69.9 (2.75) | 90.4 (3.56) | 127.0 (5.00) | 114.3 (4.5) | 1-1437684-3 | 2M22PCB |
| 44 | TK (2D) | 80.3 (3.16) | 90.4 (3.56) | 190.5 (7.50) | 114.3 (4.5) | 3-1437684-7 | 44PC |
| | 2TK(2D) | 69.9 (2.75) | 90.4 (3.56) | 127.0 (5.00) | 114.3 (4.5) | 2-1437684-7 | 2M44PC |

| No. of Positions | Track Size | Dimensions | | | | RoHS Compliant | |
|------------------|------------|-------------|-------------|--------------|---------------|----------------|----------------|
| | | A Ref. | B | C | PC Card Width | Part Number | Catalog Number |
| 22 | TK(2D) | 80.3 (3.16) | 90.4 (3.56) | 127.0 (5.00) | 114.3 (4.5) | 1776614-1 | 22PCBL |
| | 2TK(2D) | 69.9 (2.75) | 90.4 (3.56) | 127.0 (5.00) | 114.3 (4.5) | 1776627-1 | 2M22PCBL |
| 44 | TK (2D) | 80.3 (3.16) | 90.4 (3.56) | 190.5 (7.50) | 114.3 (4.5) | 1776649-1 | 44PCL |
| | 2TK(2D) | 69.9 (2.75) | 90.4 (3.56) | 127.0 (5.00) | 114.3 (4.5) | 1776641-1 | 2M44PCL |

Note: All part numbers are RoHS Compliant.

8 Pin Octal Socket Assemblies

SM8 and 608BR



318BR, 208BR, 608BR, 218BR



Material & Finish

208BR, 218BR, 318BR

Rating—10A, 150V

Screws—#4-40 zinc plated with clear chromate, with wire clamp

Wire Range—4-22 AWG

Bails—RB1, TB1(see accessory page 212)

608BR

Rating—10A, 250V

Screws—#6-32 zinc plated with wire clamp

Wire Range—12-22 AWG

Bails—RB1, TB1(see accessory page 212)

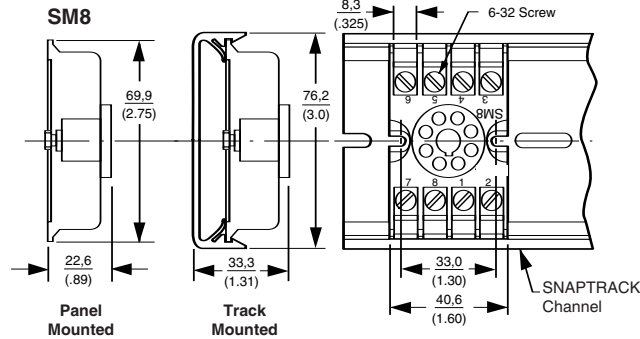

SM8

Rating—10A, 300V

Material—ABS

Flammability—UL94V-0

Contacts—Tin over copper-plated phosphor-bronze.

Screws—#6-32 zinc plated with clear chromate with wire clamping plates

Wire Range—12-22 AWG

Max. Operating Temperature—60°C [140°F]

| Dimensions | | | | Non RoHS Compliant | | RoHS Compliant |
|-------------|-------------|-------------|-------------|--------------------|----------------|--------------------|
| A | B | C | D | Part Number | Catalog Number | SNAPTRACK® Channel |
| 3.16 (80.3) | 1.13 (28.7) | 2.00 (50.8) | 1.69 (42.9) | 1437683-6 | 208BR | TK2(D) |
| 3.16 (80.3) | 1.13 (28.7) | 1.50 (38.1) | — | 1-1437683-0 | 218BR | TK2(D) |
| 2.90 (73.7) | 1.13 (28.7) | 1.50 (38.1) | — | 1-1437683-4 | 318BR | 2TK2(D) |
| 3.16 (80.3) | 1.13 (28.7) | 2.00 (50.8) | 1.69 (42.9) | 1-1437683-6 | 608BR | TK2(D) |
| — | — | — | — | 2-1437683-8 | SM8 | 2TK2 |

Note: SM8 is a molded product with mounting holes provided.

Related Product Data

Sockets on this page will fit the following relays:

Tyco Electronics Relay Series—SCB, SCC, SCE, SRC, SSC, SST, VMA

P&B Relay Series—CB, CD, CG, CH, CK, CR, CN1, CNS, CS, KRP/KRPA, S89R_P, 155

SCHRACK Relay Series—MT

For more information on Relays request Catalog 1308242.

| Dimensions | | | | RoHS Compliant | | |
|-------------|-------------|-------------|-------------|----------------|----------------|--------------------|
| A | B | C | D | Part Number | Catalog Number | SNAPTRACK® Channel |
| 3.16 (80.3) | 1.13 (28.7) | 2.00 (50.8) | 1.69 (42.9) | 1776633-1 | 208BRL | TK2(D) |
| 3.16 (80.3) | 1.13 (28.7) | 1.50 (38.1) | — | 1776617-1 | 218BRL | TK2(D) |
| 2.90 (73.7) | 1.13 (28.7) | 1.50 (38.1) | — | 1776619-1 | 318BRL | 2TK2(D) |
| 3.16 (80.3) | 1.13 (28.7) | 2.00 (50.8) | 1.69 (42.9) | 1776620-1 | 608BRL | TK2(D) |
| — | — | — | — | 2-1437683-8 | SM8 | 2TK2 |

Note: SM8 is a molded product with mounting holes provided.

Note: All part numbers are RoHS Compliant.

11 Pin Socket Assemblies

SM11 and 611BR



Material & Finish

211BR, 311BR

Rating—10A, 150V
Screws—#4-40 zinc plated with clear chromate with wire clamps
Wire Range—14-22 AWG
Bails—RB1, TB1 (see accessory page 212)

611BR

Rating—10A, 250V
Screws—#6-32 zinc plated with clear chromate, with wire clamps.
Wire Range—12-22 AWG
Bails—RB1, TB1 (see accessory page 212)



SM11

Rating—10A, 300V
Material—ABS
Flammability—UL94V-0
Max. Operating Temperature—60°C [140°F]
Contacts—Tin over copper-plated phosphor-bronze.
Screws—#6-32 zinc plated with clear chromate, with wire clamps
Wire Range—12-22 AWG
Bails—RB5 (see accessory page 212)

| Dimensions | | | | Non RoHS Compliant | | RoHS Compliant |
|-------------|-------------|-------------|-------------|--------------------|----------------|--------------------|
| A | B | C | D | Part Number | Catalog Number | SNAPTRACK® Channel |
| 3.16 (80.3) | 1.13 (28.7) | 2.13 (54.1) | 1.18 (46.0) | 1437683-7 | 211BR | TK2(D) |
| 2.90 (73.7) | 1.13 (28.7) | 2.13 (54.1) | 1.18 (46.0) | 1-1437683-2 | 311BR | 2TK2(D) |
| 3.16 (80.3) | 1.13 (28.7) | 2.75 (69.9) | 2.30 (60.5) | 1-1437683-8 | 611BR | TK2(D) |
| — | — | — | — | 2-1437683-7 | SM11 | 2TK |

Note: SM11 is a molded product with mounting holes provided.

Related Product Data

Sockets on this page will fit the following relays:

- Tyco Electronics Relay Series**—SCF, SSC, SCB, SCC, SST
- P&B Relay Series**—CB, CD, CG, CH, CK, CNM5, CNS, CNT, KBP, KRP/KRPA, 155
- SCHRACK Relay Series**—MT

For more information on Relays request Catalog 1308242.

| Dimensions | | | | RoHS Compliant | | |
|-------------|-------------|-------------|-------------|----------------|----------------|--------------------|
| A | B | C | D | Part Number | Catalog Number | SNAPTRACK® Channel |
| 3.16 (80.3) | 1.13 (28.7) | 2.13 (54.1) | 1.18 (46.0) | 1776634-1 | 211BRL | TK2(D) |
| 2.90 (73.7) | 1.13 (28.7) | 2.13 (54.1) | 1.18 (46.0) | 1776827-1 | 311BRL | 2TK2(D) |
| 3.16 (80.3) | 1.13 (28.7) | 2.75 (69.9) | 2.30 (60.5) | 1776622-1 | 611BRL | TK2(D) |
| — | — | — | — | 2-1437683-7 | SM11 | 2TK |

Note: SM11 is a molded product with mounting holes provided.



Note: All part numbers are RoHS Compliant.

16 Pin Miniature Socket Assemblies

204BS

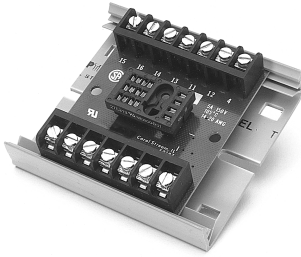

Material & Finish

- Rating**—5A,150V
- Max. Operating Temperature**—105°C
- Screws**—#4-40 zinc plated with captive wire clamping plate
- Wire Range**—14-22 AWG
- Bails**—204BS-RB4 (see accessory page 212)

Related Product Data

Sockets on this page will fit the following relays:

P&B Relay Series—R10

For more information on Relays request Catalog 1308242.

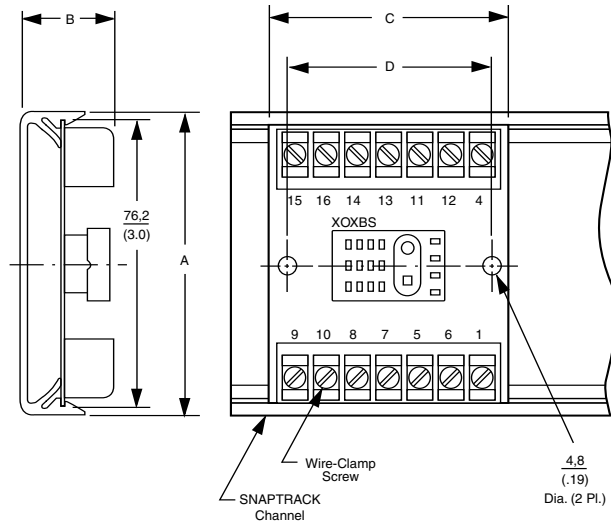

| Dimensions | | | | Fits Relay | Non RoHS Compliant | | RoHS Compliant |
|-------------|-------------|-------------|-------------|------------|--------------------|----------------|--------------------|
| A | B | C | D | | Part Number | Catalog Number | SNAPTRACK® Channel |
| 3.16 (80.3) | 1.00 (25.4) | 1.50 (38.1) | — | 2PDT | 1437683-4 | 202BS | TK2(D) |
| 3.16 (80.3) | 1.00 (25.4) | 2.50 (63.5) | 2.13 (54.1) | 4PDT | 1437683-5 | 204BS | TK2 |

Note: Holes provided for bails, see page 212.

| Dimensions | | | | Fits Relay | RoHS Compliant | | |
|-------------|-------------|-------------|-------------|------------|----------------|----------------|--------------------|
| A | B | C | D | | Part Number | Catalog Number | SNAPTRACK® Channel |
| 3.16 (80.3) | 1.00 (25.4) | 1.50 (38.1) | — | 2PDT | 1776631-1 | 202BSL | TK2(D) |
| 3.16 (80.3) | 1.00 (25.4) | 2.50 (63.5) | 2.13 (54.1) | 4PDT | 1776632-1 | 204BSL | TK2 |

Note: Holes provided for bails, see page 212.



Note: All part numbers are RoHS Compliant.

14 Pin Miniature Socket Assemblies

214BS

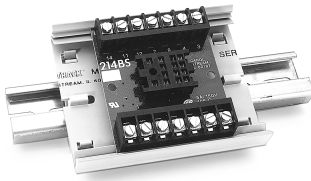

Material & Finish

Ratings—5A,150V

214BS, 314BS

Screws—#4-40 zinc plated with clear chromate, with captive wire clamping plate

Wire Range—14-22 AWG

614BS

Screws—#6-32 zinc plated with clear chromate, with wire clamp

Wire Range—12-22 AWG



Related Product Data

Sockets on this page will fit the following relays:

P&B Relay Series—KHAU/KHU, 156, 158

SCHRACK Relay Series—PT

For more information on Relays request Catalog 1308242.

| Dimensions | | | | Fits Relay | Non RoHS Compliant | | RoHS Compliant |
|-------------|-------------|-------------|-------------|------------|--------------------|----------------|--------------------|
| A | B | C | D | | Part Number | Catalog Number | SNAPTRACK® Channel |
| 3.16 (80.3) | 1.06 (26.9) | 2.50 (63.5) | 2.13 (54.0) | 4PDT | 1437683-9 | 214BS | TK2(D) |
| 2.90 (73.7) | 1.06 (26.9) | 2.50 (63.5) | — | 4PDT | 1-1437683-3 | 314BS | 2TK2(D) |
| 3.16 (80.3) | 1.13 (28.7) | 2.75 (69.9) | — | 4PDT | 2-1437683-0 | 614BS | TK2(D) |

Note: Holes provided for bails, see page 212.

| Dimensions | | | | Fits Relay | RoHS Compliant | | |
|-------------|-------------|-------------|-------------|------------|----------------|----------------|--------------------|
| A | B | C | D | | Part Number | Catalog Number | SNAPTRACK® Channel |
| 3.16 (80.3) | 1.06 (26.9) | 2.50 (63.5) | 2.13 (54.0) | 4PDT | 1776636-1 | 214BSL | TK2(D) |
| 2.90 (73.7) | 1.06 (26.9) | 2.50 (63.5) | — | 4PDT | 1776618-1 | 314BSL | 2TK2(D) |
| 3.16 (80.3) | 1.13 (28.7) | 2.75 (69.9) | — | 4PDT | 1776637-1 | 614BSL | TK2(D) |

Note: Holes provided for bails, see page 212.



Note: All part numbers are RoHS Compliant.

11 Pin Square Socket Assemblies

608BS

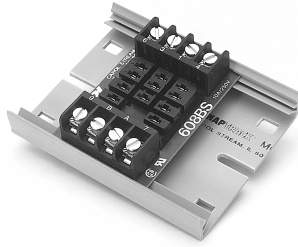

Material & Finish

608BS, 611BS

Rating—10A, 250V

Screws—#6-32 zinc plated with clear chromate, with wire clamp

Wire Range—12-22 AWG

211BS

Rating—10A, 150V

Screws—#4-40 zinc plated with clear chromate, with wire clamp

Wire Range—14-22 AWG

Related Product Data

Sockets on this page will fit the following relays:

Tyco Electronics Relay Series—STA

P&B Relay Series—CL, CU, KUPE, KUIP, KUMP, KUGP, KUL, KUP, SDAS-01, 157

SCHRACK Relay Series—RM2/3/7, RM5/6

For more information on Relays request Catalog 1308242.

| Dimensions | | | Fits Relay | Non RoHS Compliant | | RoHS Compliant |
|-------------|-------------|-------------|------------|--------------------|----------------|--------------------|
| A | B | C | | Part Number | Catalog Number | SNAPTRACK® Channel |
| 3.16 (80.3) | 1.06 (26.9) | 2.13 (54.1) | SPDT, DPDT | 1437683-8 | 211BS | TK2(D) |
| 3.16 (80.3) | 1.13 (28.7) | 2.00 (50.8) | 3PDT | 1-1437683-7 | 608BS | TK2(D) |
| 3.16 (80.3) | 1.13 (28.7) | 2.50 (63.5) | DPDT, 3PDT | 1-1437683-9 | 611BS | TK2(D) |

| Dimensions | | | Fits Relay | RoHS Compliant | | |
|-------------|-------------|-------------|------------|----------------|----------------|--------------------|
| A | B | C | | Part Number | Catalog Number | SNAPTRACK® Channel |
| 3.16 (80.3) | 1.06 (26.9) | 2.13 (54.1) | SPDT, DPDT | 1776630-1 | 211BSL | TK2(D) |
| 3.16 (80.3) | 1.13 (28.7) | 2.00 (50.8) | 3PDT | 1776621-1 | 608BSL | TK2(D) |
| 3.16 (80.3) | 1.13 (28.7) | 2.50 (63.5) | DPDT, 3PDT | 1776623-1 | 611BSL | TK2(D) |

Note: All part numbers are RoHS Compliant.

Individual Sockets

Material & Finish

- Ratings**—10A/300V
- Housing Material**—Thermoplastic polyester
- Flammability**—UL94V-0
- Color**—Black
- Max. Operating Temperature**—130°C [266°F]
- Contacts**—Phosphor-bronze, bright acid-tin plated

Related Product Data

Sockets 8S and 11S will fit the following relays:

- AGASTAT Relay Series**—STA
- P&B/MIDTEX Relay Series**—CL, CU, KUJP, KUIP, KUMP, KUGP, KUL, KUP, SDAS-01, 157
- SCHRACK Relay Series**—RM2/3/7, RM5/6
- Socket 21S will fit the following relays:
- P&B Relay Series**—R10
- Socket 14S will fit the following relays:
- P&B/MIDTEX Relay Series**—KHAU/KHU, 156, 158
- SCHRACK Relay Series**—PT

- Socket 8R will fit the following relays:
- AGASTAT Relay Series**—SCB, SCC, SCE, SRC, SSC, SST, VMA
- P&B/MIDTEX Relay Series**—CB, CD, CG, CH, CK, CR, CN1, CNS, CS, KRP/KRPA, S89R__P, 155
- SCHRACK Relay Series**—MT

Socket 11R will fit the following relays:

- Tyco Electronics Relay Series**—SCF, SSC, SCB, SCC, SST
- P&B Relay Series**—CB, CD, CG, CH, CK, CNM5, CNS, CNT, KBP, KRP/KRPA, 155
- SCHRACK Relay Series**—MT

For more information on Relays request Catalog 1308242.

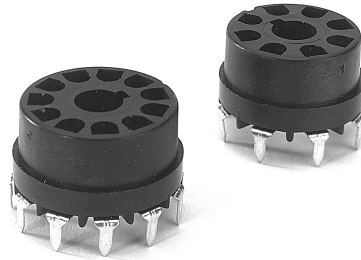

11R, 8R

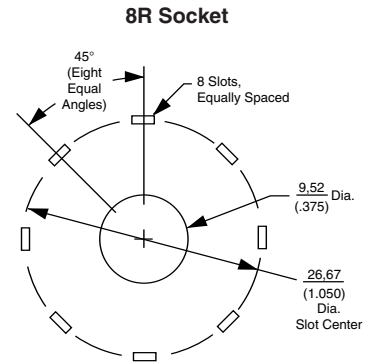

8R Socket

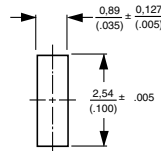



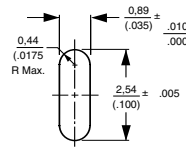

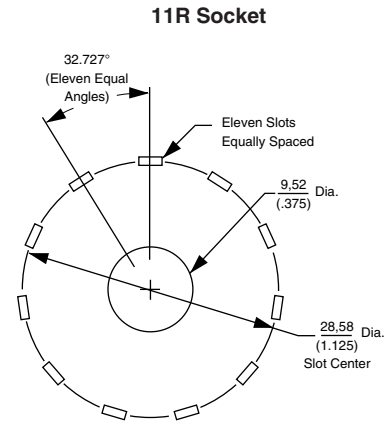

Punched Slot Detail



Routed Slot Detail



11R Socket

| Socket Style | Fits Relays | Part Number | Catalog Number |
|-------------------------------------------------------------------------------------|-------------|-------------|----------------|
|  | 2PDT | 2-1437683-2 | 8S-SOCKET |
|  | 3PDT | 1437661-1 | 11S-SOCKET |
|  | 2PDT | 1-1437683-1 | 21S-SOCKET |
|  | 4PDT | 1437683-3 | 14S-SOCKET |
|  | 8 pin octal | 2-1437683-1 | 8R-SOCKET |
|  | 11 pin | 1437683-1 | 11R-SOCKET |

Note: All part numbers are RoHS Compliant.

SNAPTRACK Channel



SNAPTRACK Channel can be mounted on standard DIN rails or A Series rail when used with TKAD. (Rails not included.)

SNAPTRACK Channel is a nonconductive, rigid extruded PVC chassis used for mounting socket assemblies and custom circuit boards. Available in a variety of fixed widths, including a split-apart version for wider PCB applications, SNAPTRACK Channel mounts to panels quickly with rivets or screws.

Printed circuit boards are simply snapped-in from the front, then held securely via intergral ribs which also serve as shock absorbers when the PCB is flexed. SNAPTRACK Channel permits easy, convenient PCB removal for field service. Slots on 2-inch centers are provided for fast, easy installation using either plastic rivets or other hardware. Double-faced tape may also be used effectively.

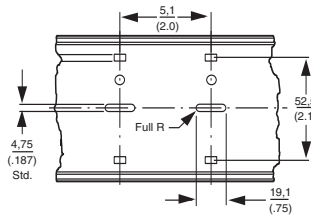

TK2D, 2TK2D, 3TK2D, 6TK2D Panel Mount, or use with TKAD to Mount on DIN Rail and A Series Rail

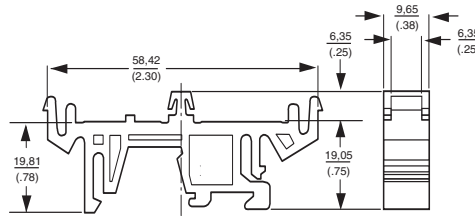

TKAD use with SNAPTRACK Channel to Mount on DIN Rail or A Series Rail

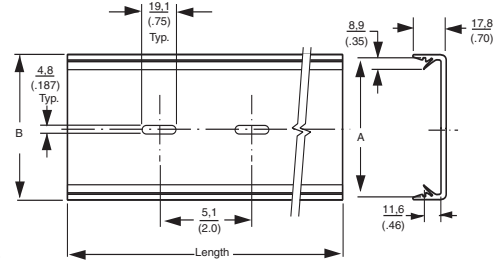

TK2, 3TK2, 8TK2, 2TK2, 6TK2 Panel Mount

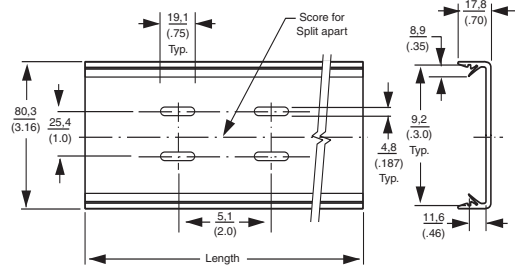

4TK2 Panel Mount

| Track Catalog No.* | Dimensions | |
|--------------------|--------------------|-----------------------|
| | A P.C. Board Width | B Overall Track Width |
| 8TK2-xx | 55.5 (2.187) | 58.4 (2.3) |
| 2TK2-xx | 69.9 (2.75) | 73.7 (2.9) |
| 2TK2D-xx | 69.9 (2.75) | 73.7 (2.9) |
| TK2-xx-AG | 76.2 (3.0) | 78.7 (3.1) |
| TK2D-xx-AG | 76.2 (3.0) | 78.7 (3.1) |
| 3TK2-xx | 82.6 (3.25) | 86.4 (3.40) |
| 3TK2D-xx | 82.6 (3.25) | 86.4 (3.40) |
| 6TK2-xx | 101.6 (4.0) | 105.4 (4.15) |
| 6TK2D-xx | 101.6 (4.0) | 105.4 (4.15) |
| 4TK2-xx | SPLIT-APART | — |

Note: Standard lengths are 3", 6", 12", 24", and 48". Custom lengths are available.

*Replace xx with track length.

Note: All part numbers are RoHS Compliant.

Accessories

Track Rivets

Plastic Track Rivet offers a low cost way to mount SNAPTRACK Channel. Requires 3/16" diameter hole in panels up to .125" thick. Cat. No. TR-1



TR-1 Track Rivet
1437645-6

Bails (Tie Downs)

Helps prevent relays and timers from vibrating out of sockets. RB1-AG and TB1, for general purpose relays and timers, feature adjustable height; mount on PC board with plastic mounting rivets (2) furnished. New economy RB5 spring bails fits most general purpose relays and timers. RB4 clip to miniature sockets. Stainless steel wire.

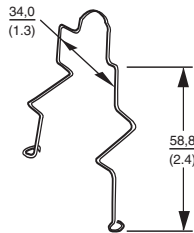

RB1-AG Relay Bail
2-1437683-3

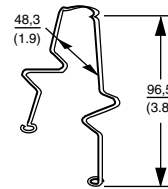

TB1 Timer Bail
3-1437683-0

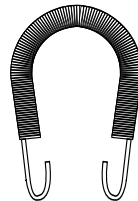

RB5-AG Universal Bail
2-1437683-6

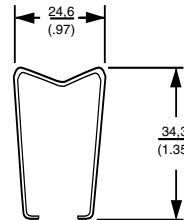

RB4-AG
2-1437683-5