



ELECTRONIC — ELECTRICAL TERMINAL BLOCKS



and RELAY SOCKETS

ELECTRICAL TERMINAL BLOCKS



SERIES/TYPE	SE/SEI	37000/ 38000	1500/2000	CB/CFT	AFTD	E	GFT/GB
TERMINAL SPACINGS Center-To-Center Spacing (Dimensions in parentheses equal mm.)	1/4" (6.35)	3/8" (9.52)	3/8" & 7/16" (9.52 & 11.11)	3/8" (9.52)	.325 (8.25)	3/8" (9.52)	7/16" (11.11)
Wire Range (AWG)	22 to 16	22 to 12	22 to 10	22 to 12	22 to 16	22 to 16	22 to 12
No. of Terminals	1 thru 26	1 thru 26	1 thru 22	1 thru 26	2 thru 17	1 thru 22	1 thru 26
TERMINAL TYPES							
Feed Thru (Fully Insulated)	•	•		•	•		•
Feed Thru	•	•	•	•		•	•
Printed Circuit	•	•	•	•		•	•
Surface (Fully Insulated)	•		•			•	•
RATING							
Voltage (Varies with Application. See Specifications.)	250V	300V	300V	600V	300V	250V	600V
Current (Amps)	5	20	30	20	10	15	20
HOUSING							
Material (Black) Phenolic *150° C (302° F)						•	
Polyphenylene *110° C (230° F)	•	•	•			•	•
Thermoplastic-Polyester *140° C (284° F)				•	•		
Flammability	94V-0	94V-0	94V-0	94V-0	94V-0	94V-0	94V-0
RECOGNITION							
Underwriter's Laboratories Components Laboratories	•	•	•	•	•	•	•
CSA Certified	•	•	•	•	•	•	•
FOR COMPLETE ENGINEERING SPECIFICATIONS SEE PAGES ...	4-5	6-9	10-11	12-14	15	16-17	18-20

The specifications and recommendations contained in this literature are subject to change without notice.

ELECTRICAL TERMINAL BLOCKS



SERIES/TYPE	71000	SW DSW	W DW		M	CDM/ CT	H/BT	T/U	L	O	S
TERMINAL SPACINGS Center-To-Center Spacing (Dimensions in parentheses equal mm.)	.629" (15.97)	3/8" (9.52)	7/16" (11.11)		1/2" (12.7)	35/64" (13.86)	.652" (16.56)	N/A	N/A	N/A	N/A
Wire Range (AWG)	1 to 22	22 to 8	22 to 8		22 to 12	CDM-22 to 10 CT-22 to 12	H-16 to 4 BT-22 to 10	T-6 to 1/0 U-6 to 250 MCM	Up to 1	Up to 1/0	Up to 4/0
No. of Terminals	3 thru 6	2 thru 192	2 thru 164		1 thru 24	1 thru 50	1 thru 30	1 thru 6	1 thru 12	1 thru 4	1 thru 4
MOUNTING METHOD Surface	•				•	•	•	•	•	•	•
Snap-in Track Modular Assembly	•	•	•								
RATING Voltage	600V	600V	600V		300V	600V	600V	600V	600V	600V	600V
Current (Amps)	85	25-50	25-50		15-25	30-20	75-30	125-250	100	125	225
HOUSING Material (Black) Phenolic *150° C (302° F)			•		•			•	•	•	•
Polyphenylene *110° C (230° F)						•	•				
Thermoplastic-Polyester *140° C (284° F)		*** •									
Flammability	94V-0	94V-2	94V-1		94V-1	94V-0	94V-0	94V-1	95V-1	95V-1	95V-1
RECOGNITION Underwriter's Laboratories Components Laboratories	•	•	•		•	•	•	•	•	•	•
CSA Certified	•	•	•		•	•	•	•	•	•	•
FOR COMPLETE ENGINEERING SPECIFICA- TIONS SEE PAGES ...	21	22-23	24-25		28-29	30-31	32-33	34-35	34-35	34-35	34-35

* Continuous Use Temperature UL Index

*** Material – White



FEATURES

- **MINIATURE FEED-THRU, PRINTED CIRCUIT AND SURFACE CONNECTION** – SE Series miniature terminal blocks are designed for applications requiring the compactness and versatility of the SEI Series without full feed-thru insulation.
- **BARRIER-TYPE CONSTRUCTION** – Blocks are made of high-impact, break-resistant thermoplastic molding with integrally mounted .116 inch diameter mounting holes. One thru 26 terminals on 1/4 inch center-to-center spacing.
- **TERMINAL FLEXIBILITY** – External terminals available in two No. 2-56 screw designs. Internal terminals include an .047 inch diameter printed circuit pin, and turret-type solder pins.
- **WIRE SIZES** – No. 2-56 screws. UL recognized for No. 22 AWG to No. 16AWG.
- **RECOGNITION AND LISTING** – UL recognized.
- **STANDOFFS** – SEPX and SEFX are now supplied with .020 inch standoffs for ease in cleaning after soldering.



Recognized under the Components Program of Underwriters Laboratories, Inc. Standard 1059, Guide No. XCFR2, File No. E62557.

Guide No. 184-N-90, Report No. LR39186-1.

VARIATIONS

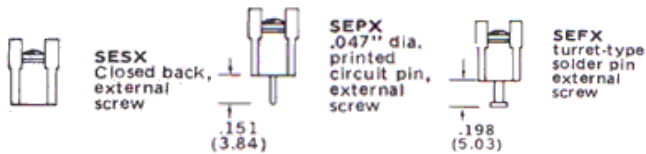

INTERNAL TERMINAL DESIGNATIONS

- SESX** Closed-back design which can be mounted on metal surface with no additional insulation required.
- SEPX, SEIPX** Printed circuit board design with .047" tin-plated brass pin.
- SEFX, SEIFX** Tin-plated brass turret-type solder pin.



EXTERNAL TERMINAL DESIGNATIONS

- SESX, SEPX, SEFX, SEIPX, SEIFX** No. 2-56 plated steel* terminal screw accepting up to No. 16AWG wire.
- SESCX, SEPCX, SEFCX, SEIPCX, SEIFCX** Nickel-plated brass surface clamp with No. 2-56 plated steel* screw to eliminate lugging. Accepts wire up to No. 16AWG.

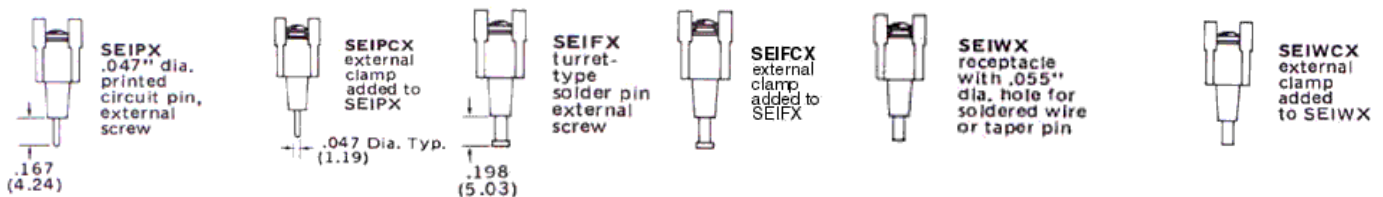

ENGINEERING SPECIFICATIONS

Center-to-Center Spacing: 1/4" (6.35 mm)

Wire Range: UL recognized for No. 22AWG to No. 16AWG. Models SESX, SEIPX, SEIFX, SEPX and SEFX with standard No. 2-56 plated steel screw are UL recognized "for factory wiring only." Models SESCX, SEPCX, SEFCX, SEIPCX and SEIFCX are UL recognized "for field wiring" when ordered with special No. 2-56 stainless steel screw.

Number of Terminals: 1 thru 26

Voltage Rating: UL & CSA – 150 volts – General Industrial
250 volts – Commercial Appliance

Tightening Torque: Wire clamp with stainless steel screw 3 in.-lbs.

Current Rating: 5 amps UL

Housing: "X" Grade
Material; Polyphenylene Oxide
Continuous Use Temp.; 110° C (230° F)
(UL Index)
Flammability Rating; 94V-0
Water Absorption; (24 hrs. % wt. gain) .06%
Chemical Resistance: Resistant to inorganic bases and acids – for organic substances contact factory for specific resistance.

Breakdown Voltage:
Terminal - Terminal: 3,600V Typ.
Terminal - Ground: 4,700V Typ.

NOTE: Specifications contained herein are subject to change without notice.

PC BOARD DRILLING DIMENSIONS

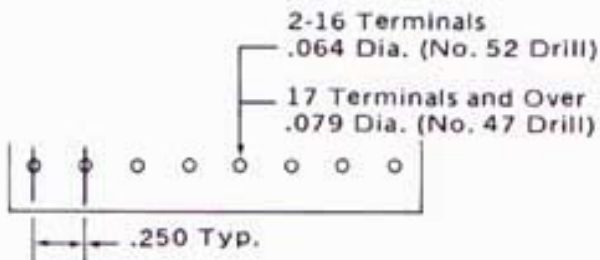

DIMENSIONS

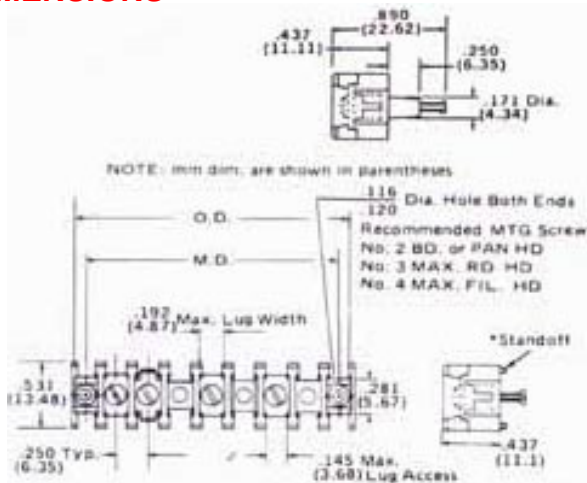

HOW TO ORDER

SEI and SE Series terminal blocks are ordered by listing a composite number made up of the model designation followed by the number of poles required for the application.

Suffixes are used as follows:

R denotes model less mounting positions.

* The SEPX and SEFX are made with .020" standoffs for ease in cleaning after the soldering operation.

No. of Terminals	Mounting Dimensions		Overall Dimensions		Less Mounting Positions	
	Inches	Metric (mm)	Inches	Metric (mm)	Inches	Metric (mm)
1	.500	12.70	.781	19.84	.375	9.52
2	.750	19.05	1.031	26.19	.625	15.87
3	1.000	25.40	1.281	32.54	.875	22.22
4	1.250	31.75	1.531	38.89	1.125	28.57
5	1.500	38.10	1.781	45.24	1.375	34.92
6	1.750	44.45	2.031	51.59	1.625	41.27
7	2.000	50.80	2.281	57.94	1.875	47.62
8	2.250	57.15	2.531	64.29	2.125	53.97
9	2.500	63.50	2.781	70.64	2.375	60.32
10	2.750	69.85	3.031	76.99	2.625	66.67
11	3.000	76.20	3.281	83.34	2.875	73.02
12	3.250	82.55	3.531	89.69	3.125	79.37
13	3.500	88.90	3.781	96.04	3.375	85.72
14	3.750	95.25	4.031	102.39	3.625	92.07
15	4.000	101.60	4.281	108.74	3.875	98.42
16	4.250	107.95	4.531	115.09	4.125	104.77
17	4.500	114.30	4.781	121.44	4.375	111.12
18	4.750	120.65	5.031	127.79	4.625	117.47
19	5.000	127.00	5.281	134.14	4.875	123.82
20	5.250	133.35	5.531	140.49	5.125	130.17
21	5.500	139.70	5.781	146.84	5.375	136.52
22	5.750	146.05	6.031	153.19	5.625	142.87
23	6.000	152.40	6.281	159.54	5.875	149.22
24	6.250	158.75	6.531	165.89	6.125	155.57
25	6.500	165.10	6.781	172.24	6.375	161.92
26	6.750	171.45	7.031	178.59	6.625	168.27

Dimensions shown are ±0.030".



FEATURES

- Complete line of 3/8 inch centerline terminal block styles. Terminal blocks come in surface mount, PC mount, panel mount, and feed-thru styles with a wide variety of top and bottom terminations available.
- Compliant contact design virtually eliminates solder joint fractures due to pin twist.
- Standoffs are molded into blocks to prevent trapping solder flux and to aid in the board cleaning process.
- Broad wire range. The 37000/38000 Series terminal blocks will accommodate wire sizes up to 12AWG.
- Full line of accessories complements the 37000/38000 Series terminal blocks, offering greater design flexibility.
- All Curtis terminal blocks for electronic applications are made from self-extinguishing material rated 94V-0 by Underwriters Laboratories, Inc.
- Customized terminal blocks are available for special applications by consulting any authorized Curtis distributor, Curtis representative, or by contacting the Curtis factory direct.



Recognized under the Components Program of Underwriters Laboratories, Inc. Standard 1059, Guide No. XCFR2, File No. E62557.

Guide No. 184-N-90, Report No. LR39186-1.

VARIATIONS

SERIES 37000

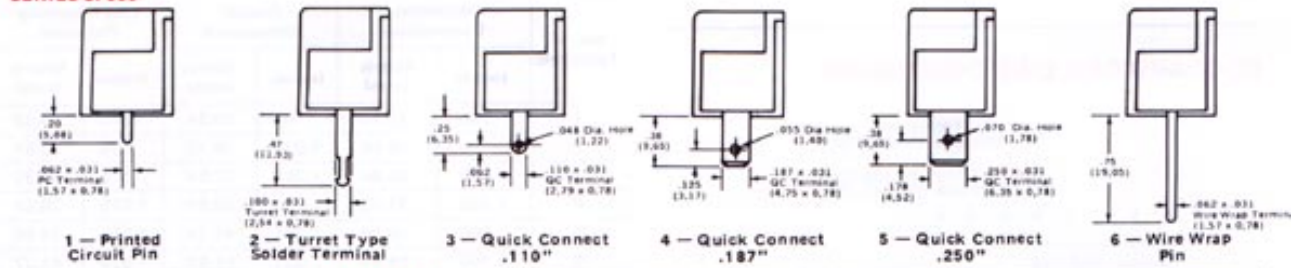

SERIES 38000

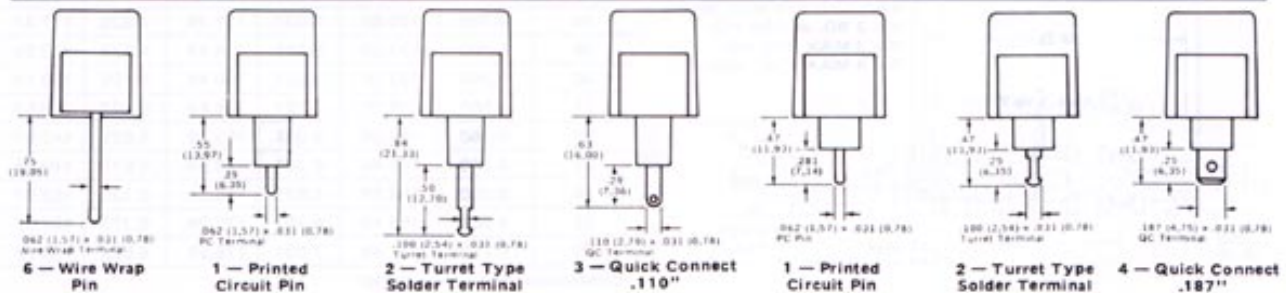
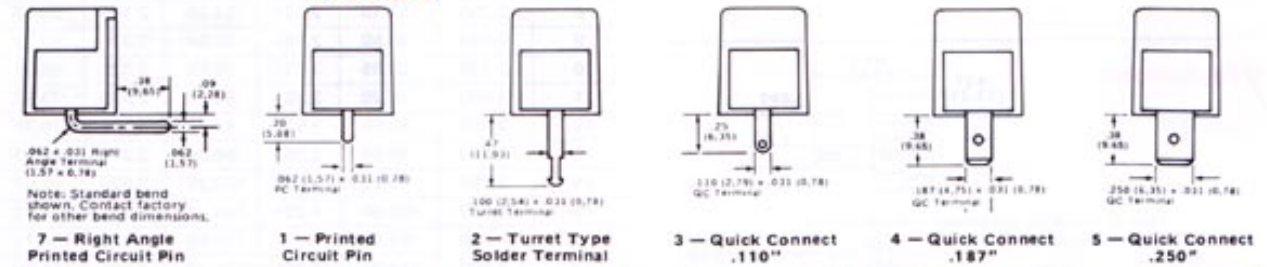

SERIES 37000
Surface Mount
with
Mounting Ears

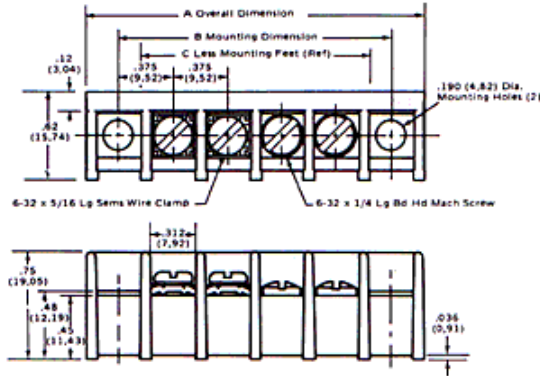

ENGINEERING SPECIFICATIONS

Center-to-Center Spacing: 3/8" (9.52 mm)

Wire Range: No. 22AWG to No. 12AWG.

Number of Terminals: 1 thru 26 (28 positions on surface mount without mounting ears)

Voltage Rating: 300 volts

Tightening Torque: Wire Binding Screw 9 in.-lbs.
Wire Clamp 9 in.-lbs.

Current Rating: 20 amps

Housing:

Material: Polyphenylene

Continuous Use Temp.: 115° C
(UL Index)

Flammability Rating: 94V-0

Water Absorption: .03%

Chemical Resistance: Excellent

Breakdown Voltage: 3,000V Typ.

Terminals: Brass, tin-plated.

SERIES 37000
Surface Mount
without
Mounting Ears

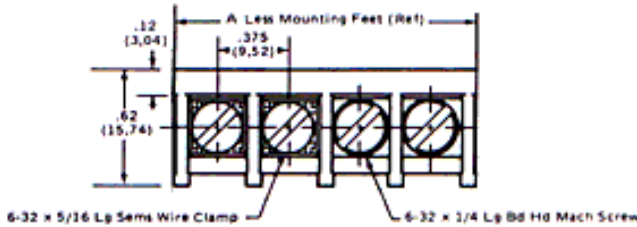

SERIES 37000 and 38000
WITHOUT MOUNTING EARS

No. of Terminals	A±.031 Less Mounting Ears (Ref.)	No. of Terminals	A±.031 Less Mounting Ears (Ref.)
1	--	14	5.325
2	.825	15	5.700
3	1.200	16	6.075
4	1.575	17	6.450
5	1.950	18	6.825
6	2.325	19	7.200
7	2.700	20	7.575
8	3.075	21	7.950
9	3.450	22	8.325
10	3.825	23	8.700
11	4.200	24	9.075
12	4.575	25	9.450
13	4.950	26	9.825

SERIES 38000
Surface Mount
with
Mounting Ears

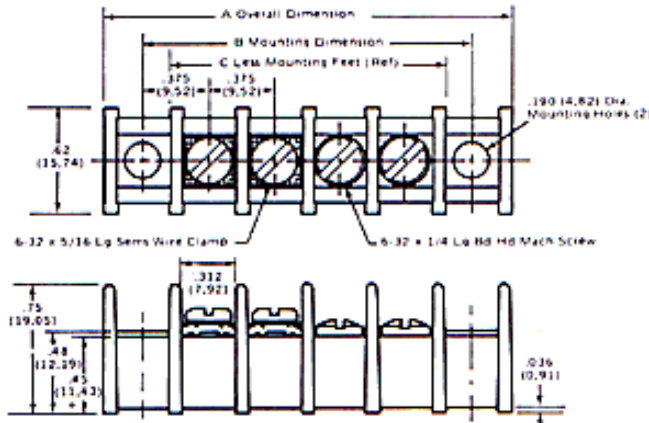

SERIES 37000 and 38000
WITH MOUNTING EARS

No. of Terminals	A±.031 Overall Dim.	B±.031 Mounting Dim.	C±.031 Less Mt. Ft. (Ref.)	No. of Terminals	A±.031 Overall Dim.	B±.031 Mounting Dim.	C±.031 Less Mt. Ft. (Ref.)
1	1.200	.750	--	14	6.075	5.625	5.325
2	1.575	1.125	.825	15	6.450	6.000	5.700
3	1.950	1.500	1.200	16	6.825	6.375	6.075
4	2.325	1.875	1.575	17	7.200	6.750	6.450
5	2.700	2.250	1.950	18	7.575	7.125	6.825
6	3.075	2.625	2.325	19	7.950	7.500	7.200
7	3.450	3.000	2.700	20	8.325	7.875	7.575
8	3.825	3.375	3.075	21	8.700	8.250	7.950
9	4.200	3.750	3.450	22	9.075	8.625	8.325
10	4.575	4.125	3.825	23	9.450	9.000	8.700
11	4.950	4.500	4.200	24	9.825	9.375	9.075
12	5.325	4.875	4.575	25	10.200	9.750	9.450
13	5.700	5.250	4.950	26	10.575	10.125	9.825

SERIES 38000
Long Feed-Thru

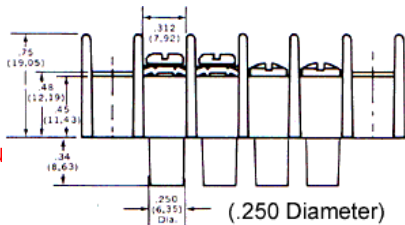

SERIES 38000
Short Feed-Thru

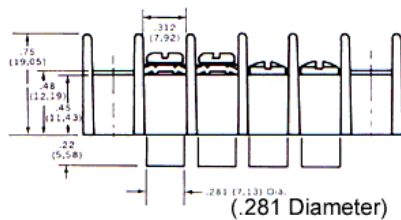

HOW TO ORDER SERIES 37000

Molding	Insert or Bottom Termination	Insert/Screw Dimension	Hardware or Top Termination Design	Number of Positions	Special or Optional Designs
37	1	2	1	15	0
0 - Surface Mount w/ Mounting Ears 1 - Surface Mount w/o	0 - Surface Mount, No Bottom Termination 1 - Printed Circuit Pin 2 - Turret Type Solder Terminal 3 - Quick Connect - .110" 4 - Quick Connect - .187" 5 - Quick Connect - .250" 6 - Wire Wrap Pin 7 - Right Angle Printed Circuit	0 - Nickel Plated Steel Screw, Standard 1 - Wire Clamp Screws 2 - Nickel Plated Brass Screws 3 - Stainless Steel Screw 4 - Slotted Phillips Head Screws 5 - Without Screws 6 - Quick Connects, Screw Type* 8 - Captivated Screw	01 thru 26. Available in one to twenty-six positions	0 - No additional options A thru Z - to be assigned by factory to designate special options	

RECOMMENDED P.C. BOARD DRILLING DIMENSIONS

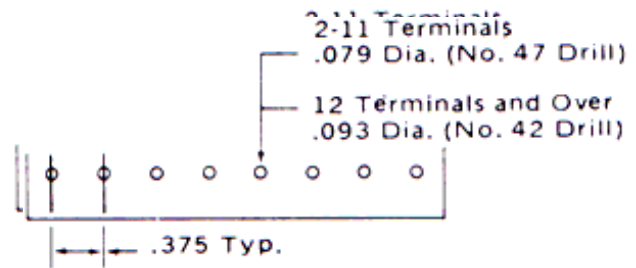

RECOMMENDED PANEL CUTOUT DIMENSIONS

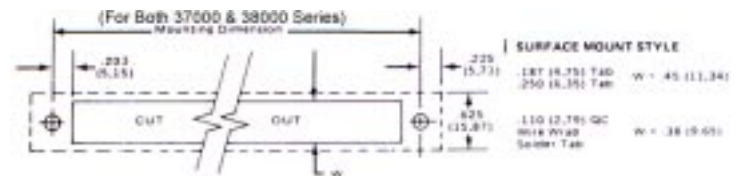

HOW TO ORDER SERIES 38000

Molding	Insert or Bottom Termination	Insert/Screw Dimension	Hardware or Top Termination Design	Number of Positions	Special or Optional Designs
38	1	2	1	15	0
0 - Surface Mount w/ Mounting Ears 1 - Surface Mount w/o Mounting Ears 2 - Insulated Feed Thru .250 Diameter w/Mounting Ears 3 - Insulated Feed Thru .250 Diameter w/o Mounting Ears 4 - Insulated Feed Thru .281 Diameter w/Mounting Ears 5 - Insulated Feed Thru .281 Diameter w/o Mounting Ears	0 - Surface Mount, No Bottom Termination 1 - Printed Circuit Pin 2 - Turret Type Solder Terminal 3 - Quick Connect - .110" 4 - Quick Connect - .187" 5 - Quick Connect - .250" 6 - Wire Wrap Pin 7 - Right Angle Printed Circuit	0 - Nickel Plated Steel Screw, Standard 1 - Wire Clamp Screws 2 - Nickel Plated Brass Screws 3 - Stainless Steel Screw 4 - Slotted Phillips Head Screws 5 - Without Screws 6 - Quick Connects, Screw Type* 8 - Captivated Screw	01 thru 26. Available in one to twenty-six positions	0 - No additional options A thru Z - to be assigned by factory to designate special options	

RECOMMENDED P.C. BOARD DRILLING DIMENSIONS

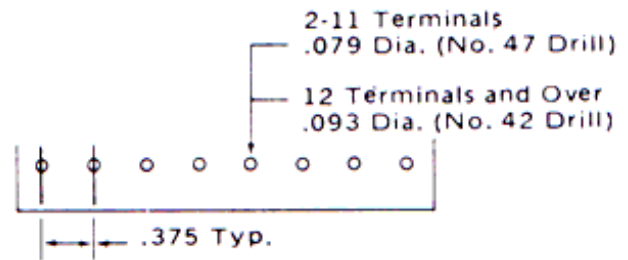

RECOMMENDED PANEL CUTOUT DIMENSIONS

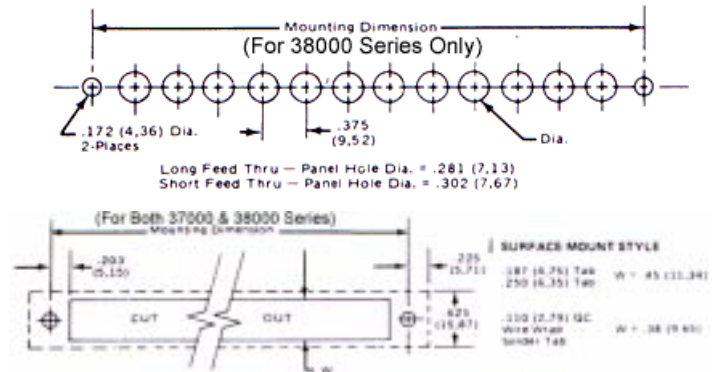

**ACCESSORIES SERIES 37000
QUICK-CONNECT TERMINALS**

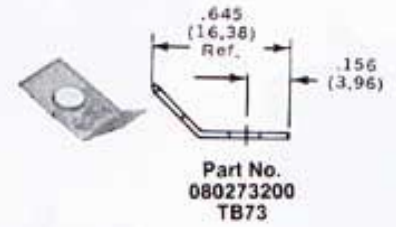
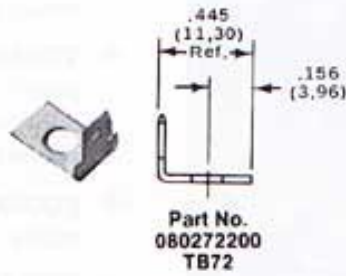
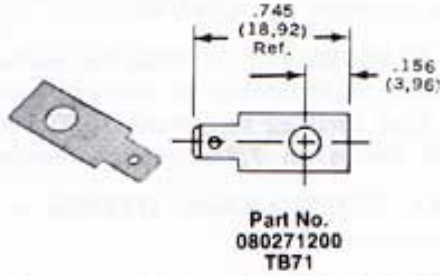

**COMMON ACCESSORIES
SERIES 37000 AND 38000**

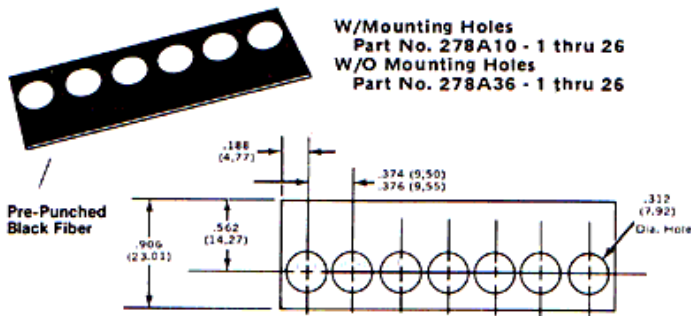

TERMINAL BLOCK JUMPERS

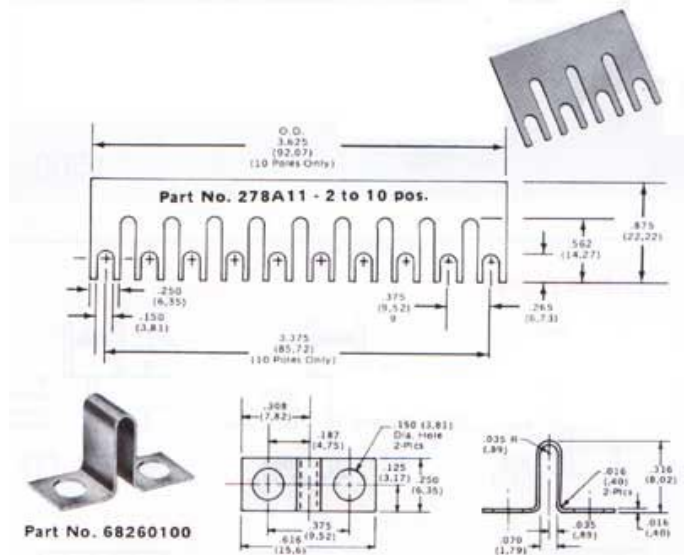

**ACCESSORIES SERIES 38000
QUICK-CONNECT TERMINALS**

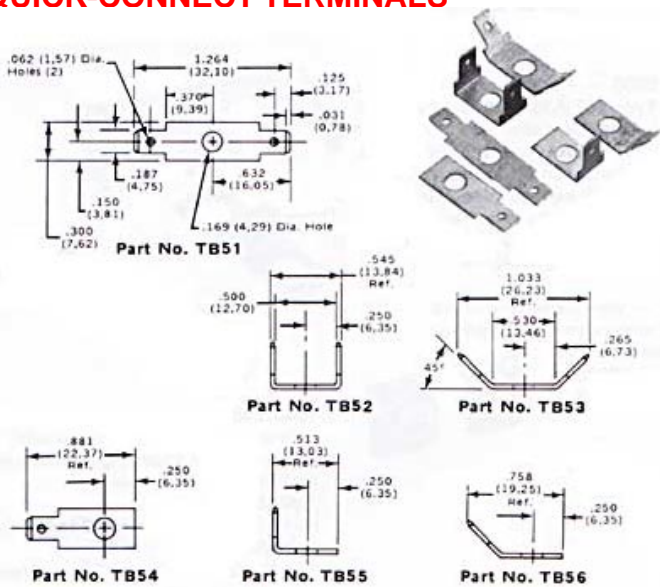

TINNERMAN NUTS

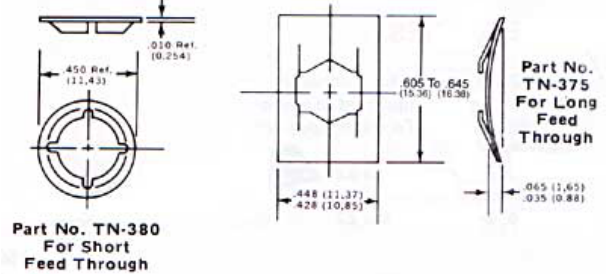

COVERS

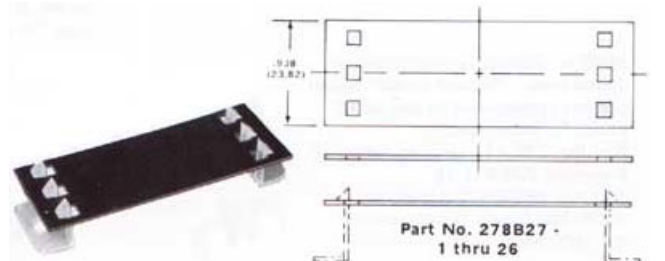

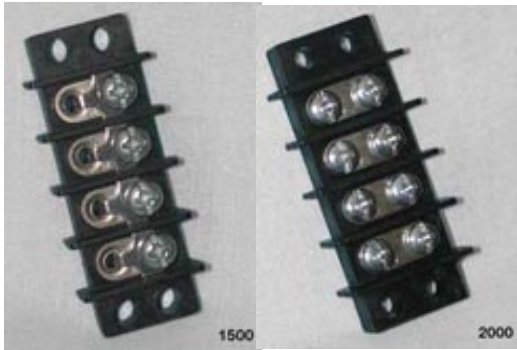

FEATURES

- **FLEXIBLE HI-TEMP THERMOPLASTIC TERMINAL BLOCKS** – Self-extinguishing types which resist breakage and other damage (conform to UL94V-0)
- **TERMINAL FLEXIBILITY** – Ideal for surface mount, sub-panel or chassis connections in electronic/electrical circuit applications. One thru 22 terminals. 1500 Series on 3/8 inch centers, 2000 Series on 7/16 inch center-to-center spacing.
- **ECONOMICAL CLOSED-BACK DESIGN** – No need for costly insulation strip.
- **BROAD WIRE RANGE** – No. 6-32 external twin screws, UL recognized for No. 22AWG to No. 10AWG. Variations include double solder lug, single solder lug, wire wrap, solder pin and printed circuit pin.
- **UL/CSA ELECTRICAL RATINGS** – UL 30 amps/1100 volts RMS (1/3 breakdown voltage), CSA rating: 15 amps/300 volts (1500 Series), 20 amps/300 volts (2000 Series).
- **RECOGNITION AND LISTING** – Various terminal types are UL recognized and CSA certified.



Recognized under the Components Program of Underwriters Laboratories, Inc. Standard 1059, Guide No. XCFR2, File No. E62557.

Guide No. 184-N-90, Report No. LR39186-1. COMPLIES WITH 947-7-1.

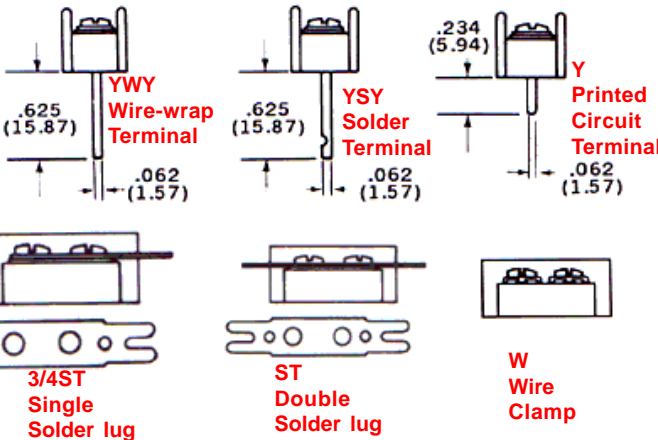

INTERNAL TERMINAL DESIGNATIONS

1500/2000-Y	Printed circuit board design with .062" x .031" solderable tin-plated pin
1500/2000-YSY	Feed-thru solder pin
1500/2000-YWY	Feed-thru wire wrap

EXTERNAL TERMINAL DESIGNATIONS

1500/2000	Screw terminal with No. 6-32 plated steel* screw accepting up to No. 10AWG wire.
1500/2000-ST	Solderable tin-plated double solder tab
1500/2000-3/4ST	Solderable tin-plated single solder tab
1500/2000-W	Wire clamp captivated to a No. 6-32 plated steel screw

* Other materials available – contact factory or your local representative for additional information.

ACCESSORIES

1500/2000 – May be purchased blank or factory imprinted to customer requirement. To order, specify:
1500 Series –
Part No. 247A10-1 thru 22
2000 Series
Part no. 247A11-1 thru 22

1500 – Jumper is constructed of plated brass. "Rooster comb" design permits connections to two to 10 poles. To order, specify:
Part No. 278-A11 (plus no. of poles)
Example: 278-A11-10
Part No. 68240100 (Holes) or
68245100 (slots) (2-pole jumper for 1500 only)

2000 – Plated brass in two styles. Type 267-A28 is designed to jump two adjacent terminals as it is channeled to cross over the barrier top. "Rooster comb" design of Type 267-A42 permits connections of two to 18 poles. To order, specify: Part no. 267-A42 (Plus No. of poles)
Example: 267-A42-18

1500/2000 – Wire clamp captivated to No. 6-32 screw eliminates need for lugs. To order, specify:
Part No. 1500 58525
Part No. 2000 58526



1500/2000 – Rigid .030" thick self-extinguishing vinyl. Complete with spring clips for attaching to mounting positions. To order, specify:
1500 Series –
Part No. 247B24-1 thru 22 terminals
2000 Series –
Part No. 247B25-1 thru 22 terminals

2000 - 7/16" (11.11 mm) Center-to-Center Spacing

ENGINEERING SPECIFICATIONS

- Center-to-Center Spacing:** 1500 Series 3/8" (9.52 mm)
2000 Series 7/16" (11.11 mm)
- Wire Range:** 2000 Series up to No. 10AWG. 1500 Series up to No. 12AWG. (CSA requires use of lugs on wire larger than No. 16AWG.)
- Number of Terminals:** 1 thru 22
- Voltage Rating:** CSA – 300 volts
UL – 150 volts General Industrial
250 volts Commercial Appliance
300 volts – Limited Energy Industrial
- Current Rating:** UL: 2000 Series 30 amps, 1500 Series 20 amps.
(CSA: 2000 Series 20 amps, 1500 Series 15 amps)
- Tightening Torque:** **1500** **2000**
12 in.-lb. 12 in.-lb.
9 in.-lb. 9 in.-lb.

Housing:

- Material:** Polyphenylene Oxide
- Continuous Use Temp.:** 110° C (230° F)
(UL Index)
- Flammability Rating:** 94V-0
- Water Absorption:**
(24 hrs. % wt. gain) .06%
- Chemical Resistance:** Resistant to inorganic bases and acids.
For organic substances contact factory for specific resistance.

NOTE: Specifications contained herein are subject to change without notice.

PC BOARD DRILLING DIMENSIONS

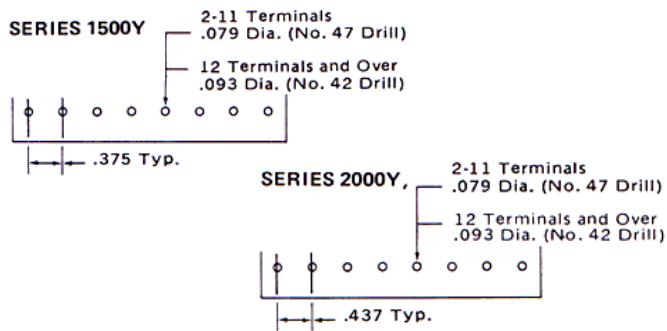

1500/2000 – Available with .187" x .020" quick-connect tabs for 1500 Series; .250" x 0.32" for 2000 Series. Nine styles ...tin-plated brass tabs held in place by terminal screws. Up to six terminations per pole. To order, specify:

1500 Series: Parts Nos. TB1-19
2000 Series: Parts Nos. TB31-39
Last digit of part number corresponds to previous style numbers.



HOW TO ORDER

Stock number 1500 is used for terminal blocks on 3/8" centers and 2000 for terminals on 7/16" centers.

1500/2000 Series terminal blocks are ordered by listing a composite number made up of the model designation in which the last two digits indicate the number of poles required for the application. Example: A 1500 10-terminal block (3/8" centers) becomes stock number 1510; with 7/16" centers) 2010.

Suffixes are used as follows:

- | | | | |
|-------|-----------------------------|-----|----------------------|
| ST | denotes double solder lug | YSY | feed-thru solder pin |
| 3/4ST | denotes single solder lug | YWY | feed-thru wire wrap |
| Y | denotes printed circuit pin | W | wire clamp |

The 1510 described above, with double solder lug mounting on 3/8 inch centers thus converts to stock number 1510-ST. To specify quick-connect terminals, simply add the style number required. (See accessories on page 10). May be purchased factory-assembled or as customer-installed accessory.

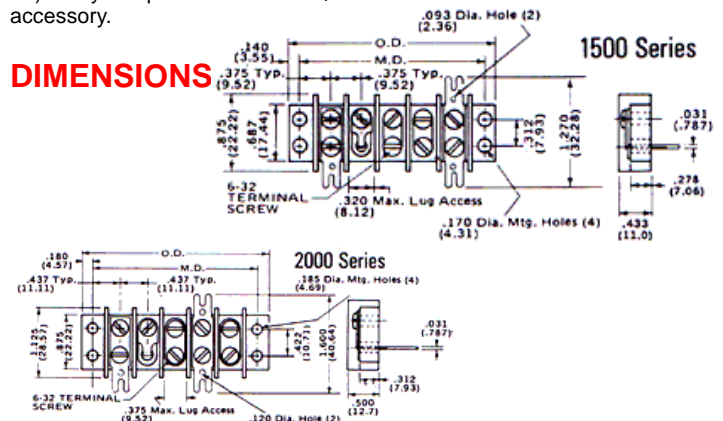

	Mounting Dimensions		Overall Dimensions		Mounting Dimensions		Overall Dimensions	
	Inches	Metric (mm)	Inches	Metric (mm)	Inches	Metric (mm)	Inches	Metric (mm)
1	.750	19.05	1.030	26.16	.875	22.22	1.235	31.36
2	1.125	28.57	1.405	35.68	1.312	33.33	1.672	42.48
3	1.500	38.10	1.780	45.21	1.750	44.45	2.110	53.59
4	1.875	47.62	2.155	54.73	2.187	55.56	2.547	64.70
5	2.250	57.15	2.530	64.26	2.625	66.67	2.985	75.81
6	2.625	66.67	2.905	73.78	3.062	77.78	3.422	86.93
7	3.000	76.20	3.280	83.31	3.500	88.90	3.860	98.04
8	3.375	85.72	3.655	92.83	3.937	100.01	4.297	109.15
9	3.750	95.25	4.030	102.36	4.375	111.12	4.735	120.26
10	4.125	104.77	4.405	111.88	4.812	122.23	5.172	131.38
11	4.500	114.30	4.780	121.41	5.250	133.35	5.610	142.49
12	4.875	123.82	5.155	130.93	5.687	144.46	6.047	153.60
13	5.250	133.35	5.530	140.46	6.125	155.57	6.485	164.71
14	5.625	142.87	5.905	149.98	6.562	166.68	6.922	175.83
15	6.000	152.40	6.280	159.51	7.000	177.80	7.360	186.94
16	6.375	161.92	6.655	169.03	7.437	188.91	7.797	198.05
17	6.750	171.45	7.030	178.56	7.875	200.02	8.235	209.16
18	7.125	180.97	7.405	188.08	8.312	211.13	8.672	220.28
19	7.500	190.50	7.780	197.61	8.750	222.25	9.110	231.39
20	7.875	200.02	8.155	207.13	9.187	233.36	9.547	242.50
21	8.250	209.55	8.530	216.66	9.625	244.47	9.985	253.61
22	8.625	219.07	8.905	226.18	10.062	255.58	10.422	264.73

Dimensions shown are ±0.030".

CURTIS SERIES CB, CFT and CFTD

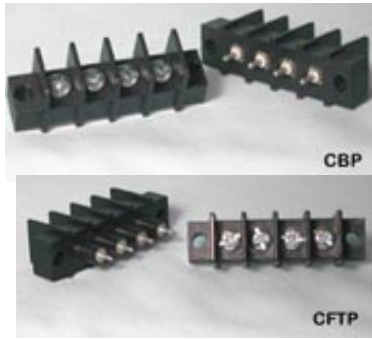

FEATURES

- **COMPACT BARRIER-TYPE DESIGN** – Especially suited for electronic and control feed-thru applications where space saving is required.
- **FULLY INSULATED FEED-THRU, DISCONNECT, PRINTED CIRCUIT OR SURFACE CONNECTION** – One thru 26 terminals on 3/8 inch center-to-center spacing.
- **IMPROVED HIGH BARRIER DESIGN** – Meets industrial contact clearance and creepage requirements set by UL. Rated 20 amps/up to 600 volts.
- **SUITABLE FOR HIGH MOISTURE AND DUST ENVIRONMENTS** – Blocks are made of break-resistant, high-impact black thermoplastic.
- **SOLID CONSTRUCTION** – Terminals are molded in place with precision screw machined brass inserts which will not twist, virtually eliminating broken solder joints while providing a full mechanical thread system.
- **BROAD WIRE RANGE** – No. 6-32 external terminal screw UL recognized for No. 22AWG to No. 12AWG.
- **RECOGNITION AND LISTING** – UL recognized and CSA certified.



Recognized under the Components Program of Underwriters Laboratories, Inc. Standard 1059, Guide No. XCFR2, File No. E62557.

Guide No. 184-N-90, Report No. LR39186-1.

VARIATIONS

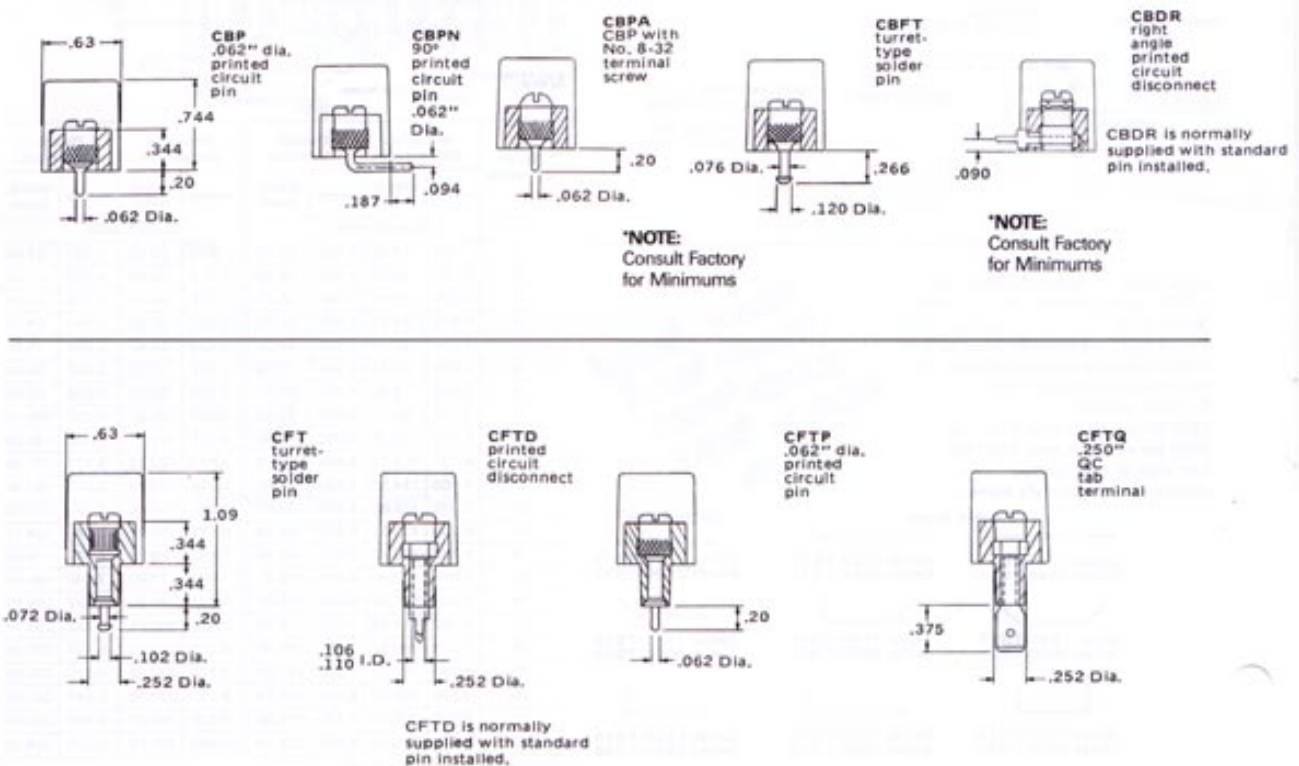

3/16" (9.52 mm) Center-to-Center Spacing

ENGINEERING SPECIFICATIONS

Center-to-Center Spacing: 3/8" (9.52 mm)

Wire Range: No. 22AWG to No. 12AWG.

Number of Terminals: 1 thru 26

Voltage Rating: CSA – 300 volts

- Screw Terminals
 - UL – 600 volts – Limited Energy Devices
 - UL – 300 volts – General Industrial
 - Quick Connects: UL – 125 volts – Commercial Appliance

Current Rating: 20 amps

Tightening Torque: Wire Binding Screw 12 in.-lb.
Wire Clamps 20 in.-lb.

Housing:

- Material: Thermoplastic Polyester
- Continuous Use Temp.; (UL Index): 140° C (284° F)
- Flammability Rating: 94V-0
- Water Absorption: .08%
- Chemical Resistance: Excellent in most environments.

Breakdown Voltage:

- Terminal - Terminal: 7,000V Typ.
- Terminal - Ground: 6,000V Typ.

Terminals: Solid Brass.

Solder style terminals are plated with high-purity tin for optimum solderability.

Contact Resistance: .002 ohm Typ. – CFTD

NOTE: Specifications contained herein are subject to change without notice.

HOW TO ORDER

CFT Series terminal blocks are ordered by listing designation followed by the number of poles required for the application. Example: Type CFT 10-pole block becomes stock number CFT-10.

Suffixes are used as follows:

- W denotes model with wire clamp replacing external screw terminal
- C denotes model less mounting positions
- A denotes model with 8-32 terminal (CBP only)

To specify quick-connect terminals, simply add the style number required.

May be purchased factory-assembled or as customer-installed accessory.

The CFT-10 described above with wire clamp less mounting positions thus converts to stock number CFTWC-10.

INTERNAL TERMINAL DESIGNATIONS

- CBP Printed circuit board design with .062" diameter tin-plated brass pin.
- CBFT Tin-plated brass turret-type solder pin.
- CBPN .062" diameter printed circuit pin designed for right angle mounting.
- CFT Tin-plated brass turret-type solder pin.
- CFTP Printed circuit board design with .062" diameter tin-plated brass pin.
- CFTQ .250" quick connect tab terminal.
- CFTD Disconnect design with factory installed pin terminals for printed circuit mounting.
- CBDR Right angle disconnect design.

EXTERNAL TERMINAL DESIGNATIONS

- CBP, CBFT, CFT, CBPN, CFTP, CFTD, CBDR Screw terminal with No. 6-32 plated steel* screw accepting wire up to No. 12AWG.
- CBPA Screw terminal with No. 8-32 slotted head screw, nickel plated steel
- CBPW, CFTW, CBPNW, CBFTW, CFTPW, CFTQW, CFTDW, CBDRW 6-32 slotted head screw with captivated traveling wire clamp.

* Other materials available – contact factory or your local representative for additional information.

DETAIL OF PC DISCONNECT PIN (CBDR/CFTD)

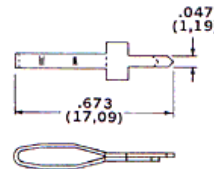

SPECIAL
80509600

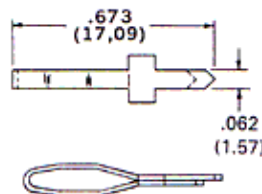

STANDARD
80821600

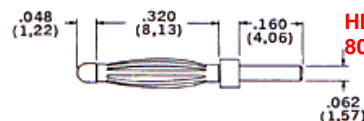

HIGH RELIABILITY PIN
80900010

CURTIS SERIES CB, CFT and CFTD

PC BOARD DRILLING DIMENSIONS

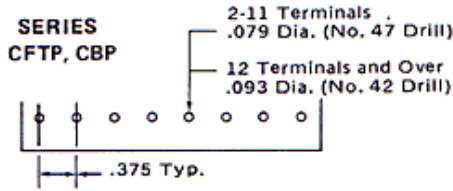

DIMENSIONS

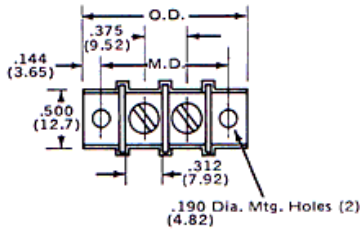

No. of Terminals	Mounting Dimensions		Overall Dimensions		Less Mounting Positions	
	Inches	Metric (mm)	Inches	Metric (mm)	Inches	Metric (mm)
1	.750	19.05	1.062	26.98	.437	11.11
2	1.125	28.57	1.437	36.51	.812	20.63
3	1.500	38.10	1.812	46.03	1.187	30.16
4	1.875	47.62	2.187	55.56	1.562	39.68
5	2.250	57.15	2.562	65.08	1.937	49.21
6	2.625	66.67	2.937	74.61	2.312	58.73
7	3.000	76.20	3.312	84.13	2.687	68.26
8	2.250	57.15	2.531	64.29	2.125	53.97
9	3.375	85.72	3.687	93.66	3.062	77.78
10	4.125	104.77	4.437	112.71	3.812	96.83
11	4.500	114.30	4.812	122.23	4.187	106.36
12	4.875	123.82	5.187	131.76	4.562	115.88
13	5.250	133.35	5.562	141.28	4.937	125.41
14	5.625	142.87	5.937	150.81	5.312	134.93
15	6.000	152.40	6.312	160.33	5.687	144.46
16	6.375	161.92	6.687	169.86	6.062	153.98
17	6.750	171.45	7.062	179.38	6.437	163.51
18	7.125	180.97	7.437	188.91	6.812	173.03
19	7.500	190.50	7.812	198.43	7.187	182.56
20	7.875	200.02	8.187	207.96	7.562	192.08
21	8.250	209.55	8.562	217.48	7.937	201.61
22	8.625	219.07	8.937	227.01	8.312	211.13
23	9.000	228.60	9.312	236.53	8.687	220.66
24	9.375	238.12	9.687	246.06	9.062	230.18
25	9.750	247.65	10.062	255.58	9.437	239.71
26	10.125	257.17	10.437	265.11	9.812	249.23

Dimensions shown are ±0.030".

ACCESSORIES

QUICK-CONNECT TERMINALS

CB/CFT – Available with .187" x .020" quick-connect tabs of tinned brass, held in place by terminal screws. Six styles...one to six terminations per pole. Factory-assembled or customer-installed. Last digit of part number corresponds to previous style numbers.

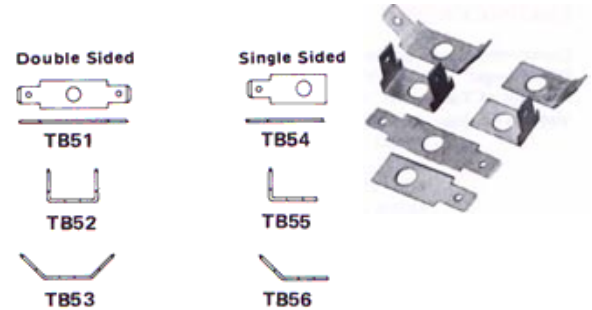

TINNERMAN NUT

CFT – For speed mounting of terminal blocks less mounting positions. Part No. TN-375

MARKING STRIPS

CB/CFT – Pre-punched black fiber...mount under block. May be imprinted to customer specifications. To order, specify: Part No. 278A10-1 thru 26 (with mounting hole) Part No. 278A36-1 thru 26 (less mounting hole)

COVERS

CB/CFT – Rigid .030" thick self-extinguishing vinyl. Black matte-finished on both sides. May double as marking strip when imprinted with white ink. Complete with spring clips for attaching to mounting positions.

To order specify:
 CB/CFT Series –
 Part No. 278B27-1 thru 26 terminals.

TERMINAL BLOCK JUMPERS

CB/CFT – Jumper is constructed of plated brass. "Rooster comb" design permits connections of two to 10 poles.

To order, specify:
 part No. 278-A11 (plus no. of poles)
 Example: 278-A11-10.

WIRE CLAMPS

CB/CFT – Wire clamp captivated to No. 6-32 screw eliminates need for lugs. Accepts No. 14AWG wire. Part No. 58537.

Terminal blocks are normally supplied with No. 6-32 slotted head screws, combination slotted phillips head screws are available as are other styles and materials on special order.

SERIES AFTD

.325"
Center-to-Center Spacing



DISCONNECT TERMINAL ENGINEERING SPECIFICATIONS

Center-to-Center Spacing: .325"
Wire Range: No. 22AWG to No. 16AWG.
Number of Terminals: 2 thru 17
Voltage Rating: 300 volts. UL and CSA.
Current Rating: 10 amps. UL and CSA.
Tightening Torque: Wire Clamp 12 in.-lb.

Housing:

Material: Thermoplastic Polyester
Continuous Use Temp.: 140° C (284° F)
 (UL Index)
Flammability Rating: 94V-0
Water Absorption: .08%
Chemical Resistance: Excellent in most environments.

Breakdown Voltage:

Terminal - Terminal: 7,000V Typ.
Terminal - Ground: 6,000V Typ.

Terminals: Brass.

Standard and special pins are brass plated with high purity tin for optimum solderability. High reliability pin is a nickel-plated brass shank with gold plated beryllium copper spring.

Contact Resistance: .002 ohm Typ.

NOTE: Specifications contained herein are subject to change without notice.

HOW TO ORDER

AFT Series terminal blocks are ordered by listing designation followed by the number of poles required for the application.

Suffixes are used as follows:

W Denotes model with wire clamp (standard configuration)

C Denotes model less mounting positions (standard configuration)

Example: A 10-pole block becomes stock number AFTDWC-10. Less mounting holes.

 Recognized under the Components Program of Underwriters Laboratories, Inc. Standard 1059, Guide No. XCFR2, File No. E62557.

 Guide No. 184-N-90, Report No. LR39186-1.

DIMENSIONS

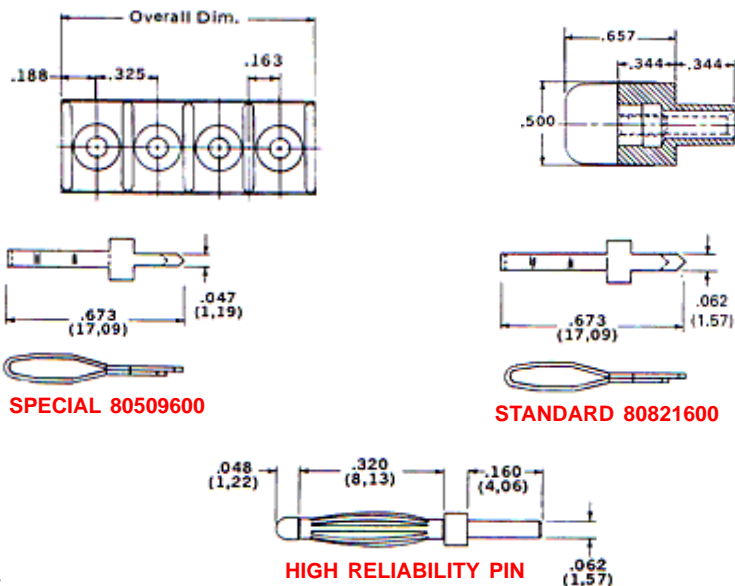

SPECIAL 80509600

STANDARD 80821600

**HIGH RELIABILITY PIN
80900010**

Note:

1. mm dim. are shown in parentheses.
2. Recommended printed circuit board hole size" 0.078" (Standard Pin).

No. of Terminals	No. of Terminals	
	Inches	Metric (mm)
1	.376	9.55
2	.701	17.81
3	1.026	26.06
4	1.351	34.32
5	1.676	42.57
6	2.001	50.83
7	2.326	59.08
8	2.651	67.34
9	2.976	75.59
10	3.301	83.85
11	3.621	92.10
12	3.951	100.36
13	4.276	108.61
14	4.601	116.87
15	4.926	125.12
16	5.251	133.38
17	5.576	141.63

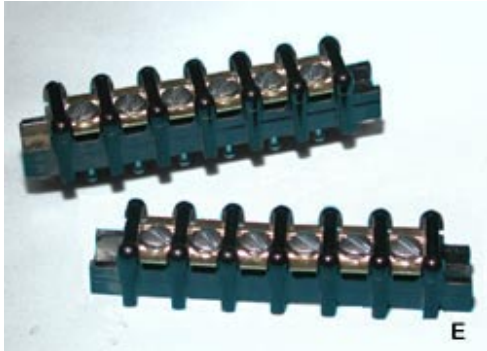

FEATURES

- **COMPACT DESIGN** – Especially suited for electronic and control and low power circuit applications up to 15 amps/300 volts.
- **FEED-THRU, PRINTED CIRCUIT OR SURFACE CONNECTION** – One thru 22 terminals on 3/8 inch center-to-center spacing.
- **BARRIER-TYPE CONSTRUCTION** – Molded of durable black thermo-set phenolic or high impact, break-resistant thermoplastic. Two .160 inch diameter integrally molded mounting holes.
- **TERMINAL FLEXIBILITY** – External terminals include two clamp designs to eliminate lugging and three quick-connect variations for up to six terminations per pole. Internal terminals include panel feed-thru, printed circuit and insulated surface mount.
- **WIRE SIZES** – No. 5-40 external terminal screws. UL recognized for No. 22AWG to No. 16AWG.
- **RECOGNITION AND LISTING** – UL recognized.
- **STANDOFFS** – EPX and EFTX are now supplied with .020 inch standoffs for ease in cleaning after soldering.



Recognized under the Components Program of Underwriters Laboratories, Inc. Standard 1059, Guide No. XCFR2, File No. E62557.

Guide No. 184-N-90, Report No. LR39186-1.

VARIATIONS



E
Closed
Back

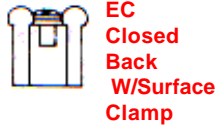

EC
Closed
Back
W/Surface
Clamp

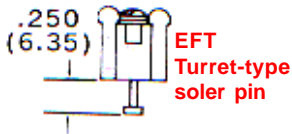

EFT
Turret-type
solder pin

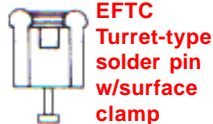

EFTC
Turret-type
solder pin
w/surface
clamp

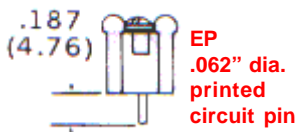

EP
.062" dia.
printed
circuit pin



EPC
.062" Dia.
printed
circuit pin
w/surface
clamp

INTERNAL TERMINAL DESIGNATIONS

- E** Closed-back design which can be mounted on metal surface with no additional insulation required.
- EP** Printed circuit board design with .062" dia. solderable tin-plated brass pin.
- EFT** Panel feed-thru design with solderable tin-plated brass turret-type solder pin.

EXTERNAL TERMINAL DESIGNATIONS

- E** Simple, efficient clamp-type terminal with No. 5-40 plated steel* screw. Accepts up to No. 16AWG wire.
- EC** Internal and surface clamp terminal with No. 5-40 plated steel* screw. Accepts up to No. 16AWG wire.
- EFT, EP** No. 5-40 plated steel* screw. Accepts up to No. 14AWG wire.
- EFTC, EPC** Surface clamp with No. 5-40 plated steel* screw. Accepts up to No. 16AWG wire.

* Other materials available – contact factory or your local representative for additional information.

ENGINEERING SPECIFICATIONS

Center-to-Center Spacing: 3/8" (9.52 mm)

Wire Range: UL recognized for No. 22AWG to No. 16AWG.

Number of Terminals: 1 thru 22

Voltage Rating: UL & CSA – 150 volts – General Industrial
250 volts – Commercial Appliance

Tightening Torque: Wire Binding Screw 9 in.-lb.
Wire Clamps 9 in.-lb.

Current Rating: 15 amps UL

Housing:

		"X" Grade
Material:	Phenolic	Polyphenylene Oxide
Continuous Use Temp.: (UL Index)	150° C (302° F)	110° C (230° F)
Flammability Rating:	94V-0	94V-0
Water Absorption: (24 hrs. % wt. gain)	.06%	.05%
Chemical Resistance:	Resistant to most organic solvents.	Resistant to inorganic bases and acids – for organic substances contact factory for specific resistance.

Breakdown Voltage:

Terminal - Terminal:	5,400V Typ.
Terminal - Ground:	7,400V Typ.

NOTE: Specifications contained herein are subject to change without notice.

PC BOARD DRILLING DIMENSIONS

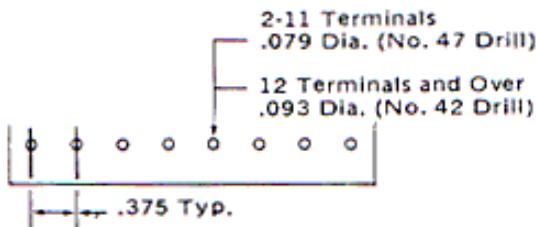

DIMENSIONS

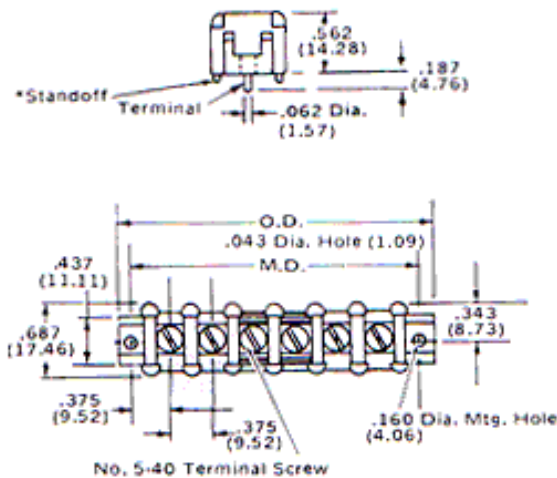

HOW TO ORDER

E Series terminal blocks are ordered by listing a composite number made up of the model designation followed by the number of poles required for the application. Example: A Type E 10-pole block becomes stock number E-10.

Suffixes are used as follows:

- R Denotes model less mounting positions
- X Denotes model with thermoplastic molding

The E-10 described above less mounting positions thus converts to stock number ER-10.

* The EPX and EFTX are made with .020" standoffs for ease in cleaning after the soldering operation.

ACCESSORIES

MARKING STRIPS

Pre-punched black fiber...mount under block. May be imprinted to customer specifications. Part No. 278A10-1 thru 26 (with mounting hole); Part No. 278A36-1 thru 26 (less mounting hole).



No. of Terminals	Mounting Dimensions		Overall Dimensions		Less Mounting Positions	
	Inches	Metric (mm)	Inches	Metric (mm)	Inches	Metric (mm)
1	.750	19.05	1.000	25.40	.562	14.28
2	1.125	28.57	1.375	34.92	.937	23.81
3	1.500	38.10	1.750	44.45	1.312	33.33
4	1.875	47.62	2.125	53.97	1.687	42.86
5	2.250	57.15	2.500	63.50	2.062	52.38
6	2.625	66.67	2.875	73.02	2.437	61.91
7	3.000	76.20	3.250	82.55	2.812	71.43
8	3.375	85.72	3.625	92.07	3.187	80.96
9	3.750	95.25	4.000	101.60	3.562	90.48
10	4.125	104.77	4.375	111.12	3.937	100.01
11	4.500	114.30	4.750	120.65	4.312	109.53
12	4.875	123.82	5.125	130.17	4.687	119.06
13	5.250	133.35	5.500	139.70	5.062	128.58
14	5.625	142.87	5.875	149.22	5.437	138.11
15	6.000	152.40	6.250	158.75	5.812	147.63
16	6.375	161.92	6.625	168.27	6.187	157.16
17	6.750	171.45	7.000	177.80	6.562	166.68
18	7.125	180.97	7.375	187.32	6.937	176.21
19	7.500	190.50	7.750	196.85	7.312	185.73
20	7.875	200.02	8.125	206.37	7.687	195.26
21	8.250	209.55	8.500	215.90	8.062	204.78
22	8.625	219.07	8.875	225.42	8.437	214.31

Dimensions shown are ±0.030".



FEATURES

- **SUPERIOR CONSTRUCTION** – All terminals are molded to place with precision screw machined brass inserts which will not twist, virtually eliminating broken joints while providing a full mechanical thread system.
- **IDEAL FOR SUB-CHASSIS OR THRU-PANEL APPLICATION** – No costly insulation or mounting set-up since feed thru insulators are an integral part of the moldings. Feature provides a full 1/4 inch terminal to ground clearance even thru 1/16 inch chassis.
- **DURABLE BASE MATERIAL** – Made of black thermo-set phenolic, or high-impact, break-resistant thermoplastic.
- **ELECTRICAL RATING** – 20 amps/up to 600 volts.
- **COMPACT BARRIER-TYPE DESIGN** – Especially suited for electronic and control applications.
- **FEED-THRU, PRINTED CIRCUIT OR SURFACE CONNECTION** – One thru 26 terminals on 7/16 inch center-to-center spacing.
- **BROAD WIRE RANGE** - UL recognized for no. 22AWG to No. 12AWG, depending on type of external contact designated with CSA requiring use of lugs on wire larger than No. 16AWG.
- **TERMINAL FLEXIBILITY** – External terminals available in three screw sizes with various internal terminal types.
- **RECOGNITION AND LISTING** – UL recognized and CSA certified.
- **METRIC SCREWS** – Available in GBPX and GFTX Series for export applications.

 Recognized under the Components Program of Underwriters Laboratories, Inc. Standard 1059, Guide No. XCFR2, File No. E62557.

 Guide No. 184-N-90, Report No. LR39186-1. COMPLIES WITH IEC 947-7-1.

VARIATIONS

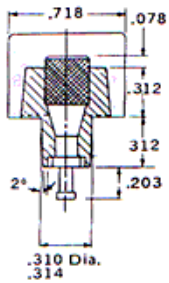

GFTX
Turret-type
solder pin

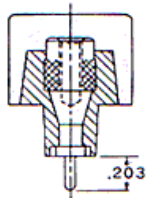

GFTPX
.062" Dia.
Printed
Circuit
Pin

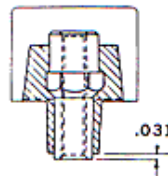

GFTSX
No.6-32
machine
screw

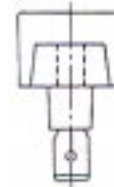

NOTE:
Consult
Factory for
Minimums

GFTZLX
.250 X
.031 QC
Terminal

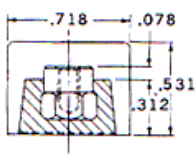

GBSX
Closed-back
design

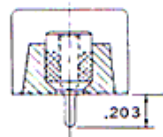

GBPX
.062" Dia.
Printed
Circuit
Pin

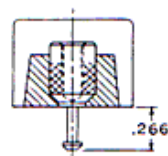

GBFTX
Turret-
Type
solder pin

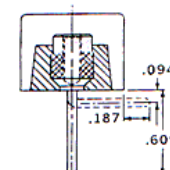

GBPNX
.062" Dia
90Degree
printed
circuit pin

NOTE: Standard bend dimension shown. Other bend dimensions are available.

ENGINEERING SPECIFICATIONS

Center-to-Center Spacing: 7/16" (11.11 mm)

Wire Range: No. 22AWG to No. 12AWG. (CSA requires use of lugs on wire larger than No. 16AWG.)

Number of Terminals: 1 thru 26

Voltage Rating: CSA – 300 volts
 UL – *150 volts – General Industrial
 **250 volts – Commercial Appliances
 300 volts – Limited Energy Applications
 600 volts – Limited Energy Applications

*GFT, GFTP, GFTS, GFTAL rated for 300 volts.

** GFTQALX rated for 125 volts.

Tightening Torque: Wire Binding Screw 9 in.-lb.
 Wire Clamp 9 in.-lb.

Current Rating: 20 amps UL and CSA.

Housing: "X" Grade

Material:	Phenolic	Polyphenylene Oxide
Continuous Use Temp.: (UL Index)	150° C (302° F)	110° C (230° F)
Flammability Rating:	94V-0	94V-0
Water Absorption: (24 hrs. % wt. gain)	.06%	.05%
Chemical Resistance:	Resistant to most organic solvents.	Resistant to inorganic bases and acids – for organic substances contact factory for specific resistance.

Breakdown Voltage:	GFT	GB
Terminal - Terminal:	3,900V Typ.	5,000 Typ.
Terminal - Ground:	5,800V Typ.	7,900 Typ.

NOTE: Specifications contained herein are subject to change without notice.

PC BOARD DRILLING DIMENSIONS

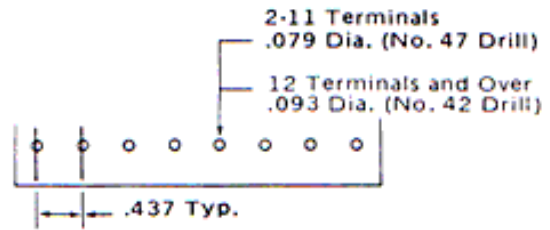

DIMENSIONS

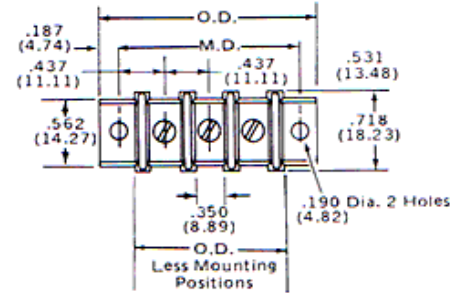

No. of Terminals	Mounting Dimensions		Overall Dimensions		Less Mounting Positions	
	Inches	Metric (mm)	Inches	Metric (mm)	Inches	Metric (mm)
1	.875	22.22	1.250	31.75	.562	14.28
2	1.312	33.33	1.687	42.86	1.000	25.40
3	1.750	44.45	2.125	53.97	1.437	36.51
4	2.187	55.56	2.562	65.08	1.875	47.62
5	2.625	66.67	3.000	76.20	2.312	58.73
6	3.062	77.78	.3437	87.31	2.750	69.85
7	3.500	88.90	3.875	98.42	3.187	80.96
8	3.937	100.01	4.312	109.53	3.625	92.07
9	4.375	111.12	4.750	120.65	4.062	103.18
10	4.812	122.23	5.187	131.76	4.500	114.30
11	6.250	133.35	5.625	142.87	4.937	125.41
12	5.687	144.46	6.062	153.98	5.375	136.52
13	6.125	155.57	6.500	165.10	5.812	147.63
14	6.562	166.68	6.937	176.21	6.250	158.75
15	7.000	177.80	7.375	187.32	6.687	169.86
16	7.437	188.91	7.812	198.43	7.125	180.97
17	7.875	200.02	8.250	209.55	7.562	192.08
18	8.312	211.13	8.687	220.66	8.000	203.20
19	8.750	222.25	9.125	231.77	8.437	214.31
20	9.187	233.36	9.562	242.88	8.875	225.42
21	9.625	244.47	10.000	254.00	9.312	236.53
22	10.062	255.58	10.437	265.11	9.750	247.65
23	10.500	266.70	10.875	276.22	10.187	258.76
24	10.937	277.81	11.312	287.33	10.625	269.87
25	11.375	288.92	11.750	298.45	11.062	280.98
26	11.812	300.03	12.187	309.56	11.500	292.10

Dimensions shown are ±0.030".

INTERNAL TERMINAL DESIGNATIONS

GFTP	Printed circuit board design with .062" dia. tin-plated brass turret-type solder pin.
GFT	Tin-plated brass turret-type solder pin.
GFTS	Unplated brass insert. No. 6-32 plated steel screw.
GBS	Unplated brass insert. Closed-back design which can be mounted on metal surface with no additional insulation required.
GBP	Printed circuit board design with .062" dia. tin plated brass pin.
GBFT	Tin-plated brass turret-type solder pin.
GFTQX	.250 x .031 tin-plated brass quick connect tab terminal.

EXTERNAL TERMINAL DESIGNATIONS

GBFT, GBP	Screw terminal with No. 6-32 plated steel* screw accepting up to No. 12AWG wire.
GBS, GFT, GFTP	
GBFTA, GBPA, GBSA, GFTA, GFTSA, GFTPA	
GFTW, GBFTW, GBPW, GFTPW, GBSW, GFTSW	Wire clamp captivated to a No. 6-32 plated steel screw accepting No. 20AWG to No. 12AWG.

* Other materials available – contact factory or your local representative for additional information.

CURTIS SERIES GFT/GB

HOW TO ORDER

GB Series terminal blocks are ordered by listing a composite number made up of the model designation followed by the number of poles required for the application. Example: Type GBP 10-pole block becomes stock number GBP-10.

Suffixes are used as follows:

- A Denotes model with No. 8-32 external screw terminal
- W Denotes model with wire clamp replacing external screw terminal
- C Denotes model less mounting positions
- X Denotes model with thermoplastic molding

To specify quick-connect terminals, simply add the style number required. May be purchased factory-assembled or as customer-installed accessory.

The GBP-10 described above – made from thermo-set phenolic – and with wire clamp, less mounting positions thus converts to stock number GBPWC-10.

ACCESSORIES

QUICK-CONNECT TERMINALS

GB/GFT – Available with .250" x .032" quick-connect tabs of tin-plated brass, held in place by terminal screws. Nine styles...one to six terminations per pole. Factory-assembled or customer-installed. Last digit of part number corresponds to previous style numbers.



Double Sided

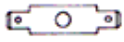

TB21



TB22



TB23

Single Sided



TB24



TB25



TB26

Double Sided



TB27

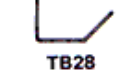

TB28



TB29

WIRE CLAMPS

GB/GFT – Wire clamp captivated to No. 6-32 screw eliminates need for lugs. Accepts to No. 12AWG wire. May be ordered by factory installed (-w suffix) or loose as Part No. 58787120.



MARKING STRIPS

GB/GFT – Pre-punched black fiber...mount under block. May be imprinted to customer specifications. To order, specify:
Part No. 267A19-1 thru 26 (with mounting hole);
Part No. 267A218-1 thru 26 (less mounting hole).



COVERS

CB/CFT – Rigid .030" thick self-extinguishing vinyl. Black matte-finished on both sides. May double as marking strip when imprinted with white ink. Complete with spring clips for attaching to mounting positions.
Part No. 267B86-1 thru 26 terminals.



TERMINAL BLOCK JUMPERS

GB/GFT – Plated brass in two styles. Type 267-A28 is designed to jump two adjacent terminals as it is channeled to cross over the barrier top. "Rooster comb" design to Type 267-A42 permits connections of two to 18 poles. To order specify:
Part No. 267-A42 (Plus no. of poles)
Example: 267-A42-18.



TINNERMAN NUT

GFT – for special mounting of terminal blocks less mounting positions. Part No. TN-437.



SERIES 71000

.629" Center-to-Center Spacing



FEATURES

- DIN rail or base mounting (panel mounting with #6 screw).
- Captive, combo head screws.
- Factory or field wiring.
- 600 volts at 85 amps.
- Blocks can be placed end-to-end while maintaining center-to-center spacing.
- .629 center-to-center spacing.
- Wire acceptance from 22AWG to 2AWG, 1AWG (7 & 19 strand only).
- No end moldings, mounting brackets or metal mounting clamps required.
- Available pre-assembled to rail or in bulk.



Recognized under the Components Program of Underwriters Laboratories, Inc. Standard 1059, Guide No. XCFR2, File No. E62557.

Guide No. 184-N-90, Report No. LR39186-1.

ENGINEERING SPECIFICATIONS

Center-to-Center Spacing: .629"

Wire Range: 1AWG (7 & 19 strand only), 2AWG to 22AWG

Number of Terminals: 6 (contact factory for other lengths)

Voltage Rating: 600 volts

Tightening Torque:

1AWG thru 4AWG	35 in.-lb. max
6 AWG thru 14 AWG	30 in.-lb. max
16AWG thru 22AWG	25 in.-lb. max

Current Rating: 85 amps – Copper Wire

50 amps – Aluminum Wire

Housing:

Material:	Reinforced PBT Polyester
Continuous Use Temp.: (UL Index)	140° C
Flammability Rating:	94V-0
Water Absorption: (24 hrs. % wt. gain)	.07%
Chemical Resistance:	Excellent in most environments

Breakdown Voltage:

Terminal - Terminal:	7,500V Typ.
Terminal - Ground:	7,000V Typ.

NOTE: Specifications contained herein are subject to change without notice.

DIMENSIONS

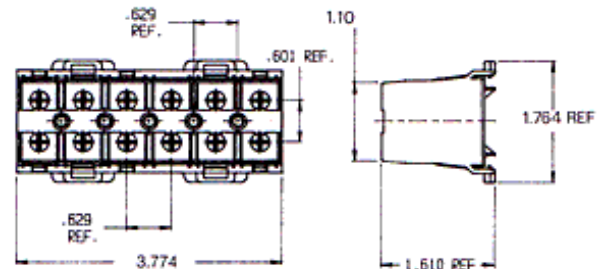

HOW TO ORDER

71 0 2 X 000

Standard
001 thru 999 and 00A thru ZZZ -
to be assigned by factory to
designate special options

1 thru 6
No of active poles

Consult factory for blocks pre-assembled to track.

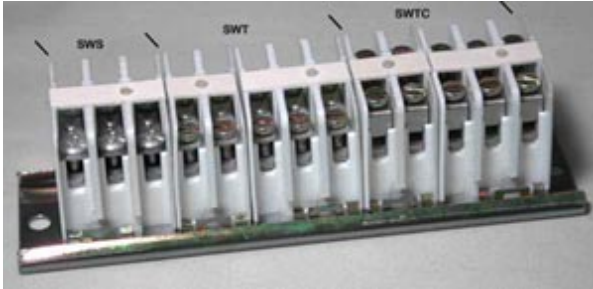

FEATURES

- **SNAP-IN TRACK-TYPE CONCEPT** – To assemble two or three-pole modules simultaneously, simply insert one edge of the module under the flange of the track (over for DIN modules) and with very little pressure snap into place. To remove, push center section of spring toward molding. Module will “pop free.”
- **“D” SERIES MADE TO MOUNT ON DIN TRACK.**
- **TOTAL MODULE PRINCIPLE** – Two and three-pole nylon modules are complete with white fiber marking strips and retaining springs.
- **REDUCED INVENTORY** – No end moldings, mounting brackets or metal mounting clamps are needed for assembly.
- **COMPACT DESIGN** – 3/8" center-to-center terminals provide compact circuit density. 32 poles per foot - 192 per six foot length.
- **TERMINAL FLEXIBILITY** – Three different terminal variations are available. Ratings up to 50 amps/600 volts.
- **DURABLE MODULAR CONSTRUCTION** – All SW and DSW models feature moldings of break-resistant nylon.
- **MAY BE PRE-ASSEMBLED ON TRACK.**
- **WIRE SIZES** – Types SWS and DSWS strap screw terminal with No. 6-32 screws. UL recognized for No. 22AWG to No. 14AWG. Types SWT and DSWT tubular terminal with No. 10-32 screws. UL recognized for No. 16AWG to No 8AWG. Types SWTC and dSWTC tubular clamp terminal with No. 10-32 screws. UL recognized for No. 22AWG to No. 8AWG.
- **RECOGNITION AND LISTING** – UL recognized and CSA certified.



Recognized under the Components Program of Underwriters Laboratories, Inc. Standard 1059, Guide No. XCFR2, File No. E62557.

Guide No. 184-N-90, Report No. LR39186-1.

VARIATIONS AND TERMINAL DESIGNATIONS

SWS & DSWS

Brass terminal bars with No. 6-32 terminal screws. Accepts wire up to No. 14AWG. Requires the use of lugs.



SWT & DSWT

Solderless electro-tinned tubular connector with No. 10-32 terminal screws. Accepts wire from No. 16AWG to No. 8AWG.



SWTC & DSWTC

Solderless electro-tinned tubular connector with No. 10-32 terminal screws captivated by traveling pressure pad. Accepts wire from No. 22AWG to No. 8AWG.



NOTE: All variations as illustrated above available in two or three terminal modules only.

ENGINEERING SPECIFICATIONS

Center-to-Center Spacing: 3/8" (9.52 mm)

Wire Range: SWS and DSWA-No 22AWG to No. 14AWG (Above requires use of lugs.)

SWT and DSWT - No. 16AWG to No. 8AWG.

SWTC and DSWTC - No. 22AWG to No. 8AWG.

Number of Terminals: 2 thru 192

Voltage Rating: CSA and UL - 600 volts.

Tightening Torque:

Type SWS and DSWS 12 in.-lb.

Type SWT and DSWT 25 in.-lb.

Type SWTC and DSWTC 25 in.-lb.

Current Rating: SWS and DSWS - 25 amps; SWT, DSWT, SWTC and DSWTC - 50 amps.

Housing:

Material: Polyamide

Continuous Use Temp.: 125° C (257° F)
(UL Index)

Flammability Rating: 94V-2

Water Absorption:
(24 hrs. % wt. gain) 1.5%

Chemical Resistance: Outstanding resistance to both.

Breakdown Voltage: SWS/DSWS SWT/DSWT SWTC/DSWTC

Terminal - Terminal: 7,500V Typ. 4,700V Typ. 4,900V Typ.

Terminal - Ground: 7,000V Typ. 8,200V Typ. 9,300V Typ.

NOTE: Specifications contained herein are subject to change without notice.

HOW TO ORDER

SW and DSW Series modules are ordered by listing a composite number made up of the model designation preceded by the number of poles per module.

Prefixes are uses as follows:

2P Denotes 2-pole module

3P Denotes 3-pole module

Example: a two-pole SWT module becomes stock number 2PSWT; a three-pole module becomes 3PSWT. A two-pole DSWT module becomes stock number 2PDSWT; a three-pole module becomes 3PDSWT.

See pages 24 & 25 for higher current blocks which may be combined with the SW and DSW series.

See pages 26 & 27 for track, pre-assembled blocks and accessory modules.

DIMENSIONS

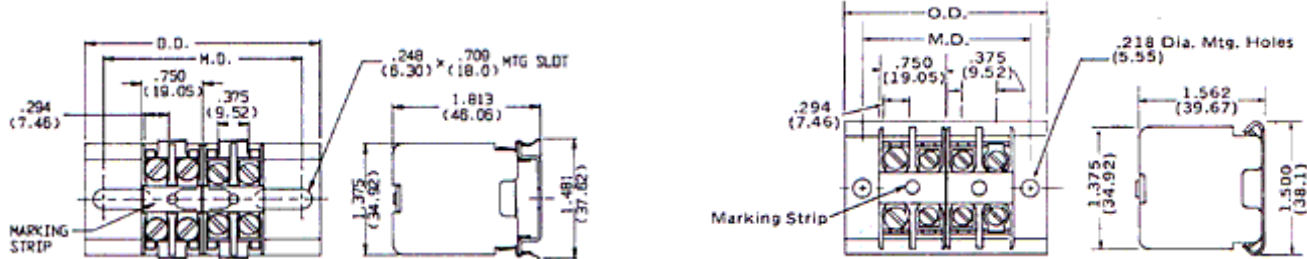

Call factory for mounting dimensions on other lengths.

ACCESSORIES

White fiber marking strip available in two or three-pole lengths or in pre-punched 100-ft. rolls.

To order specify:
Part No. 275A8 (2PSW, 2PDSW)
Part No. 275A9 (3PSW, 3PDSW)
100-ft Rolls - Part No. 20SW
Pins - Part No. 21SW



Insulated phosphor-bronze connector clamps to over head of No. 10-32 terminal screws. Test lead and test jumper are constructed from 6' length of No. 14AWG wire. Test lead is fitted with connector at one end only, while test jumper has connectors at both ends. Connectors eliminate use of alligator clips and are rated 50 amps intermittently at 15 amps continuously.
18W (test lead)
19W (test jumper)



Brass jumper connects 12 consecutive terminals and can be cut for shorter applications.

Part No. 275-A14.



Type 275-A16 is designed to connect two adjacent terminals.

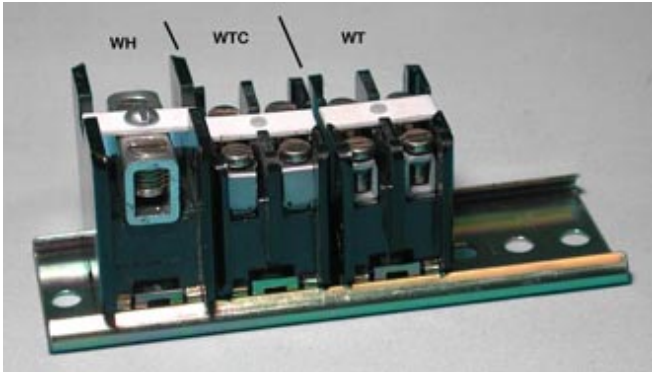

FEATURES

- **SNAP-IN TRACK-TYPE CONCEPT** – To assemble two or three-pole modules simultaneously, simply insert one edge of the module under the flange of the track (over for DIN modules) and with very little pressure snap into place. To remove, push center section of spring toward molding. Module will “pop free.”
- **“D” SERIES MADE TO MOUNT ON DIN TRACK.**
- **TOTAL MODULE PRINCIPLE** – Two and three-pole nylon modules are complete with white fiber marking strips and retaining springs.
- **REDUCED INVENTORY** – No end moldings, mounting brackets or metal mounting clamps are needed for assembly.
- **COMPACT DESIGN** – 7/16" center-to-center terminals provide compact circuit density. 164 poles per six foot length.
- **TERMINAL FLEXIBILITY** – Different terminal variations are available. Ratings up to 75 amps/600 volts.
- **DURABLE MODULAR CONSTRUCTION** – All W and DW models feature rugged thermo-set phenolic moldings.
- **MAY BE PRE-ASSEMBLED ON TRACK.**
- **WIRE SIZES** – Types WT and DWT with No. 10-32 tubular terminal screws UL recognized for No. 16AWG to No. 8AWG. Types WTC and DWTC tubular clamp terminal with No. 10-32 screws UL recognized for No. 22AWG to No. 8AWG. Types WH and DWH with 5/16-24 terminal screws UL recognized for No. 22AWG to No. 4AWG.
- **RECOGNITION AND LISTING** – UL recognized and CSA certified.



Recognized under the Components Program of Underwriters Laboratories, Inc. Standard 1059, Guide No. XCFR2, File No. E62557.



Guide No. 184-N-90, Report No. LR39186-1.

VARIATIONS AND TERMINAL DESIGNATIONS

WT & DWT



Solderless electro-tinned tubular connector with No. 10-32 terminal screws. Accepts wire from No. 16AWG to No. 8AWG. Rated 50 amps/600 volts.

NOTE: All variations as illustrated above available in two or three terminal modules only, except “WH” and “DWH” types which are single terminal modules.

WTC & DWTC



Solderless electro-tinned tubular connector with No. 10-32 terminal screws captivated by traveling pressure pad. Accepts wire from No. 22AWG to No. 8AWG. Rated 50 amps/600 volts.

WH & DWH



Solderless electro-tinned tubular connector with sidewall tapped for 5/16"-24" terminal screw. Accepts wire from No. 22AWG to No. 4AWG. Rated 75 amps/600 volts.

See Page 27 for Special Purpose Blocks which may be combined with W and DW types.
See Page 27 for Pre-Assembled Blocks.
See Page 26 for Track Information.

ENGINEERING SPECIFICATIONS

Center-to-Center Spacing: 7/16" (11.11 mm)

Wire Range: WT and dWT-No. 16AWG to No. 8AWG
 WTC and DWTC - o. 22AWG to No. 8AWG
 WH and DWH - No. 22AWG to No. 4AWG.

Number of Terminals: 2 thru 164

Voltage Rating: 600 volts. CSA and UL

Tightening Torque:

WT, DWT, WTC, DWTC 25 in.-lb.
 WH and DWH 45 in.-lb. (4-6AWG)
 40 in.-lb. (8AWG)
 35 in.-lb. (10-14AWG)

Current Rating: WT, DWT, WTC and DWTC - 50 amps; WH and DWH - 75 amps.

Housing:

Material: Phenolic
 Continuous Use Temp.: 150° C (302° F)
 (UL Index)
 Flammability Rating: 94V-1
 Water Absorption:
 (24 hrs. % wt. gain) 0.5%
 Chemical Resistance: Resistant to most organic solvents.

Breakdown Voltage:	WT/DWT	WTC/DWTC	WH/DWH
Terminal - Terminal:	6,300V Typ.	5,100V Typ.	10,500V Typ.
Terminal - Ground:	10,100V Typ.	10,100V Typ.	7,700V Typ.

NOTE: Specifications contained herein are subject to change without notice.

DIMENSIONS

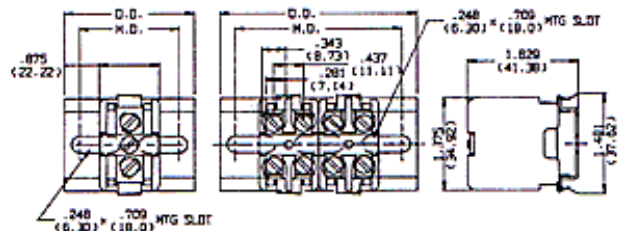
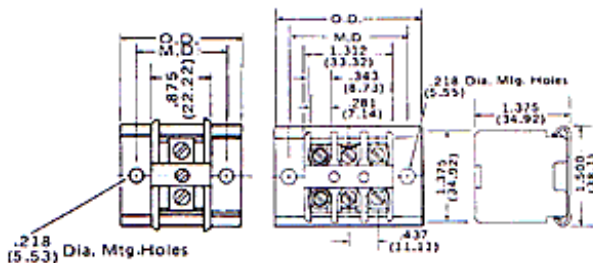

Call factory for mounting dimensions on other lengths.

ACCESSORIES



White fiber marking strip available in two or three-pole lengths or in pre-punched 100-ft. rolls.

To order, specify:

Part No. 271A11 (2PW, 2PDW)

Part No. 271A13 (3PW, 3PDW)

Part No. 271A13 (3PW, 3PDW)

100-ft Rolls - Part No. 20W

Pins - Part No. 21W



Insulated phosphor-bronze connector clamps to over head of No. 10-32 terminal screws. Test lead and test jumper are constructed from 6' length of No. 14AWG wire. Test lead is fitted with connector at one end only, while test jumper has connectors at both ends. Connectors eliminate use of alligator clips and are rated 50 amps intermittently at 15 amps continuously.
 18W (test lead)
 19W (test jumper)



Brass jumper connects 12 consecutive terminals and can be cut for shorter applications. Part No. 271-A72.

Type 275-A16 is designed to connect two adjacent terminals of WT, DWT, WTC and DWTC assemblies. Part No. 275-A16.



Black rubber cover (2-pole only)...unique molded-hinge design virtually eliminates shorting or shock as a result of contact with "live" terminals. Cover attached by No. 4 x 1/2" thread cutting screw with white fiber marking strip mounted beneath screw head. Cover offers same 300° F temperature limit as base molding. Available bulk (cover, marking strip and screw) for customer-installed applications or on factory-assembled W and DW Series blocks and modules. To order bulk package, specify: Part No. 17W.

SPECIAL & PRE-ASSEMBLED BLOCKS

FUSE MODULES

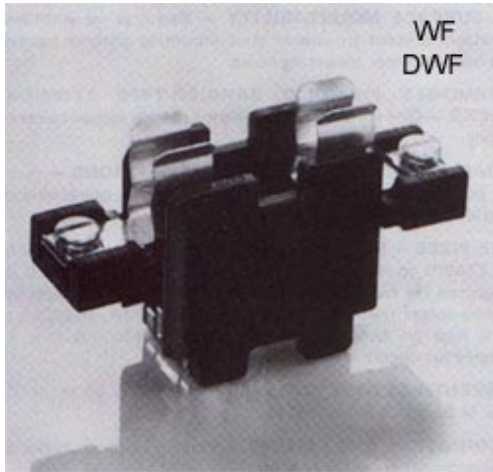

Curtis special purpose modules mount in the same track and are utilized in conjunction with the W/SW and DW/DSW type terminal blocks. Provides the user easy mounting and accessibility of these devices.

TERMINAL DESIGNATIONS

WF Fuse-holder accepting any 13/32" x 1-1/2" ferrule-type cartridge fuse. Has brass terminal bars with No. 8-32 washerhead terminal screws. Fuse-clips are silver-plated beryllium copper Rated 15 amps/250 volts.

WGF Fuse-holder accepting any 1/4" x 1-1/4" glass or ceramic cartridge fuse. Brass terminals with No. 6-32 wire binding screw. Rated 15 amps/250 volts.

WIF Fuse-holder accepting any 13/32" x 1-1/2" ferrule-type cartridge fuse. Brass terminal bars with 3-piece sems wire clamp assembly eliminates lugs. Fuse-clips are tin-plated beryllium copper. Rated 15 amps/600 volts. (Includes fuse puller.)

WF, DWF, WIF and DWIF units are furnished complete with puller/cover.



Models WF, DWF, WIF and DWIF are recognized under the Components program of Underwriters Laboratories, Inc. under File No. E72544 and listed by Canadian Standards Association under Report No. LR39186.

Note: mm dimensions are shown in parentheses.

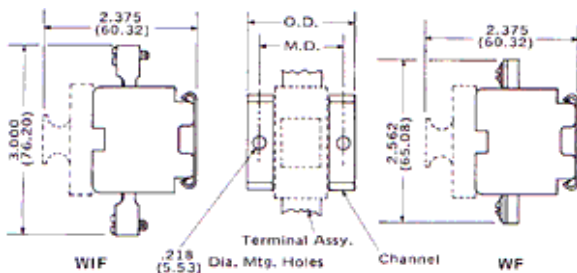

Note: mm dimensions are shown in parentheses.

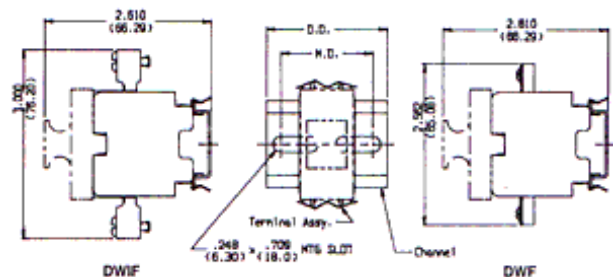

To order single-pole modules, specify PWF, DPWF, PWIF or DPWIF. See page 26 for track information.

PRE-ASSEMBLED TERMINALS and FUSE BLOCKS

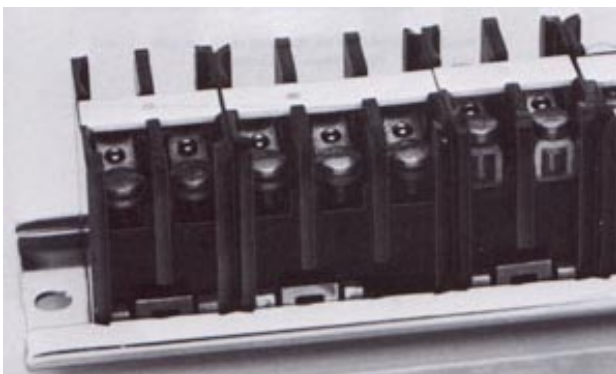

FEATURES

- **REDUCED ASSEMBLY COSTS** – designed for large volume work where identical assemblies are used. Mounting track pre-punched on 3/8 inch (SW series) or 7/16 inch (W Series) center-to-center spacing eliminates need to drill mounting holes. DIN mounting holes are slots on .984" center-to-center spacing.
- **BROAD SIZE SELECTION** – available in any size up to 192 poles (SW) or 164 (W). Furnished with exact number of poles specified, complete with zinc-dichromate plated steel track.
- **COST-SAVING THREE AND SIX-FOOT LENGTHS** – available in these standard lengths, factory assembled blocks can be used in full length or cut to size needed. Cutting to specific lengths requires no additional parts (end molding or clamps) to finish off block. DIN track available in two meter (78.74") lengths.

HOW TO ORDER

When ordering to specific size, simply designate model and number of poles. Example: SWT with 6-poles becomes stock number SWT-6.

When ordering standard three foot lengths, simply designate model followed by 96 (SW Series) or 82 (W); for six foot lengths, 192 (SW)O or 164 (W). Examples: SWT-192 or WT-164 (six foot); SWT-96 or WT-82 (three-foot).

NOTE: Various terminal types and units mounted to DIN rail are available. Consult factory or your local representative for further information.



FEATURES

- **COMPACT MODULAR DESIGN FOR LOW POWER CIRCUITS** – Suitable for surface connection applications using channel-assembled modular construction.
- **ALL-SURFACE MOUNTABILITY** – Requires no additional insulation. Electro tin-coated steel mounting channel has two .196 inch diameter mounting holes.
- **THERMO-SET PHENOLIC BARRIER-TYPE TERMINAL BLOCKS** – One thru 24 terminals on 1/2 inch center-to-center spacing.
- **BROAD CHOICE OF TERMINAL CONNECTIONS** – Available in three screw designs and two .250" wide quick-connect variations offering up to four connections per terminal.
- **WIRE SIZES** – M Series (No. 6-32 screw) is UL recognized for No. 22AWG to No. 14AWG. MA Series (No. 8-32 screw) is UL recognized for No. 22AWG to No. 12AWG. CSA requires lugs on wire larger than No. 14AWG for Series MA and CSA requires lugs on No. 16AWG for Series M. Marking tabs are available for circuit identification.
- **CURRENT/VOLTAGE RATING** – MA Series 25 amps/300 volts, M Series 15 amps/300 volts.
- **CURRENT/VOLTAGE RATING** – MA Series 25 amps/300 vols, M Series 15 amps/300 volts.
- **RECOGNITION AND LISTING** – Various terminal types are UL recognized and CSA certified.



Recognized under the Components Program of Underwriters Laboratories, Inc. Standard 1059, Guide No. XCFR2, File No. E62557.

Guide No. 184-N-90, Report No. LR39186-1.

VARIATIONS



MA
Terminal bar
with two
No. 8-32
screws



MAQ
Four .250"
wide quick-
connects



MALQ
Two .250"
wide quick-
connects
and one No.
8-32 screw



M
Terminal bar
with two No.
6-32 screws



MC
Terminal Bar
with two
captivated
clamp
assemblies

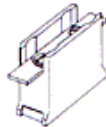

M Type
With marking
strip
attached
(see below)*

TERMINAL DESIGNATIONS

- *MA 16-gauge (.051") brass terminal bar with two NO. 8-32 plated steel screws per terminal accepting wire up to No. 12AWG.
- *MAQ Four .250" x .032" brass quick-connect tabs per terminal accepting wire up to No. 12AWG.
- *MALQ Two .250" x .032" brass quick-connect tabs and one No. 8-32 plated steel screw per terminal accepting wire up to No. 12AWG. Rated 25 amps/300 volts.
- *M Brass terminal bar with two No. 6-32 plated steel screws per terminal accepting wire up to No. 14AWG.
- *MC Brass terminal bar with two-piece No. 6-32 plated steel, captivated clamp assemblies per terminal accepting wire up to No. 14AWG.

*All models available with marking tabs. To specify, add the suffix "T". (See "How to Order").

ACCESSORIES

Plain cover of 1/16" thick black bakelite with two mounting studs. Supplied loose for customer installation.

Part No. 256A93-1 thru 24 terminals.

Brass Jumper rated at 25 amps.

Part No. 258-A5.



ENGINEERING SPECIFICATIONS

Center-to-Center Spacing: 1/2" (12.7 mm)

Wire Range: UL Recognized for No. 22AWG to No. 12AWG (MA), WNo. 22AWG to No. 14AWG (M), (CSA requires use of lugs on wire larger than NO. 14AWG (Ma), No. 16AWG (M).)

Number of Terminals: 1 thru 24

Voltage Rating: CSA – 300 volts
UL – 150 volts – General Industrial
250 volts – Commercial Appliance

Tightening Torque: 12 in.-lb.

Current Rating: 15 amps (M); 25 amps (Ma). UL and CSA.

Housing:

Material: Phenolic
Continuous Use Temp.: 150° C (302° F)
(UL Index)
Flammability Rating: 94V-1
Water Absorption:
(24 hrs. % wt. gain) 0.5%
Chemical Resistance: Resistant to most organic solvents.

Breakdown Voltage:

Terminal - Terminal: 7,400V Typ.
Terminal - Ground: 7,800V Typ.

NOTE: Specifications contained herein are subject to change without notice.

HOW TO ORDER

M Series terminal blocks are ordered by listing a composite number made up of the model designation followed by the number of poles required for the application. Example: Type M 10-pole block becomes stock number M-10.

Suffixes are uses as follows:

T Denotes model where marking tabs are required.

The M-10 described above with marking tabs thus converts to stock number MT-10.

DIMENSIONS

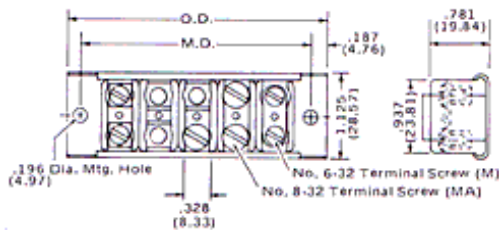

No. of Terminals	Mounting Dimensions		Overall Dimensions	
	Inches	Metric (mm)	Inches	Metric (mm)
1	1.000	25.40	1.375	34.92
2	1.500	38.10	1.875	47.62
3	2.000	50.80	2.375	60.32
4	2.500	63.50	2.875	73.02
5	3.000	76.20	3.375	85.72
6	3.500	88.90	3.875	98.42
7	4.000	101.60	4.375	111.12
8	4.500	114.30	4.875	123.82
9	5.000	127.00	5.387	136.52
10	5.500	139.70	5.875	149.22
11	6.000	152.40	6.375	161.92
12	6.500	165.10	6.875	174.62
13	7.000	177.80	7.375	187.32
14	7.500	190.50	7.875	200.02
15	8.000	203.20	8.375	212.72
16	8.500	215.90	8.875	225.42
17	9.000	228.60	9.375	238.12
18	9.500	241.30	9.875	250.82
19	10.000	254.00	10.75	263.52
20	10.500	266.70	10.875	276.22
21	11.000	279.40	11.375	288.92
22	11.500	292.10	11.875	301.62
23	12.000	304.80	12.375	314.32
24	12.500	317.50	12.875	327.02

Dimensions shown are ±0.030".



FEATURES

- **VERSATILE MEDIUM POWER TERMINAL BLOCKS** – Designed for surface mount; power and control applications requiring a wide range of terminal variations.
- **SECTIONAL THRU-BOLT CONSTRUCTION** – Available in one thru 0 terminals on 35/64 inch center-to-center spacing. Rated 30 amps/600 volts for Type CDM; 20 amps/600 volts for Type CT.
- **DURABLE BREAK-RESISTANT THERMOPLASTIC MOLDINGS.**
- **WIRE SIZES** – Type CT has brass terminal bar with two three-piece plated steel wire clamp assemblies UL recognized for No. 22AWG to No. 12AWG. Type CDM features brass terminal bar with two No. 10-32 washer-head screws. UL recognized for No. 22AWG to No. 10AWG.
- **EASY CIRCUIT IDENTIFICATION DESIGN** – Barrier-type terminals are furnished with a white fiber marking strip.
- **RECOGNITION AND LISTING** – Various terminal types are UL recognized and CSA certified.



Recognized under the Components Program of Underwriters Laboratories, Inc. Standard 1059, Guide No. XCFR2, File No. E62557.



Guide No. 184-N-90, Report No. LR39186-1.

VARIATIONS



TERMINAL DESIGNATIONS

- | | |
|-----|--|
| CDM | Brass terminal bar with two No. 10-32 washer-head screws accepting wire up to No. 10AWG. Rated 30 amps. |
| CT | Brass terminal bar with two three-piece plated steel wire clamp assemblies accepting wire up to No. 12AWG. |

ACCESSORIES

CDM/CT – Two cover styles. Hinged cover of 3/16" thick black bakelite pivoting from special end brackets provide ready access to block. Factory-assembled and available only with original terminal block order. Plain cover of 1/16" thick black bakelite is permanently positioned to block with two screws. Factory-assembled or customer-installed. To order, specify:

- CDM/CT (Plain) – Part No. 265A61-1 thru 50 terminals
- CDM (Hinged) – Part No. 265A67-1 thru 50 terminals
- CT (Hinged) – Part No. 265A68-1 thru 50 terminals

CDM – Copper jumper rated 30 amps. Designed to fold over barrier to connect adjacent terminals. To order, specify Part No. 523-A91.

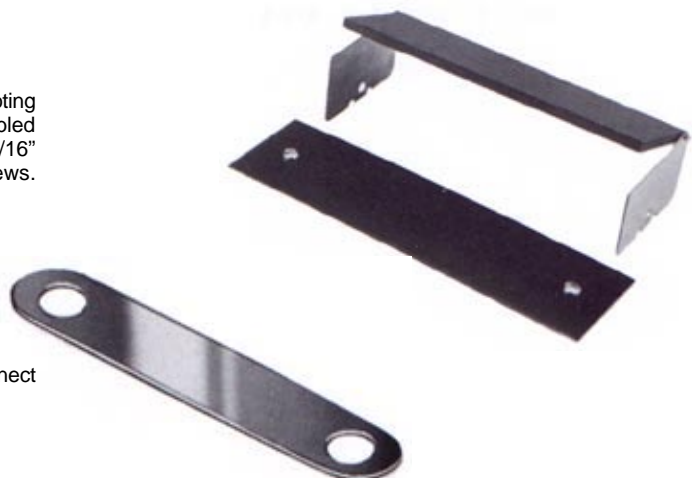

35/64" (13.86 mm) Center-to-Center Spacing

ENGINEERING SPECIFICATIONS

Center-to-Center Spacing: 35/64" (13.86 mm)

Wire Range: Type CDM Type CT
 UL Recognized for UL Recognized for
 22AWG to No. 10AWG 22AWG to No. 12AWG

Number of Terminals: 1 thru 50

Voltage Rating: CSA and UL – 600 volts.

Tightening Torque: 35 in.-lb.

Current Rating: 30 amps/CDM; 20 amps/CT. UL and CSA.

Housing:

Material: Thermoplastic-polyester
 Continuous Use Temp.: 130° C (266° F)
 (UL Index)
 Flammability Rating: 94V-0
 Water Absorption:
 (24 hrs. % wt. gain) 0.7%
 Chemical Resistance: Excellent in most environments.

Breakdown Voltage: **CDM** **CT**
 Terminal - Terminal: 9,600V Typ. 9,400V Typ.
 Terminal - Ground: 10,500V Typ. 10,500V Typ.

NOTE: Specifications contained herein are subject to change without notice.

HOW TO ORDER

Type CDM and CT terminal blocks are ordered by listing a composite number made up of the model designation followed by the number of poles required for the application. Example: 10-pole terminal block becomes stock number CDM-10 or CT-10.

DIMENSIONS

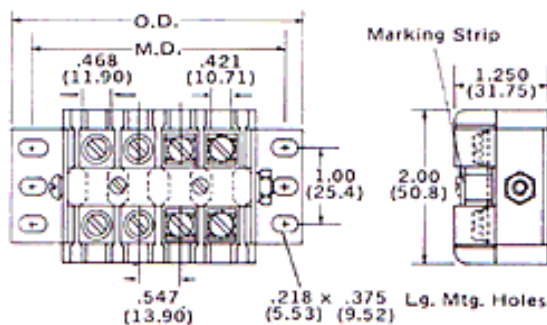

No. of Terminals	Mounting Dimensions		Overall Dimensions	
	Inches	Metric (mm)	Inches	Metric (mm)
1	1.672	42.48	2.346	59.59
2	2.220	56.38	2.896	73.56
3	2.767	70.28	3.441	87.40
4	3.314	84.18	3.988	101.30
5	3.861	98.08	4.535	115.19
6	4.409	111.98	5.083	129.11
7	4.956	125.88	5.630	143.00
8	5.503	139.78	6.177	156.90
9	6.050	153.68	6.724	170.79
10	6.598	167.58	7.272	184.71
11	7.145	181.48	7.819	198.60
12	7.692	195.38	8.366	212.50
13	8.239	209.28	8.913	226.39
14	8.787	223.18	9.461	240.31
15	9.334	237.08	10.008	254.20
16	9.881	250.98	10.555	268.10
17	10.428	264.88	11.102	281.99

No. of Terminals	Mounting Dimensions		Overall Dimensions	
	Inches	Metric (mm)	Inches	Metric (mm)
18	10.976	278.78	11.650	295.91
19	11.523	292.68	12.197	309.80
20	12.070	306.58	12.744	323.70
21	12.617	320.48	13.291	337.59
22	13.165	334.38	13.839	351.51
23	13.712	348.28	14.386	365.40
24	14.259	362.18	14.933	379.30
25	14.806	376.08	15.480	393.19
26	15.354	389.98	16.028	407.11
27	15.901	403.88	16.575	421.01
28	16.448	417.78	17.122	434.90
29	16.995	431.68	17.669	448.79
30	17.543	445.58	18.217	462.71
31	18.090	459.48	18.764	476.61
32	18.637	473.38	19.311	490.50
33	19.184	487.28	19.858	504.39
34	19.732	501.18	20.406	518.31

No. of Terminals	Mounting Dimensions		Overall Dimensions	
	Inches	Metric (mm)	Inches	Metric (mm)
35	20.279	515.08	20.953	532.21
36	20.826	528.98	21.500	546.10
37	21.373	542.88	22.047	559.99
38	21.921	556.78	22.595	573.91
39	22.468	570.68	23.142	587.81
40	23.015	584.58	23.689	601.70
41	23.562	598.48	24.236	615.59
42	24.110	612.38	24.784	629.51
43	24.657	626.28	25.331	643.41
44	25.204	640.18	25.878	657.30
45	25.751	654.08	26.425	671.20
46	26.299	667.98	26.973	685.11
47	26.846	681.88	27.520	699.01
48	27.393	695.78	28.067	712.90
49	27.940	709.68	28.614	726.80
50	28.488	723.58	29.162	740.71

Dimensions shown are ±0.030".

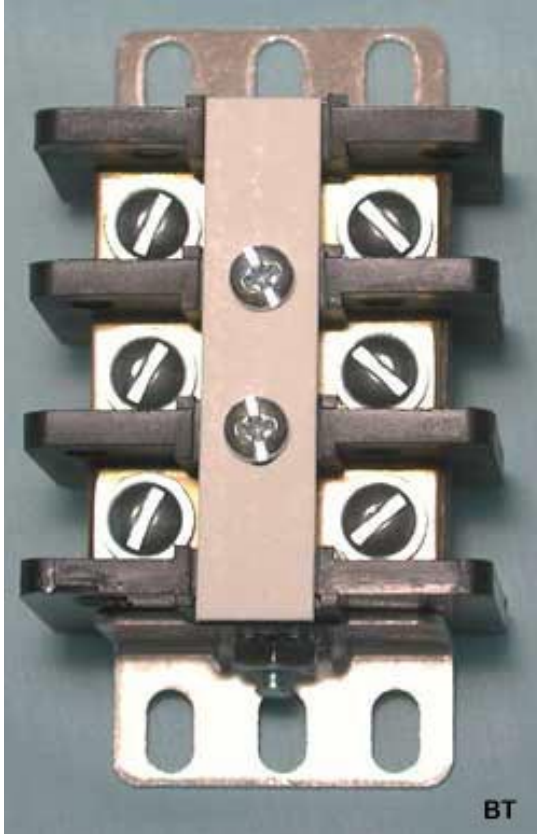

FEATURES

- **SECTIONAL, HIGH AND MEDIUM POWER TERMINAL BLOCKS** – Designed for high power applications and control/power circuits respectively. Units approach power ratings of larger terminal blocks while retaining increased circuit density of low power designs.
- **BROAD TERMINAL CHOICE** – one thru 30 terminals are .652 inch center-to-center spacing with white fiber circuit marking strips.
- **THRU-BOLT BARRIER-TYPE CONSTRUCTION** – Rated at 75 amps/600 volts for Type H; 30 amps/600 volts for Type BT.
- **UNIQUE BAR AND TRAVELING COLLAR DESIGN** – Eliminates lugging of wire on Type H. UL recognized for No. 16AWG to No. 4AWG. Type BT uses two No. 10-32 terminal screws, UL recognized for No. 22AWG to No. 10AWG.
- **COMBINED STYLE FLEXIBILITY** – Types can be used in combination as well as be combined with types L, O, S, T & U for greater application flexibility.
- **RECOGNITION AND LISTING** – UL recognized and CSA certified.



Recognized under the Components Program of Underwriters Laboratories, Inc. Standard 1059, Guide No. XCFR2, File No. E62557.

Guide No. 184-N-90, Report No. LR39186-1.

VARIATIONS



H
High-pressure solderless connector



BT
Terminal bar with two No. 10-32 screws

TERMINAL DESIGNATIONS

- H** Brass bar with high-pressure solderless connectors accepting wire from No. 16AWG to No. 4AWG.
- BT** Brass terminal bar with two No. 10-32 plated steel terminal screws accepting wire up to No. 10AWG.

ACCESSORIES

H/BT – Two cover styles. Hinged cover of 3/16" thick black bakelite pivoting from special end brackets provide ready access to block. Factory-assembled and available only with original terminal block order. Plain cover of 1/16" thick black bakelite is permanently positioned to block with two screws. Factory-assembled or customer-installed. To order, specify:

- H/BT (Plain) – Part No. 260A49-1 thru 30 terminals
H (Hinged) – Part No. 260A56-1 thru 30 terminals
BT (Hinged) – Part No. 260A122-1 thru 30 terminals



ENGINEERING SPECIFICATIONS

Center-to-Center Spacing: .652" (16.56 mm)

Wire Range: Type H Type BT
 UL Recognized for UL Recognized for
 No. 16AWG to No. 22AWG to
 No. 4AWG. No. 10AWG.

Number of Terminals: 1 thru 30

Voltage Rating: CSA and UL – 600 volts.

Tightening Torque:

Type H – 45 in.-lbs. (4-6AWG)
 40 in.-lbs. (8AWG)
 35 in.-lbs. (10-16AWG)
 Type BT 20 in.-lbs.

Current Rating: 75 amps (Type H); 30 amps BT. UL and CSA.

Housing:

Material: Thermoplastic-polyester
 Continuous Use Temp.: 130° C (266° F)
 (UL Index)
 Flammability Rating: 94V-0
 Water Absorption: (24 hrs. % wt. gain) 0.7%
 Chemical Resistance: Excellent in most environments.

Breakdown Voltage: CDM CT

Terminal - Terminal: 10,400V Typ. 8,100V Typ.
 Terminal - Ground: 8,400V Typ. 7,600V Typ.

NOTE: Specifications contained herein are subject to change without notice.

HOW TO ORDER

Types H and BT terminal blocks are ordered by listing a composite number made up of the model designation followed by the number of terminals required for the application. Example: 10-pole terminal block becomes H-10 or BT-10.

When ordering combinations of both types, the composite number is made up of both model designations followed by total number of poles and number of each type. A composite of three H terminals followed by two BT terminals thus is converted to stock number HBT-5 (3H, 2BT).

Combining these types with types L, O, S, T and U would follow the same ordering format. (Note: when combined with types T, UI, L, O and S, a special adapter is required.)

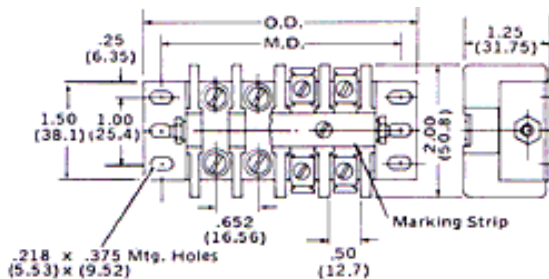

No. of Terminals	Mounting Dimensions		Overall Dimensions	
	Inches	Metric (mm)	Inches	Metric (mm)
1	1.66	42.1	2.36	59.8
2	2.31	58.6	3.01	76.4
3	2.96	75.1	3.66	92.9
4	3.61	91.6	4.31	109.4
5	4.26	108.1	4.96	126.0
6	4.91	124.6	5.61	142.5
7	5.56	141.1	6.26	159.1
8	6.21	157.6	6.92	175.6
9	6.86	174.1	7.57	192.2
10	7.51	190.6	8.22	208.7
11	8.16	207.1	8.87	225.3
12	8.81	223.6	9.52	241.8
13	9.46	240.2	10.17	258.4
14	10.10	256.6	10.82	274.9
15	10.75	273.2	11.48	291.5
16	11.40	289.7	12.13	308.0
17	12.05	306.2	12.78	324.6
18	12.70	322.7	13.43	341.1
19	13.35	339.2	14.08	357.7
20	14.00	355.7	14.73	374.2
21	14.65	372.2	15.39	390.8
22	15.30	388.7	16.04	407.3
23	15.95	405.2	16.69	423.9
24	16.60	421.7	17.34	440.4
25	17.25	438.2	17.99	457.0
26	17.90	454.7	18.64	473.5
27	18.55	471.2	19.29	490.1
28	19.20	487.7	19.95	506.6
29	19.85	504.2	20.60	523.2
30	20.50	520.7	21.25	539.7

Dimensions shown are ±0.030".

CURTIS TYPES L, O, S, T and U

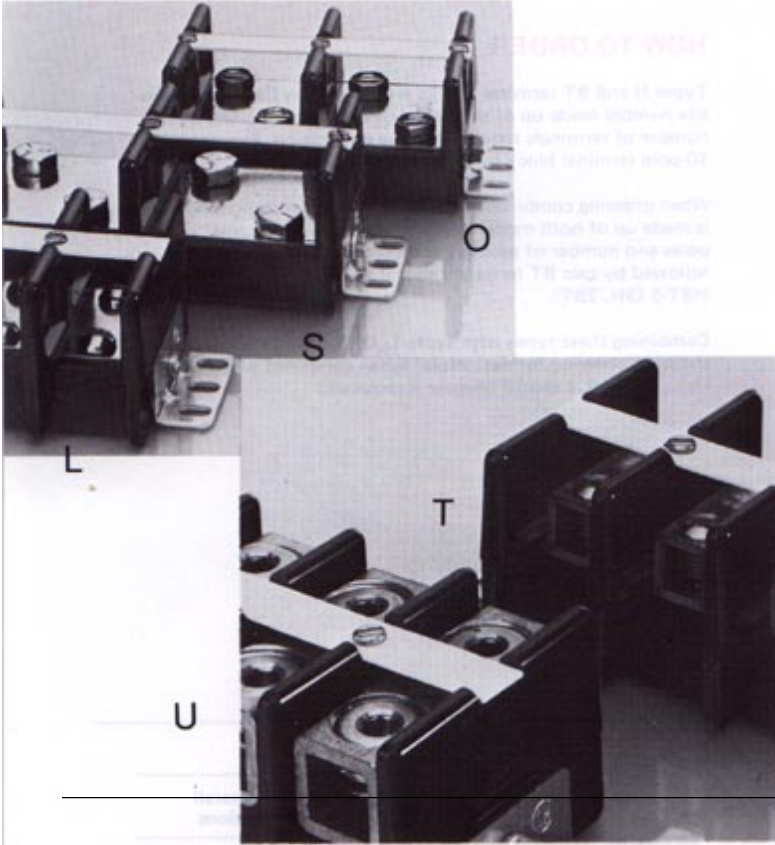

FEATURES

- **HEAVY LOAD TERMINATION FLEXIBILITY** – Designed for machine, switchboard and other heavy load terminations.
- **TUBULAR, HIGH PRESSURE SOLDERLESS CONNECTIONS** – Accommodates wire without lugging – tapped sidewalls for greater mechanical strength – electrolytically pure copper solderless connections provide 100% conductivity.
- **READILY ADAPTABLE TO SPECIAL APPLICATIONS** – Can be used for branch circuit termination with simple modification of standard terminal plate.
- **COMBINED STYLE DESIGN CAPABILITY** – all types can be combined with each other as well as with Types H and BT.
- **RATINGS AND WIRE SIZES TO MATCH HIGH CURRENT NEEDS** – Type L is rated at 100 amps/600 volts UL recognized for wire up to No. 1AWG. Type O: 125 amps/600 volts UL recognized for wire up to No1/0AWG. Type S: 225 amps/600 volts UL recognized for wire up to No. 4/0AWG. (Note UL requires the use of UL recognized lugs.)
- **HEAVY LOAD RATINGS AND WIRE SIZES** – Type T – rated 125 amps/600 volts – has headless slotted screw _ UL recognized for No. 6AWG to No. 1/0AWG wire. Type U is rated 250 amps/600 volts and features headless socket screw. UL recognized for No. 6AWG to 250MCM wire.
- **RECOGNITION AND LISTING** – UL recognized and CSA certified.



Recognized under the Components Program of Underwriters Laboratories, Inc. Standard 1059, Guide No. XCFR2, File No. E62557.

Guide No. 184-N-90, Report No. LR39186-1.

TERMINAL DESIGNATIONS

- | | |
|---|---|
| T | Tubular copper with tapped sidewalls and headless slotted screw. Accepts wire from No. 6AWG to no. 1/0AWG. |
| U | Tubular copper with tapped sidewalls and headless socket screw. Accepts wire from No. 6AWG to 250MCM. |
| L | Nickel-plated brass terminal bar with 1/4" – 20 plated round-head steel screws. Accepts wire up to No. 1AWG. |
| O | Nickel-plated brass terminal bar with 5/16" – 18 plated slotted hex-head steel screws. Accepts wire up to No. 1/0AWG. |
| S | Nickel-plated brass terminal bar with 3/8" plated hex-head steel screws. Accepts wire up to No. 4/0AWG. |

VARIATIONS

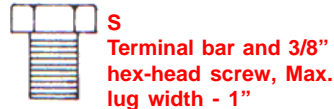
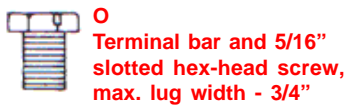
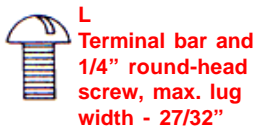
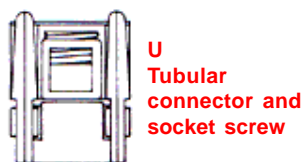
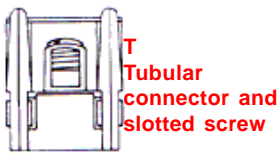
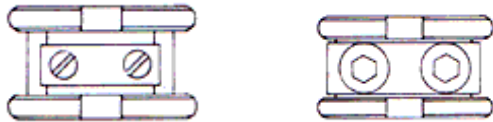

ACCESSORIES

Plain cover of 1/16" thick black bakelite is permanently positioned to block with two screws. Factory-assembled or customer-installed. To order, specify:

- T – Part No. 268A157-1 thru 6 terminals
- U – Part No. 268A157-1 thru 4 terminals
- L – Part No. 268A158-1 thru 12 terminals
- O – Part No. 268A159-1 thru 4 terminals
- S – Part No. 268A160-1 thru 4 terminals



ENGINEERING SPECIFICATIONS

Wire Range: UL Recognized –

- Type L – to No. 1AWG.
- Type O – to No. 1/0 AWG.
- Type S – to No. 4/0AWG.
- Type T – for No. 6AWG to no. 1/0AWG.
- Type U – for No. 6AWG to 250MCM.

Number of Terminals: Type L: 1 thru 12 Type T: 1 thru 6
 Type O: 1 thru 4 Type U: 1 thru 4
 Type S: 1 thru 4

Voltage Rating: CSA and UL – 600 volts.

Tightening Torque:

- L – 50 in.-lb. T – 50 in.-lb.
- O – 40 in.-lb. U – 275 in.-lb.
- S – 200 in.-lb.

Current Rating: 100 amps (Type L); 125 amps (Type O); 225 amps (Type S); 125 amps (Type T); and 250 amps (Type U).

Housing:

- Material: Phenolic
- Continuous Use Temp.: 150° C (302° F) (UL Index)
- Flammability Rating: 94V-1
- Water Absorption: (24 hrs. % wt. gain) 0.5%
- Chemical Resistance: Resistant to most organic solvents.

Breakdown Voltage:

- | | | |
|----------------------|--------------|--------------|
| | L | O |
| Terminal - Terminal: | 11,000V Typ. | 10,900V Typ. |
| Terminal - Ground: | 9,700V Typ. | 10,300V Typ. |
| | S | T |
| Terminal - Terminal: | 10,400V Typ. | 11,000V Typ. |
| Terminal - Ground: | 10,500V Typ. | 9,700V Typ. |
| | U | |
| Terminal - Terminal: | 9,000V Typ. | |
| Terminal - Ground: | 9,000V Typ. | |

NOTE: Specifications contained herein are subject to change without notice.

DIMENSIONS

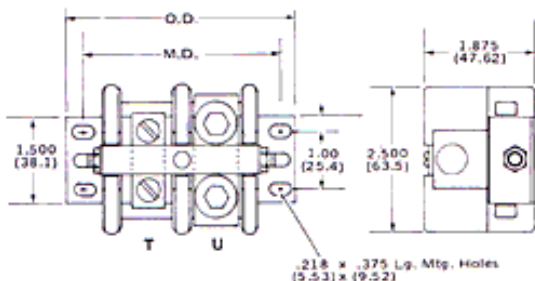
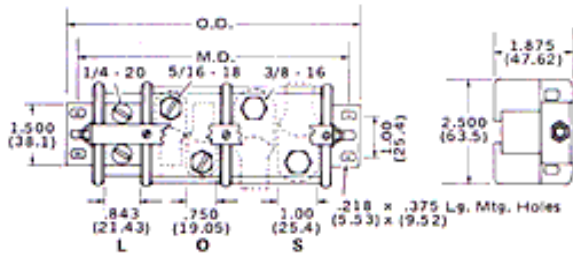

HOW TO ORDER

Types L, O, S, T and U terminal blocks are ordered by listing a composite number made up of the model designation followed by the number of terminals required for the application. Example: four-pole terminal block becomes stock number L-4, O-4, S-4, T-4 or U-4.

When ordering combinations of both types, the composite number is made up of both model designations followed by total number of poles and number of each type. A composite of two T terminals followed by two U terminals thus is converted to stock number TU-4 (2T, 2U). Combining these types with Types L, O, S, H and BT would follow the same ordering format. (Note – when combined with types H or BT a special adapter is required.)

No. of Terminals	Mounting Dimensions		Overall Dimensions	
	Inches	Metric (mm)	Inches	Metric (mm)
SERIES "L"				
1	2.183	55.46	2.683	68.16
2	3.342	84.88	3.842	97.58
3	4.500	114.31	5.000	127.01
4	5.659	143.73	6.159	156.43
5	6.817	173.16	7.317	185.86
6	7.976	202.59	8.476	215.29
7	9.134	232.01	9.634	244.71
8	10.293	261.44	10.793	274.14
9	11.451	290.86	11.951	303.56
10	12.610	320.29	13.110	332.99
11	13.768	349.71	14.268	362.41
12	14.927	379.14	15.427	391.84
SERIES "O"				
1	2.880	73.16	3.380	85.86
2	4.736	120.29	5.236	132.99
3	6.591	167.42	7.091	180.12
4	8.447	214.55	8.947	227.25
SERIES "S"				
1	3.440	87.38	3.9440	100.08
2	5.856	148.74	6.356	161.44
3	8.271	210.09	8.771	222.79
4	10.687	271.44	11.187	284.14
SERIES "T" and "U"				
1	2.183	55.46	2.683	68.16
2	3.342	84.88	3.842	97.58
3	4.500	114.31	5.000	127.01
4	5.659	143.73	6.159	156.43
5	6.817	173.16	7.317	185.86
6	7.976	202.59	8.476	215.29

Dimensions shown are ±0.030".

NOTE: Thru-bolt construction is amply strong for normal applications, but if excessive mechanical loads are expected, strain relief should be provided. Chart lists dimensions for up to six terminals per block, but longer lengths are available. Tie-down points are recommended for blocks exceeding four terminals for Type U and six terminals for Type T.

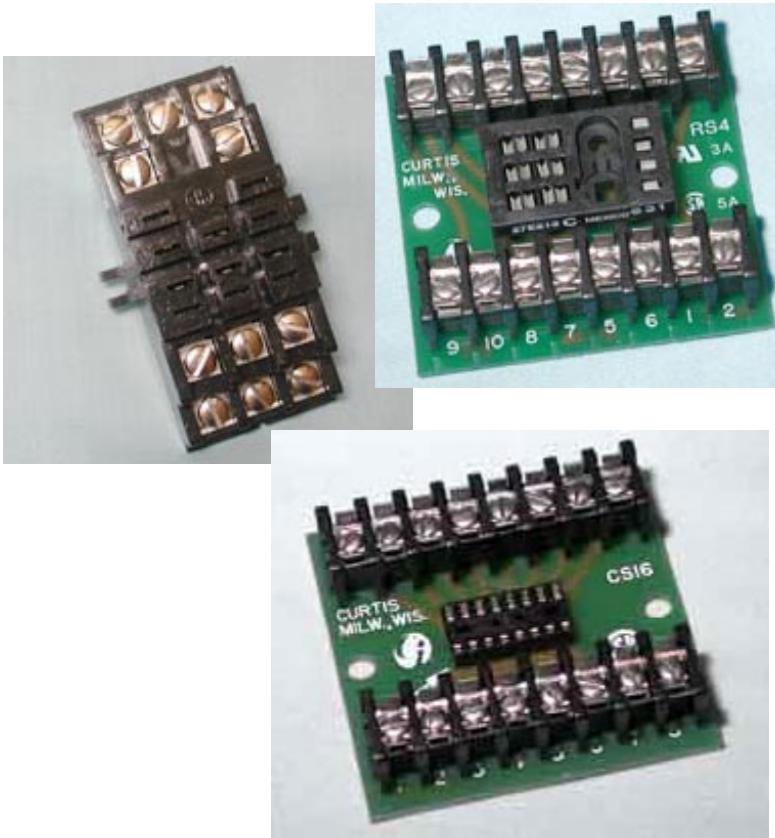

	Page
SNAP-IN SOCKET ASSEMBLIES.....	37
Track	
Ordering Information	
CUS SERIES.....	38
CUS8 and CUS11	
CUS5, CUS12 and CUS16	
CUS14 and CUS15	
RS SERIES.....	39
RS8, RS8SC, RS16	
RS11 and RS11SC	
RS2, RS4 and RS6	
RS SERIES.....	40
RS12, RS12SC, RS16 and RS16SC	
RS14	
RS15	
RS and CS SERIES.....	41
RS18 and RS19	
CS14 and CS16	
Accessories	
PS and RIS SERIES.....	42
PS Series	
RIS Series	

* SNAP-IN SOCKET ASSEMBLIES



CUS8

CUS12



RS11

- Permanent-numbered terminals for easy identification.
- New unitized, thermoplastic sockets with closed-back design which eliminates panel insulation, and resists breakage.
- Nickel-plated screw-type terminals on break-resistant barrier-type terminal block for fast, easy connection. Screw-type terminals on other models with captivated wire clamps to eliminate lugging.
- Compact, printed circuit design.
- Glass epoxy G-10 printed circuit boards.
- Relay sockets can be spaced out in track for convenient insertion of marking strips, for relay identification.
- High-quality sockets for maximum relay retention and electrical conductivity.

TRACK

- Assemblies snap in and out without disturbing adjacent units (except for dovetail design on CUS5, 12, 14, 15, and 16).
- Lengths up to 48" – holds up to 30 socket assemblies.
- Pre-punched track minimizes mounting time. (On lengths of 48", drilling and tapping is only required for two or three mounting screws instead of two holes per socket.)
- Wide center channel provides space for under-board components. Allows greater surface area for easy mounting with adhesive tape.
- Grey PVC thermoplastic, UL flame class 94V-0, suitable for ambient temperatures up to 50° C.
- Vertical rib track provides support to prevent PC board breakage – supplies spring retention and electrical base insulation.
- Optional snap-on end retaining clips available for long vertical mounts or extreme vibration if end socket assembly is not mounted with screws.
- Available in three popular widths for maximum circuit design flexibility.
TR1 for 2-3/16" PC board or socket.
TR2 for 2-3/4" PC board or socket.
TR3 for 3-1/4" PC board or socket.

ORDERING INFORMATION

Relay socket assemblies can be ordered in parts from (assemblies and track separate) or factory assembled in specific length units. When ordering factory assembled units, specify type – number of sockets in continuous one-piece precut track; e.g. – order RS8-17 for a track containing 17 RS8 relay socket assemblies.

* Many Curtis Socket Assemblies are recognized under the components program of Underwriters Laboratories, Inc., under File No. E59934. These units are marked with a on  the following pages.

Socket Assemblies listed by Canadian Standards Association are marked with a  and are covered by Report No. LR19623.

RS SERIES

RS8 and RS8SC 8-PIN OCTAL-TYPE SOCKET ASSEMBLIES

SPECIFICATIONS

- Rating: 10 amps, 250 volts.
 Track: TR2
 48" length holds up to 24 sockets.
 Terminals: RS8 – No. 6-32 screws, 7/16" C. to C. spacing.
 RS8SC – No. 6-32 screws with captivated wire clamp, 7/16" C. to C. spacing (no lugs required).
 Wire: RS8 – up to No. 12AWG (lugs are recommended on wire larger than No. 16AWG).
 RS8SC – up to No. 12AWG.
 Sockets: 8-pin octal receptacle to accept standard 2PDT relays and timers. Recessed slotted center post chamber allows relays to be rocked out without danger of damaging relay center posts. PC board has center post clearance hole to allow relays with screws in center post. Phosphor bronze contacts for better pin contact and retention.

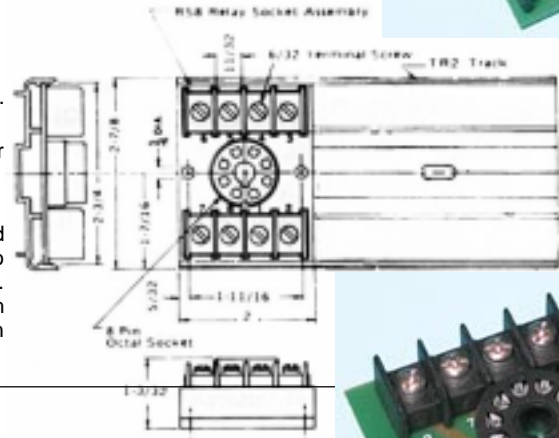

RS11 and RS11SC 11-PIN OCTAL-TYPE SOCKET ASSEMBLIES

SPECIFICATIONS

- Rating: 10 amps, 250 volts.
 Track: TR2
 48" length holds up to 16 sockets.
 Terminals: RS11 – No. 6-32 screws, 7/16" C. to C. spacing.
 RS11SC – captivated wire clamp, 7/16" C. to C.
 Wire: RS11 – up to No. 12AWG. (lugs are recommended on wire larger than 16AWG).
 RS11SC – up to two No. 12AWG.
 Sockets: 11-pin octal receptacle to accept 3PDT relays. Refer to RS8 socket for features.

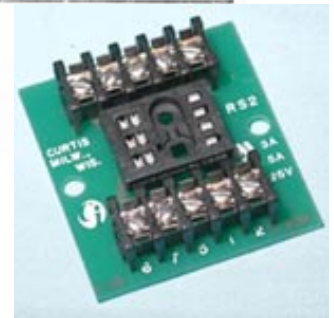
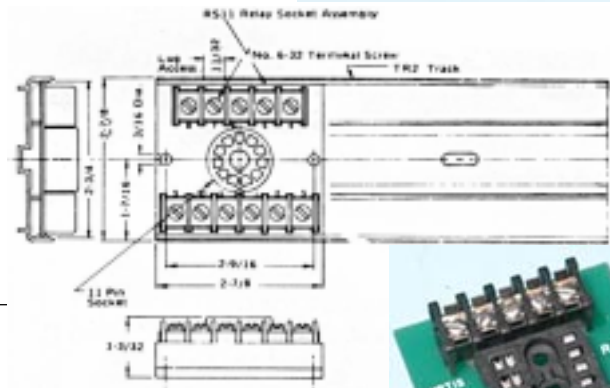

RS2, RS4 and RS6 10, 16, and 22-PIN SQUARE-BASE MINIATURE RELAY-TYPE SOCKET ASSEMBLIES

SPECIFICATIONS

- Rating: 5 amps, 125 volts, (UL rated 3 amps, 125 volts)
 Track: TR1
 48" length holds up to 24 RS2 sockets, 21 RS4 sockets and 16 RS6 sockets.
 Terminals: No. 2-56 screw with clamp – 1/4" C. to C. spacing.
 Wire: Up to No. 16AWG.
 Sockets: RS2 – 10-pin receptacle to accept miniature 2PDT relays with latching coils.
 RS4 – 16-pin receptacle to accept miniature 4PDT relays with latching coils.
 RS6 – 22-pin receptacle to accept miniature 6PDT relays with latching coils.

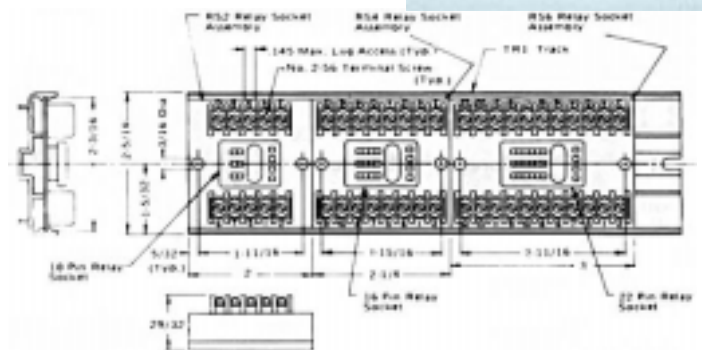

CURTIS RS SERIES

RS12, RS12SC, RS16 and RS16SC

8 and 11-PIN UNITIZED OCTAL-TYPE SOCKET ASSEMBLIES

SPECIFICATIONS

- Rating: 10 amps, 250 volts.
 Track: TR3
 48" length holds up to 16 RS12 or RS12SC sockets.
 48" length holds up to 22 RS16 or RS16SC sockets.
 Terminals: RS12 and RS16 – No. 6-32 screws, 7/16" C. to C. spacing.
 RS12SC and RS16SC – captivated wire clamp 7/16" C. to C. spacing.
 Wire: RS12 and RS16 – up to No. 12AWG (lugs are recommended on wire larger than No. 16AWG).
 RS12SC and RS16SC – up to two No. 12AWG.
 Sockets: RS12 and RS12SC – 11-pin receptacle to accept 3PDT relays.
 RS16 and RS16SC – 8-pin receptacle to accept 2PDT relays.
 Note: RS12 and RS12SC – CSA rating is 10 amps, 125 volts.

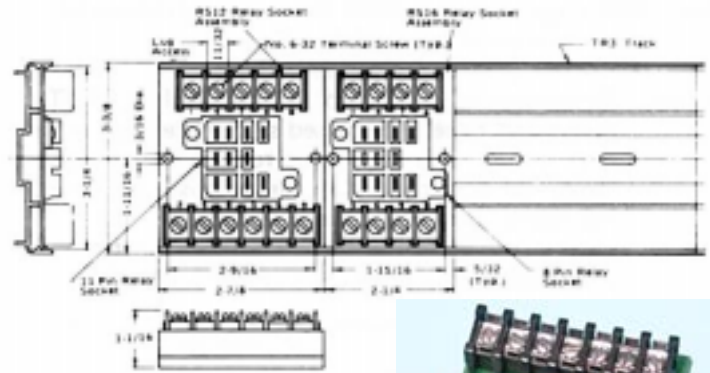
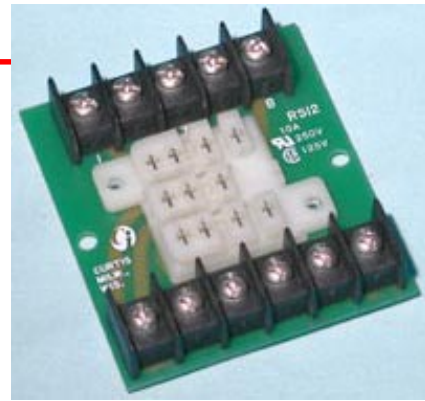

RS14

5, 8 and 11-PIN UNITIZED SQUARE-BASE RELAY-TYPE SOCKET ASSEMBLIES

SPECIFICATIONS

- Rating: 5 amps, 125 volts.
 Track: TR2
 48" length holds up to 24 sockets.
 Terminals: No. 2-56 screws with clamps. (1/4" C. to C. spacing.)
 Wire: Up to No. 16AWG wire.
 Sockets: 14-pin receptacle to accept miniature 4PDT relays.

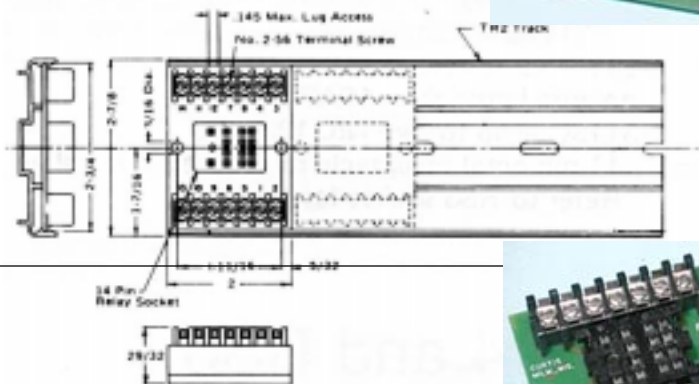
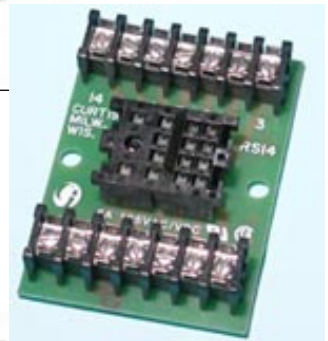

RS15

14 and 15-PIN UNITIZED SQUARE-BASE RELAY-TYPE SOCKET ASSEMBLIES

SPECIFICATIONS

- Rating 5 amps, 125 volts.
 Track: TR1
 48" length holds up to 21 sockets.
 Terminals: No. 2-56 screws with clamps. (1/4" C. to C. spacing.)
 Wire: Up to No. 16AWG wire.
 Sockets: 15-pin receptacle to accept grounded miniature 4PDT relays.

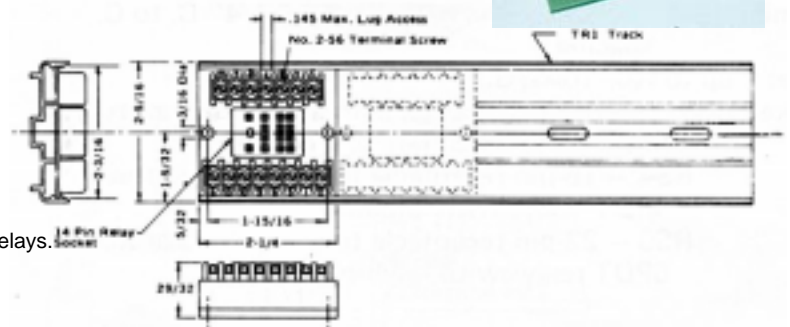

RS and CS SERIES

RS18, RS18SC, 19 and 19SC 8 and 14-PIN SQUARE-BASE SOCKET ASSEMBLIES FOR MINIATURE SPDT and DPDT RELAYS

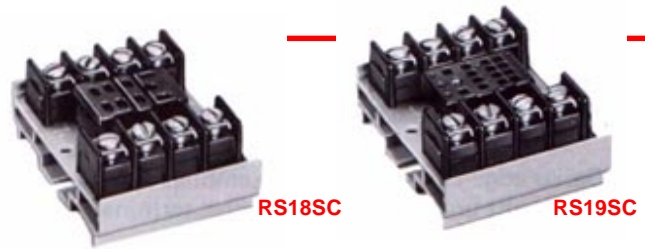

SPECIFICATIONS

- Rating: 10 amps, 250 volts.
Track: TR 2
48" length holds up to 24 sockets.
Terminals: RS18/RS19 – No. 6-32 screws on 7/16" centers.
RS18SC/RS19SC – No. 6-32 screws with captivated wire clamp.
Wire: Up to No. 12AWG wire.
Sockets: RS18 – 8-pin receptacle to accept SPDT or DPDT relays.
RS19 – 14-pin receptacle to accept SPDT or DPDT relays.
Will also accept 4PDT relays with contacts paralleled.

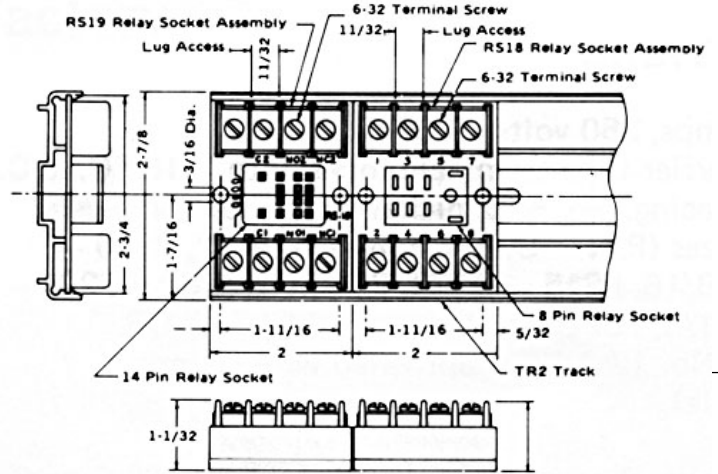

CS14 and CS16 14 and 16-PIN DUAL IN-LINE SOCKET ASSEMBLIES

SPECIFICATIONS

- Track: TR3
48" length holds up to 24 CS14 sockets.
48" length holds up to 21 CS16 sockets.
Terminals: No. 2-56 screws with clamps. (1/4" C. to C. spacing)
Wire: Up to No. 16AWG wire.
Sockets: CS14 – 14-pin dual in-line socket.
CS16 – 16-pin dual in-line socket.

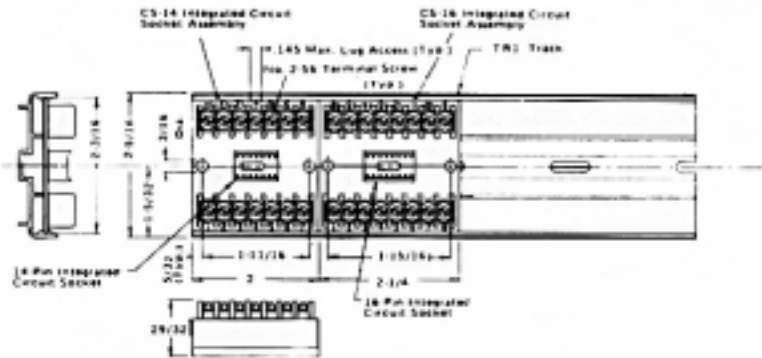

ACCESSORIES

- 18836 – (RS2 socket only)
- 18837 – (RS4 socket only)
- 18838 – (RS6 socket only)
- 18830 – (RS14 & 15 socket only)
- 18831 – (RS12 socket only)
- 18835 – (RS12 socket only)
- 18835 – Round 11-pin socket (RS11)
- 18821 – Round octal socket (RS8)
- 11832 – Square 8-pin socket (RS16)
- 44600 – Relay tie down spring
- 44613 - Tie down bail (CUS5, 12, 16)
- 44617 - Relay hold down clip (CUS5, 12, 16)
- 44610 – Tie down bail (CUS14 & 15)
- 62610 – TR track end clips

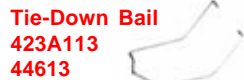

CURTIS PS and RIS SERIES

PS SERIES

PC BOARD EDGE-CONNECTOR ASSEMBLIES

Curtis PS Series edge-connector assemblies interface edge-type printed-circuit boards to electrical terminals. Eliminates hand soldering operations.

SPECIFICATIONS

- Rating:** 5 amps, 250 volts.
Track: TR 2
Terminals: Barrier type terminal blocks with 7/16" C. to C. spacing. No. 6-32 nickel-plated steel screws. Sizes (P/N – O.D.): PS6 – 1-29/32, PS10 – 2-9/16, PS15 – 3-7/8, PS18 – 4-9/32, PS22 – 5-1/8, PS22G (with card guide) – 5-1/8.
Wire: Up to No. 12AWG (Captivated wire clamps available.)
Edge Connectors: Single contact spacing on 0.156" C. to C.
Terminal Designations: PS – No. 6-32 screws, PSW – Wire clamp captivated to no. 6-32 screw.

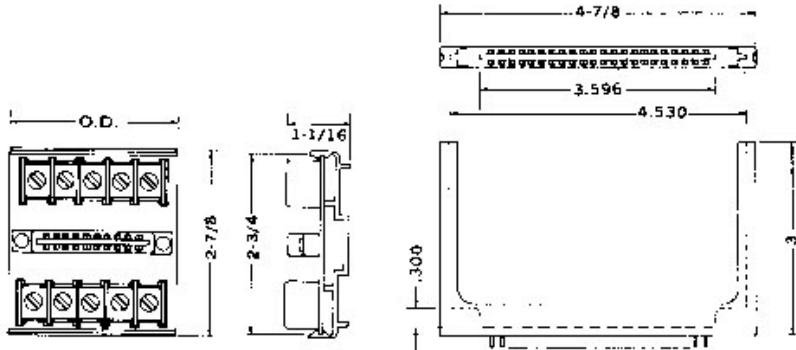

RIS SERIES

RIBBON CABLE INTERFACE SOCKETS

SPECIFICATIONS

- Rating:** 1 amp, 125 volts.
Track: TR 1
 48" length holds up to:
 16 RIS20 Assemblies
 12 RIS26 Assemblies
 10 RIS34 Assemblies
 8 RIS40 Assemblies
 7 RIS50 Assemblies
Terminals: No. 2-56 screws with clamp, 1/4" C. to C. spacing.
Wire: Up to No. 16AWG.
Headers: Contain two rows of .025" square gold-plated pins on .100" centers with hood retainers. Designed to mate with all standard connectors. (Other types of headers are available on special order. Contact factory for additional information.)

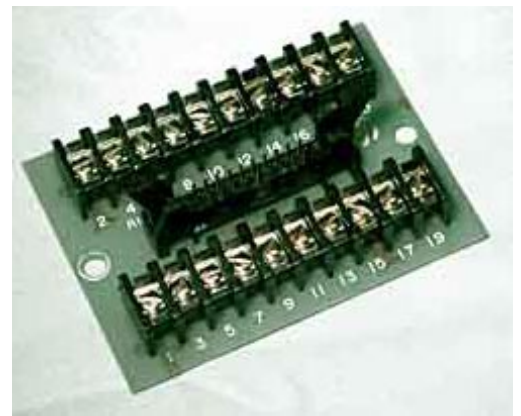

FEATURES

- **MATING CONVENIENCE** – Solves the problem of mating ribbon or flat cable with discrete wiring.
- **VERSATILITY** – Track mounting provides assembly ease for single or multiple units.
- **WIRE CLAMP ON TERMINAL BLOCKS** – Eliminates need for lugs or wrapping wires.
- **SPECIALS** – Other lengths and connector types available on special order.

RIS Socket	No. of Pins	M.D. Dimension		O.D. Dimension	
		Inches	Metric	Inches	Metric
RIS20	20	2.688	(68.275)	3.000	(76.200)
RIS26	26	3.438	(87.325)	3.750	(95.250)
RIS34	34	4.438	(112.725)	4.750	(120.650)
RIS40	40	5.188	(131.775)	5.500	(139.700)
RIS50	50	6.438	(163.525)	6.750	(171.450)

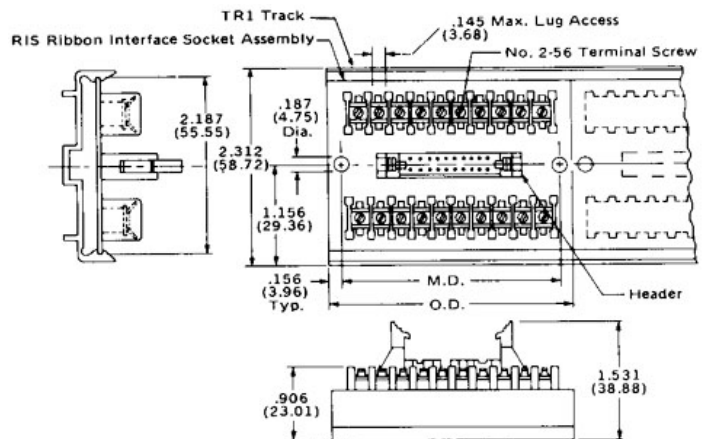

SERIES 32500 .325" Center-to-Center Spacing

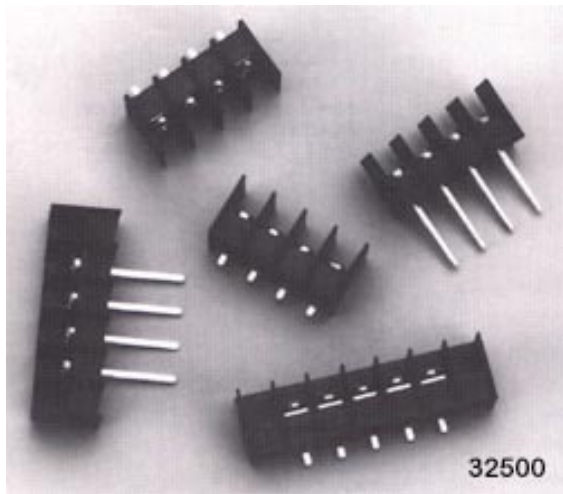

FEATURES

- **COMPLETE LINE OF .325" OFFSET BLOCKS** – including base mount, P.C. Pin, wire wrap, turret, and right angle terminals.
- **OPEN OR TRI BARRIER DESIGNS** – to meet your wiring requirements.
- **DURABLE BASE MATERIAL** – with a 94V-0 flammability rating.
- **MOLDED IN STANDOFFS** – to aid in the board cleaning.
- **A MULTITUDE OF SCREW AND WIRE TERMINATIONS AVAILABLE** – including wire clamps, wire ready screws, and combo head screws.

VARIATIONS

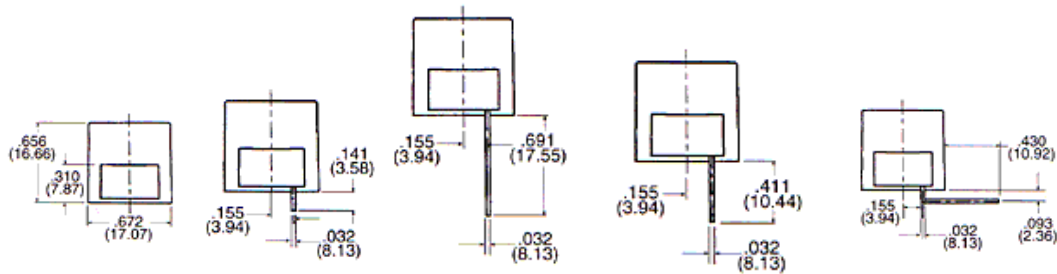

VARIATIONS

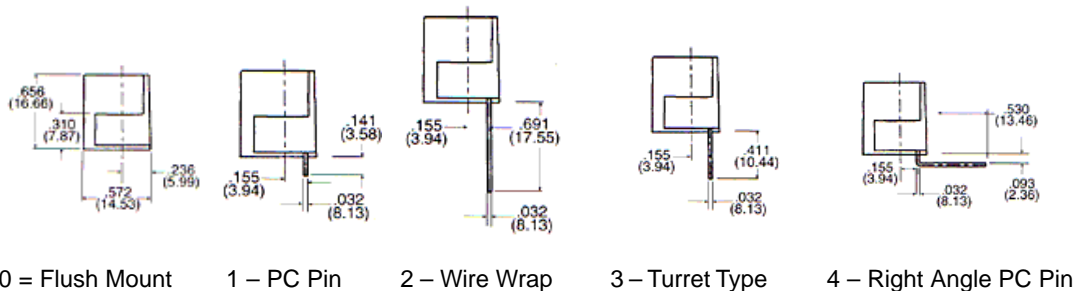

INSERT DIMENSIONS
STYLES 1, 2 & 4
.062" X 0.32"

STYLE 3
.100" X .032"



HOW TO ORDER SERIES 325

Series Design	Molding Style	Insert or Bottom Termination	Screw, Hardware or Top Termination	Number of Positions	Special or Optional Designs
3 2 5					
<ul style="list-style-type: none"> 0 = Open Style with Mounting Ears 1 = Open Style w/o Mounting Ears 2 = Tri Barrier with Mounting Ears 3 = Tri Barrier w/o Mounting Ears 	<ul style="list-style-type: none"> 0 = Base Mount Insert 1 = P.C. Pin 2 = Wire Wrap Pin 3 = Turret Type Pin 4 = Right Angle P.C. Pin 	<ul style="list-style-type: none"> 0 = Steel Combo Head Screw 1 = Wire Clamp Head Screw 2 = Brass Combo 3 = Stainless Steel Screw 5 = Supplied w/o Screws 6 = Quick Connects 8 = Captivated Steel Combo Head 9 = Captivated Wire Clamp 	<ul style="list-style-type: none"> 0 = No additional options A-Z = To be assigned by factory 		

P.C. BOARD DRILLING DIMENSIONS

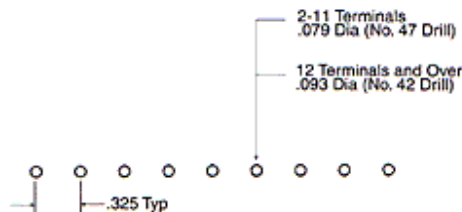

WIRE CLAMPS

32500 Series, Wire Clamp captivated to No. 6-32 screw eliminates the need for lugs. May be ordered factory assembled or bulk. Part Number for bulk part is #05824700.

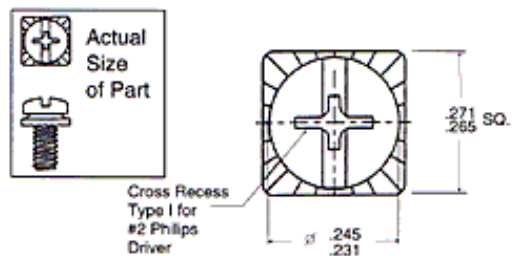

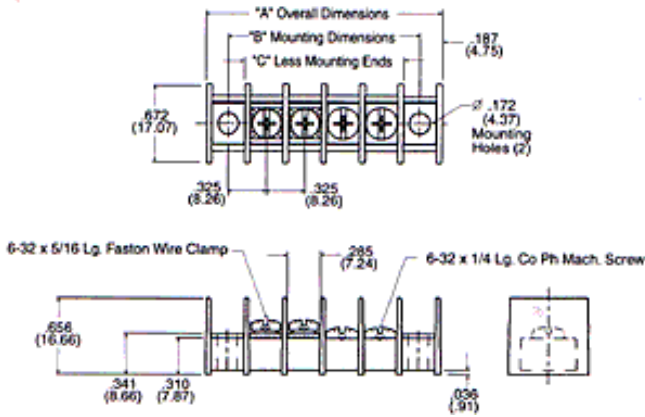

Series 32500 Surface Mount With or Without Mounting Ends

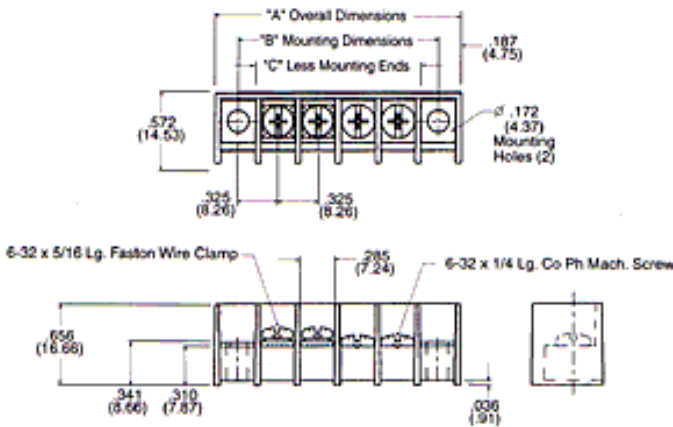

Series 32500 Tri-Barrier Surface Mount With or Without Mounting Ends

ENGINEERING SPECIFICATIONS

Center-to-Center Spacing: .325"

Wire Range: No. 22AWG to 14AWG.

Number of Terminals: 1 thru 26 (28 positions without mounting holes)

Voltage Rating: 300V

Tightening Torque: 9 in.-lb.

Current Rating: 15 amps (20 amps with 12AWG & Lugs)

Housing:

- Material: Polypropylene
- Continuous Use Temp.: 105° C (UL index)
(UL Index)
- Flammability Rating: 94V-0
- Water Absorption: .03%
- Breakdown Voltage

Terminals: Brass - Tin Plated

Series 32500 with Mounting Ends

No. of Terminals	DIMENSIONS	
	B ± .031 Mounting Dim.	A .031 Overall Dim.
1	.650	1.023
2	.975	1.348
3	1.300	1.673
4	1.625	1.998
5	1.950	2.323
6	2.275	2.648
7	2.600	2.973
8	2.925	3.298
9	3.250	3.623
10	3.575	3.948
11	3.900	4.273
12	4.225	4.598
13	4.550	4.923
14	4.875	5.248
15	5.200	5.573
16	5.525	5.898
17	5.850	6.223
18	6.175	6.548
19	6.500	6.873
20	6.825	7.198
21	7.150	7.523
22	7.475	7.848
23	7.800	8.173
24	8.125	8.498
25	8.450	8.823

Series 32500 without Mounting Ends

No. of Terminals	DIMENSIONS
	C ± .031 Less Mtg. Ends
1	.373
2	.698
3	1.023
4	1.348
5	1.673
6	1.998
7	2.323
8	2.648
9	2.973
10	3.298
11	3.623
12	3.948
13	4.273
14	4.598
15	4.923
16	5.248
17	5.573
18	5.898
19	6.223
20	6.548
21	6.873
22	7.198
23	7.523
24	7.848
25	8.173
26	8.498
27	8.823
28	9.148

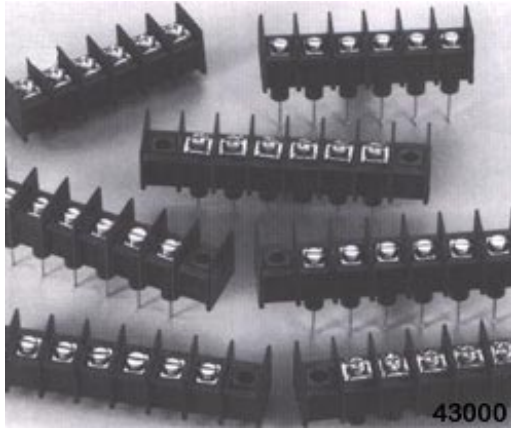

FEATURES

- Cost-competitive line of 7/16 (11.11mm) centerline terminal blocks provides design engineers with multitude of selection choices: base mount and feed thru styles with P.C. pin, turret, quick connect, wire wrap and right angle. Available in up to 28 positions.
- Rated up to 30 AMPS, 600 volts. Note: 30 AMP rating requires 10AWG wire and lugs.
- Accepts very broad wire range from 22AWG to 12AWG. Variety of top terminations including 6-32 and 8-32 screws, quick connects, wire clamps, jumpers and covers.
- Unique Curtis contact design helps eliminate fracturing of solder join due to pin twist.
- Plated brass inserts are standard on all Series 43000 terminal blocks. Standoffs molded into the blocks inhibit the trapping of solder flux - makes it easier to clean boards.
- All terminal blocks for electronic use are made from highly durable, self-extinguishing polypropylene material rated 94 V-0 by Underwriters Laboratories, Inc.
- Custom built terminal blocks for special applications are available. Contact any authorized Curtis distributor or representative, or call the factory direct.



Recognized under the Components Program of Underwriters Laboratories, Inc. Standard 1059, Guide No. XCFR2, File No. E62557.

Guide No. 184-N-90, Report No. LR39186-1.

VARIATIONS SERIES 43000

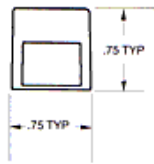

0 - Flush Mount

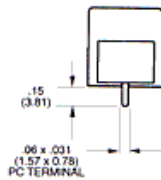

1 - Printed Circuit Pin

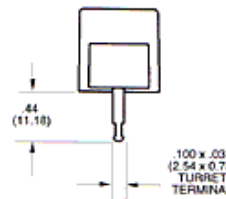

2 - Turret type Solder Terminal

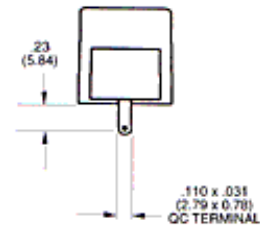

3 - Quick Connect .110"

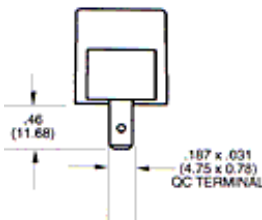

4 - Quick Connect .187"

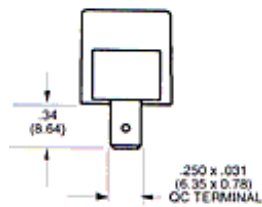

5 - Quick Connect .250"

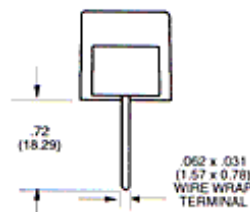

6 - Wire Wrap Pin

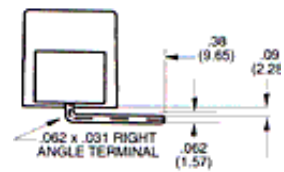

7 - Right Angle Printed Circuit Pin

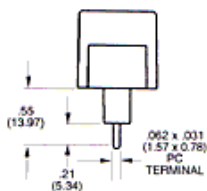

1 - Printed Circuit Pin

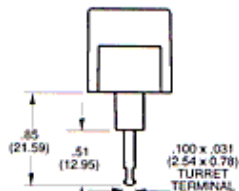

2 - Turret Type Solder Terminal

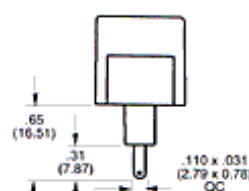

3 - Quick Connect .110

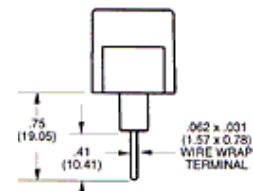

6 - Wire Wrap Pin (extended pc pin)

SERIES 43000 SURFACE MOUNT WITH MOUNTING ENDS

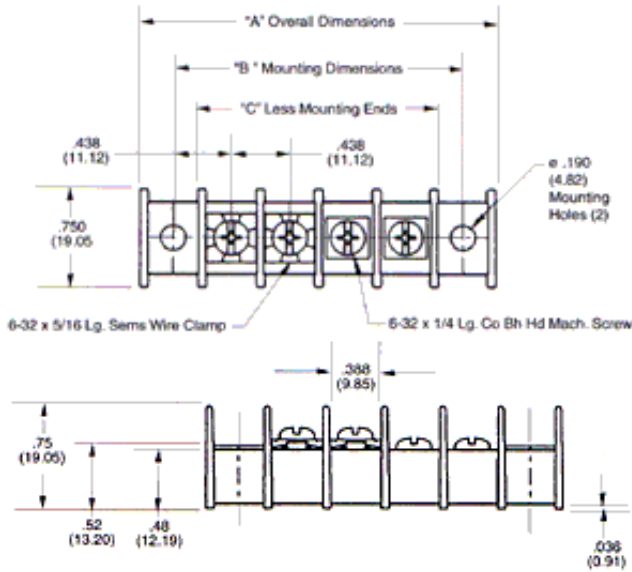

SERIES 43000 FEED-THRU

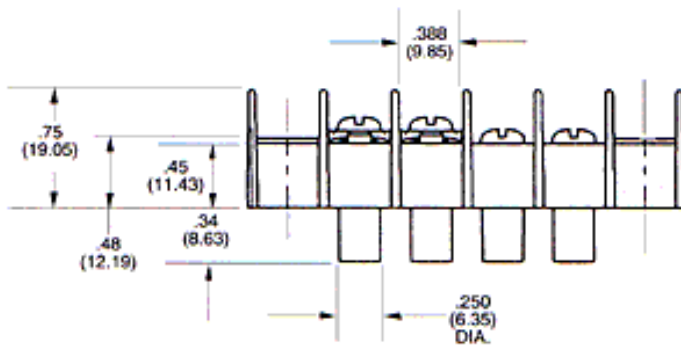

ENGINEERING SPECIFICATIONS

- Center-to-Center Spacing:** 7/16" (11.11 mm)
- Number of Terminals:** 1 thru 26 (28 positions available only without mounting ends.)
- Voltage Rating:** 600 volts
- Tightening Torque:** Wire Binding Screw 9 in.-lbs.
Wire Clamp 9 in.-lbs.
- Current Rating:** 30 amps
- Housing:**
 - Material: Polypropylene
 - Continuous Use Temp.: 105° C (UL Index)
 - Flammability Rating: 94V-0
 - Water Absorption: .03%
 - Chemical Resistance: Excellent
 - Breakdown Voltage: 3,000V Typ.
- Metal Parts:** Brass – Tin Plated

SERIES 43000 WITHOUT MOUNTING ENDS

NO. OF TERMINALS	C ± .031 LESS MT. ENDS	NO. OF TERMINALS	C ± .031 LESS MT. ENDS
1	.500	1	.500
2	.938	2	.938
3	1.375	3	1.375
4	1.813	4	1.813
5	2.250	5	2.250
6	2.688	6	2.688
7	3.125	7	3.125
8	3.563	8	3.563
9	4.000	9	4.000
10	4.438	10	4.438
11	4.875	11	4.875
12	5.313	12	5.313
13	5.750	13	5.750
14	6.188	14	6.188

SERIES 43000 WITH MOUNTING ENDS

NO. OF TERMINALS	A ± .031 OVERALL DIM.	B ± .031 MOUNTING DIM.	NO. OF TERMINALS	A ± .031 OVERALL DIM.	B ± .031 MOUNTING DIM.
1	1.375	.875	14	7.063	6.563
2	1.813	1.313	15	7.500	7.000
3	2.250	1.750	16	7.938	7.438
4	2.688	2.188	17	8.375	7.875
5	3.125	2.625	18	8.813	8.313
6	3.563	3.063	19	9.250	8.750
7	4.000	3.500	20	9.688	9.188
8	4.438	3.938	21	10.125	9.625
9	4.875	4.375	22	10.563	10.063
10	5.313	4.813	23	11.000	10.500
11	5.750	5.25	24	11.438	10.938
12	6.188	5.688	25	11.875	11.375
13	6.625	6.125	26	12.313	11.813

HOW TO ORDER SERIES 43000

Molding	Insert or Bottom Termination	Insert/Screw Dimension	Hardware or Top Termination Design	Number of Positions	Special or Optional Designs
0 = Surface Mount w/ Mounting Ears 1 = Surface Mount w/o Mounting Ears 2 = Insulated Feed Thru w/ Mounting Ears 3 = Insulated Feed Thru w/o Mounting Ears	0 = Surface Mount, no Bottom Termination 1 = Printed Circuit Pin 2 = Turret Type Solder Terminal 3 = Quick Connect - 110" 4 = Quick Connect - 187" 5 = Quick Connect - 250" 6 = Extended P.C. Pin or Wire Wrap 7 = Right Angle Printed Circuit Pin Note: Option 4 & 5 only available on surface mount style molding		0 = Standard Zinc Plated Steel Screw, Combo Head 1 = Wire Clamp Screw 2 = Nickel Plated Brass Screw 3 = Stainless Steel Screw 5 = Supplied w/o Screws 6 = Quick Connects. See Accessories for Variations 8 = Captivated Screw Option 0 = 6-32 Insert and Screw 1 = 8-32 Insert and Screw	0 = No additional options A thru Z to be assigned by factory. Please call for proper designation Available 01 thru 26 w/ Mounting End 01 thru 28 w/o mounting ends	

P.C. BOARD DRILLING DIMENSIONS

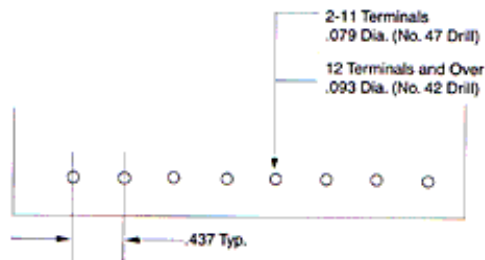

RECOMMENDED PANEL CUTOUT DIMENSIONS

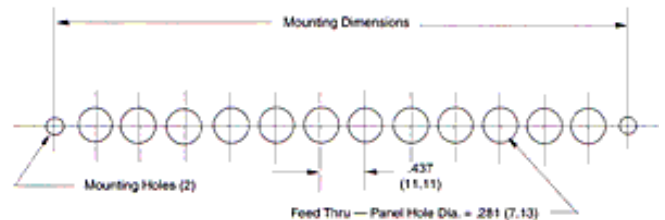

SERIES 43000 ACCESSORIES

ACCESSORIES

QUICK-CONNECT TERMINALS

43000 – Available with .250" x .032" quick-connect tabs of tin-plated brass, held in place by terminal screws. Nine styles ... one to six terminations per pole. Factory-assembled or supplied bulk.

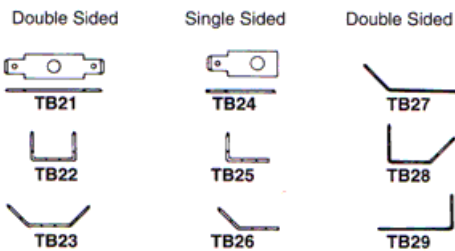

WIRE CLAMPS

43000 – Wire clamp captivated to No. 6-32 screw eliminates need for lugs. Accepts up to No. 12AWG wire. May be ordered factory installed or loose.

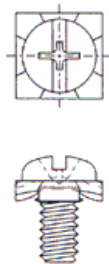

MARKING STRIPS

43000 – Pre-punched black fiber ... mounts under block. May be imprinted to customer specifications. To order, specify: part No. 267A19-1 thru 26 (with mounting hole); Part No. 267A218-1 thru 26 (less mounting hole).



COVERS

43000 – Rigid .030" thick self-extinguishing vinyl. Black matte-finished on both sides. May double as marking strip when imprinted with white ink. Complete with spring clips for attaching to mounting positions. Part No. 0196 __ _000, 1 thru 26 poles. Example 019605000 would be a 5 pole cover.



TERMINAL BLOCK JUMPERS

43000 – Plated brass "Rooster comb" design Type 267A42 permits connections of two to 18 poles. To order specify: Part No. 267A42-___. Example: 267A42-12 equals 12 pole jumper.



TINNERMAN NUT

43000 – for special mounting of terminal Part No. TN-375.

Part No. TN-375
for long feed thru

