

# 1 ROCKER SWITCHES

## New Generation Rocker (NGR)

### DESCRIPTION

Eaton presents its New Generation Rocker (NGR) Series. This field-proven line of full sized rocker switches, initially developed for the Heavy Truck Industry is now found in a variety of vehicle related applications. The NGR offers both European styling and ergonomic design while still providing the solid durability that you have come to expect from Eaton switches. Illuminated and non-illuminated versions with either incandescent bulbs or LED's are available in

either dependent or independent circuits and in a variety of popular switching circuits. The NGR also offers a variety of rocker buttons and indicators with laser-etched or pad printed icons, insertable lenses and adhesive-backed labels.

### SPECIFICATIONS

#### Ratings:

15A @ 125V ac, 10A@ 250V ac.  
15A @ 28V dc (14V dc rating).  
Approvable under stringent UL and CSA standards.

For information, contact your Eaton Sales Representative.

#### Circuits:

1PST, 1PDT, 2PST, and 2PDT.  
Maintained and momentary action.

#### Contact Mechanism:

Slow-make/Slow-break contact mechanism.

Butt action contact mechanism designed specifically for use on ac and low voltage dc applications.

## FLEXIBLE ORDERING SYSTEM

PAGE

You can order assembled switches or the switch base and actuator separately.

Use the final code in the switch base catalog number (page 1.40) to denote assembly instructions.



**Switch Base** ..... 1.40



**Rocker Button/Actuator** ..... 1.46-1.47



**Lens** ..... 1.48



**Indicator Base** ..... 1.40



**NGR Complete Indicator** ..... 1.48



**Indicator Cap** ..... 1.49

### REFERENCE

Circuit Diagrams for Switch Body Catalog Number ..... 1.41-1.45

Icons for Rockers, Indicators and Indicator Caps ..... 1.50-1.51

Dimensions ..... 1.52-1.55

Accessories ..... 4.26-4.27

**Contact Material:**

*Standard Construction:*

Movable — Copper alloy with silver alloy contact face button.

Stationary — Silver-plated copper alloy with silver alloy contact face button.

**Mechanical Life:**

250,000 operations, minimum.

**Terminal Type:**

Standard .250" spade, silver-plated copper alloy.

**Base Material:**

High grade thermoplastic molding material.

**Dielectric:**

1,000V RMS, minimum.

**Operating**

**Temperature Range:**

-40°C to +85°C (-40°F to 185°F).

**Mounting Means:**

Snap-in mounting with plastic bezel.

**Mounting Hole:**

Rectangular panel cutout 44 x 22mm (1.734 x .867").

**Panel Thickness:**

1.00 to 4.00mm (.040 to .156"). Best results obtained between 1.50 and 3.00mm (.060 and .118"). On sealed versions, recommended panel thickness between 2.00 and 3.00mm (.079 and .118").

**Sealing:**

Standard switch provides splash and dust resistance to IP42. The sealed version is sealed to IP67 when supplied with panel seal.

**Rocker:**

The standard actuator for the NGR is a clean, European-styled, two face rocker made of high quality thermoplastic material. The rocker is replaceable and snaps on and off the switch. Both the rocker and the bezel are supplied with an aesthetically pleasing

matte finish. Different colors are also available, but black is standard. Rockers can be ordered separately.

**Lighting:**

Each switch is capable of accommodating two incandescent light bulbs or LED's for lighting purposes. A lamp or LED can be located at either end of the switch and oriented to be circuit dependent or independent. The incandescent bulbs are front replaceable. Two lamp or LED voltages, 14V dc and 28V dc are standard. For additional voltages or colors, consult your Eaton Sales Representative.

**Legends:**

Two legend areas are provided on the ends of each rocker of sufficient size to accommodate two lines consisting of four Helvetica Narrow 12 point characters. Legends may be non-illuminated or illuminated. The NGR offers three styles of illuminated legends.

*Single Piece Back-Lit* — Back-lighting is a high quality automotive/truck industry technique. The legend can appear daylight white or dead-front when non-illuminated but, depending on the back-lit color chosen, will change color when illuminated. Examples of standard back-lit legends are found on [pages 1.50-1.51](#).

*Snap-In Lenses* — This rocker will have either one or two snap-in lenses in the legend areas. Legends are typically pad-printed on the lens in black or white. Snap-in lenses are available in six standard colors and can be ordered separately.

*Label Rocker* — This rocker has a one-piece adhesive backed label inserted into a recessed area on the face of the button. Legends can be done in several colors and be illuminated or non-illuminated. Contact your

Eaton Sales Representative for suggested sources.

**Options:**

- Common lamp ground jumper for dual lamp units.
  - Multiple LED's for daylight readability.
  - Additional colors of rockers, mounting bezels, and lenses are available.
  - Special circuits.
  - Special ratings.
  - Pad-printed legends on lens, rocker and bezel.
  - Special lamps and lamp voltages.
  - Dry circuit capabilities.
  - Custom back-lit legends available.
  - Reversing jumpers (internal).
  - Gang mounting system. [See page 4.27.](#)
  - Locking rocker with locking feature in "UP", and/or "DOWN" positions.
  - Indicators with laser etched, or insertable lenses or adhesive labels.
  - IP67 rated sealed switch.
  - Polarized lock-on connectors: [See page 4.26.](#)
    - 28-5637-2 for Packard terminals.
    - 28-5940 for AMP terminals.
  - Panel plug: 17-21543.
  - Replacement bulb Catalog Number:
    - 14V . . . 28-5901.
    - 28V . . . 28-5909.
- For more information on additional options, contact your Eaton Sales Representative.

**Approvals:**

Approvable under stringent UL and CSA standards. For information, contact your Eaton Sales Representative.



Sealed NGR Switch with Decorative Rocker



Palm Guard Top with Decorative Rocker



NGR Indicator



NGR Switch with Locking Rocker

# 1 ROCKER SWITCHES

## New Generation Rocker Switches (continued)

### HOW TO ORDER — SWITCH BASE/INDICATOR BASE

To determine your **Complete Catalog Number**, you must start with the appropriate **Base Prefix** and add the appropriate **Code Letters and/or Numbers** as in the example below:

Add each appropriate Number or Letter...								...to get to your Complete Catalog Number
Base Prefix	Circuit Number	Frame Style	Frame Color	Switch Contact Plating	"A" Lamp Type and Color	"B" Lamp Type and Color	Rocker Assembled	Complete Catalog Number
NGR	1501	1	B	N	A	0	Y	NGR15011BNA0Y
NGRIND	—	—	—	—	A	0	—	NGRINDA0

### SWITCH BASE/INDICATOR BASE SELECTION TABLE

Switch Series (Unsealed)	Circuit and Lamp Configuration	LETTERS AND NUMBERS — ADD TO BASE CIRCUIT NUMBER											
		Frame Style		Frame Color		Switch Contact Plating ❶		"A" Lamp: Type and Color		"B" Lamp: Type and Color		Rocker Assembled	
		Style	Code	Color	Code	Plating	Code	Type and Color	Code	Type and Color	Code	Assembled	Code
		SWITCH BASE						SWITCH BASE					
NGR	See pages 1.41-1.45. Circuits show lighting options available.	Rocker and Paddle Frame	1					No Lamp	0	No Lamp	0	Yes No (To Order Rocker Button, see pages 1.46-1.47)	Y N
		Palm Guard Top	2					14V dc Incand. Clear	A	14V dc Incand. Clear	A		
		Palm Guard Bottom	3					28V dc Incand. Clear	B	28V dc Incand. Clear	B		
		Panel Seal and Internal Seal	S					14V LED Red	R	14V LED Red	R		
		Locking Rocker Locks in DOWN Position	G	Black	B	Standard	N	14V LED Green	G	14V LED Green	G		
		Locking Rocker Locks in UP and DOWN Positions	D			High Rated	T	14V LED Amber	Y	14V LED Amber	Y		
		Locking Rocker Locks in UP Position	F			Gold	G	28V LED Red	K	28V LED Red	K		
		Internal Seal	T					28V LED Green	L	28V LED Green	L		
								28V LED Amber	T	28V LED Amber	T		
								28V LED Blue	X	28V LED Blue	X		
		INDICATOR BASE ❷											
		NGRIND						N/A					

❶ Switch Contact Construction Plating

N = Standard (Recommended for use on loads up to 12 Amps @ 14V dc).  
 T = High Rated (Recommended for use on loads greater than 12 Amps @ 14V dc).  
 G = Gold (Recommended for use on dry circuit / low level switching).

❷ See pages 1.48-1.49 to order indicator caps and lenses. To order a complete indicator, see page 1.48.

## STANDARD CIRCUIT DIAGRAMS

Circuit Number	Schematic (Shown in UP Position)	Circuit with Rocker in		
		UP Position	CENTER Position	DOWN Position
<b>SINGLE POLE</b>				
1001		ON	NONE	OFF
		2B-3	—	—
1501		ON	NONE	OFF
		2B-3-9	—	—
1502		ON	NONE	OFF
		2B-3-10	—	—
1503		ON	NONE	OFF
		2B-3	—	—
1504		ON	NONE	OFF
		2B-3	—	—
1505		ON	NONE	OFF
		2B-3-9	—	—
1506		ON	NONE	OFF
		2B-3-10	—	—
1507		ON	NONE	OFF
		2B-3-9-10	—	—
1508		ON	NONE	OFF
		2B-3	—	—
1002		MOM. ON	NONE	OFF
		2B-3	—	—
1521		MOM. ON	NONE	OFF
		2B-3-9	—	—
1522		MOM. ON	NONE	OFF
		2B-3-10	—	—
1523		MOM. ON	NONE	OFF
		2B-3	—	—
1524		MOM. ON	NONE	OFF
		2B-3	—	—

Circuit Number	Schematic (Shown in UP Position)	Circuit with Rocker in		
		UP Position	CENTER Position	DOWN Position
<b>DOUBLE POLE</b>				
2001		ON	NONE	OFF
		2B-3 5B-6	—	—
2501		ON	NONE	OFF
		2B-3-9 5B-6	—	—
2502		ON	NONE	OFF
		2B-3-10 5B-6	—	—
2503		ON	NONE	OFF
		2B-3 5B-6	—	—
2504		ON	NONE	OFF
		2B-3 5B-6	—	—
2505		ON	NONE	OFF
		2B-3-9 5B-6	—	—
2506		ON	NONE	OFF
		2B-3-10 5B-6	—	—
2507		ON	NONE	OFF
		2B-3-9-10 5B-6	—	—
2508		ON	NONE	OFF
		2B-3 5B-6	—	—
2002		MOM. ON	NONE	OFF
		2B-3 5B-6	—	—
2521		MOM. ON	NONE	OFF
		2B-3-9 5B-6	—	—
2522		MOM. ON	NONE	OFF
		2B-3-10 5B-6	—	—
2523		MOM. ON	NONE	OFF
		2B-3 5B-6	—	—
2524		MOM. ON	NONE	OFF
		2B-3 5B-6	—	—

For additional circuit diagrams, contact your local Eaton Sales Representative.

# 1 ROCKER SWITCHES

## New Generation Rocker Switches (continued)

### STANDARD CIRCUIT DIAGRAMS

Circuit Number	Schematic (Shown in UP Position)	Circuit with Rocker in		
		UP Position	CENTER Position	DOWN Position
<b>SINGLE POLE</b>				
1525		MOM. ON	NONE	OFF
		2B-3-9	—	—
1526		MOM. ON	NONE	OFF
		2B-3-10	—	—
1528		MOM. ON	NONE	OFF
		2B-3	—	—
1003		ON	NONE	ON
		2B-3	—	2B-1
1541		ON	NONE	ON
		2B-3-9	—	2B-1
1542		ON	NONE	ON
		2B-3-10	—	2B-1
1543		ON	NONE	ON
		2B-3	—	2B-1
1544		ON	NONE	ON
		2B-3	—	2B-1
1545		ON	NONE	ON
		2B-3-9	—	2B-1
1546		ON	NONE	ON
		2B-3-10	—	2B-1
1547		ON	NONE	ON
		2B-3-9	—	2B-1-10
1548		ON	NONE	ON
		2B-3	—	2B-1
1004		ON	OFF	ON
		2B-3	—	2B-1
1561		ON	OFF	ON
		2B-3-9	—	2B-1

Circuit Number	Schematic (Shown in UP Position)	Circuit with Rocker in		
		UP Position	CENTER Position	DOWN Position
<b>DOUBLE POLE</b>				
2525		MOM. ON	NONE	OFF
		2B-3-9 5B-6	—	—
2526		MOM. ON	NONE	OFF
		2B-3-10 5B-6	—	—
2528		MOM. ON	NONE	OFF
		2B-3 5B-6	—	—
2003		ON	NONE	ON
		2B-3 5B-6	—	2B-1 5B-4
2541		ON	NONE	ON
		2B-3-9 5B-6	—	2B-1 5B-4
2542		ON	NONE	ON
		2B-3-10 5B-6	—	2B-1 5B-4
2543		ON	NONE	ON
		2B-3 5B-6	—	2B-1 5B-4
2544		ON	NONE	ON
		2B-3 5B-6	—	2B-1 5B-4
2545		ON	NONE	ON
		2B-3-9 5B-6	—	2B-1 5B-4
2546		ON	NONE	ON
		2B-3-10 5B-6	—	2B-1 5B-4
2547		ON	NONE	ON
		2B-3-9 5B-6	—	2B-1-10 5B-4
2548		ON	NONE	ON
		2B-3 5B-6	—	2B-1 5B-4
2004		ON	OFF	ON
		2B-3 5B-6	—	2B-1 5B-4
2561		ON	OFF	ON
		2B-3-9 5B-6	—	2B-1 5B-4

For additional circuit diagrams, contact your local Eaton Sales Representative.

## STANDARD CIRCUIT DIAGRAMS

Circuit Number	Schematic (Shown in UP Position)	Circuit with Rocker in		
		UP Position	CENTER Position	DOWN Position
<b>SINGLE POLE</b>				
1562		ON	OFF	ON
		2B-3-10	—	2B-1
1563		ON	OFF	ON
		2B-3	—	2B-1
1564		ON	OFF	ON
		2B-3	—	2B-1
1565		ON	OFF	ON
		2B-3-9	—	2B-1
1566		ON	OFF	ON
		2B-3-10	—	2B-1
1567		ON	OFF	ON
		2B-3-9	—	2B-1-10
1568		ON	OFF	ON
		2B-3	—	2B-1
1005		MOM. ON	OFF	MOM. ON
		2B-3	—	2B-1
1581		MOM. ON	OFF	MOM. ON
		2B-3-9	—	2B-1
1582		MOM. ON	OFF	MOM. ON
		2B-3-10	—	2B-1
1583		MOM. ON	OFF	MOM. ON
		2B-3	—	2B-1
1584		MOM. ON	OFF	MOM. ON
		2B-3	—	2B-1
1585		MOM. ON	OFF	MOM. ON
		2B-3-9	—	2B-1
1586		MOM. ON	OFF	MOM. ON
		2B-3-10	—	2B-1

Circuit Number	Schematic (Shown in UP Position)	Circuit with Rocker in		
		UP Position	CENTER Position	DOWN Position
<b>DOUBLE POLE</b>				
2562		ON	OFF	ON
		2B-3-10 5B-6	—	2B-1 5B-4
2563		ON	OFF	ON
		2B-3 5B-6	—	2B-1 5B-4
2564		ON	OFF	ON
		2B-3 5B-6	—	2B-1 5B-4
2565		ON	OFF	ON
		2B-3-9 5B-6	—	2B-1 5B-4
2566		ON	OFF	ON
		2B-3-10 5B-6	—	2B-1 5B-4
2567		ON	OFF	ON
		2B-3-9 5B-6	—	2B-1-10 5B-4
2568		ON	OFF	ON
		2B-3 5B-6	—	2B-1 5B-4
2005		MOM. ON	OFF	MOM. ON
		2B-3 5B-6	—	2B-1 5B-4
2581		MOM. ON	OFF	MOM. ON
		2B-3-9 5B-6	—	2B-1 5B-4
2582		MOM. ON	OFF	MOM. ON
		2B-3-10 5B-6	—	2B-1 5B-4
2583		MOM. ON	OFF	MOM. ON
		2B-3 5B-6	—	2B-1 5B-4
2584		MOM. ON	OFF	MOM. ON
		2B-3 5B-6	—	2B-1 5B-4
2585		MOM. ON	OFF	MOM. ON
		2B-3-9 5B-6	—	2B-1 5B-4
2586		MOM. ON	OFF	MOM. ON
		2B-3-10 5B-6	—	2B-1 5B-4

For additional circuit diagrams, contact your local Eaton Sales Representative.

# 1 ROCKER SWITCHES

## New Generation Rocker Switches (continued)

### STANDARD CIRCUIT DIAGRAMS

Circuit Number	Schematic (Shown in UP Position)	Circuit with Rocker in		
		UP Position	CENTER Position	DOWN Position
<b>SINGLE POLE</b>				
1587		MOM. ON	OFF	MOM. ON
		2B-3-9	—	2B-1-10
1588		MOM. ON	OFF	MOM. ON
		2B-3	—	2B-1
1006		MOM. ON	OFF	ON
		2B-3	—	2B-1
1601		MOM. ON	OFF	ON
		2B-3-9	—	2B-1
1602		MOM. ON	OFF	ON
		2B-3-10	—	2B-1
1603		MOM. ON	OFF	ON
		2B-3	—	2B-1
1604		MOM. ON	OFF	ON
		2B-3	—	2B-1
1605		MOM. ON	OFF	ON
		2B-3-9	—	2B-1
1606		MOM. ON	OFF	ON
		2B-3-10	—	2B-1
1607		MOM. ON	OFF	ON
		2B-3-9	—	2B-1-10
1608		MOM. ON	OFF	ON
		2B-3	—	2B-1
3003 ②		ON	ON	OFF
		2B-3	2A-2B	—
3541 ②		ON	ON	OFF
		2B-3	2A-2B	—
3542 ②		ON	ON	OFF
		2B-3	2A-2B	—

Circuit Number	Schematic (Shown in UP Position)	Circuit with Rocker in		
		UP Position	CENTER Position	DOWN Position
<b>DOUBLE POLE</b>				
2587		MOM. ON	OFF	MOM. ON
		2B-3-9 5B-6	—	2B-1-10 5B-4
2588		MOM. ON	OFF	MOM. ON
		2B-3 5B-6	—	2B-1 5B-4
2006		MOM. ON	OFF	ON
		2B-3 5B-6	—	2B-1 5B-4
2601		MOM. ON	OFF	ON
		2B-3-9 5B-6	—	2B-1 5B-4
2602		MOM. ON	OFF	ON
		2B-3-10 5B-6	—	2B-1 5B-4
2603		MOM. ON	OFF	ON
		2B-3 5B-6	—	2B-1 5B-4
2604		MOM. ON	OFF	ON
		2B-3 5B-6	—	2B-1 5B-4
2605		MOM. ON	OFF	ON
		2B-3-9 5B-6	—	2B-1 5B-4
2606		MOM. ON	OFF	ON
		2B-3-10 5B-6	—	2B-1 5B-4
2607		MOM. ON	OFF	ON
		2B-3-9 5B-6	—	2B-1-10 5B-4
2608		MOM. ON	OFF	ON
		2B-3 5B-6	—	2B-1 5B-4
3004 ②		ON	ON	OFF
		2B-3 5B-6	2A-2B 5A-5B	—
3561 ②		ON	ON	OFF
		2B-3-9 5B-6	2A-2B 5A-5B	—
3562 ②		ON	ON	OFF
		2B-3 5B-6	2A-2B 5A-5B	—

① For additional circuit diagrams, contact your local Eaton Sales Representative.  
 ② Schematics shown in "CENTER" position.

## STANDARD CIRCUIT DIAGRAMS

Circuit Number	Schematic (Shown in UP Position)	Circuit with Rocker in		
		UP Position	CENTER Position	DOWN Position
<b>DOUBLE POLE</b>				
3001		ON	ON	ON
		2B-3 5B-6	5B-4 2B-3	5B-4 2B-1
3501		ON	ON	ON
		2B-3-9 5B-6	5B-4 2B-3-9	5B-4 2B-1
3502		ON	ON	ON
		2B-3-10 5B-6	5B-4 2B-3	5B-4 2B-1
3503		ON	ON	ON
		2B-3 5B-6	5B-4 2B-3	5B-4 2B-1

Circuit Number	Schematic (Shown in UP Position)	Circuit with Rocker in		
		UP Position	CENTER Position	DOWN Position
<b>DOUBLE POLE</b>				
3002		2 – ON	1 – ON	OFF
		2B-3 5B-6	2B-3 5B-4	2B-1 5B-4
3521		2 – ON	1 – ON	OFF
		2B-3 5B-6	2B-3 5B-4	2B-1 5B-4
3522		2 – ON	1 – ON	OFF
		2B-3 5B-6	2B-3 5B-4	2B-1 5B-4
3523		2 – ON	1 – ON	OFF
		2B-3 5B-6	2B-3 5B-4	2B-1 5B-4

## EURO-STANDARD CIRCUIT DIAGRAMS

Circuit Number	Schematic (Shown in DOWN Position)	Circuit with Rocker in		
		UP Position	CENTER Position	DOWN Position
<b>SINGLE POLE</b>				
5001		OFF	NONE	ON
		—	—	2B-1
5501		OFF	NONE	ON
		—	—	2B-1-9
5502		OFF	NONE	ON
		—	—	2B-1-10
5503		OFF	NONE	ON
		—	—	2B-1
5504		OFF	NONE	ON
		—	—	2B-1
5505		OFF	NONE	ON
		—	—	2B-1-9
5506		OFF	NONE	ON
		—	—	2B-1-10
5508		OFF	NONE	ON
		—	—	2B-1

Circuit Number	Schematic (Shown in DOWN Position)	Circuit with Rocker in		
		UP Position	CENTER Position	DOWN Position
<b>SINGLE POLE</b>				
5002		OFF	NONE	MOM. ON
		—	—	2B-1
5521		OFF	NONE	MOM. ON
		—	—	2B-1-9
5522		OFF	NONE	MOM. ON
		—	—	2B-1-10
5523		OFF	NONE	MOM. ON
		—	—	2B-1
5524		OFF	NONE	MOM. ON
		—	—	2B-1
5525		OFF	NONE	MOM. ON
		—	—	2B-1-9
5526		OFF	NONE	MOM. ON
		—	—	2B-1-10
5528		OFF	NONE	MOM. ON
		—	—	2B-1

1 For additional circuit diagrams, contact your local Eaton Sales Representative.



# 1 ROCKER SWITCHES

## New Generation Rocker Switches (continued) Rocker Button/Actuator

### HOW TO ORDER — ROCKER BUTTON/ACTUATOR

To determine your **Complete Catalog Number**, you must start with the appropriate **Rocker Button Type** and add the appropriate **Code Letters and/or Numbers** as in the examples below:

Add each appropriate Number or Letter...											...to get to your Complete Catalog Number
Rocker Button Type	Icon Location	Icon "A"	Icon "A" Orientation	Icon "A" Color	Icon "A" Lighted Color or Lens Color	Icon "B"	Icon "B" Orientation	Icon "B" Color	Icon "B" Lighted Color or Lens Color	Indicator Stripe Location	Complete Catalog Number
2	A	AA	A	3	B	—	—	—	—	2	2AAAA3B2
3	C	AF	A	1	B	AE	A	2	A	0	3CAFA1BAEA2A0

### ROCKER BUTTON / ACTUATOR SELECTION TABLE

CODE LETTERS AND NUMBERS											
Rocker Button Type		Icon Location		Icon "A"	Icon "A" Orientation		Icon "A" Color		Icon "A" Lighted Color or Lens Color		
Type	Code	Location	Code	Code	Orientation	Code	Color	Code	Color	Code	
<b>ICON A</b>											
Two Face No Lens Rocker	1						No Icon – No Color	0			
Two Face "SIL" Rocker (Snap-in Lens)	2	"A" Icon Only	A	See icon selection table on pages 1.50-1.51	Standard Orientation	A	Daylight White (Decorative Rocker Only)	1	Red	A	
Decorative Rocker (Back-lit)	3		B		90° Clockwise	B	Dead Front (Decorative Rocker Only)	2	Green	B	
Decorative Paddle (Back-lit)	4		C		180° Clockwise	C	White (Two Face Rocker Only)	3	Amber	C	
Locking Rocker	5		D		270° Clockwise	D	Black (Two Face Rocker Only)	4	Blue	E	
Label Rocker	6				No Icon – No Orientation	O	White (Two Face Rocker Only)	3	Clear	F	
									Black (Two Face Rocker Only)	4	Non-lighted or No Lens
							Lens Hole (No Lens)	5			

NOTE: Pad printed legends on the decorative rocker or paddle are not available.

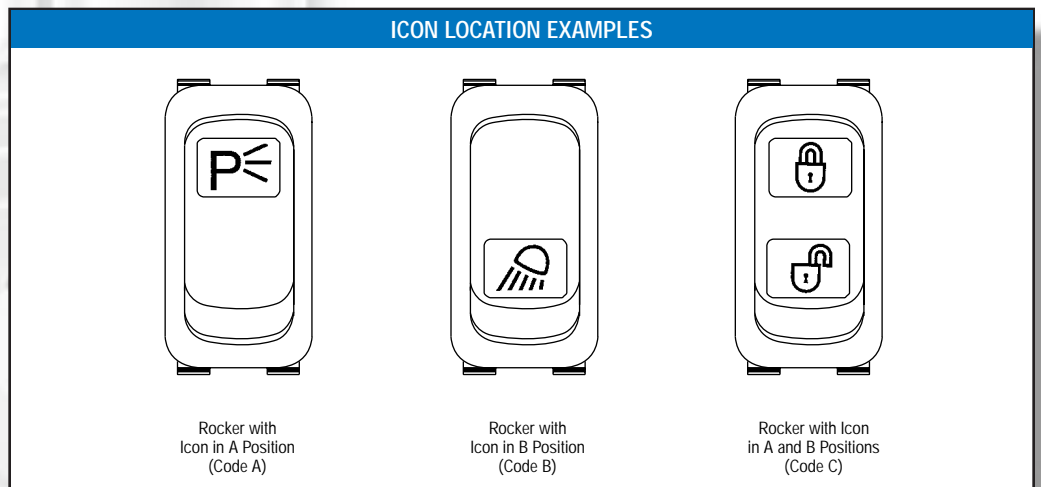



**ROCKER BUTTON / ACTUATOR SELECTION TABLE (continued)**

CODE LETTERS AND NUMBERS									
Icon "B"	Icon "B" Orientation		Icon "B" Color		Icon "B" Lighted Color or Lens Color		Indicator Stripe Location		
Code	Orientation	Code	Color	Code	Color	Code	Location	Code	
<b>ICON B</b>									
See icon selection table on pages 1.50-1.51			No Icon – No Color	0					
		Standard Orientation	Daylight White (Decorative Rocker Only)	1	Red	A	A Position B Position A and B Positions No Stripe	1 2 3 0	
		90° Clockwise	Dead Front (Decorative Rocker Only)	2	Green	B			
		180° Clockwise	White (Two Face Rocker Only)	3	Amber	C			
		270° Clockwise	Black (Two Face Rocker Only)	4	Blue	E			
		No Icon – No Orientation	Lens Hole (No Lens)	5	White	F			
					Clear	G			
				Non-lighted or No lens	O				

NOTE: Pad printed legends on the decorative rocker or paddle are not available.

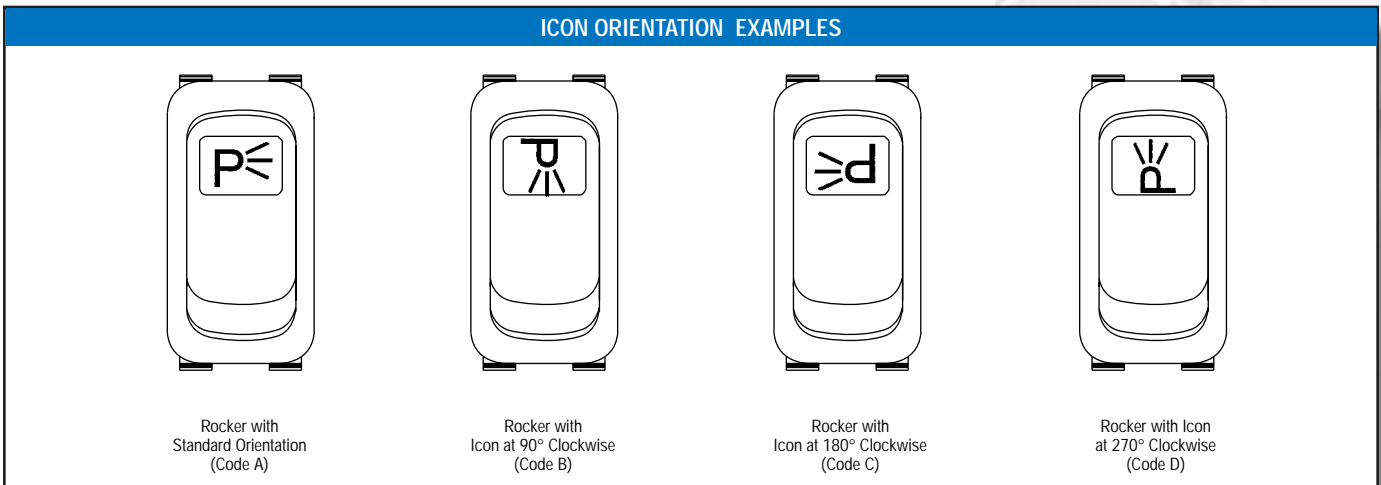

# 1 ROCKER SWITCHES

## New Generation Rocker Switches (continued) Indicator & Lens

### HOW TO ORDER — NGR COMPLETE INDICATOR

To determine your **Complete Catalog Number**, you must start with the appropriate **Indicator Type** and add the appropriate **Code Letters** and/or **Numbers** as in the examples below:

Select each appropriate Number or Letter...										...to get to your Complete Catalog Number
Indicator Type	Icon Location	Icon "A"	Lamp/LED Type and Color	Icon "A" Color	Icon "A" Lighted Color or Lens Color	Icon "B"	Lamp/LED Type and Color	Icon "B" Color	Icon "B" Lighted Color or Lens Color	Complete Catalog Number
3N	B	—	—	—	—	AA	A	3	A	3NBAAA3A
2N	C	AA	A	3	A	BB	A	3	A	2NCAA3ABBA3A

### NGR COMPLETE INDICATOR SELECTION TABLE

CODE LETTERS AND NUMBERS																		
Indicator Type		Icon Location		Icon "A"	Lamp/Led Type and Color		Icon "A" Color		Icon "A" Lighted Color or Lens Color		Icon "B"	Lamp/LED Type and Color		Icon "B" Color		Icon "B" Lighted Color or Lens Color		
Style	Code	Location	Code	Code	Type and Color	Code	Type and Color	Code	Color	Code	Code	Color	Code	Type and Color	Code	Color	Code	
Two Face "SIL" (Snap-in Lens) Laser - Etched Label	2N 3N 6N	"A" Icon Only "B" Icon Only "A" and "B" Icons No Icon	A B C D	See icon table on pages 1.50-1.51	14V dc Incand. Clear	A	No Icon-No Color	0					14V dc Incand. Clear	A	No Icon-No Color	0		
					28V dc Incand. Clear	B	Daylight White	1	Red	A	No Lamp/LED	O	Daylight White	1	Red	A		
					No Lamp/LED	O	Dead Front (Decorative Rocker Only)	2	Green	B	14V LED Red	R	Dead Front (Decorative Rocker Only)	2	Green	B		
					14V LED Red	R	White (Two Face Rocker Only)	3	Blue	E	14V LED Green	G	White (Two Face Rocker Only)	3	Blue	E		
					14V LED Green	G	Black (Two Face Rocker Only)	4	Clear	G	14V LED Amber	Y	Black (Two Face Rocker Only)	4	Clear	G		
					14V LED Amber	Y	Lens Hole (No Lens)	5			14V LED Amber	Y	Lens Hole (No Lens)	5				
					28V LED Red	K					28V LED Red	K						
					28V LED Green	L					28V LED Green	L						
					28V LED Amber	T					28V LED Amber	T						

To order indicator base only, see page 1.40.

To order indicator cap only, see page 1.49.

### HOW TO ORDER — LENS (See table on page 1.49 for lens selection)

To determine your **Complete Catalog Number**, you must start with the appropriate **Base Catalog Number** and add the appropriate **Code Letters** and/or **Numbers** as in the example below:

Add each appropriate Number or Letter...			...to get to your Complete Catalog Number
Base Catalog Number	Icon	Orientation	Complete Catalog Number
28-5863-2	AA	A	28-5863-2AAA

See Table On Page 1.49

## HOW TO ORDER — INDICATOR CAP

To determine your **Complete Catalog Number**, you must start with the appropriate **Indicator Type** and add the appropriate **Code Letters** and/or **Numbers** as in the examples below:

Select each appropriate Number or Letter...								...to get to your Complete Catalog Number
Indicator Type	Icon Location	Icon "A"	Icon "A" Color	Icon "A" Lighted or Lens Color	Icon "B"	Icon "B" Color	Icon "B" Lighted or Lens Color	Complete Catalog Number
3CAP	A	BB	1	C	—	—	—	3CAPABB1C
3CAP	C	BB	1	C	AA	1	B	3CAPCBB1CAA1B

## INDICATOR CAP SELECTION TABLE (To order Indicator Base, see page 1.40)

CODE LETTERS AND NUMBERS																								
Indicator Type		Icon Location		Icon "A"	Icon "A" Color		Icon "A" Lighted Color or Lens Color		Icon "B"	Icon "B" Color		Icon "B" Lighted Color or Lens Color												
Style	Code	Location	Code	Code	Type and Color	Code	Color	Code	Code	Type and Color	Code	Color	Code											
Two Face "SIL" (Snap-in Lens)	2CAP	"A" Icon Only	A	See icon table on pages 1.50-1.51	No Icon- No Color	0	Red Green Amber Blue White Clear	A B C E F G	See icon table on pages 1.50-1.51	No Icon- No Color	0	Red Green Amber Blue White Clear	A B C E F G											
					Daylight White	1				Daylight White	1													
	Decorative Laser – Etched	3CAP	"B" Icon Only		B	Dead Front ❶ (Decorative Rocker Only)				2	White Black ❷ (Two Face Rocker Only)			F G	See icon table on pages 1.50-1.51	Dead Front ❶ (Decorative Rocker Only)	2	White Black ❷ (Two Face Rocker Only)	F G					
						White ❷ (Two Face Rocker Only)				3						White ❷ (Two Face Rocker Only)	3							
	Label	6CAP	"A" and "B" Icons		C	Black ❷ (Two Face Rocker Only)				4						Lens Hole (No Lens)				See icon table on pages 1.50-1.51	Black ❷ (Two Face Rocker Only)	4	Lens Hole (No Lens)	
						No Icon				D											Lens Hole (No Lens)	5		

- ❶ Decorative rocker only.
- ❷ Two face rocker only.

## LENS SELECTION TABLE ❶ (For NGR Rocker Type "2" and Indicator Type "2CAP" only)

CODE LETTERS AND NUMBERS				
Lens		Icon	Orientation	
Color	Catalog Number	Code	Style	Code
<b>TRANSLUCENT LENSES</b>				
Red	28-5863-2	See Icon Selection Table on pages 1.50-1.51	Standard	A
Green	28-5863		Rotated 90° Clockwise	B
Amber	28-5863-3		Inverted 180°	C
Blue	28-5863-9		Rotated 270° Clockwise	D
<b>TRANSPARENT LENSES</b>				
Red	28-5863-5	See Icon Selection Table on pages 1.50-1.51	Standard	A
Green	28-5863-4		Rotated 90° Clockwise	B
Amber	28-5863-6		Inverted 180°	C
Blue	28-5863-10		Rotated 270° Clockwise	D













































❶ When ordering a lens with an icon for the code B (bottom) position, specify code C orientation.

# 1 ROCKER SWITCHES

## New Generation Rocker Switches (continued)

STANDARD BACK-LIT LEGENDS/ICONS — Reference SAE Specification No. J1362<sup>1</sup>

Icon	Description	Code	Icon	Description	Code	Icon	Description	Code
	Horn	AA		Dehumidifier	AR		Turn Signals	BH
	Battery	AB		Headlights – Low/Dipped Beam	AS		Clearance/ Position Lights	BI
	Fast	AC		Work Light	AT		Turn Signal	BJ
	Slow	AD		Parking Light	AU		Rear Windshield Wiper	BK
	Lock	AE		Hazard Lights	AV		Heated Mirror	BL
	Unlock	AF		Headlights – High/Upper Beam	AW		Seat Adjustment– Up	BM
	Engine – Stop	AG		Rear Window Demister/Defroster	AX		Seat Adjustment– Down	BN
	Fuel	AH		Rear Fog Lights	AY	<b>3</b>	Third Gear	BP
	Master Lighting Switch	AJ		Front Fog Lights	BA	<b>1</b>	First Gear	BQ
	Windshield – Wiper	AK		Interior Dome Lights	BB		Beacon	BR
	Windshield – Washer	AL		Electrical Power Accessories	BC		PTO	BS
	Windshield – Washer and Wiper	AM		Radio	BD		Differential Lock	BT
	Windshield – Demister/Defroster	AN		Indicator Bar	BE		Rockshaft – Up	BU
	Air Conditioning/ Cooling System	AP		Engine – Electrical	BF		Rockshaft – Down	BV
	Ventilating/ Air Circulating Fan	AQ		Engine – Gas Injection	BG		Auxillary Drive – Up	BW

<sup>1</sup> Additional icons are available. Contact your local Eaton Sales Representative.

STANDARD BACK-LIT LEGENDS/ICONS — Reference SAE Specification No. J1362<sup>1</sup>

Icon	Description	Code	Icon	Description	Code	Icon	Description	Code
	Auxiliary Drive – Down	BX		All Wheel Drive	CW		Door Open	EB
	Rear Window Washer	BZ		Off	DM		Door Close	EC
	Entry Step	CA		Engine – Diesel Preheat	DN		Baggage Area Light	ED
	Engine Brake	CB		Heated Seat	DP		Refreshments	EE
	Engine Brake 3 Stage	CC		Heated Mirror	DQ	<b>SET</b>	Set	EF
	Engine Brake 2 Stage	XX		Driver's Light	DR	<b>RESUME</b>	Resume	EG
	Select Idle	CE		Driver's Fan	DS	<b>ETHER</b>	Ether	EH
	Heater	CF		Ramp In	DT		Engine Fan	EI
<b>CRUISE</b>	Cruise	CL		Ramp Out	DU		Baggage Lock	EJ
	Parking Brake	CP		Kneel Up	DV		Baggage Unlock	EK
	Alarm	CQ		Kneel Down	DW		Disabled	EL
	Retarder	CR	<b>START</b>	Start	DX		Door Locked	EM
	Heated Seat	CS	<b>STOP</b>	Stop	DY		Door Unlocked	EN
	Rear Alarm Cancel	CT		ABS Brake	DZ	<b>B/U CAMERA</b>	B/U Camera	EO
	Window Lift	CU		Kneel	EA		Cabin Ventilation	EP

1

<sup>1</sup> Additional icons are available. Contact your local Eaton Sales Representative.

# 1 ROCKER SWITCHES

## New Generation Rocker Switches (continued)

DIMENSIONS APPROXIMATE IN MM (INCHES)

### SWITCH BASE WITH ROCKER BUTTON

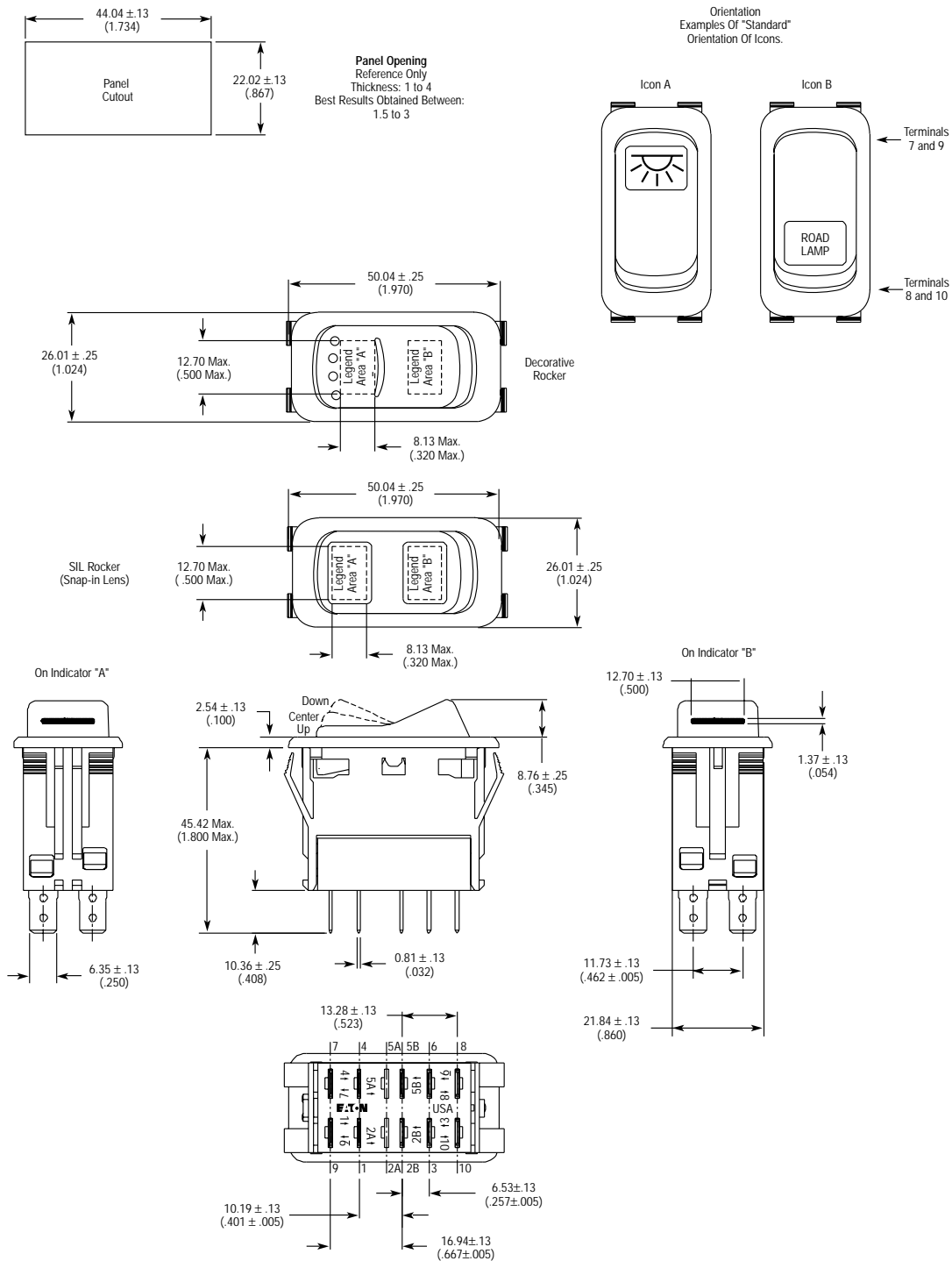

**DIMENSIONS** APPROXIMATE IN MM (INCHES)

1

