

Data sheet | Item number: 2857-570/024-001

3-Phase Power Measurement Module; 3x400/690 V/1 A; Modbus RTU;
Digital output; Configuration via software; Supply voltage: 24 VDC

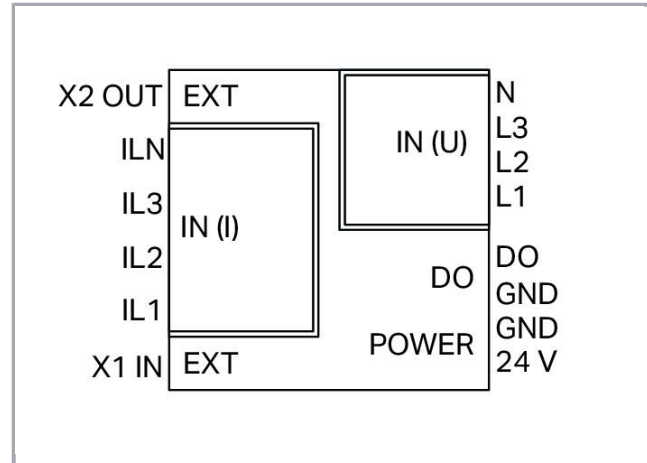

www.wago.com/2857-570/024-001

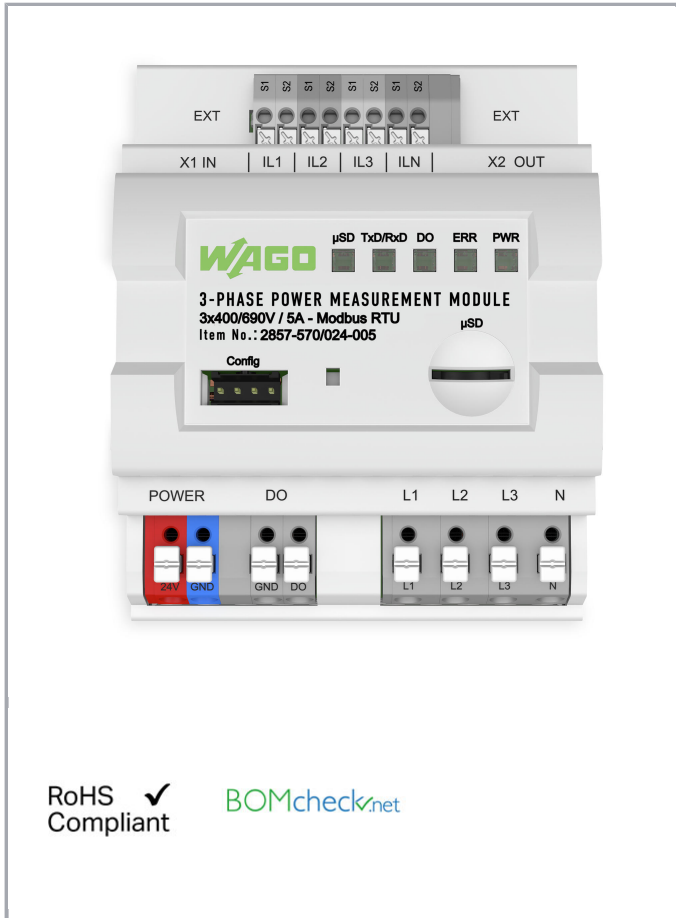

Item description

Short description:

WAGO's 3-phase power measurement module in a DIN-railmount enclosure measures electrical data in three-phase supply networks – remotely from the control level.

Measured variables such as active/apparent/reactive power, energy consumption, power factor, phase angle and frequency can be accessed via Modbus[®] Interface. In addition, the measured variables can be stored on a microSD card.

Features:

- Current measurement via 1A current transformer
- Mobile measurement and storage of measured values on microSD card
- Configuration and display of measured values during operation via configuration interface

Subject to changes. Please also observe the further product documentation!

WAGO Kontakttechnik GmbH & Co. KG
Hansastr. 27
32423 Minden
Phone: +49571 887-0 | Fax: +49571 887-169
Email: info.de@wago.com | Web: www.wago.com

Do you have any questions about our products?
We are always happy to take your call at +49 (571) 887-44222.



- Compact device in DIN-rail-mount enclosure saves space used for building technology
- Communication of measured values via Modbus[®] Interface
- Configurable digital signal output as pulse output

Note:

- Additional setting options via interface configuration software
- In the present network, ensure that the neutral conductor is not dangerously active!

Data**Technical Data****Configuration**

Configuration options	WAGO interface configuration software
-----------------------	---------------------------------------

Input

Input signal type	Voltage Electricity
Network configuration	3-phase power measurement with N-conductor (4-conductor) 3-phase power measurement without N-conductor (3-conductor)
Input signal (voltage)	AC 400 V (U_{LN}); AC 690 V (U_{LL})
Input signal (current)	AC 1 A; (Current transformer)
Frequency range	45 ... 65 Hz (Harmonics analysis: 0 ... 3.3 kHz)
Input resistance (current input)	22 m Ω
Input resistance (voltage input)	1.5 M Ω
Input current (max.)	1 AAC
Input voltage (max.)	400 VAC (U_{LN}); 690 VAC (U_{LL})
Response threshold	10 mA
Resolution (current)	10 mA

Output – Digital

Switching voltage (DO) (max.)	Supply voltage (applied)
Continuous current (DO) (max.)	100 mA (no internal restriction)
Configurable functions (DO)	Threshold value switch Pulse output (S0 interface)

Subject to changes. Please also observe the further product documentation!



Communication

Communication	Modbus RTU
Interface	RS-485 (2-wire) via RJ-45
Number of devices (max.)	32
Addressing	Via Interface configuration software

Signal processing

Measurement method	True RMS measurement (measured value acquisition with 8 kHz)
Measured variables (calculated)	Line-to-line voltage Outputs Energy sources Power factors Mains frequency Harmonics analysis (up to 41st harmonic) Total harmonic distortion (THD)
Signal form	Any periodic signals (considering the threshold frequencies)
Limit frequency	15,9 kHz
Memory card type	WAGO 758-879/000-3102 (microSD; 2 GB)

Measurement error

Transmission error (max.)	≤ 0.5 % for current and voltage (of the full scale value)
---------------------------	---

Power supply

Power supply type	24 VDC
Nominal supply voltage U_S	DC 24 V (SELV)
Supply voltage range	±30 %
Power consumption at nominal supply voltage	≤ 50 mA (+ I_{D0})

Safety and protection:

Test voltage (input/output/supply)	AC 3,51 kV; 50 Hz; 1 min
Overvoltage category	III
Pollution degree	2
Safe isolation	Input/supply and communication per EN 61010-1
Requirement (N input)	Shall not be dangerously active
Requirement (I_{L_x} input)	Coils/converters with basic insulation

Subject to changes. Please also observe the further product documentation!



Protection type	IP20
-----------------	------

Connection data

Connection type (1)	Voltage
Connection technology	Push-in CAGE CLAMP®
WAGO Connector	WAGO 804 Series
Solid conductor	0,25 ... 2,5 mm ² / 20 ... 12 AWG
Fine-stranded conductor	0,25 ... 2,5 mm ² / 22 ... 12 AWG
Strip length	10 ... 11 mm / 0.39 ... 0.43 inch
Connection type 2	Current/Power supply/DO
Connection technology 2	Push-in CAGE CLAMP®
WAGO Connector 2	WAGO 805 Series
Solid conductor 2	0,2 ... 1,5 mm ² / 24 ... 16 AWG
Fine-stranded conductor 2	0,2 ... 1,5 mm ² / 24 ... 16 AWG
Strip length 2	9 ... 10 mm / 0.35 ... 0.39 inch
Connection type (3)	Modbus® communication
Pluggable connectors	2 x RJ-45 (daisy chain configuration)

Geometrical Data

Width	72 mm / 2.835 inch
Height from upper-edge of DIN-rail	55 mm / 2.165 inch
Depth	90 mm / 3.54 inch

Mechanical data

Mounting type	DIN-35 rail
---------------	-------------

Material Data

Weight	117.5 g
--------	---------

Environmental Requirements

Surrounding air temperature (operation)	-40 ... 70 °C
Surrounding air temperature (storage)	-40 ... 85 °C
Relative humidity	5 ... 95 % (non-condensing)

Subject to changes. Please also observe the further product documentation!

Standards and specifications

Conformity marking	CE
EMC immunity to interference	EN 61000-6-2
EMC emission of interference	EN 61000-6-3
Standards/specifications	EN 61010-1

Commercial data

Packaging type	BOX
Country of origin	DE
GTIN	4055143827539
Customs tariff number	85437090300

Approvals / Certificates

Ship Approvals

Logo	Approval	Additional Approval Text	Certificate name
	DNV GL Det Norske Veritas, Germanischer Lloyd	-	TAA00001ZY

Counterpart

Compatible products

memory card



Item no.: 758-879/000-3102
Memory Card SD Micro; 2 GByte

www.wago.com/758-879/000-3102

power supply

Subject to changes. Please also observe the further product documentation!

WAGO Kontakttechnik GmbH & Co. KG
Hansastr. 27
32423 Minden
Phone: +49571 887-0 | Fax: +49571 887-169
Email: info.de@wago.com | Web: www.wago.com

Do you have any questions about our products?
We are always happy to take your call at +49 (571) 887-44222.



Item no.: 787-2850

Switched-mode power supply; Compact; 1-phase; 24 VDC output voltage; 1.25 A output current

www.wago.com/787-2850

potential distribution



Item no.: 855-1851/350-000

Current and voltage tap up to 185 mm²; Primary rated current: 350 A; Secondary rated current: 1 A; Rated power: 0.2 VA; Accuracy class: 0.5; fused

www.wago.com/855-1851/350-000



Item no.: 855-501/150-000

Current and voltage tap up to 50 mm²; Primary rated current: 150 A; Secondary rated current: 1 A; Rated power: 0.2 VA; Accuracy class: 0.5; fused

www.wago.com/855-501/150-000



Item no.: 855-951/250-000

Current and voltage tap up to 95 mm²; Primary rated current: 250 A; Secondary rated current: 1 A; Rated power: 0.2 VA; Accuracy class: 0.5; fused

www.wago.com/855-951/250-000

wiring and connectors



Item no.: 750-923

Configuration cable; USB connector; Length: 2.5 m; black

www.wago.com/750-923



Item no.: 750-923/000-001

Configuration cable; USB connector; Length: 5 m

www.wago.com/750-923/000-001



Item no.: 750-978/000-011

Connector ETHERNET; RJ-45; Cat. 6A; straight; Code T568A; AWG 22; Strain relief

www.wago.com/750-978/000-011

General accessories



Item no.: 2007-8874

Compact terminal block; for current and voltage transformers; 6,00 mm²; multicoloured

www.wago.com/2007-8874



Item no.: 2007-8877

Compact terminal block; for current transformer circuit; 6,00 mm²; multicoloured

www.wago.com/2007-8877



Item no.: 855-8001

Power tap; with fuse; 2,5 mm² (12 AWG) - 6 mm² (10 AWG); Phase

www.wago.com/855-8001



Item no.: 855-8002

Power tap; without fuse; 2,5 mm² (12 AWG) - 6 mm² (10 AWG); N-conductor

www.wago.com/855-8002



Item no.: 855-8003

Power tap; with fuse; 10 mm² (8 AWG) - 16 mm² (6 AWG); Phase

www.wago.com/855-8003



Item no.: 855-8004

Power tap; without fuse; 10 mm² (8 AWG) - 16 mm² (6 AWG); N-conductor

www.wago.com/855-8004



Item no.: 855-8006

Power tap; for busbar; with fuse; Mounting screw M6

www.wago.com/855-8006



Item no.: 855-8008

Power tap; for busbar; with fuse; Mounting screw M8

www.wago.com/855-8008

Subject to changes. Please also observe the further product documentation!

WAGO Kontakttechnik GmbH & Co. KG

Hansastr. 27

32423 Minden

Phone: +49571 887-0 | Fax: +49571 887-169

Email: info.de@wago.com | Web: www.wago.com

Do you have any questions about our products?

We are always happy to take your call at +49 (571) 887-44222.

**Item no.: 855-8015**

Power tap; for busbar; with fuse; Clamping connection

www.wago.com/855-8015**current transformer****Item no.: 855-1001/2500-1001**

Plug-in current transformer; Primary rated current: 2500 A; Secondary rated current: 1 A; Rated power: 10 VA; Accuracy class: 1

www.wago.com/855-1001/2500-1001**Item no.: 855-2701/035-001**

Plug-in current transformer; Primary rated current: 35 A; Secondary rated current: 1 A; Rated power: 0.2 VA; Accuracy class: 1

www.wago.com/855-2701/035-001**Item no.: 855-2701/064-001**

Plug-in current transformer; Primary rated current: 64 A; Secondary rated current: 1 A; Rated power: 0.2 VA; Accuracy class: 1

www.wago.com/855-2701/064-001**Item no.: 855-3001/060-003**

Split-core current transformer; Primary rated current: 60 A; Secondary rated current: 1 A; Rated power: 0.2 VA; Accuracy class: 3; Cable length: 3 m

www.wago.com/855-3001/060-003**Item no.: 855-3001/100-003**

Split-core current transformer; Primary rated current: 100 A; Secondary rated current: 1 A; Rated power: 0.2 VA; Accuracy class: 3; Cable length: 3 m

www.wago.com/855-3001/100-003**Item no.: 855-3001/200-001**

Split-core current transformer; Primary rated current: 200 A; Secondary rated current: 1 A; Rated power: 0.2 VA; Accuracy class: 1; Cable length: 3 m

www.wago.com/855-3001/200-001**Item no.: 855-3001/250-001**

Split-core current transformer; Primary rated current: 250 A; Secondary rated current: 1 A; Rated power: 0.2 VA; Accuracy class: 1; Cable length: 3 m

www.wago.com/855-3001/250-001**Item no.: 855-301/050-103**

Plug-in current transformer; Primary rated current: 50 A; Secondary rated current: 1 A; Rated power: 1.25 VA; Accuracy class: 3

www.wago.com/855-301/050-103**Item no.: 855-301/060-101**

Plug-in current transformer; Primary rated current: 60 A; Secondary rated current: 1 A; Rated power: 1.25 VA; Accuracy class: 1

www.wago.com/855-301/060-101**Item no.: 855-301/075-201**

Plug-in current transformer; Primary rated current: 75 A; Secondary rated current: 1 A; Rated power: 2.5 VA; Accuracy class: 1

www.wago.com/855-301/075-201**Item no.: 855-301/100-201**

Plug-in current transformer; Primary rated current: 100 A; Secondary rated current: 1 A; Rated power: 2.5 VA; Accuracy class: 1

www.wago.com/855-301/100-201**Item no.: 855-301/150-501**

Plug-in current transformer; Primary rated current: 150 A; Secondary rated current: 1 A; Rated power: 5 VA; Accuracy class: 1

www.wago.com/855-301/150-501**Item no.: 855-301/200-501**

Subject to changes. Please also observe the further product documentation!

WAGO Kontakttechnik GmbH & Co. KG

Hansastr. 27













32423 Minden

Phone: +49571 887-0 | Fax: +49571 887-169













Email: info.de@wago.com | Web: www.wago.com

Do you have any questions about our products?

We are always happy to take your call at +49 (571) 887-44222.

	Plug-in current transformer; Primary rated current: 200 A; Secondary rated current: 1 A; Rated power: 5 VA; Accuracy class: 1	www.wago.com/855-301/200-501
	Item no.: 855-301/250-501 Plug-in current transformer; Primary rated current: 250 A; Secondary rated current: 1 A; Rated power: 5 VA; Accuracy class: 1	www.wago.com/855-301/250-501
	Item no.: 855-301/400-1001 Plug-in current transformer; Primary rated current: 400 A; Secondary rated current: 1 A; Rated power: 10 VA; Accuracy class: 1	www.wago.com/855-301/400-1001
	Item no.: 855-301/600-1001 Plug-in current transformer; Primary rated current: 600 A; Secondary rated current: 1 A; Rated power: 10 VA; Accuracy class: 1	www.wago.com/855-301/600-1001
	Item no.: 855-4001/100-001 Split-core current transformer; Primary rated current: 100 A; Secondary rated current: 1 A; Rated power: 0.2 VA; Accuracy class: 1; Cable length: 3 m	www.wago.com/855-4001/100-001
	Item no.: 855-4001/150-001 Split-core current transformer; Primary rated current: 150 A; Secondary rated current: 1 A; Rated power: 0.2 VA; Accuracy class: 1; Cable length: 3 m	www.wago.com/855-4001/150-001
	Item no.: 855-4001/200-001 Split-core current transformer; Primary rated current: 200 A; Secondary rated current: 1 A; Rated power: 0.2 VA; Accuracy class: 1; Cable length: 3 m	www.wago.com/855-4001/200-001
	Item no.: 855-401/250-501 Plug-in current transformer; Primary rated current: 250 A; Secondary rated current: 1 A; Rated power: 5 VA; Accuracy class: 1	www.wago.com/855-401/250-501
	Item no.: 855-401/400-501 Plug-in current transformer; Primary rated current: 400 A; Secondary rated current: 1 A; Rated power: 5 VA; Accuracy class: 1	www.wago.com/855-401/400-501
	Item no.: 855-401/600-501 Plug-in current transformer; Primary rated current: 600 A; Secondary rated current: 1 A; Rated power: 10 VA; Accuracy class: 1	www.wago.com/855-401/600-501
	Item no.: 855-4101/200-001 Split-core current transformer; Primary rated current: 200 A; Secondary rated current: 1 A; Rated power: 0.2 VA; Accuracy class: 1; Cable length: 3 m	www.wago.com/855-4101/200-001
	Item no.: 855-4101/250-001 Split-core current transformer; Primary rated current: 250 A; Secondary rated current: 1 A; Rated power: 0.2 VA; Accuracy class: 1; Cable length: 3 m	www.wago.com/855-4101/250-001
	Item no.: 855-4101/400-001 Split-core current transformer; Primary rated current: 400 A; Secondary rated current: 1 A; Rated power: 0.2 VA; Accuracy class: 1; Cable length: 3 m	www.wago.com/855-4101/400-001
	Item no.: 855-5001/1000-000	

Subject to changes. Please also observe the further product documentation!

	Split-core current transformer; Primary rated current: 1000 A; Secondary rated current: 1 A; Rated power: 0.5 VA; Accuracy class: 0.5; Cable length: 5 m	www.wago.com/855-5001/1000-000
	Item no.: 855-5001/250-001 Split-core current transformer; Primary rated current: 250 A; Secondary rated current: 1 A; Rated power: 0.5 VA; Accuracy class: 1; Cable length: 5 m	www.wago.com/855-5001/250-001
	Item no.: 855-5001/400-000 Split-core current transformer; Primary rated current: 400 A; Secondary rated current: 1 A; Rated power: 0.5 VA; Accuracy class: 0.5; Cable length: 5 m	www.wago.com/855-5001/400-000
	Item no.: 855-5001/600-000 Split-core current transformer; Primary rated current: 600 A; Secondary rated current: 1 A; Rated power: 0.5 VA; Accuracy class: 0.5; Cable length: 5 m	www.wago.com/855-5001/600-000
	Item no.: 855-501/1000-1001 Plug-in current transformer; Primary rated current: 1000 A; Secondary rated current: 1 A; Rated power: 10 VA; Accuracy class: 1	www.wago.com/855-501/1000-1001
	Item no.: 855-501/400-1001 Plug-in current transformer; Primary rated current: 400 A; Secondary rated current: 1 A; Rated power: 10 VA; Accuracy class: 1	www.wago.com/855-501/400-1001
	Item no.: 855-501/600-1001 Plug-in current transformer; Primary rated current: 600 A; Secondary rated current: 1 A; Rated power: 10 VA; Accuracy class: 1	www.wago.com/855-501/600-1001
	Item no.: 855-501/800-1001 Plug-in current transformer; Primary rated current: 800 A; Secondary rated current: 1 A; Rated power: 10 VA; Accuracy class: 1	www.wago.com/855-501/800-1001
	Item no.: 855-5101/1000-000 Split-core current transformer; Primary rated current: 1000 A; Secondary rated current: 1 A; Rated power: 0.5 VA; Accuracy class: 0.5; Cable length: 5 m	www.wago.com/855-5101/1000-000
	Item no.: 855-601/1500-501 Plug-in current transformer; Primary rated current: 1500 A; Secondary rated current: 1 A; Rated power: 5 VA; Accuracy class: 1	www.wago.com/855-601/1500-501
	Item no.: 855-801/1000-1001 Plug-in current transformer; Primary rated current: 1000 A; Secondary rated current: 1 A; Rated power: 10 VA; Accuracy class: 1	www.wago.com/855-801/1000-1001
	Item no.: 855-801/2000-1001 Plug-in current transformer; Primary rated current: 2000 A; Secondary rated current: 1 A; Rated power: 10 VA; Accuracy class: 1	www.wago.com/855-801/2000-1001

tools

	Item no.: 210-720 Operating tool; Blade: 3.5 x 0.5 mm; with a partially insulated shaft	www.wago.com/210-720
--	---	--

transfer module

Subject to changes. Please also observe the further product documentation!



Item no.: 289-175/790-108

Interface module; RJ-45; PCB terminal blocks, double-row; Cat. 5; in mounting carrier; with shield connection; with shield clamping saddle

www.wago.com/289-175/790-108



Item no.: 289-176

Interface module; RJ-45; with power jumper contacts; RJ-45; Cat. 5; in mounting carrier

www.wago.com/289-176

Downloads

Documentation

Manual

3-Phase Power Measurement Module	V 1.0.0	pdf 16.4 MB	Download
----------------------------------	---------	----------------	----------

Bid Text

2857-570/024-001 GAEB docx - Datei	Jul 15, 2019	docx 20.1 kB	Download
---------------------------------------	--------------	-----------------	----------

2857-570/024-001 GAEB X81 - Datei	Jul 15, 2019	xml 8.8 kB	Download
--------------------------------------	--------------	---------------	----------

Instruction Leaflet

3-Phasen-Leistungsmessmodul	V 1.1.0	pdf 1.2 MB	Download
-----------------------------	---------	---------------	----------

Additional Information

Disposal; Electrical and electronic equipment, Packaging	V 1.0.0	pdf 265.8 kB	Download
--	---------	-----------------	----------

Libraries

Library

Library for the Wago 3-Phase Powertransducer module 2857-570 WAGO-I/O-PRO Library for 2857-0570/0024-000x 3-Phase Powertransducer modules	V 1.0.0 Feb 28, 2019	zip 2.2 MB	Download
--	-------------------------	---------------	----------

Engineering-Software

Software for Interface-Products

Subject to changes. Please also observe the further product documentation!

WAGO Interface Configuration Software FULL The full setup, in addition to the WAGO Interface Configuration Software, includes the installation for the Microsoft .NET Framework.	1.6.3.7 Sep 17, 2019	exe 98.5 MB	Download
WAGO Interface Configuration Software SMALL The full setup only includes the WAGO Interface Configuration Software.	1.6.3.7 Sep 17, 2019	exe 48.0 MB	Download

Handling Instructions

Configuring

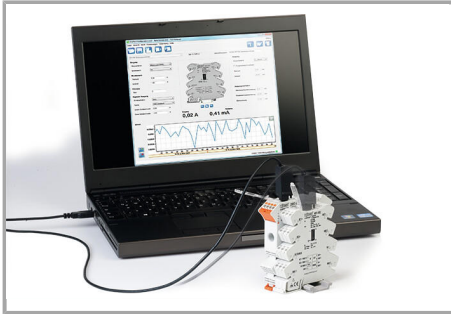

Configuration via WAGO interface configuration software

Subject to changes. Please also observe the further product documentation!