

Data sheet | Item number: 280-641

3-conductor through terminal block; 2.5 mm²; center marking; for DIN-rail 35 x 15 and 35 x 7.5; CAGE CLAMP®; 2,50 mm²; gray

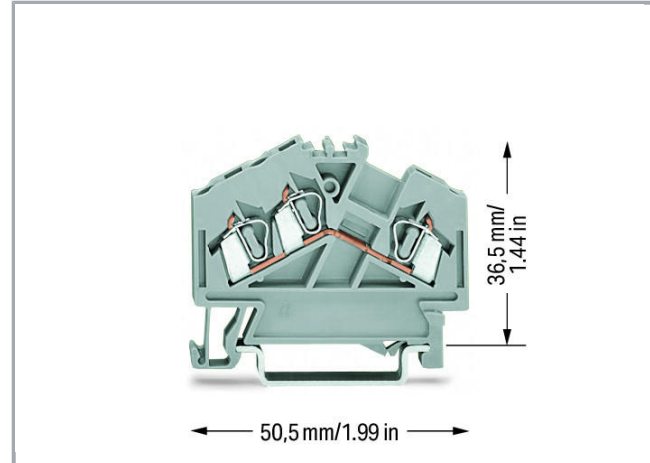

www.wago.com/280-641

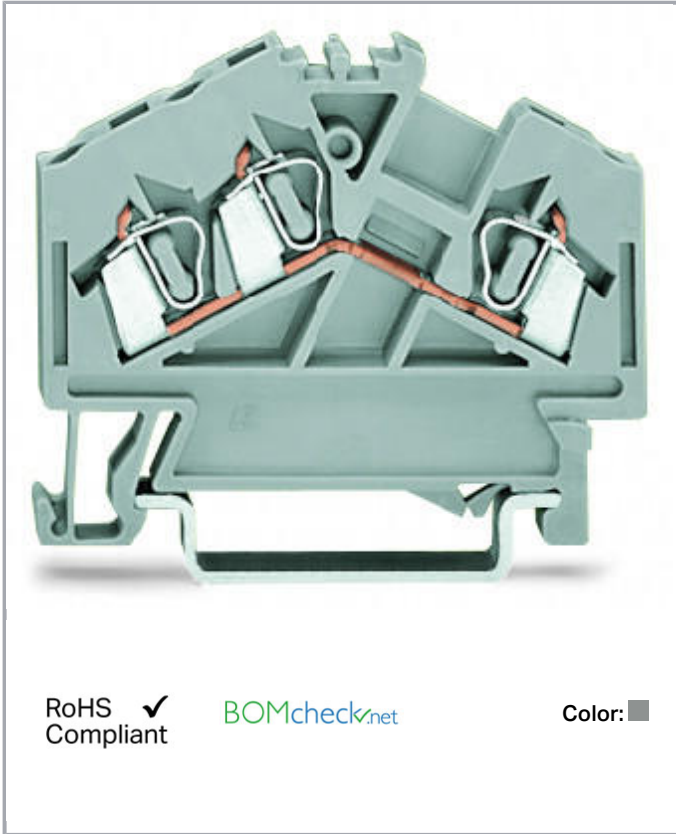

Subject to changes.

WAGO Kontakttechnik GmbH & Co. KG
Hansastr. 27
32423 Minden
Phone: +49571 887-0 | Fax: +49571 887-169
Email: info.de@wago.com | Web: www.wago.com

Do you have any questions about our products?
We are always happy to take your call at +49 (571) 887-44222.

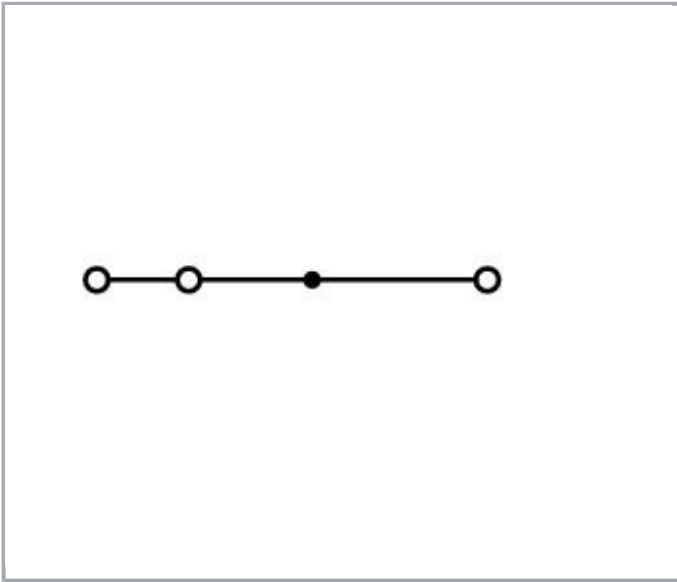

Item description

Note:

Terminating Aluminum Conductors

WAGO spring clamp terminal blocks are suitable for solid aluminum conductors up to 4 mm²/12 AWG if WAGO "Alu-Plus" Contact Paste is used for termination.

"Alu-Plus" Contact Paste Advantages:

- Automatically destroys the oxide film during clamping.
- Prevents fresh oxidation at the clamping point.
- Prevents electrolytic corrosion between aluminum and copper conductors (in the same terminal block).
- Provides long-term protection against corrosion.

Using terminal blocks with CAGE CLAMP® Spring Pressure Connection Technology, **aluminum conductors must first be cleaned with a blade** and then immediately be inserted into the clamping units filled with "Alu-Plus" Contact Paste.

It is also possible to apply WAGO "Alu-Plus" **additionally** on the whole surface of the aluminum conductor before termination.

Please note that the nominal currents must be adapted to the reduced conductivity of the aluminum conductors:

2.5 mm² (14 AWG) = 16 A

4 mm² (12 AWG) = 22 A

Data

Electrical data

Subject to changes.

Ratings per IEC/EN 60664-1

Rated voltage (III / 3)	800 V
Rated impulse voltage (III / 3)	8 kV
Rated current	24 A
Legend (ratings)	(III / 3) $\hat{=}$ Overvoltage category III / Pollution degree 3

Connection data

Connection technology	CAGE CLAMP®
Actuation type	Operating tool
Connectable conductor materials	Copper Aluminum
Solid conductor	0.08 ... 2.5 mm ² / 28 ... 12 AWG
Fine-stranded conductor	0.08 ... 2.5 mm ² / 28 ... 12 AWG
Strip length	8 ... 9 mm / 0.31 ... 0.35 inch
Total number of connection points	3
Total number of potentials	1
Number of levels	1
Type of wiring	Front-entry wiring
Note (conductor cross-section)	12 AWG: THHN, THWN

Geometrical Data

Width	5 mm / 0.197 inch
Height from upper-edge of DIN-35 rail	36.5 mm / 1.437 inch
Depth	50.5 mm / 1.988 inch

Mechanical data

Design	angled
Type of mounting	DIN-35 rail
Marking level	Center marking

Material Data

Color	gray
Insulating material	Polyamide 66 (PA 66)
Fire load	0.121 MJ
Weight	6.7 g



Subject to changes.

Commercial data





Product Group	1 (Rail Mounted Terminal Blocks)
Packaging type	BOX
Country of origin	DE
GTIN	4044918325806
Customs Tariff No.	85369010000

Approvals / Certificates

Country specific Approvals

Logo	Approval	Additional Approval Text	Certificate name
	CCA DEKRA Certification B.V.	EN 60947	2157201.01
	CSA DEKRA Certification B.V.	C22.2	1536071

Ship Approvals

Logo	Approval	Additional Approval Text	Certificate name
	ABS American Bureau of Shipping	EN 60947	14- HG1293677- PDA
	BV Bureau Veritas S.A.	EN 60947	07436/E0 BV
	DNV GL Det Norske Veritas, Germanischer Lloyd	-	TAE00001V2
	LR Lloyds Register	EN 60947	91/20112 (E9)

UL-Approvals









Certificate

Subject to changes.

Logo	Approval	Additional Approval Text	name
	UL UL International Germany GmbH	UL 1059	20190731- E45172















Compatible products

ferrule















	Item no.: 216-101 Ferrule; Sleeve for 0.5 mm ² / AWG 22; uninsulated; electro-tin plated	www.wago.com/216-101
	Item no.: 216-102 Ferrule; Sleeve for 0.75 mm ² / AWG 20; uninsulated; electro-tin plated	www.wago.com/216-102
	Item no.: 216-103 Ferrule; Sleeve for 1 mm ² / AWG 18; uninsulated; electro-tin plated	www.wago.com/216-103
	Item no.: 216-104 Ferrule; Sleeve for 1.5 mm ² / AWG 16; uninsulated; electro-tin plated	www.wago.com/216-104
	Item no.: 216-201 Ferrule; Sleeve for 0.5 mm ² / 20 AWG; insulated; electro-tin plated; white	www.wago.com/216-201
	Item no.: 216-202 Ferrule; Sleeve for 0.75 mm ² / 18 AWG; insulated; electro-tin plated; gray	www.wago.com/216-202
	Item no.: 216-203 Ferrule; Sleeve for 1 mm ² / AWG 18; insulated; electro-tin plated; red	www.wago.com/216-203
	Item no.: 216-204 Ferrule; Sleeve for 1.5 mm ² / AWG 16; insulated; electro-tin plated; black	www.wago.com/216-204
	Item no.: 216-301 Ferrule; Sleeve for 0.25 mm ² / AWG 24; insulated; electro-tin plated; yellow	www.wago.com/216-301
	Item no.: 216-302 Ferrule; Sleeve for 0.34 mm ² / 22 AWG; insulated; electro-tin plated; green	www.wago.com/216-302

Subject to changes.

Marking accessories

	Item no.: 2009-115 WMB-Inline; for Smart Printer; on reel; stretchable 5 - 5.2 mm; plain; snap-on type; white	www.wago.com/2009-115
	Item no.: 2009-115/000-002 WMB-Inline; for Smart Printer; on reel; stretchable 5 - 5.2 mm; plain; snap-on type; yellow	www.wago.com/2009-115/000-002
	Item no.: 2009-115/000-006 WMB-Inline; for Smart Printer; on reel; stretchable 5 - 5.2 mm; plain; snap-on type; blue	www.wago.com/2009-115/000-006
	Item no.: 2009-115/000-007 WMB-Inline; for Smart Printer; on reel; stretchable 5 - 5.2 mm; plain; snap-on type; gray	www.wago.com/2009-115/000-007
	Item no.: 2009-115/000-012 WMB-Inline; for Smart Printer; on reel; stretchable 5 - 5.2 mm; plain; snap-on type; orange	www.wago.com/2009-115/000-012
	Item no.: 2009-115/000-017 WMB-Inline; for Smart Printer; on reel; stretchable 5 - 5.2 mm; plain; snap-on type; light green	www.wago.com/2009-115/000-017
	Item no.: 2009-115/000-023 WMB-Inline; for Smart Printer; on reel; stretchable 5 - 5.2 mm; plain; snap-on type; green	www.wago.com/2009-115/000-023
	Item no.: 2009-115/000-024 WMB-Inline; for Smart Printer; on reel; stretchable 5 - 5.2 mm; plain; snap-on type; violet	www.wago.com/2009-115/000-024
	Item no.: 209-128 Adaptor	www.wago.com/209-128
	Item no.: 209-140 Group marker carrier	www.wago.com/209-140
	Item no.: 209-141 Group marker carrier	www.wago.com/209-141
	Item no.: 209-142 Group marker carrier	www.wago.com/209-142
	Item no.: 209-185 Adaptor	www.wago.com/209-185
	Item no.: 210-612 Marking strips; for self-marking; plain; Self-adhesive; transparent	www.wago.com/210-612
	Item no.: 249-105 Group marker carrier	www.wago.com/249-105

Subject to changes.

	<p>Item no.: 793-501 WMB marking card; as card; not stretchable; plain; snap-on type; white</p>	www.wago.com/793-501
	<p>Item no.: 793-501/000-002 WMB marking card; as card; not stretchable; plain; snap-on type; yellow</p>	www.wago.com/793-501/000-002
	<p>Item no.: 793-501/000-005 WMB marking card; as card; not stretchable; plain; snap-on type; red</p>	www.wago.com/793-501/000-005
	<p>Item no.: 793-501/000-006 WMB marking card; as card; not stretchable; plain; snap-on type; blue</p>	www.wago.com/793-501/000-006
	<p>Item no.: 793-501/000-007 WMB marking card; as card; not stretchable; plain; snap-on type; gray</p>	www.wago.com/793-501/000-007
	<p>Item no.: 793-501/000-012 WMB marking card; as card; not stretchable; plain; snap-on type; orange</p>	www.wago.com/793-501/000-012
	<p>Item no.: 793-501/000-017 WMB marking card; as card; not stretchable; plain; snap-on type; light green</p>	www.wago.com/793-501/000-017
	<p>Item no.: 793-501/000-023 WMB marking card; as card; not stretchable; plain; snap-on type; green</p>	www.wago.com/793-501/000-023
	<p>Item no.: 793-501/000-024 WMB marking card; as card; not stretchable; plain; snap-on type; violet</p>	www.wago.com/793-501/000-024
	<p>Item no.: 793-5501 WMB marking card; as card; for terminal block width 5 - 17.5 mm; stretchable 5 - 5.2 mm; plain; snap-on type; white</p>	www.wago.com/793-5501
	<p>Item no.: 793-5501/000-002 WMB marking card; as card; for terminal block width 5 - 17.5 mm; stretchable 5 - 5.2 mm; plain; snap-on type; yellow</p>	www.wago.com/793-5501/000-002
	<p>Item no.: 793-5501/000-005 WMB marking card; as card; stretchable 5 - 5.2 mm; plain; snap-on type; red</p>	www.wago.com/793-5501/000-005
	<p>Item no.: 793-5501/000-006 WMB marking card; as card; stretchable 5 - 5.2 mm; plain; snap-on type; blue</p>	www.wago.com/793-5501/000-006
	<p>Item no.: 793-5501/000-007 WMB marking card; as card; stretchable 5 - 5.2 mm; plain; snap-on type; gray</p>	www.wago.com/793-5501/000-007

Subject to changes.



Item no.: 793-5501/000-012
WMB marking card; as card; stretchable 5 - 5.2 mm; plain; snap-on type; orange

www.wago.com/793-5501/000-012



Item no.: 793-5501/000-017
WMB marking card; as card; stretchable 5 - 5.2 mm; plain; snap-on type; light green

www.wago.com/793-5501/000-017



Item no.: 793-5501/000-023
WMB marking card; as card; stretchable 5 - 5.2 mm; plain; snap-on type; green

www.wago.com/793-5501/000-023



Item no.: 793-5501/000-024
WMB marking card; as card; stretchable 5 - 5.2 mm; plain; snap-on type; violet

www.wago.com/793-5501/000-024

check



Item no.: 209-170
Test plug adapter; 8.3 mm wide; for 4 mm Ø test plugs; suitable for 1.5 mm² - 10 mm² tbs; gray

www.wago.com/209-170



Item no.: 249-106
B-type test plug module; modular; 1,50 mm²; gray

www.wago.com/249-106



Item no.: 249-107
B-type spacer module; modular; e.g., for bridging commoned terminal blocks; gray

www.wago.com/249-107



Item no.: 249-141
L-type test plug module; modular; with spring-loaded contact pin; Center module; 1,50 mm²; gray

www.wago.com/249-141



Item no.: 280-404
Test plug adapter; 5 mm wide; for test plug 210-137 (2.3 mm Ø); suitable for 1.5 mm² - 4 mm² tbs; gray

www.wago.com/280-404



Item no.: 280-418
Test plug module; modular; suitable for all WAGO 280 and 780 Series rail-mounted terminal blocks with jumper slots in the current bar; gray

www.wago.com/280-418



Item no.: 280-419
Spacer module; modular; bridging commoned terminal blocks; gray

www.wago.com/280-419

Insulation stop



Item no.: 280-470
Insulation stop; 0.08 - 0.2 mm² "s" (0.14 mm² "f-st"); 5 pieces/strip; white

www.wago.com/280-470



Item no.: 280-471
Insulation stop; 0.25 - 0.5 mm²; 5 pieces/strip; light gray

www.wago.com/280-471



Item no.: 280-472
Insulation stop; 0.75 - 1 mm²; 5 pieces/strip

www.wago.com/280-472

assembling



Item no.: 209-106
Mounting carrier; for isolated mounting on DIN 35 rails; gray

www.wago.com/209-106

Subject to changes.



Item no.: 709-153
Cover; Type 1; suitable for cover carrier, type 1; 1 m long; transparent

www.wago.com/709-153

tools



Item no.: 210-657
Operating tool; Blade: 3.5 x 0.5 mm; with a partially insulated shaft; short

www.wago.com/210-657



Item no.: 210-658
Operating tool; Blade: 3.5 x 0.5 mm; with a partially insulated shaft; angled; short

www.wago.com/210-658



Item no.: 210-720
Operating tool; Blade: 3.5 x 0.5 mm; with a partially insulated shaft

www.wago.com/210-720

Protective Warning Marker



Item no.: 280-415
Protective warning marker; with high-voltage symbol, black; for 5 terminal blocks; yellow

www.wago.com/280-415

General accessories



Item no.: 231-162/003-000
Male connector for rail-mount terminal blocks; 1.2 x 1.2 mm pins; straight; Pin spacing 5 mm; 2-pole; gray

www.wago.com/231-162/003-000



Item no.: 231-163/003-000
Male connector for rail-mount terminal blocks; 1.2 x 1.2 mm pins; straight; Pin spacing 5 mm; 3-pole; gray

www.wago.com/231-163/003-000



Item no.: 231-164/003-000
Male connector for rail-mount terminal blocks; 1.2 x 1.2 mm pins; straight; Pin spacing 5 mm; 4-pole; gray

www.wago.com/231-164/003-000



Item no.: 231-165/003-000
Male connector for rail-mount terminal blocks; 1.2 x 1.2 mm pins; straight; Pin spacing 5 mm; 5-pole; gray

www.wago.com/231-165/003-000



Item no.: 231-166/003-000
Male connector for rail-mount terminal blocks; 1.2 x 1.2 mm pins; straight; Pin spacing 5 mm; 6-pole; gray

www.wago.com/231-166/003-000



Item no.: 231-167/003-000
Male connector for rail-mount terminal blocks; 1.2 x 1.2 mm pins; straight; Pin spacing 5 mm; 7-pole; gray

www.wago.com/231-167/003-000



Item no.: 231-168/003-000
Male connector for rail-mount terminal blocks; 1.2 x 1.2 mm pins; straight; Pin spacing 5 mm; 8-pole; gray

www.wago.com/231-168/003-000



Item no.: 231-169/003-000
Male connector for rail-mount terminal blocks; 1.2 x 1.2 mm pins; straight; Pin spacing 5 mm; 9-pole; gray















www.wago.com/231-169/003-000

















Item no.: 231-170/003-000
Male connector for rail-mount terminal blocks; 1.2 x 1.2 mm pins; straight; Pin spacing 5 mm; 10-pole; gray

www.wago.com/231-170/003-000















Subject to changes.

	Item no.: 231-171/003-000 Male connector for rail-mount terminal blocks; 1.2 x 1.2 mm pins; straight; Pin spacing 5 mm; 11-pole; gray	www.wago.com/231-171/003-000
	Item no.: 231-172/003-000 Male connector for rail-mount terminal blocks; 1.2 x 1.2 mm pins; straight; Pin spacing 5 mm; 12-pole; gray	www.wago.com/231-172/003-000
	Item no.: 231-176/003-000 Male connector for rail-mount terminal blocks; 1.2 x 1.2 mm pins; straight; Pin spacing 5 mm; 16-pole; gray	www.wago.com/231-176/003-000
	Item no.: 231-180/003-000 Male connector for rail-mount terminal blocks; 1.2 x 1.2 mm pins; straight; Pin spacing 5 mm; 20-pole; gray	www.wago.com/231-180/003-000
	Item no.: 231-668 Lockout caps; for covering unused clamping units; gray	www.wago.com/231-668
	Item no.: 231-669 Lockout caps; for covering unused clamping units; orange	www.wago.com/231-669
	Item no.: 281-407 Test plug; 6 mm wide; Nominal current 24 A; for 0.08 mm ² - 2.5 mm ² ; 2,50 mm ² ; gray	www.wago.com/281-407
	Item no.: 721-162/003-000 Male connector for rail-mount terminal blocks; 1.2 x 1.2 mm pins; straight; 100% protected against mismatching; Pin spacing 5 mm; 2-pole; light gray	www.wago.com/721-162/003-000
	Item no.: 721-163/003-000 Male connector for rail-mount terminal blocks; 1.2 x 1.2 mm pins; straight; 100% protected against mismatching; Pin spacing 5 mm; 3-pole; light gray	www.wago.com/721-163/003-000
	Item no.: 721-164/003-000 Male connector for rail-mount terminal blocks; 1.2 x 1.2 mm pins; straight; 100% protected against mismatching; Pin spacing 5 mm; 4-pole; light gray	www.wago.com/721-164/003-000
	Item no.: 721-165/003-000 Male connector for rail-mount terminal blocks; 1.2 x 1.2 mm pins; straight; 100% protected against mismatching; Pin spacing 5 mm; 5-pole; light gray	www.wago.com/721-165/003-000
	Item no.: 721-166/003-000 Male connector for rail-mount terminal blocks; 1.2 x 1.2 mm pins; straight; 100% protected against mismatching; Pin spacing 5 mm; 6-pole; light gray	www.wago.com/721-166/003-000
	Item no.: 721-167/003-000 Male connector for rail-mount terminal blocks; 1.2 x 1.2 mm pins; straight; 100% protected against mismatching; Pin spacing 5 mm; 7-pole; light gray	www.wago.com/721-167/003-000
	Item no.: 721-168/003-000 Male connector for rail-mount terminal blocks; 1.2 x 1.2 mm pins; straight; 100% protected against mismatching; Pin spacing 5 mm; 8-pole; light gray	www.wago.com/721-168/003-000



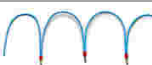

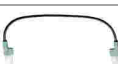













Subject to changes.

	Item no.: 721-169/003-000 Male connector for rail-mount terminal blocks; 1.2 x 1.2 mm pins; straight; 100% protected against mismatching; Pin spacing 5 mm; 9-pole; light gray	www.wago.com/721-169/003-000
	Item no.: 721-170/003-000 Male connector for rail-mount terminal blocks; 1.2 x 1.2 mm pins; straight; 100% protected against mismatching; Pin spacing 5 mm; 10-pole; light gray	www.wago.com/721-170/003-000
	Item no.: 721-171/003-000 Male connector for rail-mount terminal blocks; 1.2 x 1.2 mm pins; straight; 100% protected against mismatching; Pin spacing 5 mm; 11-pole; light gray	www.wago.com/721-171/003-000
	Item no.: 721-172/003-000 Male connector for rail-mount terminal blocks; 1.2 x 1.2 mm pins; straight; 100% protected against mismatching; Pin spacing 5 mm; 12-pole; light gray	www.wago.com/721-172/003-000
	Item no.: 721-173/003-000 Male connector for rail-mount terminal blocks; 1.2 x 1.2 mm pins; straight; 100% protected against mismatching; Pin spacing 5 mm; 13-pole; light gray	www.wago.com/721-173/003-000
	Item no.: 721-174/003-000 Male connector for rail-mount terminal blocks; 1.2 x 1.2 mm pins; straight; 100% protected against mismatching; Pin spacing 5 mm; 14-pole; light gray	www.wago.com/721-174/003-000
	Item no.: 721-175/003-000 Male connector for rail-mount terminal blocks; 1.2 x 1.2 mm pins; straight; 100% protected against mismatching; Pin spacing 5 mm; 15-pole; light gray	www.wago.com/721-175/003-000
	Item no.: 721-176/003-000 Male connector for rail-mount terminal blocks; 1.2 x 1.2 mm pins; straight; 100% protected against mismatching; Pin spacing 5 mm; 16-pole; light gray	www.wago.com/721-176/003-000
	Item no.: 721-180/003-000 Male connector for rail-mount terminal blocks; 1.2 x 1.2 mm pins; straight; 100% protected against mismatching; Pin spacing 5 mm; 20-pole; light gray	www.wago.com/721-180/003-000
Carrier rail		
	Item no.: 210-112 Steel carrier rail; 35 x 7.5 mm; 1 mm thick; 2 m long; slotted; according to EN 60715; "Hole width 25 mm	www.wago.com/210-112
	Item no.: 210-113 Steel carrier rail; 35 x 7.5 mm; 1 mm thick; 2 m long; unslotted; according to EN 60715	www.wago.com/210-113
	Item no.: 210-114 Steel carrier rail; 35 x 15 mm; 1.5 mm thick; 2 m long; unslotted; similar to EN 60715	www.wago.com/210-114
	Item no.: 210-115 Steel carrier rail; 35 x 7.5 mm; 1 mm thick; 2 m long; slotted; according to EN 60715; "Hole width 18 mm	www.wago.com/210-115
	Item no.: 210-118 Steel carrier rail; 35 x 15 mm; 2.3 mm thick; 2 m long; unslotted; according to EN 60715	www.wago.com/210-118
	Item no.: 210-196	

Subject to changes.

	Aluminum carrier rail; 35 x 8.2 mm; 1.6 mm thick; 2 m long; unslotted; similar to EN 60715; silver-colored	www.wago.com/210-196
	Item no.: 210-197 Steel carrier rail; 35 x 15 mm; 1.5 mm thick; 2 m long; slotted; similar to EN 60715	www.wago.com/210-197
	Item no.: 210-198 Copper carrier rail; 35 x 15 mm; 2.3 mm thick; 2 m long; unslotted; according to EN 60715; copper-colored	www.wago.com/210-198
	Item no.: 210-504 Steel carrier rail; 35 x 7.5 mm; 1 mm thick; 2 m long; slotted; galvanized; according to EN 60715	www.wago.com/210-504
	Item no.: 210-505 Steel carrier rail; 35 x 7.5 mm; 1 mm thick; 2 m long; unslotted; galvanized; according to EN 60715	www.wago.com/210-505
	Item no.: 210-506 Steel carrier rail; 35 x 15 mm; 1.5 mm thick; 2 m long; unslotted; galvanized; similar to EN 60715	www.wago.com/210-506
	Item no.: 210-508 Steel carrier rail; 35 x 15 mm; 1.5 mm thick; 2 m long; slotted; galvanized; similar to EN 60715	www.wago.com/210-508
End plate		
	Item no.: 280-312 End and intermediate plate; 2.5 mm thick; gray	www.wago.com/280-312
	Item no.: 280-313 End and intermediate plate; 2.5 mm thick; orange	www.wago.com/280-313
	Item no.: 280-318 Separator plate; 2.5 mm thick; oversized; orange	www.wago.com/280-318
	Item no.: 280-348 Separator plate; 2.5 mm thick; oversized; gray	www.wago.com/280-348
Jumper		
	Item no.: 210-103 Wire commoning chain; insulated; 50 connections; black	www.wago.com/210-103
	Item no.: 210-123 Wire commoning chain; insulated; 50 connections	www.wago.com/210-123
	Item no.: 249-123 Push-in type wire jumper; insulated; wire length 180 mm; Conductor cross section 0.75 mm ²	www.wago.com/249-123
	Item no.: 249-125 Push-in type wire jumper; insulated; wire length 60 mm; Conductor cross section 0.75 mm ²	www.wago.com/249-125
	Item no.: 249-126 Push-in type wire jumper; insulated; wire length 110 mm; Conductor cross section 0.75 mm ²	www.wago.com/249-126
	Item no.: 249-127 Push-in type wire jumper; insulated; wire length 250 mm; Conductor cross section 0.75 mm ²	www.wago.com/249-127

Subject to changes.

	Item no.: 280-402 Adjacent jumper; insulated; IN = IN terminal block; gray	www.wago.com/280-402
	Item no.: 280-409 Alternate jumper; insulated; IN = IN terminal block; gray	www.wago.com/280-409
	Item no.: 280-422 Adjacent jumper; insulated; IN = IN terminal block; yellow-green	www.wago.com/280-422
	Item no.: 280-482 Comb-style jumper bar; insulated; 2-way; IN = IN terminal block; gray	www.wago.com/280-482
	Item no.: 280-483 Comb-style jumper bar; insulated; 3-way; IN = IN terminal block; gray	www.wago.com/280-483
	Item no.: 280-484 Comb-style jumper bar; insulated; 4-way; IN = IN terminal block; gray	www.wago.com/280-484
	Item no.: 280-485 Comb-style jumper bar; insulated; 5-way; IN = IN terminal block; gray	www.wago.com/280-485
	Item no.: 280-490 Comb-style jumper bar; insulated; 10-way; IN = IN terminal block; gray	www.wago.com/280-490
	Item no.: 280-492 Alternate comb-style jumper bar; insulated; 2-way; IN = IN terminal block; gray	www.wago.com/280-492
	Item no.: 709-110 Wire commoning chain; insulated; 4 connections; 3 x 110 mm; black	www.wago.com/709-110
	Item no.: 709-111 Wire commoning chain; insulated; 3 connections; 2 x 120 mm; black	www.wago.com/709-111
	Item no.: 709-112 Wire commoning chain; insulated; 3 connections; 2 x 170 mm; black	www.wago.com/709-112
	Item no.: 780-452 Staggered jumper; insulated; from 1 to 2; Spacing: 5 mm; suitable for 2-conductor female plugs; gray	www.wago.com/780-452
	Item no.: 780-453 Staggered jumper; insulated; from 1 to 3; Spacing: 5 mm; suitable for 2-conductor female plugs; gray	www.wago.com/780-453
	Item no.: 780-454 Staggered jumper; insulated; from 1 to 4; Spacing: 5 mm; suitable for 2-conductor female plugs; gray	www.wago.com/780-454
	Item no.: 780-455 Staggered jumper; insulated; from 1 to 5; Spacing: 5 mm; suitable for 2-conductor female plugs; gray	www.wago.com/780-455
	Item no.: 780-456 Staggered jumper; insulated; from 1 to 6; Spacing: 5 mm; suitable for 2-conductor female plugs; gray	www.wago.com/780-456
	Item no.: 780-457 Staggered jumper; insulated; from 1 to 7; Spacing: 5 mm; suitable for 2-conductor female plugs; gray	www.wago.com/780-457

Subject to changes.



Item no.: 780-458

www.wago.com/780-458

Staggered jumper; insulated; from 1 to 8; Spacing: 5 mm; suitable for 2-conductor female plugs; gray

Female plug



Item no.: 232-132/005-000

www.wago.com/232-132/005-000

Female connector for rail-mount terminal blocks; 0.6 x 1 mm pins; straight; Pin spacing 5 mm; 2-pole; gray



Item no.: 232-132/005-000/039-000

www.wago.com/232-132/005-000/039-000

Female connector for rail-mount terminal blocks; 0.6 x 1 mm pins; straight; Locking lever; Pin spacing 5 mm; 2-pole; gray



Item no.: 232-133/005-000

www.wago.com/232-133/005-000

Female connector for rail-mount terminal blocks; 0.6 x 1 mm pins; straight; Pin spacing 5 mm; 3-pole; gray



Item no.: 232-133/005-000/039-000

www.wago.com/232-133/005-000/039-000

Female connector for rail-mount terminal blocks; 0.6 x 1 mm pins; straight; Locking lever; Pin spacing 5 mm; 3-pole; gray



Item no.: 232-134/005-000

www.wago.com/232-134/005-000

Female connector for rail-mount terminal blocks; 0.6 x 1 mm pins; straight; Pin spacing 5 mm; 4-pole; gray



Item no.: 232-134/005-000/039-000

www.wago.com/232-134/005-000/039-000

Female connector for rail-mount terminal blocks; 0.6 x 1 mm pins; straight; Locking lever; Pin spacing 5 mm; 4-pole; gray



Item no.: 232-135/005-000

www.wago.com/232-135/005-000

Female connector for rail-mount terminal blocks; 0.6 x 1 mm pins; straight; Pin spacing 5 mm; 5-pole; gray



Item no.: 232-135/005-000/039-000

www.wago.com/232-135/005-000/039-000

Female connector for rail-mount terminal blocks; 0.6 x 1 mm pins; straight; Locking lever; Pin spacing 5 mm; 5-pole; gray



Item no.: 232-136/005-000

www.wago.com/232-136/005-000

Female connector for rail-mount terminal blocks; 0.6 x 1 mm pins; straight; Pin spacing 5 mm; 6-pole; gray



Item no.: 232-136/005-000/039-000

www.wago.com/232-136/005-000/039-000

Female connector for rail-mount terminal blocks; 0.6 x 1 mm pins; straight; Locking lever; Pin spacing 5 mm; 6-pole; gray



Item no.: 232-137/005-000

www.wago.com/232-137/005-000

Female connector for rail-mount terminal blocks; 0.6 x 1 mm pins; straight; Pin spacing 5 mm; 7-pole; gray



Item no.: 232-137/005-000/039-000

www.wago.com/232-137/005-000/039-000

Female connector for rail-mount terminal blocks; 0.6 x 1 mm pins; straight; Locking lever; Pin spacing 5 mm; 7-pole; gray

Item no.: 232-138/005-000

Subject to changes.

WAGO Kontakttechnik GmbH & Co. KG

Hansastr. 27













32423 Minden

Phone: +49571 887-0 | Fax: +49571 887-169













Email: info.de@wago.com | Web: www.wago.com

Do you have any questions about our products?

We are always happy to take your call at +49 (571) 887-44222.













	Female connector for rail-mount terminal blocks; 0.6 x 1 mm pins; straight; Pin spacing 5 mm; 8-pole; gray	www.wago.com/232-138/005-000
	Item no.: 232-138/005-000/039-000 Female connector for rail-mount terminal blocks; 0.6 x 1 mm pins; straight; Locking lever; Pin spacing 5 mm; 8-pole; gray	www.wago.com/232-138/005-000/039-000
	Item no.: 232-139/005-000 Female connector for rail-mount terminal blocks; 0.6 x 1 mm pins; straight; Pin spacing 5 mm; 9-pole; gray	www.wago.com/232-139/005-000
	Item no.: 232-139/005-000/039-000 Female connector for rail-mount terminal blocks; 0.6 x 1 mm pins; straight; Locking lever; Pin spacing 5 mm; 9-pole; gray	www.wago.com/232-139/005-000/039-000
	Item no.: 232-140/005-000 Female connector for rail-mount terminal blocks; 0.6 x 1 mm pins; straight; Pin spacing 5 mm; 10-pole; gray	www.wago.com/232-140/005-000
	Item no.: 232-140/005-000/039-000 Female connector for rail-mount terminal blocks; 0.6 x 1 mm pins; straight; Locking lever; Pin spacing 5 mm; 10-pole; gray	www.wago.com/232-140/005-000/039-000
	Item no.: 232-142/005-000 Female connector for rail-mount terminal blocks; 0.6 x 1 mm pins; straight; Pin spacing 5 mm; 12-pole; gray	www.wago.com/232-142/005-000
	Item no.: 232-142/005-000/039-000 Female connector for rail-mount terminal blocks; 0.6 x 1 mm pins; straight; Locking lever; Pin spacing 5 mm; 12-pole; gray	www.wago.com/232-142/005-000/039-000
	Item no.: 232-146/005-000 Female connector for rail-mount terminal blocks; 0.6 x 1 mm pins; straight; Pin spacing 5 mm; 16-pole; gray	www.wago.com/232-146/005-000
	Item no.: 232-146/005-000/039-000 Female connector for rail-mount terminal blocks; 0.6 x 1 mm pins; straight; Locking lever; Pin spacing 5 mm; 16-pole; gray	www.wago.com/232-146/005-000/039-000
	Item no.: 232-147/005-000/039-000 Female connector for rail-mount terminal blocks; 0.6 x 1 mm pins; straight; Locking lever; Pin spacing 5 mm; 17-pole; gray	www.wago.com/232-147/005-000/039-000
	Item no.: 232-150/005-000 Female connector for rail-mount terminal blocks; 0.6 x 1 mm pins; straight; Pin spacing 5 mm; 20-pole; gray	www.wago.com/232-150/005-000
	Item no.: 232-150/005-000/039-000 Female connector for rail-mount terminal blocks; 0.6 x 1 mm pins; straight; Locking lever; Pin spacing 5 mm; 20-pole; gray	www.wago.com/232-150/005-000/039-000
	Item no.: 232-232/005-000	

Subject to changes.

	Female connector for rail-mount terminal blocks; 0.6 x 1 mm pins; angled; Pin spacing 5 mm; 2-pole; gray	www.wago.com/232-232/005-000
	Item no.: 232-232/005-000/039-000 Female connector for rail-mount terminal blocks; 0.6 x 1 mm pins; angled; Locking lever; Pin spacing 5 mm; 2-pole; gray	www.wago.com/232-232/005-000/039-000
	Item no.: 232-233/005-000 Female connector for rail-mount terminal blocks; 0.6 x 1 mm pins; angled; Pin spacing 5 mm; 3-pole; gray	www.wago.com/232-233/005-000
	Item no.: 232-233/005-000/039-000 Female connector for rail-mount terminal blocks; 0.6 x 1 mm pins; angled; Locking lever; Pin spacing 5 mm; 3-pole; gray	www.wago.com/232-233/005-000/039-000
	Item no.: 232-234/005-000 Female connector for rail-mount terminal blocks; 0.6 x 1 mm pins; angled; Pin spacing 5 mm; 4-pole; gray	www.wago.com/232-234/005-000
	Item no.: 232-234/005-000/039-000 Female connector for rail-mount terminal blocks; 0.6 x 1 mm pins; angled; Locking lever; Pin spacing 5 mm; 4-pole; gray	www.wago.com/232-234/005-000/039-000
	Item no.: 232-235/005-000 Female connector for rail-mount terminal blocks; 0.6 x 1 mm pins; angled; Pin spacing 5 mm; 5-pole; gray	www.wago.com/232-235/005-000
	Item no.: 232-235/005-000/039-000 Female connector for rail-mount terminal blocks; 0.6 x 1 mm pins; angled; Locking lever; Pin spacing 5 mm; 5-pole; gray	www.wago.com/232-235/005-000/039-000
	Item no.: 232-236/005-000 Female connector for rail-mount terminal blocks; 0.6 x 1 mm pins; angled; Pin spacing 5 mm; 6-pole; gray	www.wago.com/232-236/005-000
	Item no.: 232-236/005-000/039-000 Female connector for rail-mount terminal blocks; 0.6 x 1 mm pins; angled; Locking lever; Pin spacing 5 mm; 6-pole; gray	www.wago.com/232-236/005-000/039-000
	Item no.: 232-237/005-000 Female connector for rail-mount terminal blocks; 0.6 x 1 mm pins; angled; Pin spacing 5 mm; 7-pole; gray	www.wago.com/232-237/005-000
	Item no.: 232-238/005-000 Female connector for rail-mount terminal blocks; 0.6 x 1 mm pins; angled; Pin spacing 5 mm; 8-pole; gray	www.wago.com/232-238/005-000
	Item no.: 232-239/005-000 Female connector for rail-mount terminal blocks; 0.6 x 1 mm pins; angled; Pin spacing 5 mm; 9-pole; gray	www.wago.com/232-239/005-000

Item no.: 232-240/005-000

Subject to changes.

	Female connector for rail-mount terminal blocks; 0.6 x 1 mm pins; angled; Pin spacing 5 mm; 10-pole; gray	www.wago.com/232-240/005-000
	Item no.: 232-240/005-000/039-000 Female connector for rail-mount terminal blocks; 0.6 x 1 mm pins; angled; Locking lever; Pin spacing 5 mm; 10-pole; gray	www.wago.com/232-240/005-000/039-000
	Item no.: 232-242/005-000 Female connector for rail-mount terminal blocks; 0.6 x 1 mm pins; angled; Pin spacing 5 mm; 12-pole; gray	www.wago.com/232-242/005-000
	Item no.: 232-242/005-000/039-000 Female connector for rail-mount terminal blocks; 0.6 x 1 mm pins; angled; Locking lever; Pin spacing 5 mm; 12-pole; gray	www.wago.com/232-242/005-000/039-000
	Item no.: 232-246/005-000 Female connector for rail-mount terminal blocks; 0.6 x 1 mm pins; angled; Pin spacing 5 mm; 16-pole; gray	www.wago.com/232-246/005-000
	Item no.: 232-246/005-000/039-000 Female connector for rail-mount terminal blocks; 0.6 x 1 mm pins; angled; Locking lever; Pin spacing 5 mm; 16-pole; gray	www.wago.com/232-246/005-000/039-000
	Item no.: 232-250/005-000 Female connector for rail-mount terminal blocks; 0.6 x 1 mm pins; angled; Pin spacing 5 mm; 20-pole; gray	www.wago.com/232-250/005-000
	Item no.: 232-250/005-000/039-000 Female connector for rail-mount terminal blocks; 0.6 x 1 mm pins; angled; Locking lever; Pin spacing 5 mm; 20-pole; gray	www.wago.com/232-250/005-000/039-000
	Item no.: 232-732/005-000 Female connector for rail-mount terminal blocks; 0.6 x 1 mm pins; straight; Pin spacing 7.5 mm; 2-pole; gray	www.wago.com/232-732/005-000
	Item no.: 232-733/005-000 Female connector for rail-mount terminal blocks; 0.6 x 1 mm pins; straight; Pin spacing 7.5 mm; 3-pole; gray	www.wago.com/232-733/005-000
	Item no.: 232-734/005-000 THT female header; 0.6 x 1.0 mm solder pin; gray	www.wago.com/232-734/005-000
	Item no.: 232-734/005-000/039-000 Female connector for rail-mount terminal blocks; 0.6 x 1 mm pins; straight; Locking lever; Pin spacing 7.5 mm; 4-pole; gray	www.wago.com/232-734/005-000/039-000
	Item no.: 232-735/005-000 Female connector for rail-mount terminal blocks; 0.6 x 1 mm pins; straight; Pin spacing 7.5 mm; 5-pole; gray	www.wago.com/232-735/005-000
	Item no.: 232-735/005-000/039-000	

Subject to changes.



Female connector for rail-mount terminal blocks; 0.6 x 1 mm pins; straight; Locking lever; Pin spacing 7.5 mm; 5-pole; gray www.wago.com/232-735/005-000/039-000



Item no.: 232-736/005-000
Female connector for rail-mount terminal blocks; 0.6 x 1 mm pins; straight; Pin spacing 7.5 mm; 6-pole; gray www.wago.com/232-736/005-000



Item no.: 232-736/005-000/039-000
Female connector for rail-mount terminal blocks; 0.6 x 1 mm pins; straight; Locking lever; Pin spacing 7.5 mm; 6-pole; gray www.wago.com/232-736/005-000/039-000



Item no.: 232-738/005-000
Female connector for rail-mount terminal blocks; 0.6 x 1 mm pins; straight; Pin spacing 7.5 mm; 8-pole; gray www.wago.com/232-738/005-000



Item no.: 232-740/005-000
THT female header; 0.6 x 1.0 mm solder pin; gray www.wago.com/232-740/005-000



Item no.: 232-742/005-000
Female connector for rail-mount terminal blocks; 0.6 x 1 mm pins; straight; Pin spacing 7.5 mm; 12-pole; gray www.wago.com/232-742/005-000



Item no.: 232-832/005-000
THT female header; 0.6 x 1.0 mm solder pin; angled; Pin spacing 7.5 mm; 2-pole; gray www.wago.com/232-832/005-000



Item no.: 232-833/005-000
THT female header; 0.6 x 1.0 mm solder pin; angled; Pin spacing 7.5 mm; 3-pole; gray www.wago.com/232-833/005-000



Item no.: 232-834/005-000
THT female header; 0.6 x 1.0 mm solder pin; angled; Pin spacing 7.5 mm; 4-pole; gray www.wago.com/232-834/005-000



Item no.: 232-836/005-000
THT female header; 0.6 x 1.0 mm solder pin; angled; Pin spacing 7.5 mm; 6-pole; gray www.wago.com/232-836/005-000



Item no.: 232-836/005-000/039-000
THT female header; 0.6 x 1.0 mm solder pin; angled; Locking lever; Pin spacing 7.5 mm; 6-pole; gray www.wago.com/232-836/005-000/039-000















Item no.: 232-840/005-000
THT female header; 0.6 x 1.0 mm solder pin; angled; Pin spacing 7.5 mm; 10-pole; gray www.wago.com/232-840/005-000



Item no.: 232-842/005-000
THT female header; 0.6 x 1.0 mm solder pin; angled; Pin spacing 7.5 mm; 12-pole; gray www.wago.com/232-842/005-000

Item no.: 722-132/005-000

Subject to changes.

	Female connector for rail-mount terminal blocks; 0.6 x 1 mm pins; straight; 100% protected against mismatching; Pin spacing 5 mm; 2-pole; light gray	www.wago.com/722-132/005-000
	Item no.: 722-132/005-000/039-000 Female connector for rail-mount terminal blocks; 0.6 x 1 mm pins; straight; 100% protected against mismatching; Locking lever; Pin spacing 5 mm; 2-pole; light gray	www.wago.com/722-132/005-000/039-000
	Item no.: 722-133/005-000 Female connector for rail-mount terminal blocks; 0.6 x 1 mm pins; straight; 100% protected against mismatching; Pin spacing 5 mm; 3-pole; light gray	www.wago.com/722-133/005-000
	Item no.: 722-133/005-000/039-000 Female connector for rail-mount terminal blocks; 0.6 x 1 mm pins; straight; 100% protected against mismatching; Locking lever; Pin spacing 5 mm; 3-pole; light gray	www.wago.com/722-133/005-000/039-000
	Item no.: 722-134/005-000 Female connector for rail-mount terminal blocks; 0.6 x 1 mm pins; straight; 100% protected against mismatching; Pin spacing 5 mm; 4-pole; light gray	www.wago.com/722-134/005-000
	Item no.: 722-134/005-000/039-000 Female connector for rail-mount terminal blocks; 0.6 x 1 mm pins; straight; 100% protected against mismatching; Locking lever; Pin spacing 5 mm; 4-pole; light gray	www.wago.com/722-134/005-000/039-000
	Item no.: 722-135/005-000 Female connector for rail-mount terminal blocks; 0.6 x 1 mm pins; straight; 100% protected against mismatching; Pin spacing 5 mm; 5-pole; light gray	www.wago.com/722-135/005-000
	Item no.: 722-135/005-000/039-000 Female connector for rail-mount terminal blocks; 0.6 x 1 mm pins; straight; 100% protected against mismatching; Locking lever; Pin spacing 5 mm; 5-pole; light gray	www.wago.com/722-135/005-000/039-000
	Item no.: 722-136/005-000 Female connector for rail-mount terminal blocks; 0.6 x 1 mm pins; straight; 100% protected against mismatching; Pin spacing 5 mm; 6-pole; light gray	www.wago.com/722-136/005-000
	Item no.: 722-136/005-000/039-000 Female connector for rail-mount terminal blocks; 0.6 x 1 mm pins; straight; 100% protected against mismatching; Locking lever; Pin spacing 5 mm; 6-pole; light gray	www.wago.com/722-136/005-000/039-000
	Item no.: 722-137/005-000 Female connector for rail-mount terminal blocks; 0.6 x 1 mm pins; straight; 100% protected against mismatching; Pin spacing 5 mm; 7-pole; light gray	www.wago.com/722-137/005-000
	Item no.: 722-137/005-000/039-000 Female connector for rail-mount terminal blocks; 0.6 x 1 mm pins; straight; 100% protected against mismatching; Locking lever; Pin spacing 5 mm; 7-pole; light gray	www.wago.com/722-137/005-000/039-000
	Item no.: 722-138/005-000 Female connector for rail-mount terminal blocks; 0.6 x 1 mm pins; straight; 100% protected against mismatching; Pin spacing 5 mm; 8-pole; light gray	www.wago.com/722-138/005-000
	Item no.: 722-138/005-000/039-000	

Subject to changes.



Female connector for rail-mount terminal blocks; 0.6 x 1 mm pins; straight; 100% protected against mismatching; Locking lever; Pin spacing 5 mm; 8-pole; light gray

www.wago.com/722-138/005-000/039-000



Item no.: 722-139/005-000

Female connector for rail-mount terminal blocks; 0.6 x 1 mm pins; straight; 100% protected against mismatching; Pin spacing 5 mm; 9-pole; light gray

www.wago.com/722-139/005-000



Item no.: 722-139/005-000/039-000

Female connector for rail-mount terminal blocks; 0.6 x 1 mm pins; straight; 100% protected against mismatching; Locking lever; Pin spacing 5 mm; 9-pole; light gray

www.wago.com/722-139/005-000/039-000



Item no.: 722-140/005-000

Female connector for rail-mount terminal blocks; 0.6 x 1 mm pins; straight; 100% protected against mismatching; Pin spacing 5 mm; 10-pole; light gray

www.wago.com/722-140/005-000



Item no.: 722-140/005-000/039-000

Female connector for rail-mount terminal blocks; 0.6 x 1 mm pins; straight; 100% protected against mismatching; Locking lever; Pin spacing 5 mm; 10-pole; light gray

www.wago.com/722-140/005-000/039-000



Item no.: 722-141/005-000

Female connector for rail-mount terminal blocks; 0.6 x 1 mm pins; straight; 100% protected against mismatching; Pin spacing 5 mm; 11-pole; light gray

www.wago.com/722-141/005-000



Item no.: 722-142/005-000

Female connector for rail-mount terminal blocks; 0.6 x 1 mm pins; straight; 100% protected against mismatching; Pin spacing 5 mm; 12-pole; light gray

www.wago.com/722-142/005-000



Item no.: 722-142/005-007/039-000

Female connector for rail-mount terminal blocks; gray

www.wago.com/722-142/005-007/039-000



Item no.: 722-143/005-000

Female connector for rail-mount terminal blocks; 0.6 x 1 mm pins; straight; 100% protected against mismatching; Pin spacing 5 mm; 13-pole; light gray

www.wago.com/722-143/005-000



Item no.: 722-144/005-000

Female connector for rail-mount terminal blocks; 0.6 x 1 mm pins; straight; 100% protected against mismatching; Pin spacing 5 mm; 14-pole; light gray

www.wago.com/722-144/005-000



Item no.: 722-144/005-000/039-000

Female connector for rail-mount terminal blocks; 0.6 x 1 mm pins; straight; 100% protected against mismatching; Locking lever; Pin spacing 5 mm; 14-pole; light gray

www.wago.com/722-144/005-000/039-000



Item no.: 722-145/005-000

Female connector for rail-mount terminal blocks; 0.6 x 1 mm pins; straight; 100% protected against mismatching; Pin spacing 5 mm; 15-pole; light gray

www.wago.com/722-145/005-000



Item no.: 722-146/005-000

Female connector for rail-mount terminal blocks; 0.6 x 1 mm pins; straight; 100% protected against mismatching; Pin spacing 5 mm; 16-pole; light gray

www.wago.com/722-146/005-000

Item no.: 722-146/005-000/039-000

Subject to changes.

WAGO Kontakttechnik GmbH & Co. KG

Hansastr. 27













32423 Minden

Phone: +49571 887-0 | Fax: +49571 887-169













Email: info.de@wago.com | Web: www.wago.com

Do you have any questions about our products?

We are always happy to take your call at +49 (571) 887-44222.

	Female connector for rail-mount terminal blocks; 0.6 x 1 mm pins; straight; 100% protected against mismatching; Locking lever; Pin spacing 5 mm; 16-pole; light gray	www.wago.com/722-146/005-000/039-000
	Item no.: 722-150/005-000 Female connector for rail-mount terminal blocks; 0.6 x 1 mm pins; straight; 100% protected against mismatching; Pin spacing 5 mm; 20-pole; light gray	www.wago.com/722-150/005-000
	Item no.: 722-150/005-000/039-000 Female connector for rail-mount terminal blocks; 0.6 x 1 mm pins; straight; 100% protected against mismatching; Locking lever; Pin spacing 5 mm; 20-pole; light gray	www.wago.com/722-150/005-000/039-000
	Item no.: 722-232/005-000 Female connector for rail-mount terminal blocks; 0.6 x 1 mm pins; angled; 100% protected against mismatching; Pin spacing 5 mm; 2-pole; light gray	www.wago.com/722-232/005-000
	Item no.: 722-232/005-000/039-000 Female connector for rail-mount terminal blocks; 0.6 x 1 mm pins; angled; 100% protected against mismatching; Locking lever; Pin spacing 5 mm; 2-pole; light gray	www.wago.com/722-232/005-000/039-000
	Item no.: 722-233/005-000 Female connector for rail-mount terminal blocks; 0.6 x 1 mm pins; angled; 100% protected against mismatching; Pin spacing 5 mm; 3-pole; light gray	www.wago.com/722-233/005-000
	Item no.: 722-233/005-000/039-000 Female connector for rail-mount terminal blocks; 0.6 x 1 mm pins; angled; 100% protected against mismatching; Locking lever; Pin spacing 5 mm; 3-pole; light gray	www.wago.com/722-233/005-000/039-000
	Item no.: 722-234/005-000 Female connector for rail-mount terminal blocks; 0.6 x 1 mm pins; angled; 100% protected against mismatching; Pin spacing 5 mm; 4-pole; light gray	www.wago.com/722-234/005-000
	Item no.: 722-234/005-000/039-000 Female connector for rail-mount terminal blocks; 0.6 x 1 mm pins; angled; 100% protected against mismatching; Locking lever; Pin spacing 5 mm; 4-pole; light gray	www.wago.com/722-234/005-000/039-000
	Item no.: 722-235/005-000 Female connector for rail-mount terminal blocks; 0.6 x 1 mm pins; angled; 100% protected against mismatching; Pin spacing 5 mm; 5-pole; light gray	www.wago.com/722-235/005-000
	Item no.: 722-235/005-000/039-000 Female connector for rail-mount terminal blocks; 0.6 x 1 mm pins; angled; 100% protected against mismatching; Locking lever; Pin spacing 5 mm; 5-pole; light gray	www.wago.com/722-235/005-000/039-000
	Item no.: 722-236/005-000 Female connector for rail-mount terminal blocks; 0.6 x 1 mm pins; angled; 100% protected against mismatching; Pin spacing 5 mm; 6-pole; light gray	www.wago.com/722-236/005-000
	Item no.: 722-236/005-000/039-000 Female connector for rail-mount terminal blocks; 0.6 x 1 mm pins; angled; 100% protected against mismatching; Locking lever; Pin spacing 5 mm; 6-pole; light gray	www.wago.com/722-236/005-000/039-000
	Item no.: 722-237/005-000	

Subject to changes.

	Female connector for rail-mount terminal blocks; 0.6 x 1 mm pins; angled; 100% protected against mismatching; Pin spacing 5 mm; 7-pole; light gray	www.wago.com/722-237/005-000
	Item no.: 722-237/005-000/039-000 Female connector for rail-mount terminal blocks; 0.6 x 1 mm pins; angled; 100% protected against mismatching; Locking lever; Pin spacing 5 mm; 7-pole; light gray	www.wago.com/722-237/005-000/039-000
	Item no.: 722-238/005-000 Female connector for rail-mount terminal blocks; 0.6 x 1 mm pins; angled; 100% protected against mismatching; Pin spacing 5 mm; 8-pole; light gray	www.wago.com/722-238/005-000
	Item no.: 722-239/005-000 Female connector for rail-mount terminal blocks; 0.6 x 1 mm pins; angled; 100% protected against mismatching; Pin spacing 5 mm; 9-pole; light gray	www.wago.com/722-239/005-000
	Item no.: 722-239/005-000/039-000 Female connector for rail-mount terminal blocks; 0.6 x 1 mm pins; angled; 100% protected against mismatching; Locking lever; Pin spacing 5 mm; 9-pole; light gray	www.wago.com/722-239/005-000/039-000
	Item no.: 722-240/005-000 Female connector for rail-mount terminal blocks; 0.6 x 1 mm pins; angled; 100% protected against mismatching; Pin spacing 5 mm; 10-pole; light gray	www.wago.com/722-240/005-000
	Item no.: 722-240/005-000/039-000 Female connector for rail-mount terminal blocks; 0.6 x 1 mm pins; angled; 100% protected against mismatching; Locking lever; Pin spacing 5 mm; 10-pole; light gray	www.wago.com/722-240/005-000/039-000
	Item no.: 722-241/005-000 Female connector for rail-mount terminal blocks; 0.6 x 1 mm pins; angled; 100% protected against mismatching; Pin spacing 5 mm; 11-pole; light gray	www.wago.com/722-241/005-000
	Item no.: 722-242/005-000 Female connector for rail-mount terminal blocks; 0.6 x 1 mm pins; angled; 100% protected against mismatching; Pin spacing 5 mm; 12-pole; light gray	www.wago.com/722-242/005-000
	Item no.: 722-242/005-000/039-000 Female connector for rail-mount terminal blocks; 0.6 x 1 mm pins; angled; 100% protected against mismatching; Locking lever; Pin spacing 5 mm; 12-pole; light gray	www.wago.com/722-242/005-000/039-000
	Item no.: 722-243/005-000 Female connector for rail-mount terminal blocks; 0.6 x 1 mm pins; angled; 100% protected against mismatching; Pin spacing 5 mm; 13-pole; light gray	www.wago.com/722-243/005-000
	Item no.: 722-244/005-000 Female connector for rail-mount terminal blocks; 0.6 x 1 mm pins; angled; 100% protected against mismatching; Pin spacing 5 mm; 14-pole; light gray	www.wago.com/722-244/005-000
	Item no.: 722-244/005-000/039-000 Female connector for rail-mount terminal blocks; 0.6 x 1 mm pins; angled; 100% protected against mismatching; Locking lever; Pin spacing 5 mm; 14-pole; light gray	www.wago.com/722-244/005-000/039-000

Item no.: 722-246/005-000

Subject to changes.



Female connector for rail-mount terminal blocks; 0.6 x 1 mm pins; angled; 100% protected against mismatching; Pin spacing 5 mm; 16-pole; light gray

www.wago.com/722-246/005-000



Item no.: 722-246/005-000/039-000

Female connector for rail-mount terminal blocks; 0.6 x 1 mm pins; angled; 100% protected against mismatching; Locking lever; Pin spacing 5 mm; 16-pole; light gray

www.wago.com/722-246/005-000/039-000



Item no.: 722-250/005-000

Female connector for rail-mount terminal blocks; 0.6 x 1 mm pins; angled; 100% protected against mismatching; Pin spacing 5 mm; 20-pole; light gray

www.wago.com/722-250/005-000

Downloads

Documentation

Bid Text

280-641 doc - Datei	Feb 28, 2017	doc 24.6 kB	Download
------------------------	--------------	----------------	----------

280-641 X81 - Datei	Feb 19, 2019	xml 3.4 kB	Download
------------------------	--------------	---------------	----------

Additional Information

Technical explanations	Apr 3, 2019	pdf 2.1 MB	Download
------------------------	-------------	---------------	----------

CAD/CAE-Data

CAD data

2D/3D Models 280-641	URL	Download
----------------------	-----	----------

CAE data

EPLAN Data Portal 280-641	Download
---------------------------	----------

WSCAD Universe 280-641	Download
------------------------	----------

Installation Notes

Assembly

Subject to changes.

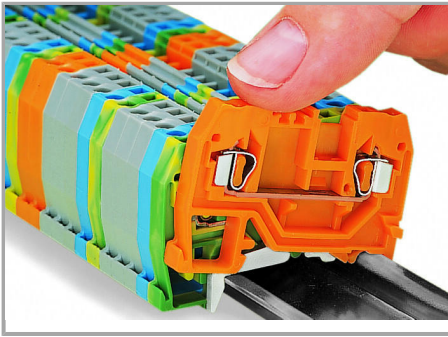

Snapping a terminal block onto the carrier rail.

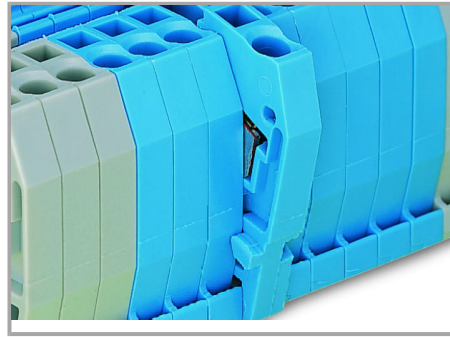

Quick assembly keys prevent reverse mounting.

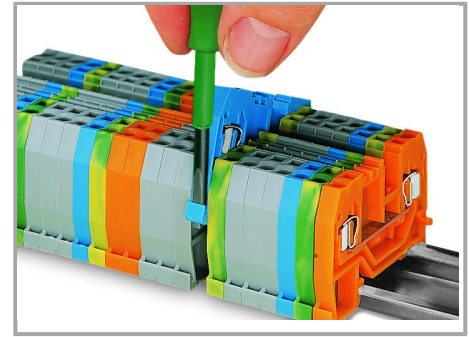

Removing a terminal block from the assembly.

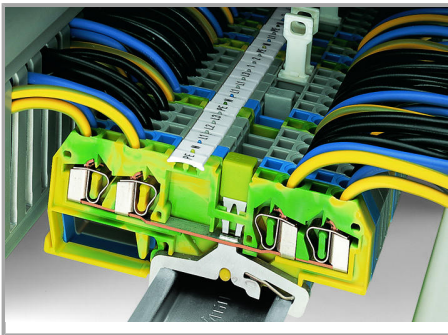

Steel carrier rails are not suited for PEN (ground and N-conductor) applications per EN 60947-7-2 (VDE 0611, Part 3).

Inserting a conductor

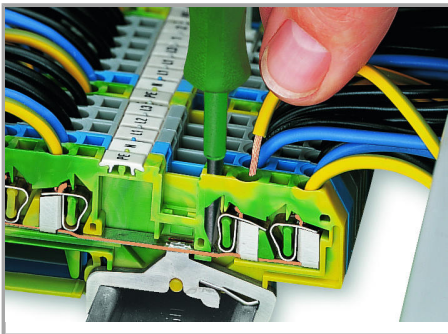

CAGE CLAMP® connection

Inserting a conductor.

Subject to changes.

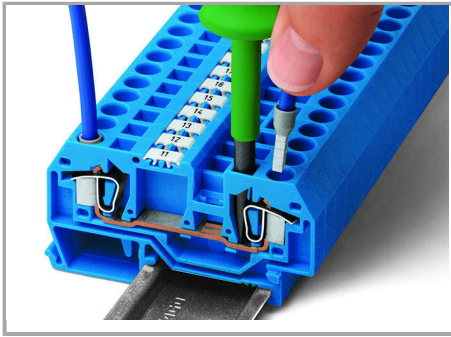

CAGE CLAMP® connection

Inserting a conductor.

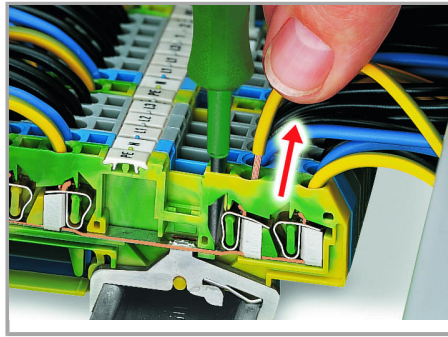

CAGE CLAMP®-Anschluss

Leiter lösen.

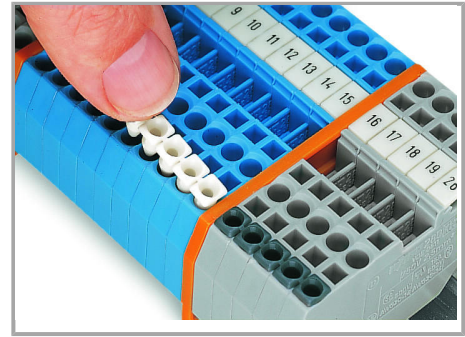

Inserting insulation stops.

With ferruled conductors, it is necessary to use a terminal block one size larger than the conductor's nominal cross-section.

Jumpered

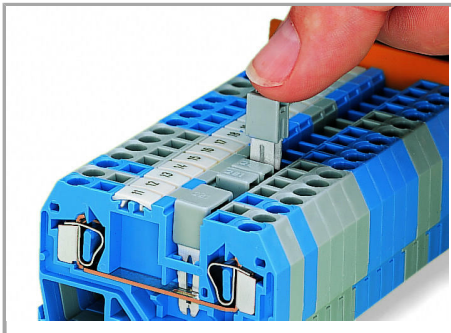

Commoning using an adjacent jumper (280-402).

Push jumper down until fully inserted.

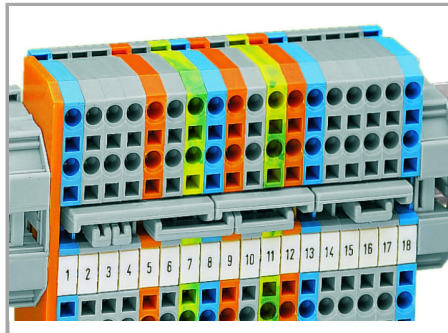

Staggered jumpers for sophisticated circuit requirements – push jumpers down until fully inserted.

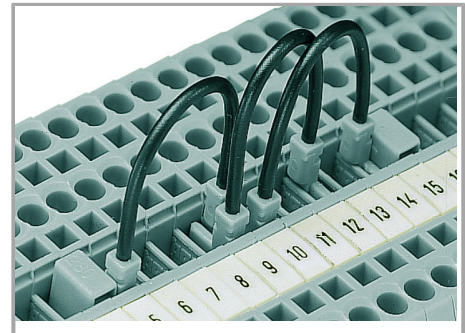

Wire jumpers

When installing machines or control systems, it is often necessary to make an additional connection between two terminal blocks that are not next to each other on the rail. In such cases, WAGO's touch-proof, push-in type wire jumpers are the ideal solution.

Subject to changes.



These jumpers are compatible with the following rail-mount terminal blocks:

- 279 Series (1.5 mm²/16 AWG),
-
- 280/775/780 Series (2.5 mm²/14 AWG)
-
- 281/769/776/777/781 and 880 Series (4 mm²/12 AWG)
-

They are available in three conductor lengths (60, 110 and 250 mm), allowing up to 60 terminal blocks to be commoned depending on their width (see table on the right).

Compared with the 279 Series, the 280/775/780 and 281/776/777/781 Series can also accommodate two wire jumpers, allowing the use of commoning chains. Furthermore, the 280/769/775/780/880 and 281/776/777/781 Series allow both wire jumper and adjacent jumper to be simultaneously plugged into a same terminal block.

Subject to changes.

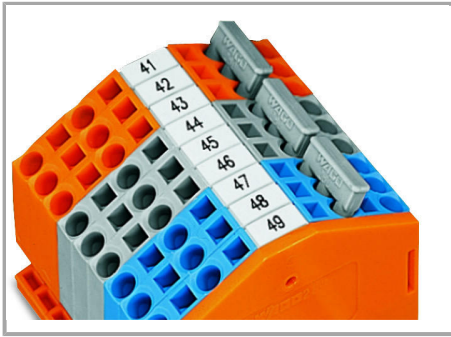

4-conductor through terminal blocks, angled type –

formation of groups with 3-way, comb-style jumper bars

Testing

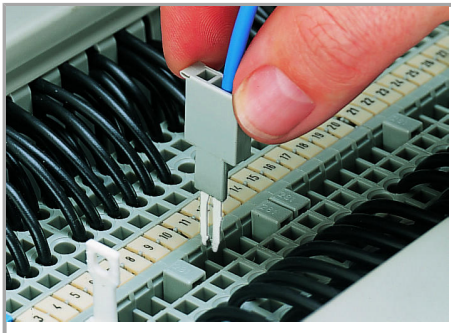

Testing with a test plug

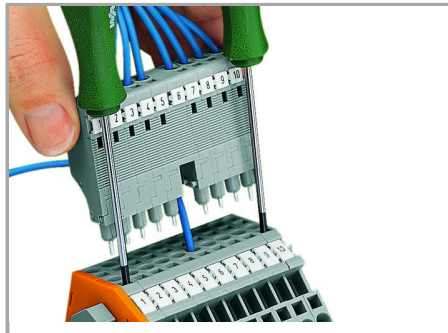

L-type test plug modules fitted with CAGE CLAMP®

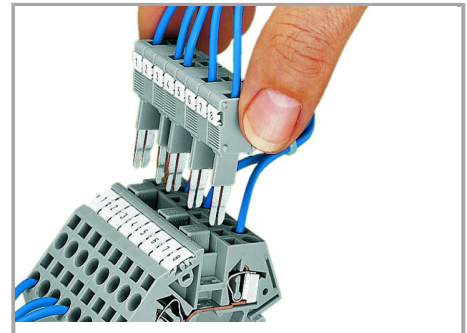

B-type test plug modules fitted with CAGE CLAMP®

(picture shows a test plug fitted with CAGE CLAMP®).

Subject to changes.

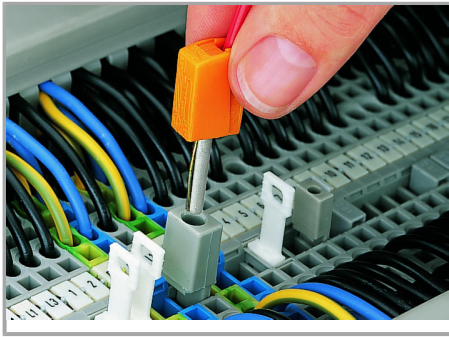

Testing with a test plug

(picture shows 209-170 Test Plug Adapter).

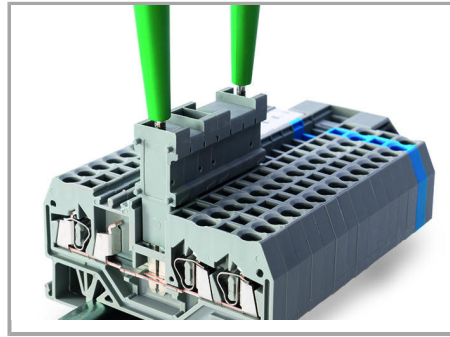

The test plug modules are directly plugged into the jumper contact slot of the current bar.

Cover

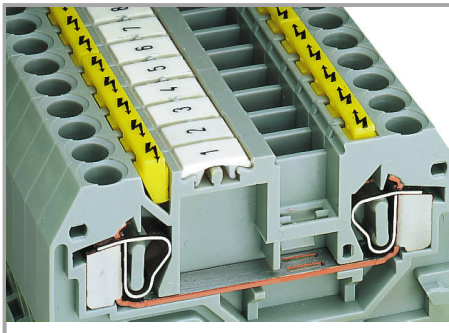

Protective warning markers inserted into the operating slots.

Subject to changes.