



MARINCO®

2 0 1 9

MARINE
EMERGENCY VEHICLE
INDUSTRIAL
RV

Shore Power
DC Power Connections
Power Conversion
Battery Management
Wiper Systems
Horns
Lighting
Ventilation

For decades Ancor, BEP, Blue Sea Systems, CZone, Lenco, Marincó, Mastervolt and ProMariner have worked independently to provide innovative electrical products. Now the eight companies are working together to offer comprehensive electrical solutions for marine and mobile applications.

Providing more than products. Providing Solutions.

ANCOR
Wire & Cable
Terminals & Lugs
Wire Management
Tools & Testers
Lighting
ancorproducts.com

BEP
Battery Management
Connectors & Insulators
Circuit Protection
Power Distribution Panels
Custom Panels & Design Services
Meters
bepmarine.com

BLUE SEA SYSTEMS
Power Conversion & Connection
Battery Management
Circuit Protection & Switches
Connectors & Insulators
Power Distribution
Custom Panels
Meters
blueseasystems.com

CZONE
Digital Control & Monitoring
Accessories
Integrated Solutions
czone.net

LENCO
Electric Trim Tabs
Auto Glide Automatic Boat Leveling
Tactile Switch Kits
Rocker Switch Kits
Electric Hatch Lifts
Actuators & Accessories
Trim Tab Retrofit Kits
lencmarine.com

ProMariner™
Waterproof Battery Chargers
Vented Battery Chargers
Inverters
Inverter / Chargers
Isolators
Accessories
promariner.com

MASTERVOLT
Battery Chargers
Inverters
Inverter / Chargers
Batteries
Digital Control & Monitoring
Transformers
Alternators & Regulators
mastervolt.us

MARINCO
Shore Power
DC Power Connections
Power Conversion
Battery Management
Wiper Systems
Horns
Lighting
Ventilation
marinco.com



What makes Marinco different:

Founder's Vision

Since 1972, Marinco power inlets and cords have set the industry standard. They are built to withstand the harshest marine environments. Marinco has continued to expand their product line to offer a complete range of shore power cords from 16 to 100 amps, as well as a broad range of cord adapters. Marinco is also a leading supplier of wipers, spotlights and horns to the marine industry. Quality, innovation, and our passion for boating are what define Marinco.

Innovation & Engineering

Marinco engineers and manufactures a range of high quality electrical solutions designed for the harsh Marine and RV environments. Every product we make meets exacting performance specifications and is designed to withstand extreme conditions both at sea, and on land.

Selection

Over 800 electrical products are designed to work together as a system

Fast Delivery

Products stocked in multiple global locations ensures rapid order fulfillment

Worldwide Access to Product

A distribution network in over 45 countries provides access to products when they are needed

Information

24-hour access to product information, selection tools, and technical articles online at marinco.com

Industry Standards

Industry involvement ensures products meet ABYC, NMMA, and Coast Guard standards

Quality

Product quality is managed in a manner consistent with international standards



2018–2019 **NEW** Products



20 15A 12/3 Heavy-duty Extension Cords

Part # 151225 25 ft
Part # 151250 50 ft

Heavy-duty marine-grade cable with robust, fully molded ends for use in harsh environments.



25 Gray Pigtail Adapters

Part # 104SPPG 15A Plug to 30A Connector
Part # 105SPPG 30A Plug to 15A Connector

Allows waterproof connection of inlets and cords. Adapters are fully molded with a sealing collar for use in wet locations and contain LED lights for visual power indication.



36 100 Amp Cordsets

New line of Maringo 100 amp cordsets are for use with or without on-board isolation transformers, as male plug only power supply, and extension cord applications. Constructed with watertight and corrosion resistant plugs and connectors, and oil, water, and UV resistant cable, rated to 105°C.



48 Guest ChargePro™ On-Board Battery Chargers

Part # 2708A	5A	Part # 2713A	15A
Part # 2707A	8A	Part # 2720A	20A
Part # 2710A	10A	Part # 2731A	30A
Part # 2711A	10A	Part # 2740A	40A

New line of Guest chargers ranging from 5 to 40 amps, with fully automatic 5-Stage performance charging for 12 volt lead acid and AGM batteries. Chargers have dedicated outputs, aluminum housings and expanded LED charge status. 100% waterproof and shock resistant for all fresh and salt water applications.

2018-2019 **NEW** Products



74 Deluxe Stainless Steel Wiper Blades

New higher quality stainless steel wiper blades now offered in 12"-26" lengths, in both SS and black colors.



75 Intermittent Wiper Motor Controller

Part # 76090 OEM # 76190 Single Speed
Part # 76080 OEM # 76180 Dual Speed

Synchronized control of single or dual speed 12V/24V wiper systems, features intuitive automotive style functionality. Easy to use with included Contura switch, and easy to install with ¼" spade connectors. IP67 potted construction for harsh environment durability.



89 IP67 LED Stainless Steel Spotlight

Part # 23050A Spotlight with Remote
Part # 23051A Spotlight Only

IP67 Stainless Spotlight features a 7", 12 LED array, and IP67 stainless construction. Creates approx. 3 times concentrated spot diameter while drawing roughly half the power of comparable halogen spotlights. Wireless communication using mounted bridge or hand held remote.



96 Solar Vent Cap for Day/Night Solar Vents

Part # N20803CAP For 3" Vents
Part # N20804CAP For 4" Vents

Twist-in sealing cap for use when the New Day/Night Solar Vent is removed from the deck surface. Available for both vent sizes, 3" and 4".



96 Replacement Trim Ring for Day/Night Solar Vents

Part # N20803RING For 3" Vents
Part # N20804RING For 4" Vents

Threaded trim ring replacements for deck surface mounting or interior trim use. Available for the New 3" and 4" Day/Night Solar Vents.

Table of Contents

SHORE POWER

Dock Side to Boat Side Selection Guide	10
Inlets	12
Cordsets	18
Extension Cords	20
Adapters	22
Devices & Accessories	28
Boxes / Covers / Replacement Parts	32
16A Shore Power Systems	33
32A Shore Power Systems	34
63A Shore Power Systems	35
100A Shore Power Systems	36



DC POWER CONNECTIONS

12V Receptacles / Plugs / Accessories	40
Charging / Trolling Systems	43



POWER CONVERSION

Battery Chargers	48
Battery Charger Inlets	51



BATTERY MANAGEMENT

Dynaplates	54
Battery Switches	55



WIPER SYSTEMS

Wiper Motors	60
Wiper Motors Kits	68
Wiper Arms	69
Wiper Blades	72
Wiper System Accessories	75



HORNS

Hidden Horns	79
Compact Horns	83
Trumpet Horns	84



LIGHTING

Spot Lights	88
Deck Lamps	91
Docking Lights	91



VENTILATION

Solar Vents	94
Cowl & Clam Shell Vents	98
Deck Plates	99
Fans	100



INDEX

Part Number Index	101
-------------------	-----

SHORE POWER

Inlets

12



Marinco® Power Inlets are the industry standard. Offered in three styles, featuring robust construction and corrosion-resistant materials for long life in the harsh marine environment. All inlets have an IP56 rating.

Cordsets

18



All Marinco® cordsets are made of the highest quality, marine grade construction with features you won't find on other power cords.

15A Marine Grade Locking Extension Cords

20



15 Amp extension cords contain a universal slide locking mechanism to prevent cable disconnection. Available in 25' and 50' lengths.

Cordset Accessories

21



Marinco offers everything you need to manage your shore power equipment.

SHORE POWER

Adapters



Marinco® Shore Power Adapters give you more power hook-up flexibility and resolve a variety of dock side power center / boat side inlet power incompatibility problems.

Devices & Accessories



Everything you need to maintain and repair your shore power equipment.

International Shore Power



Marinco offers inlets, connectors and cordsets for 16 Amp, 32 Amp and 63 Amp Shore Power systems.

100 Amp Shore Power



Marinco 100 amp cordsets are for use with or without on-board isolation transformers, as male plug only power supply, and extension cord applications. Constructed with watertight and corrosion resistant plugs and connectors, and oil, water, and UV resistant cable, rated to 105°C.



Marinco® power inlets and cords have been the industry standard and are designed and built to withstand the rigors of the marine environment.

Marinco® Dock Side to Boat Side Selection Guide

DOCK SIDE

Marine Receptacles
(pg 28-30)
Corrosion resistant reinforced nylon construction.

Weatherproof Covers
(pg 32)
Yellow LEXAN® polycarbonate with lift lid, for use with Marinco® receptacles.

Male Plugs
(pg 28-30)
Superior strain-relief system. Dust seal keeps contaminants out of terminals.

Weatherproof Covers
(pg 28-31)
Heavy duty vinyl construction, use with male plugs for superior seal.

30A
125V
2 Pole
3 Wire
Locking



50A
125V
2 Pole
3-Wire
Locking



50A
125/250V
2 Pole
4-Wire
Locking



**Cable TV/
Internet**



Marinco® Color Coding System

15A 125V	20A 125V	30A 125V	50A 125V	50A 125/250V	Cable TV Internet
-------------	-------------	-------------	-------------	-----------------	-------------------------

BOAT SIDE

Shore Power Cord Sets

(pg 18-19)

Marine grade cable, watertight molded plug and connector, line-up ridge for easy blade alignment.

Weatherproof Covers

(pg 28-31)

Heavy duty vinyl construction, use with female connector for superior seal.

Female Connectors

(pg 28-30)

Ribbed nylon construction, color coded terminal pockets and screws.

Power Inlets

(pg 13-15, 20)

Styled to complement any boat, Marinco® power inlets are simple to install and feature a protective rear safety enclosure that provides safe, reliable strain relief. IP56 rated.



CS30-50



103ELN



305CRCN



CS503-50



7715CRN



6360CRN



CS504-50



7715CRN



6364CRN



TVHD



PH6629



Inlets

Marinco® Power Inlets are the industry standard. Offered in three styles, they all feature robust construction and corrosion-resistant materials for long life in the harsh marine environment. Each has technical features that make them easy to install and a pleasure to use for the marine professional or the casual recreational boater. All inlets have an IP56 rating.



Stainless Steel

Marinco® stainless steel inlets are solid cast marine grade 316 stainless steel and include a heavy duty cap strap for strength and durability.



Contoured

Marinco® contoured inlets feature UV stabilized glass-filled polyester construction for long-lasting strength.



Standard

Marinco® standard inlets feature UV stabilized glass-filled polyester construction for long-lasting strength.



Easy Lock™ Sealing Ring
(sold separately)
page 29

- ❶ Easy Lock™—Marinco's exclusive Easy Lock™ System has been designed to connect the cordset (with an Easy Lock™ sealing ring installed) to the inlet and turn the locking ring less than a quarter turn. The tabs on the locking ring lock into the inlet for a positive watertight hook-up while eliminating any chance of cross threading. Easy Lock™ inlets have a threaded boss that will accept standard threaded cordsets as well.
- ❷ The covers on all Marinco inlets are designed to stay hinged open when the cover is lifted up. This allows the boater to connect their shore power cord while the cover remains open and out of the way. A soft touch unlocks it for closing.
- ❸ Blades are nickel plated brass for maximum corrosion resistance.
- ❹ Interior hardware is marine grade stainless steel.
- ❺ **IMPROVED** Extra large tab provides more area to simplify opening and closing.
- ❻ **Rear Enclosure**
 - Made of flame-resistant UL94V0 plastic.
 - All rear enclosures are glass-filled polyester for strength.
 - Integral strain relief complies with ABYC requirements.
 - Multiple positions allow for maximum installation flexibility.



30A 125V 30 Amp 125V Inlets

IP56 NEMA L5-30P  30A 125V Locking **Meets or Exceeds ABYC Standards**  



Stainless Steel Power Inlet
 • Cast 316 stainless steel
 Part # 303SSEL-B
 OEM # 303SSEL-B.OEM



Contour Power Inlet
 • Stainless steel trim
 Part # 304EL-B
 OEM # 304EL-B.OEM



Contour Power Inlet
 • Without stainless steel trim
 OEM # 304EL-B.NT white
 OEM # 199136 black



Power Inlet
 • Stainless steel trim
 Part # 301EL-B white
 OEM # 301EL-B.OEM white
 Part # 301ELCB replacement cap & bezel



Power Inlet
 • Stainless steel trim
 Part # 301EL-B.GRAY gray
 Part # 301EL-B.BLACK black



Power Inlet
 • ABYC shore power warning label on cap
 Part # 301EL-B.W/L



Power Inlet
 • Stainless steel trim
 • Hole in rear enclosure accommodates snap-in strain relief (not included)
 Part # 301EL-B.FR



Breaker Inlet
 • Includes cap & bezel and breaker plate
 • Breaker not included
 Part # 3050BI



Stainless Steel Power Outlet
 • Female 30A 125V configuration
 • NEMA configuration L5-30R
 Part # 303SSO

50A
125V**50 Amp 125V Inlets****IP56**NEMA
SS1-50PW 50A
125V
LockingMeets or Exceeds
ABYC
Standards**Stainless Steel
Power Inlet**

- Cast 316 stainless steel

Part # 6371EL-B

OEM # 6371EL-B.OEM

**Stainless Steel
Power Inlet**

- Cast 316 stainless steel
- Without rear safety enclosure

Part # 6371EL

**Power Inlet**

- Stainless steel trim
- Without rear safety enclosure

Part # 6351EL

**Power Inlet**

- Without stainless steel trim
- ABYC shore power warning label on cap

Part # 6351EL-B

**Contour Power Inlet**

- Stainless steel trim

Part # 6343EL-B

TECH tip™**50A Devices Explained**

There are two categories of 50A devices: 50A 125V (50A 3-wire) and 50A 125/250V (50A 4-wire). The 4-wire devices have two "hot" legs, each carrying 50A 125V. These two categories are not interchangeable. A 3-wire plug must never be altered to insert into a 4-wire connector or receptacle.

50A
125/250V

50 Amp 125/250V Inlets

IP56

NEMA
SS2-50P



50A
125/250V
Locking

Meets or Exceeds
ABYC
Standards



Stainless Steel Power Inlet

- Cast 316 stainless steel

Part # 6373EL-B
OEM # 6373EL-B.OEM
Part # 6373EL-B.W/L

w/separate warning label



Stainless Steel Power Inlet

- Cast 316 stainless steel
- Without rear safety enclosure

Part # 6373EL
OEM # 6373EL.OEM



Contour Chrome Power Inlet

- Chrome finish cover

OEM # 6344EL-BCR.OEM



Contour Power Inlet

- Without stainless steel trim

Part # 6344EL-B.NT



Power Inlet

- Stainless steel trim

Part # 6353EL-B
OEM # 6353EL-B.OEM
Part # 6353ELCB

replacement cap & bezel



Power Inlet

- Stainless steel trim
- Black

OEM # 6353EL-B.BLACK.OEM



Power Inlet

- Stainless steel trim
- Gray

Part # 6353EL-B.GRAY



Power Inlet

- Stainless steel trim
- Without rear safety enclosure

Part # 6353EL

ELCI inlets

Marinco®'s solution to the ABYC E-11 requirement is based on our industry-standard marine inlets. We have taken the best available technology and built it into our inlets to provide boat builders and owners with the safest, best looking and most durable solution possible. All of our ELCI Inlets are ignition protected to comply with ABYC standards.

We provide two modules in addition to the standard inlet. One houses the ELCI Marine Sensing Module, the other the breaker. Unlike competing systems, our ELCI Marine sensing module has a 3/4" diameter coil that accepts up to three 6 gauge conductors. This sensing module, which also incorporates a test circuit, is compatible with 30A 125V, 50A 125V and 50A 125/250V systems. There is a different breaker for 30A and 50A systems.

TECH tip™

ELCI ABYC Standards

Electrical current leakage is a serious safety concern for any boat connected to shore power. Because of this ABYC requirements now include specific measures for avoiding this danger. ABYC E-11.11.1 states "An Equipment Leakage Circuit Interrupter (ELCI) shall be installed with or in addition to the main shore power disconnect circuit breaker(s) or at the additional overcurrent protection as required by E-11.10.2.8.3 whichever is closer to the shore power connection."

Single Phase 120V AC 30A (Hot, Neutral, Ground)

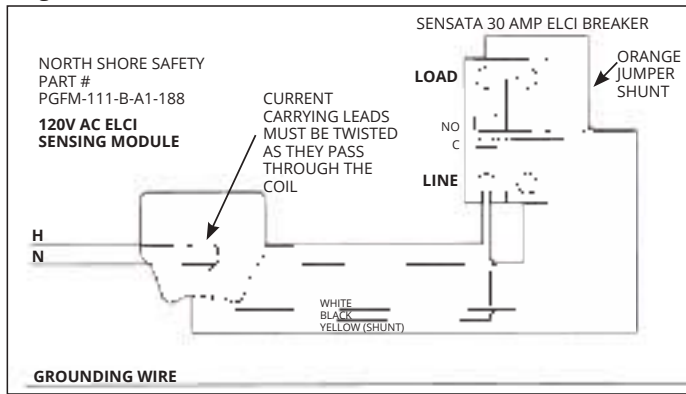

Split Phase 120/240V AC 50A (Line 1, Line 2, Neutral, Ground)

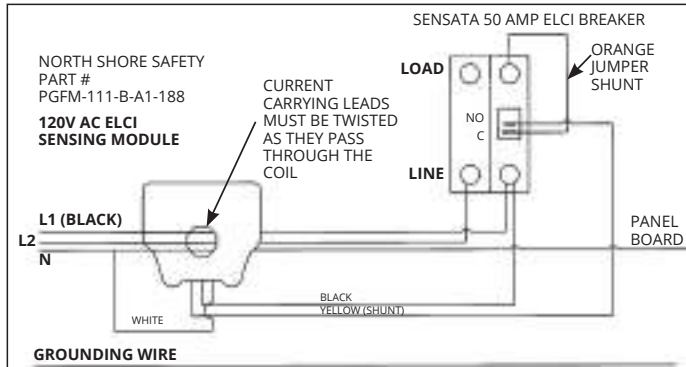

Standard Sensing Breaker & Module Kits

- Module & breaker packaged together

30A 120V AC Single Phase **OEM # 301RCDKITIGN.OEM**
 50A 120/240V AC Split Phase **OEM # 6353RCDKITIGN.OEM**



Stainless Steel Housing for Sensing Modules

- Cast 316 stainless steel
- OEM # 303SSRCDPL.OEM**

Stainless Steel Housing for 30A or 50A Sensing Breakers

- Cast 316 stainless steel
- OEM # 303SSBRPL.OEM**



Standard Housing for Sensing Modules

OEM # 301RCDPL.OEM

Standard Housing for 30A or 50A Sensing Breakers

OEM # 301BRPL.OEM

Cable TV / Internet

Cable TV / Internet



Stainless Steel Phone & Cable TV Inlet

- Cast 316 stainless steel

Part # PH6592TV-SS
OEM # PH6592TV-SS.OEM



Phone & Cable TV Inlet

- Stainless steel trim

Part # PH6574TV
Part # PH6574TV.W/L w/ warning label



Stainless Steel Cable TV / Internet Inlet

- Cast 316 stainless steel

Part # TV6592
OEM # TV6592.OEM



Cable TV / Internet Inlet

Part # TV6574



Contour Cable TV / Internet Inlet

Part # TV6444



Female Phone Plug

- MARINEGUARD II Cover

Part # PH6629



Telephone Adapter

- Use to hook up telephone to cordset PH6599. No inlet installation required.

Part # PH6600



Telephone Adapter

- Use to hook up a locking type inlet to a modular telephone connection

Part # PH6601



EEL Shore Power Cordsets

One Hand. A simple twist. Full Power.

The EEL (Easily Engaged Lock) Shore Power Cordset has a patented, industry first, jaw-clamp design providing one-handed operation and a secure waterproof seal which completely eliminates the need for a locking ring. The EEL connection is built for the harshest environments and is UL approved. This easy-to-use cordset features a built-in cord light which serves as an alert to boaters when the cord is left plugged in. And, best of all, it works with your current inlet. In addition to cordsets with the EEL System, Marinco® also has a full set of Pigtail and Y adapters all using the new EEL technology.

Patented EEL Technology:

- Designed for use with standard inlets (NEMA)
- Single-handed operation
- No sealing ring required
- Patented jaw-clamp technology provides a watertight seal every time

Features & Benefits:

- Built-in cord light for added safety – alert light indicates if you are plugged into the dock and cord is powered
- Power indicator light on both ends informs you full power is flowing through the cord
- Meets and exceeds rigorous UL testing standards
- 30 Amp and 50 Amp cordset models, 12', 25' and 50' lengths in white and yellow available
- EEL product line includes connectors, pigtail, straight and "Y" adapters



5 YEAR WARRANTY



Length	Color	Part #
30 Amp 125V Cordsets		
12'	yellow	CS30-12
25'	yellow	CS30-25
50'	yellow	CS30-50
50'	white	CS30-50W
50 Amp 125V Cordsets		
25'	yellow	CS503-25
50'	yellow	CS503-50
50 Amp 125/250V Cordsets		
25'	yellow	CS504-25
50'	yellow	CS504-50
50'	white	CS504-50W



30A 125V Locking



50A 125V Locking



50A 125/250V Locking

Amp	Volts	Plug	Connector
30A	125V AC	L5-30P	L5-30R
50A	125V AC	SS1-50P	SS1-50R
50A	125/250V AC	SS2-50P	SS2-50R



CS504-50W

CS30-50

TECH tip™

Blade Function Letter Codes

- | | |
|------------------|----------------------|
| G Ground | X Phase 1 Hot |
| W Neutral | Y Phase 2 Hot |

Power Cord Plus® Cordsets

All Marinco® cordsets are made of the highest quality, marine grade construction with features you won't find on other power cords.

- 1 Watertight molded plug and connector for safety and durability
- 2 Heavy duty, super flexible marine grade cable (30 amp 10 gauge, 50 amp 6 gauge)
- 3 All models include a standard threaded ring for hook-up to ordinary threaded inlets
- 4 Corrosion resistant, nickel plated contacts
- 5 Power Indicator Light: Boat side connector features a molded-in LED light. When it glows red, you know you have power to the boat.
- 6 Contour Grip with Thumbprint Locator: Both plug and connector ends are molded to fit the contour of your hand. When the thumbprint is in the 12 o'clock position, the blades line up for easy connection.
- 7 Marinco's Easy Lock™ system: Quickly locks the cord set to the inlet in just 1/8 of a turn. The exclusive locking tabs engage slots built into all Marinco inlets (sold separately).



Easy Lock™ system



5 YEAR WARRANTY



Length	Color	Pkg	Part #	OEM #
30 Amp Power Cord Plus® Cordsets				
12 ft	yellow	sleeve pack	199116	—
25 ft	yellow	sleeve pack	199117	—
25 ft	white	sleeve pack	25SPPW	—
25 ft	gray	sleeve pack	199117G	—
35 ft	yellow	sleeve pack	35SPP	—
50 ft	yellow	sleeve pack	199119	50SPP.OEM
50 ft	white	sleeve pack	199120	50SPPW.OEM
50 ft	gray	sleeve pack	199119G	—
75 ft	yellow	box	—	75SPP.OEM
50 Amp 125 Volt Power Cord Plus® Cordsets (3-Wire)				
25 ft	yellow	box	6153SPP-25	—
50 ft	yellow	box	6153SPP	—
50 ft	white	box	6153SPPW	—
75 ft	yellow	box	6153SPP-75	—
50 Amp 125/250 Volt PowerCord Plus® Cordsets (4-Wire)				
12 ft	yellow	box	6152SPP-12SC	—
25 ft	yellow	box	6152SPP-25	—
25 ft	white	box	6152SPPW-25	—
25 ft	gray	box	6152SPPG-25	—
40 ft	yellow	box	6152SPP-40	—
50 ft	yellow	box	6152SPP	—
50 ft	white	box	6152SPPW	—
50 ft	gray	box	6152SPPG	—
75 ft	yellow	box	6152SPP-75	—
50 Amp Plug End Only Cordsets				
55 ft	white	box	6152SPPW-55.P/O	—
75 ft	white	box	6152SPPW-75.P/O	—



15A Marine Grade Extension Cords

- Marine grade SJTOW cable
- Clear ends with lighted female end for visual power indication on 14/3 models
- Female end contains slide button lock for protection against cable disconnection*
- Slide button lock compatible with all other manufacturers' products*
- ETL certified to UL standards

Cable	Length	Description	Part #
14/3	25'	Locking and Lighted	150025
	50'	Locking and Lighted	150050
	25'	Lighted	150025NL
	50'	Lighted	150050NL
12/3	25'	Heavy-duty NEW	151225
	50'	Heavy-duty NEW	151250

*150025 and 150050 models only

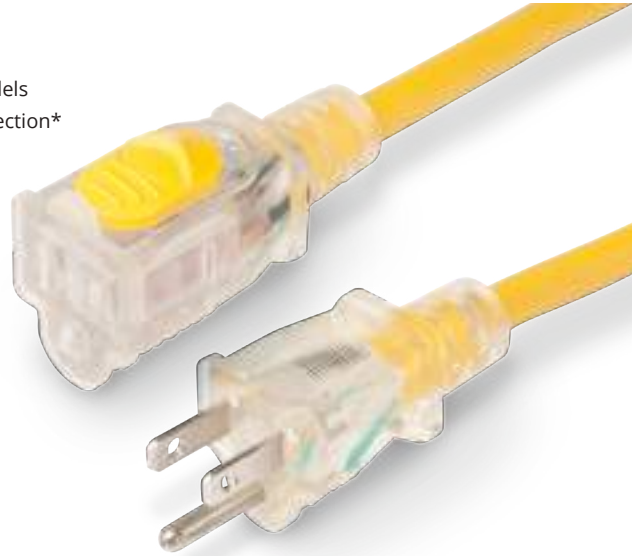

Cable
TV
Internet

Cable TV/Internet



HDTV / Internet Cable

- 50 ft yellow cable
- 75 ohm, 3G Hz RG6 Quad Shield cable with gasket sealed
- Weatherproof F-type connections on both ends

Part # **TVHD**



Combo TV/Phone Cordset

- Both cables are jacketed together
- Telephone and TV connections are molded on each end
- Features 18" of spliced cable at dock side for connections which are in separate power centers

Part # **PHTV6599** 50'



Telephone Cordset

- 3 conductor 16 AWG SJTO vinyl cord provides portable telephone connection for RV's and pleasure boats

Part # **PH6599** 50'



TV Cable Cordset

- Standard 75 ohm, RG59-U with quick, slip-on connections and heavy duty boots included on both ends

Part # **TV99-25** 25' yellow
Part # **TV99W** 50' white



Cable TV Outlet

- Spring-loaded lift cover
- Weatherproof closure
- Fits FS & FD boxes

Part # **TV97**
OEM # **TV97.OEM**



Telephone & Cable TV Outlet

- Spring-loaded lift cover
- Fits FS & FD boxes

Part # **PH6597TV**
OEM # **PH6597TV.OEM**

Cordset Accessories



Cord Clips

- Includes 6 cord clips with stainless steel mounting screws
- Keeps shore power cable out of the water
- Holds 10 gauge 30A cable
- Easy to install
- Use on deck or edge of dock
- Organize shore power cable

Part # CLIP

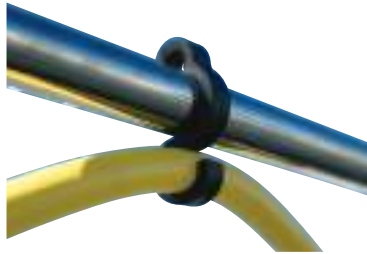

Railmount Cord Clips

- For 30A cords
- Organize shore power cords quickly and easily
- Can be used on tube or wire rails
- Packaged as set of 6 clips
- UV stable
- Practically unbreakable

Part # CLIP-01 black



Organizer Bag

- Heavy duty nylon zippered bag with handle
- Ideal for storing cordsets and adapters
- Dimensions 20" x 15" x 8"

Part # BAG

Cord Cover

- Keep shore power cables neat and bundled
- Holds 50A or 30A cordsets, can hold multiple cables
- UV resistant, machine washable marine grade fabric
- 24 ft

Part # CCVR-24 black



Carrying Strap

Bundle and organize your shore power cables or hoses with this durable and flexible nylon carrying strap. Its adjustable design fits around cordsets or hoses up to 9" in diameter while, the ergonomic, rubber handle makes carrying even larger 50 amp cord sets easy on your hand. A metal, reinforced grommet allows for hanging and storage.

Part # STRAP



Adapters

The Marinco® Shore Power Adapters give you more power hook-up flexibility and resolve a variety of dock side power center / boat side inlet power incompatibility problems.

TECH tip™

Choosing the Correct Adapter

Step 1: Boat Side – Identify your boat's Inlet Electrical System



The voltage and amperage should be printed on the outside cover of your existing boat inlet(s)



The voltage and amperage should be printed inside the boat Inlet(s) next to the blades

30A 125V



Check the blade orientation of the various inlets pictured and compare to your boat inlet(s)



Pay special attention to the differences in the 50A 125V and the 50A 125/250V. The blades look similar, but they are different. The plugs and receptacles for these systems are NOT interchangeable!!

50A 125V

50A 125/250V

Notice the additional grounding blade on the 50A 125/250V inlets.

IMPORTANT 50 AMP INFORMATION:

If you are connecting to 50A dock side power service, it is **CRITICAL** to know the dock side receptacle's voltage rating (50A 125V or 50A 125/250V). An adapter designed for 50A 125V will not plug into a dock side receptacle rated for 50A 125/250V service, and vice versa.

Step 2: Identify the Dock Side Power Source

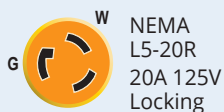

NEMA
L5-20R
20A 125V
Locking

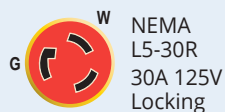

NEMA
L5-30R
30A 125V
Locking

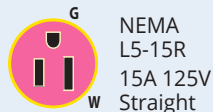

NEMA
L5-15R
15A 125V
Straight
Blade



NEMA
SS1-50R
50A 125V
Locking



NEMA
SS2-50R
50A 125/250V
Locking

Step 3: Choose a Marinco® Adapter from page 23-27

Match your boat side inlet(s) to the appropriate dock side receptacle or other power source. Adapter ends are color coded for easier selection.

Types of Adapters



Straight Adapters are high-quality, one-piece adapters similar in usage to Pigtail Adapters. However, they do not have sealing collars and are not recommended for use in wet locations. Use only in an enclosed, dry location, such as powering your boat from a 15A power receptacle inside your house.



Pigtail Adapters* allow you to connect from one dock side receptacle (or other power source receptacle) to one boat side inlet or equipment of dissimilar power configuration. These adapters are fully molded and equipped with Marinco®'s unique sealing collar (where indicated) and covers for use in wet locations.



"Y" Adapters* let you split one dock side receptacle between two boat inlets of similar or dissimilar power configurations. "Y" adapters are fully molded and equipped with Marinco®'s unique sealing collar and covers (where indicated) for use in wet locations.

The Reverse "Y" Adapter (Part # RY504-2-30) The reverse "Y" provides 50A 125/250V power when only two 30A 125V receptacles are available.

*Available with standard locking rings or with the new EEL quick locking system

Straight Adapters

Not recommended for use in wet locations.
Includes power LED.

Part #

S20-15
Replaces the 80A.



S30-15
Replaces the 81A.



S15-30
Replaces the 83A.



S20-30
Replaces the 84A.



S15-504



DOCK SIDE

MALE PLUG
Attaches to dock side receptacle or cordset



20A 125V
Locking



30A 125V
Locking

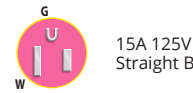

15A 125V
Straight Blade



20A 125V
Locking

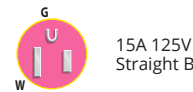

15A 125V
Straight Blade

BOAT SIDE

FEMALE CONNECTOR
Attaches to boat inlet or cordset



15 or 20A 125V
Straight Blade



15 or 20A 125V
Straight Blade



30A 125V
Locking



30A 125V
Locking

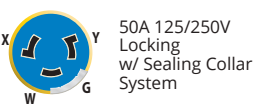

50A 125/250V
Locking
w/ Sealing Collar
System



EEL Pigtail Adapters

These adapters are equipped with sealing collars and are for use in wet locations.



Part #

P15-30

P15-30-25 25 ft

P15-30-25W 25 ft, white



P30-15



P30-503



P30-504



P503-30



P504-30



P504-503



DOCK SIDE

MALE PLUG

Attaches to dockside receptacle or cordset



15A 125V
Straight-Blade
w/ Locking
Screw



30A 125V
Locking



30A 125V
Locking



30A 125V
Locking



50A 125V
Locking



50A 125/250V
Locking



50A 125/250V
Locking

BOAT SIDE

FEMALE CONNECTOR

Attaches to boat inlet receptacle or cordset



30A 125V
Locking
w/ Sealing Collar
System



15A 125V
Straight Blade



50A 125V
Locking w/
Sealing Collar
System



50A 125/250V
Locking w/
Sealing Collar
System



30A 125V
Locking
w/ Sealing Collar
System



30A 125V
Locking
w/ Sealing Collar
System



50A 125V
Locking w/
Sealing Collar
System



Related Products



Sealing Rings
page 28-29

Pigtail Adapters

These adapters are equipped with covers and sealing collars (where indicated), and are for use in wet locations.

Part #

104SPP

LED Power-on indicator and thumbgrip locator

NEW 104SPPG gray

104SPP.OEM

104SPP-25.OEM 25 ft

104SPP-50.OEM 50 ft



LED Power-on indicator and thumbgrip locator

115A



LED Power-on indicator and thumbgrip locator

150SSP



106A



LED Power-on indicator and thumbgrip locator

NEW 105SPP gray

105SPPG



LED Power-on indicator and thumbgrip locator

111A



LED Power-on indicator and thumbgrip locator

117A



110A



LED Power-on indicator and thumbgrip locator

118A



121A



LED Power-on indicator and thumbgrip locator

123A



DOCK SIDE

MALE PLUG

Attaches to dockside receptacle or cordset



15A 125V Straight-Blade w/ Locking Screw



15A 125V Straight-Blade w/ Locking Screw



15A 125V Straight-Blade w/ Locking Screw



20A 125V Locking



30A 125V Locking



30A 125V Locking



30A 125V Locking



50A 125V Locking



50A 125V Locking



50A 125/250V Locking



50A 125/250V Locking

BOAT SIDE

FEMALE CONNECTOR

Attaches to boat inlet or cordset



30A 125V Locking w/ Sealing Collar System



50A 125V Locking w/ Sealing Collar System



50A 125/250V Locking w/ Sealing Collar System



30A 125V Locking w/ Sealing Collar System



15A 125V Straight Blade



50A 125V Locking w/ Sealing Collar System



50A 125/250V Locking w/ Sealing Collar System



30A 125V Locking w/ Sealing Collar System



50A 125/250V Locking w/ Sealing Collar System



30A 125V Locking w/ Sealing Collar System



50A 125V Locking w/ Sealing Collar System

EEL "Y" Adapters

These adapters are equipped with sealing collars and are for use in wet locations.

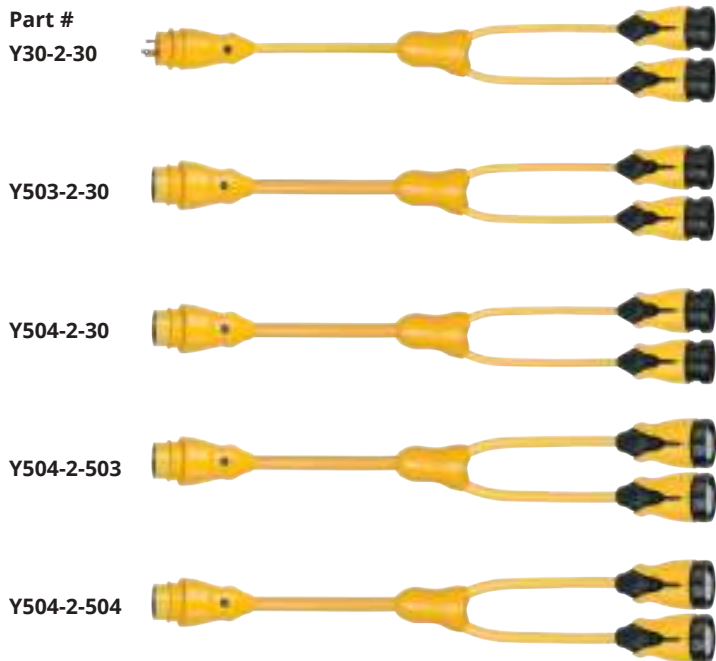

DOCK SIDE

MALE PLUG
Attaches to dock side receptacle or cordset

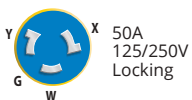

BOAT SIDE

FEMALE CONNECTOR
Attaches to boat inlet or cordset



"Y" Adapters

These adapters are equipped with covers and sealing collars (where indicated), and are for use in wet locations.



DOCK SIDE

MALE PLUG
Attaches to dock side receptacle or cordset

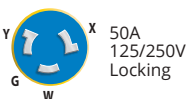
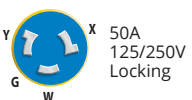
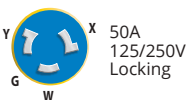

BOAT SIDE

FEMALE CONNECTOR
Attaches to boat inlet or cordset



Reverse "Y" Adapter

The Reverse "Y" Adapter has two male plugs with special power isolation circuitry for added safety. When one plug is connected to a receptacle, the circuitry isolates the second plug. The reverse "Y" provides 50A 125/250V power when only two 30A 125V receptacles are available.

Note: Reverse "Y" will NOT work with 50A, 125V, 3-wire inlets. Power is provided in both circuits to the 4-wire inlet, but the dock side receptacles limit the current in each circuit to 30A. The two 30A 125V receptacles must be supplied from a single power source providing 208V to 250V between them for proper operation.

Part #
RY504-2-30



DOCK SIDE

MALE PLUG
Attaches to dock side receptacle or cordset



BOAT SIDE

FEMALE CONNECTOR
Attaches to boat inlet or cordset



Right Angle Adapters

Part #
1RPC
(30 amp)



1RPC50
(50 amp)



DOCK SIDE

MALE PLUG
Attaches to dock side receptacle or cordset



BOAT SIDE

FEMALE CONNECTOR
Attaches to boat inlet or cordset

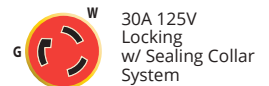

Dock Side 30A to 15A Adapter with GFCI

Part #
199128



DOCK SIDE

MALE PLUG
Attaches to dock side receptacle or cordset



BOAT SIDE

FEMALE CONNECTOR
Attaches to boat inlet or cordset

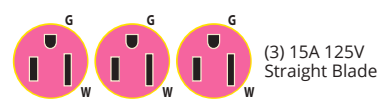

- Provides safer hook-up to 30A dock side power
- Provides protection against harmful electric shock
- Reduces the possibility of fire
- Offers protection for up to 3 attached tools
- Corrosion resistant and rain-proof rated for outdoor use
- GFI trip level of 4-6 mA
- Can also be used for other outdoor, harsh environments such as construction sites or wherever ground fault protection is desired

Note: A Ground Fault Circuit Interrupter (GFCI) limits the duration of an electrical shock to a period considered safe for healthy people. It does not prevent electric shock. This device does not protect against electric shock due to contact with both circuit conductors or a fault in any wiring supplying this device.

Related Products



Sealing Rings
page 28-29

TECH tip

GFCI Protection

According to ABYC standard E-11.11. A Ground Fault Circuit Interrupter (GFCI) may be used on single phase AC circuits to provide additional protection for personnel and equipment.

30A
125V**30 Amp 125V Devices & Accessories****Male Plug**

Part # 305CRPN
OEM # 305CRPN.OEM

**Female Connector**

Part # 305CRCN
OEM # 305CRCN.OEM

**Male Plug & Cover**

- Weather resistant cover

Part # 305CRPN.VPK

**Female Connector w/ Cover**

- Weather resistant cover

Part # 305CRCN.VPK

**Locking Receptacle**

- Corrosion resistant
- Reinforced nylon construction
- Yellow

Part # 305CRR

**Locking Receptacle**

- Corrosion resistant
- Reinforced nylon construction
- Black

Part # 305CRRB
OEM # 305CRRB.OEM

**Weatherproof Cover w/ Threaded Sealing Ring**

- Use with 305CRCN or 205CRCN

Part # 103RN
OEM # 103RN.OEM

**Weatherproof Cover w/ Easy Lock™ Sealing Ring**

- Use with 305CRCN or 205CRCN

Part # 103ELN

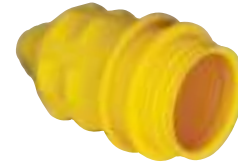
**Weatherproof Cover**

- Use with 305CRPN or 205CRPN

Part # 102N

**Easy Lock™ Sealing Ring**

- Use with 30 amp Marinco® Inlets

Part # 100EL

**Threaded Sealing Ring**

- Use with 30 amp systems

Part # 100R

**Sealing Collar w/ Threaded Ring**

- Provides maximum moisture protection between cordset & adapter
- Use with 20 & 30 amp locking systems

Part # 110R

50A
125V **50 Amp 125V Devices & Accessories**



Male Plug

- 2 pole, 3 wire

Part # 6361CRN



Female Connector

- 2 pole, 3 wire

Part # 6360CRN
OEM # 6360CRN.OEM



Wire Dock Side Receptacle

- 2 pole, 3 wire

Part # 6370CR

50A
125/250V **50 Amp 125/250V Devices & Accessories**



Male Plug

- 3 pole, 4 wire

Part # 6365CRN
OEM # 6365CRN.OEM



Female Connector

- 3 pole, 4 wire

Part # 6364CRN
OEM # 6364CRN.OEM



Wire Dock Side Receptacle

- 3 pole, 4 wire

Part # 6369CR
OEM # 6369CR.OEM



**Weatherproof Cover w/
Threaded Sealing Ring**

- Use with 6360CRN or 6364CRN

Part # 7715CRN
OEM # 7715CRN.OEM



**Weatherproof Cover w/
Easy Lock™ Sealing Ring**

- Use with 6360CRN or 6364CRN

Part # 7715ELN
OEM # 7715ELN.OEM



Weatherproof Cover

- Use with 6361CRN or 6365CRN
- Can be used on both male & female ends

Part # 7717N yellow
OEM # 7717N.OEM yellow
Part # 102182 white



Easy Lock™ Sealing Ring

- Use with 50 amp Marinco® Inlets

Part # 500EL



**Threaded Locking
Sealing Ring**

- Use with 50 amp systems

Part # 500R



**Sealing Collar w/
Threaded Ring**

- Provides maximum moisture protection between cordset & adapter
- Use with 50 amp only systems

Part # 510R

15A
125V**15 Amp 125V Devices & Accessories****Male Plug**

- Straight blade

Part # 5266CR

**Female Connector**

- Straight blade

Part # 5269CR

**Male Plug**

- Locking type

Part # 4721CR

**Female Connector**

- Locking type

Part # 4731CR

**Duplex Locking Receptacle**

- Yellow

Part # 4700CR

**Duplex Straight Receptacle**

Part # 5262CRR yellow
Part # 5262CRR.GRY gray

20A
125V**20 Amp 125V Devices & Accessories****Male Plug**

- Straight blade

Part # 5366CR

**Female Connector**

- Straight blade

Part # 5369CR
OEM # 5369CR.OEM

**Male Plug**

- Locking type
- Uses weatherproof cover 102N

Part # 205CRPN

**Female Connector**

- Locking type
- Uses weatherproof cover 103RN

Part # 205CRCN

**Locking Receptacle**

Part # 205CRR

15 & 20 Amp Devices & Accessories



Weatherproof Cover

- Use with 5366CR or 5266CR plugs

Part # 6017



Weatherproof Cover

- Use with 5369CR or 5269CR connectors

Part # 6018



Weatherproof Cover

- Can be used on 15 & 20 amp

OEM # 1520BI.OEM



Universal Watertight Connector Cap

- For use on 16 or 32 amp products for CE compliance
- For use on 30 or 50 amp products to protect the connector when not in use

Part # 199111PK 16A/30A/32A/50A/63A



Watertight Connector Cap

- For use on 16 or 32 amp products for CE compliance
- For use on 30 or 50 amp products to protect the connector when not in use

Part # 199109PK 16A/30A

Part # 199110PK 32A/50A



Ground Fault Circuit Interrupter (GFCI)

CAUTION: Ground Fault Circuit Interrupter protection is required when using electrical products outdoors or near water. GFCI Protection is required by the ABYC where a receptacle is in a head, galley, machinery space or weather deck.

Part # 1591-FI ivory

Part # 1591-FI.WHITE white

OEM # 1591-FI.GRY.OEM gray



Boxes / Covers / Replacement Parts



FS Box

- Black non-metallic, with two 3/4" K.O. holes
- Accepts 15A, 20A and 30A receptacles, and 7420CR weatherproof covers

Part # 6080



FD Box with 3/4" or 1" K.O. Holes

- Yellow fiberglass, with two K.O. holes
- Accepts 15A, 20A, 30A & 50A receptacles, and 7420CR & 7788CR covers

Part # 6083CR 3/4" holes

Part # 6084CR 1" holes



Weatherproof Cover

- Yellow LEXAN® polycarbonate with lift lid
- Fits 15A, 20A, & 30A single receptacles

Part # 7420CR

OEM # 7420CR.OEM



Weatherproof Cover

- Yellow LEXAN® polycarbonate with lift lid
- Fits 50A receptacles 6369CR & 6370CR

Part # 7788CR



Plastic Switch/Outlet Box

- 3-9/32" x 2-3/16" x 2-1/2" D
- Can be secured against the back of wall or wall facing
- Accepts 15A, 20A & 30A receptacles, telephone outlets and TV coax connectors

Part # 6079



302 Stainless Steel Sealed Cover with Lift Lid

- Fits 4700CR, 5262CRR, & 5739CR duplex receptacles

Part # 7879CR



302 Stainless Steel Sealed Cover with Lift Lid

- Fits GFCI duplex receptacles

Part # 7879CR-FI

OEM # 7879CR-FI.OEM



Replacement Interior

- Fits 50A 125/250V Easy Lock 4-wire stainless steel or standard inlets manufactured after 8-1-93

Part # 6373ELMB



Replacement Interior

- Fits 303SSEL-B, 303SSI-B & 301EL-B boat inlets

Part # 305CRMB



Replacement Interior

- Fits 30A standard non-metallic inlets manufactured prior to 1/1/91

Part # 301CRMB



Replacement Boss Ring

- For use on 30A or 50A stainless steel inlets

Part # 102167 30A

Part # 102164 50A



Warning Labels

- For use on standard inlets
- For warning label placement use per ABYC standard 11.6.2.2.3

Part # 101739

International Shore Power 16 Amp 230V, 50Hz Locking

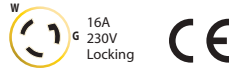

Stainless Steel Inlet

- 316 stainless steel
- Easy Lock™ system
- Soft touch cap design
- Rear safety enclosure with strain relief
- IP56 rated

Part # 303SSEL-BXPK
OEM # 303SSEL-BX



Standard Inlet

- Easy Lock™ system
- Glass-filled polyester
- Watertight
- Rear safety enclosure with strain relief
- IP56 rated

Part # 301EL-BXPK
OEM # 301EL-BX



Contour Inlet

- Easy Lock™ system
- Glass-filled polyester
- Watertight
- Rear safety enclosure with strain relief
- IP56 rated

OEM # 304EL-BX.NT
OEM # 304EL-BX stainless steel trim



Female Connector

- Corrosion resistant contacts and terminals
- Use with cover 103RNX and cap 199109

Part # 305CRCXNPK
OEM # 305CRCXN



Weatherproof Cover w/ Threaded Ring

- Use with 305CRCXN

Part # 103RNXPK
OEM # 103RNX



Connector Kit

- Includes female connector, weatherproof cover with threaded ring and watertight cap

Part # 199114



Locking Shore Power Cordset

- H07BQ-F 3G 2.50 mm² harmonized cable
- IEC 60309 plug 2P+E [6H], 250V/50Hz
- Watertight connector sealing cap for CE compliance
- NEMA L5-30 moulded connector with LED power indicator light

Part # 25MSPPXP 25 meters
Part # 20MSPPXP 20 meters
Part # 15MSPPXP 15 meters
Part # 10MSPPXP 10 meters
Part # 1MSPPXP 1 meters



Harmonized Cable Cordset

- Blunt cut
- H07BQ-F 3G 2.50 mm² harmonized cable
- Watertight connector sealing cap for CE compliance
- NEMA L5-30 moulded connector with LED power indicator light

Part # 25MSPPX 25 meters
Part # 20MSPPX 20 meters
Part # 15MSPPX 15 meters
Part # 10MSPPX 10 meters
Part # 1MSPPX 1 meters



12/3 Cable Cordset

- Blunt cut
- 12/3 (3.3 mm²) cable 16A/220V 50Hz
- Watertight connector sealing cap for CE compliance
- NEMA L5-30 moulded connector with LED power indicator light

Part # 50SPPX 50 ft
Part # 25SPPX 25 ft

International Shore Power 32 Amp 230V, 50Hz Locking

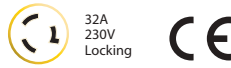

Stainless Steel Inlet

- 316 stainless steel
- Easy Lock™ system
- Soft Touch cap design
- Rear safety enclosure with strain relief
- No rear safety enclosure
- IP56 rated

Part # 6371EL-BX
OEM # 6371ELX



Standard Inlet

- Easy Lock™ system
- Glass-filled polyester
- Watertight
- Rear safety enclosure with strain relief
- IP56 rated

OEM # 6351EL-BX



Contour Inlet

- Easy Lock™ system
- Glass-filled polyester
- Watertight
- Rear safety enclosure with strain relief
- IP56 rated

OEM # 6343EL-BX



Female Connector

- Corrosion resistant contacts and terminals
- Use with cover 7715CRN and sealing cap 199110

Part # 6360CRNXPK
OEM # 6360CRNX



Weatherproof Cover w/ Threaded Ring

- Use with 6360CRNX, 6401CRCX, 6401CRPX, 6402CRCX, or 6402CRPX

Part # 7715CRNXPK
OEM # 7715CRNX



Connector Kit

- Includes female connector, weatherproof cover with treaded ring and watertight cap

Part # 199115



Locking Shore Power Cordset

- H07BQ-F 3G 4 mm² harmonized cable
- IEC 60309 plug 2P+E [6H], 250V/50Hz
- Watertight connector sealing cap for CE compliance
- NEMA SS-1 moulded connector with LED power indicator light

Part # 15M32AXP 15 meters
Part # 1M32AXP 1 meter



Harmonized Cable Cordset

- Blunt cut
- H07BQ-F 3G 4 mm² harmonized cable
- Watertight connector sealing cap for CE compliance
- NEMA SS-1 moulded connector with LED power indicator light

Part # 15M32AX 15 meters



8/3 Cable Cordset

- Male end blunt cut
- 8/3 (8.6 mm²) cable
- Moulded connector with LED power indicator light

Part # 6153SPPX 50 ft

International Shore Power 63 Amp 230V, 50Hz Locking Single Phase, 3 Wire

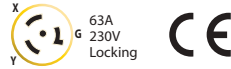

Stainless Steel Inlet

- 316 stainless steel
- Easy Lock™ System
- Soft touch cap design
- Rear safety enclosure with strain relief
- IP56 rated

Part # 6401EL-BX



Female Connector

- Corrosion resistant contacts and terminals

Part # 6401CRCX



Male Connector

- Corrosion resistant contacts and terminals

Part # 6401CRPX

63 Amp 230V, 50Hz Locking Three Phase, 4 Wire

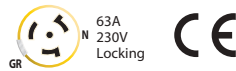

Stainless Steel Inlet

- 316 Stainless steel
- Easy Lock™ system
- Soft touch cap design
- Rear safety enclosure with strain relief
- IP56 rated

Part # 6402EL-BX



Female Connector

- Corrosion resistant contacts and terminals

Part # 6402CRCX



Male Connector

- Corrosion resistant contacts and terminals

Part # 6402CRPX



Weatherproof Cover w/ Threaded Ring

- Use with 6360CRNX, 6401CRCX, 6401CRPX, 6402CRCX, or 6402CRPX

Part # 7715CRNXPK

OEM # 7715CRNX

100 Amp 125/250V 3 Pole 4-Wire



Cordsets **NEW**

All Marinco® cordsets are made of the highest quality, marine grade construction with features you won't find on other power cords.

- For use with 100 amp 125/250 volt shore power systems
- High visibility, 2 AWG, flexible yellow STOW cable is oil, water, UV resistant, and rated to 105°C
- IEC pin & sleeve plugs and connectors are designed for harsh environments, watertight, and corrosion resistant. Feature integrated locking rings.
- Options for use with on-board isolation transformers, male plug only power supply, and extension purposes
- UL and ABYC approved

Length	Neutral Wire	Female End	Application	Color	Part #
75'	no	yes	Isolation transformer cordset	yellow	CS75IT4
75'	yes	yes	Standard cordset	yellow	CS754
75'	yes	no, blunt cut	Cable winch	yellow	CW754
100'	no	yes	Isolation transformer cordset	yellow	CS100IT4
100'	no	no, blunt cut	Cable winch w/ isolation transformer	yellow	CW100IT4
100'	yes	no, blunt cut	Cable winch	yellow	CW1004
125'	no	no, blunt cut	Cable winch w/ isolation transformer	yellow	CW125IT4
Extension Cord					
50'	yes	yes	Extension cable	yellow	CS50EXT4*

*CS50EXT4 extension cord has connector body M4100C12 shown below.



RESISTANT

5 YEAR WARRANTY



Plug w/ Gasketed Locking Ring

- Mate with M4100R12 receptacle

Part # M4100P12



Connector Body

- Mate with plug on extension cords or adapters. Note: It does not mate with shore power inlet.

Part # M4100C12



Connector Body w/ Gasketed Locking Ring

- Mate with M4100B12R inlet

Part # M4100C12R

Dock Side Receptacle

- Spring loaded cover providing a IP67 watertight rating when tightened

Part # M4100R12



Shore Power Inlet

- Spring loaded cover providing a IP67 watertight rating when tightened

Part # M4100B12R



100 Amp 3ØY 120V/208V 4 Pole 5-Wire



Cordsets **NEW**

All Marinco® cordsets are made of the highest quality, marine grade construction with features you won't find on other power cords.

- For use with 100 amp 120/208 volt shore power systems
- High visibility, 2 AWG, flexible yellow STOW cable is oil, water, UV resistant, and rated to 105°C
- IEC pin & sleeve plugs and connectors are designed for harsh environments, watertight, and corrosion resistant. Feature integrated locking rings.
- Options for use with on-board isolation transformers and male plug only power supply purposes
- UL and ABYC approved



Length	Neutral Wire	Female End	Application	Color	Part #
75'	No	yes	Isolation transformer cordset	yellow	CS75IT5
100'	No	yes	Isolation transformer cordset	yellow	CS100IT5
100'	No	no, blunt cut	Cable winch w/ isolation transformer	yellow	CW100IT5
125'	No	no, blunt cut	Cable winch w/ isolation transformer	yellow	CW125IT5



5 YEAR WARRANTY



Plug w/ Gasketed Locking Ring

- Mate with M5100R9 receptacle

Part # M5100P9



Connector Body

- Mate with plug on extension cords or adapters. Note: It does not mate with shore power inlet.

Part # M5100C9

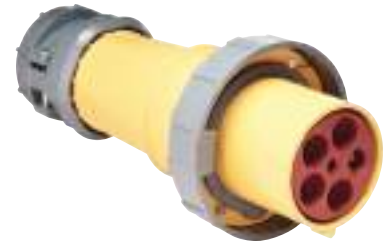

Connector Body w/ Gasketed Locking Ring

- Mate with M5100B9R inlet

Part # M5100C9R

Dock Side Receptacle

- Spring loaded cover providing a IP67 watertight rating when tightened

Part # M5100R9



Shore Power Inlet

- Spring loaded cover providing a IP67 watertight rating when tightened

Part # M5100B9R



DC POWER CONNECTIONS

12V Receptacles & Plugs

40



Marinco offers a wide selection of high quality DC electrical products that are designed specifically for harsh marine environments.

12V Dual USB Receptacles

41



A wide range of USB receptacles for charging mobile device, tablets, and other accessories.

12V Receptacles & Plug Accessories

42



Mounting brackets, plates, extension cords, and other essential accessories for managing your 12 V receptacles and plugs.

DC POWER CONNECTIONS

Charging / Trolling / Downrigger System



43
Marinco offers a complete line of plugs and receptacles designed exclusively for trolling motors and downriggers. Including the 70 Amp trolling motor plug.

Battery Direct Connect

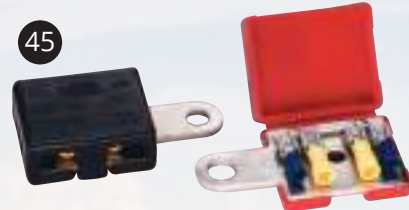

45
Terminate up to 4 electronic instruments on each set of battery terminals.



Charging today's mobile devices on the go is a necessity and requires products built to withstand the marine environment.



The importance of a quality DC electrical system

There's an old axiom that states, "The strongest chain is only as reliable as its weakest link," and the same analogy can be applied to your boat's DC electrical system. Put it in a harsh salt water or fresh water environment, where a vessel's wiring and components are subjected to more concentrated abuse in one season than your family car would experience in five years, and it's easy to realize that small electrical problems can get out of hand very quickly.

Safety onboard starts with a reliable DC electrical system that is installed and designed with the proper high quality wiring, components and connections to fulfill all of your intended DC tasks. If you're tempted to take shortcuts when wiring your boat, don't, as these types of cost-cutting measures can come back to bite you at the worst possible moments, potentially compromising the safety of your boat and crew.

So, whether you ply fresh water lakes, back bays, coastal areas or make long distance blue water runs to the edge of the continental shelf, Marinco® offers a wide selection of high quality, low voltage DC electrical products designed specifically for the harsh marine environment.

Now you can spend more time enjoying your boating experience and less time dealing with unwanted electrical hassles.

SeaLink® 12 Volt

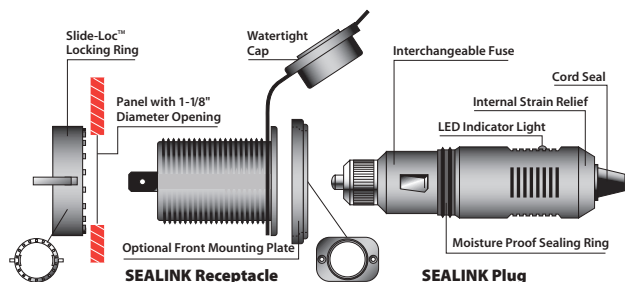

The SeaLink® 12 volt family of products are manufactured from corrosion resistant marine grade materials. Exclusive to SeaLink® products is a unique interconnecting system that securely locks the plug into the receptacle resulting in a positive and moisture-proof connection. The plug and receptacle feature optimized metal connection points for maximum conductivity.

ConnectPro® Charging & Trolling

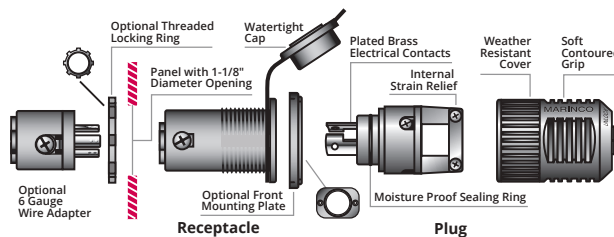

The ConnectPro® trolling motor plug and receptacle is a revolutionary concept in trolling motor DC connections. The ConnectPro® system has superior electric current carrying capacity that eliminates problems that rob motors of power and reduce battery life. The ConnectPro® system features a locking plug and receptacle and spring clamping connection, which provides a secure electrical contact.

12V Receptacles / Plugs / Accessories



12 Volt Receptacle with Protective Cap

- Stainless Steel
- Includes stainless steel mounting plate and wire set
- Max rating is 20 amps

Part # 20036



SeaLink® Deluxe 12 Volt Receptacle w/ Old Style Ring

- Watertight sealing cap
- Easy to install with locking ring for rear access installation
- Compatible with standard 12V plugs
- Max rating is 20 amps

OEM # 12VRCO

OEM # 12VRCO.PG w/gasket

OEM # 12VRCY sealed seams

12V Receptacles / Plugs / Accessories



12VRC



12VRCW



12VRC.OEM



12VRCW.OEM

SeaLink® Deluxe 12 Volt Receptacle

- Watertight sealing cap
- Easy to install, with supplied mounting plate for front panel installation, or locking ring for rear access installation
- Compatible with standard 12V plugs
- Max rating is 15 amps

Part # 12VRC black
 Part # 12VRC.PG black w/gasket
 Part # 12VRCW white

SeaLink® Deluxe 12 Volt Receptacle

- Watertight sealing cap
- Easy to install with locking ring for rear access installation
- Compatible with standard 12V plugs
- No mounting plate
- Max rating is 15 amps

OEM # 12VRC.OEM black
 OEM # 12VRCW.OEM white



SeaLink® Deluxe 12 Volt Plug

- Moisture proof sealing ring
- LED power indicator light
- Interchangeable 10A fuse
- Internal strain relief and cord seal
- Compatible with standard 12V receptacles
- Max rating is 10 amps

Part # 12VPG
 OEM # 12VPG.OEM



SeaLink® Deluxe 12 Volt Receptacle & Plug

- 12VRC and 12VPG packaged together

Part # 12VPK



12VDUSB

12VDUSBW-B

SeaLink® Deluxe Dual USB Charger Receptacle

- 12V to 24V DC input
- 5V, 2.1 amp total output
- LED power indicator light for USB
- Water resistant cover protects against dust and water

Part # 12VDUSB black (with insulated terminals)
 OEM # 12VDUSB-B black
 OEM # 12VDUSBN-B black no LED
 OEM # 12VDUSBW-B white



12VCOMBO

12VCOMBOW-B

SeaLink® Deluxe Dual USB Charger & 12V Receptacle

- 12V DC input
- Dual USB has 5V, 2.1 amp total output
- LED power indicator light for USB
- Receptacle has 12V DC output, rated up to 20 amps
- Water resistant covers protects against dust and water

Part # 12VCOMBO black (with insulated terminals)
 OEM # 12VCOMBO-B black
 OEM # 12VCOMBON-B black no LED
 OEM # 12VCOMBOW-B white

12V Receptacles / Plugs / Accessories



12MP.OEM

300259

SeaLink® Mounting Plate

- Easy to install or retrofit
- 12MP.OEM use with 12VRCY, 12VRC.OEM, 12VRCO, or 12VBR.OEM
- 300259 use with 12VRCW.OEM

OEM # 12MP.OEM black
OEM # 300259 white



SeaLink® Receptacle Mounting Bracket

- Bracket for under dash mounting of the SeaLink® or ConnectPro® receptacles
- Receptacle installs with rear mounting threaded nut
- Marine grade anodized aluminum
- Dimensions: 2" W x 2-1/2" H

Part # 12BKT



Boot

- For use with 12V products
- Creates a weatherproof seal

Part # 300275



Trolling Motor Adapter Terminal

- 6 gauge

Part # 12VPL.OEM



SeaLink® Deluxe 12V Extension Cord

- Heavy duty 18 gauge wire, extends to over 6 feet
- Watertight cap
- Plug features an LED indicator light, moisture proof sealing ring, strain relief and built-in 10A fuse
- SeaLink® locking system
- Works with any standard 12V plug and receptacle

Part # 12VXT



USB Port

- 6 ft
- USB extension cable with weatherproof cap

Part # USBA6
OEM # USBA6.OEM



SeaLink® Deluxe 12V Dual Outlet Cord

- Heavy duty 18 gauge wire, extends to over 1 foot
- Watertight caps
- Plug features an LED indicator light, moisture proof sealing ring, strain relief and built-in 10A fuse
- SeaLink® locking system
- Works with any standard 12V plug and receptacle

Part # 12VAD

3-Wire 70A Charging / Trolling System



70A Trolling Motor Receptacle

- 70A continuous rating
- Universal design for 2 or 3-wire configuration 12V, 24V, 12/24V, 24/36V, 36V or 48V systems
- Floating pin design for maximum connectivity and durability
- Corrosion resistant, plated brass electrical components
- Watertight sealing cap
- Accepts 8 and 6 AWG wire

Part # 12VBR53
OEM # 12VBR53.OEM



70A Trolling Motor Plug

- 70A continuous rating
- Universal design for 2 or 3-wire configuration 12V, 24V, 12/24V, 24/36V, 36V or 48V systems
- Floating pin design for maximum connectivity and durability
- Corrosion resistant, plated brass electrical components
- Integrated strain relief
- Keyed design with thumbprint locator
- Accepts 8 and 6 AWG wire

Part # 12VBPS3
OEM # 12VBPS3.OEM



70A Trolling Motor Plug & Receptacle

- 70A continuous rating
- Universal design for 2 or 3-wire configuration 12V, 24V, 12/24V, 24/36V, 36V or 48V systems
- Floating pin design for maximum connectivity and durability
- Corrosion resistant, plated brass electrical components
- Receptacle contains watertight sealing cap
- Plug contains Integrated strain relief and keyed design with thumbprint locator
- Accepts 8 and 6 AWG wire

Part # 12VCPS3

3-Wire ConnectPro® Charging / Trolling System



PATENTED

ConnectPro® Receptacle

- Universal design for 2 or 3-wire configuration 12V, 24V, 12/24V, 24/36V or 36V systems
- Watertight sealing cap
- Corrosion resistant, plated brass electrical components
- Drain holes in receptacle keep water away from electrical components
- Perma-Lock™ screw terminals will not loosen under extreme hull vibration
- Standard 1-1/8" diameter mounting hole
- Easy to install, with supplied mounting plate for front panel installation, or locking ring for rear access installation
- Accepts 10 and 8 AWG wire
- Easily replaces other trolling motor plugs and receptacles
- Max rating is 40 amps

Part # 12VBR with mounting plate
OEM # 12VBR.OEM without mounting plate



ConnectPro® Plug

- O-ring seal for waterproof connections
- Weather resistant plug cover
- Corrosion resistant, plated brass electrical components
- Accepts 16 to 8 AWG wire
- Ergonomic contoured grip for easy hook-up and ground blade alignment
- Max rating is 40 amps

Part # 12VBP
OEM # 12VBP.OEM



ConnectPro® Receptacle & Plug

- 12VBR and 12VBP packaged together

Part # 12VCP



6 Gauge ConnectPro® Wire Receptacle Adapter

- Allows 6 AWG wire connection to ConnectPro® receptacle
- Corrosion resistant, plated brass electrical components

Part # 12VBRAD
OEM # 12VBRAD.OEM



ConnectPro® Receptacle, Plug & 6 Gauge Adapter

- 12VBR and 12VBP and 12 VBRAD packaged together
- Max rating is 40 amps

Part # 12VCP6

2-Wire ConnectPro® Charging / Trolling System / Downrigger



ConnectPro® Receptacle

- Works with 12V, 24V, or 36V 2-wire systems
- For front mount panel installations
- Weather resistant sealing cap
- Drain holes in receptacle keep water away from electrical components
- Perma-Lock™ screw terminals will not loosen under extreme hull vibration
- Fits standard 1-1/8" diameter mounting hole
- Accepts up to 10 AWG wire

Part # 12VBR52

OEM # 12VBR52.OEM



ConnectPro® Plug

- O-ring seal for waterproof connections
- Weather resistant plug cover
- Corrosion resistant, plated brass electrical components
- Accepts 16 to 8 AWG wire
- Ergonomic contoured grip for easy hook-up and ground blade alignment
- Max rating is 40 amps

Part # 12VBPS2

OEM # 12VBPS2.OEM



ConnectPro® Receptacle & Plug

- 12VBR52 and 12VBPS2 packaged together

Part # 12VCPS2

3-Wire 30 Amp 125V Locking Charging / Trolling System



Male Plug

- Short housing, black nylon with internal strain relief system and recessed fasteners

Part # 305BP

OEM # 305BP.OEM



Female Connector

- Short housing, black nylon with internal strain relief system and recessed fasteners

Part # 305BC



Receptacle

- Corrosion resistant reinforced nylon.
- Accepts 8 AWG stranded wire or up to 6 AWG with spade terminals

Part # 305CRRB

OEM # 305CRRB.OEM



4-Wire 12/24V Locking Charging / Trolling System

The 4-wire Trolling/Charging System eliminates the need for a charge/run switch. Install the receptacle on the boat, mount the black trolling motor plug on the trolling motor, and the red charger plug on the leads of the battery charger. Simply plug in the black plug to troll, or plug in the red plug to charge.



Charger Plug (Male)

- Accepts up to 10 AWG wire
- Red

Part # 2018BP-12



Trolling Motor Plug (Male)

- Connects to trolling motor
- Jumpered internally to supply 12V & 24V power to the trolling motor when plugged into the receptacle
- Accepts up to 8 AWG wire
- Max rating is 60 amps
- Black

Part # 2018BP-24
OEM # 2018BP-24.OEM



Receptacle & Bracket

- Spring loaded flip lid cover and 2018BR receptacle, pre-assembled

Part # 2018BR-MB



Bracket

- Spring loaded flip lid cover, without receptacle

Part # 2018MB
OEM # 2018MB.OEM



Trolling-Charging System Package

- Includes the 2018BP-12, 2018BP-24, and 2018BR-MB

Part # 2018PKG



Receptacle

- Glass-reinforced corrosion resistant nylon. Accepts 8 AWG stranded wire or up to 6 AWG with spade terminals.

Part # 2018BR
OEM # 2018BR.OEM
OEM # 2018BR.OEM.BPS (case pack)

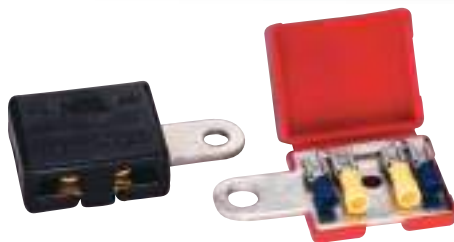

Battery Direct Connect™ Multi Connection Battery Terminals

- Terminate up to four electronic instruments on each set of terminals
- Comes complete with quick-connect terminals
- Positive molded in red, negative molded in black
- All one-piece, no screws or parts to lose
- Cover snaps tight when closed
- Meets ABYC standard E-10.8

Part # 12VTR
OEM # 12VTR.OEM



Battery Direct Connect™ Details

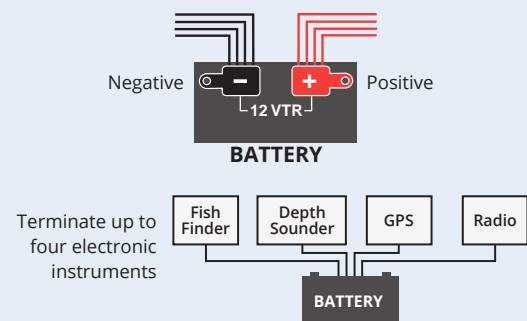

POWER CONVERSION

Guest ChargePro™ On-Board Battery Chargers

48



New line of Guest chargers ranging from 5 to 40 amps, with fully automatic 5-Stage performance charging for 12 volt lead acid and AGM batteries. Chargers have dedicated outputs, aluminum housings and expanded LED charge status. 100% waterproof and shock resistant for all fresh and salt water applications.

1.5 Amp ChargePro™ Maintainer

50



Keep your battery charged with this highly reliable, Guest 1.5 Amp maintainer. Extends battery life and will charge, monitor and re-charge your battery if the voltage drops below 12.9V. The maintainer can be safely connected to the battery for short or long periods of time.



POWER CONVERSION

GUEST Portable Battery Chargers

51



Take the charger to the battery with the Guest portable charger. Charges and maintains a full charge without the fear of overcharging or boiling electrolytes.

Battery Charger Inlets

51



Front mount and rear mount inlets are compatible with the ConnectCharge Plug. Eliminates rewiring the inlets and saves time and money.



CHARGEPRO™

Guest On-Board Battery Chargers **NEW**

For 12, 24, 36 and 48 volt systems (model specific)

Guest On-Board battery chargers have been redesigned from the inside out with the customer in mind. Our newest generation On-Board Marine battery chargers include leading advancements in digital charging technology and waterproof design/construction. Designed to maximize individual battery performance, extend battery life and show battery status better than ever before.

Every Guest charger has a dedicated output that delivers the full amount of amps per bank. The easy to read graphics indicates the status of each battery bank through the charging process.

ChargePro's low profile flangeless extruded aluminum housing is sealed by gaskets with heavy duty end caps for 100% waterproof performance to IP67. This new construction design delivers an increase in charging and thermal management performance. The new ChargePro Series is up to 40% lighter while increasing durability and ease of installation over prior generations of older technology epoxy filled plastic body chargers.

- All high frequency, digital charging technology
- Microprocessor and software control for precision, fully automatic 5-stage performance charging
- Fully automatic 5-stage performance charging
- Dedicated battery charging, sensing and control per bank
- Individual battery sensing and control
- Expanded LED charge status monitor
- Wiring and battery fault detection
- Auto-maintain energy saver mode
- Up to 40% lighter
- 100% Waterproof (IP67) and shock resistant for all fresh and saltwater applications
- All models are pre-wired for easy installation
- For all 12 volt flooded and AGM lead acid batteries
- Built-in safety: reverse polarity, over-current, over-voltage, over-temperature and ignition protection. In-line fuses for maximum DC wire protection.
- 2 year warranty



2713A



2711A



2708A



Expanded LED display



Battery fault detection LEDs



Heavy-Duty strain reliefs



In-line safety fuses



NEMA 5-15P plug



Certified to:
UL STD 1236
CSA C22.2 No. 107.2
FCC Class B

IP67



Designed and
Constructed to: **ABYC**
ABYC-31 Setting Standards for Safer Boating

Guest ChargePro™ Series Selection ChargePro 5A to 20A Models



Model	ChargePro 5	ChargePro 4/4	ChargePro 10	ChargePro 5/5	ChargePro 5/5/5	ChargePro 10/10
Part #	2708A	2707A	2710A	2711A	2713A	2720A
Input Volts	90-135V AC 50/60Hz	90-135V AC 50/60Hz	90-135V AC 50/60Hz	90-135V AC 50/60Hz	90-135V AC 50/60Hz	90-135V AC 50/60Hz
DC System Voltage	12	12/24	12	12/24	12/24/36	12/24
Banks	1	2	1	2	3	2
Amps	5	4/4	10	5/5	5/5/5	10/10
Amps Per Bank	5	4	10	5	5	10
AC Cord Length	6'	6'	6'	6'	6'	6'
Size (W x H x L)	7.5" x 2.4" x 7.2"	7.5" x 2.4" x 9.0"	7.5" x 2.4" x 9.0"	7.5" x 2.4" x 9.0"	7.5" x 2.4" x 12.9"	7.5" x 2.4" x 12.9"
Weight (lbs)	3.2	4.5	4.2	4.7	6.7	6.6

ChargePro 30A and 40A Models

Designed for demanding 12, 24, 36 and 48 volt battery systems requiring 10 amps per battery for the fastest charge times.



Model	ChargePro 10/10/10	ChargePro 10/10/10/10
Part #	2731A	2740A
Input Volts	90-135V AC 50/60Hz	90-135V AC 50/60Hz
DC System Voltage	12/24/36	12/24/36/48
Banks	3	4
Amps	10/10/10	10/10/10/10
Amps Per Bank	10	10
AC Cord Length	6'	6'
Size (W x H x L)	9.0" x 4.1" x 8.7"	9.0" x 4.1" x 8.7"
Weight (lbs)	8.0	8.5



Fan



Expanded LED display



Heavy-Duty strain reliefs

ProMariner™ Universal AC Plug Holder

- No cutting, stripping or splicing wires!
- Mount any AC plug in easy-to-use receptacle
- Black or white

- Part # 51202F Black
- Part # 51203F White
- OEM # 51202B Black
- OEM # 51203B White



Fully Automatic Multi-Stage Performance Charging Overview

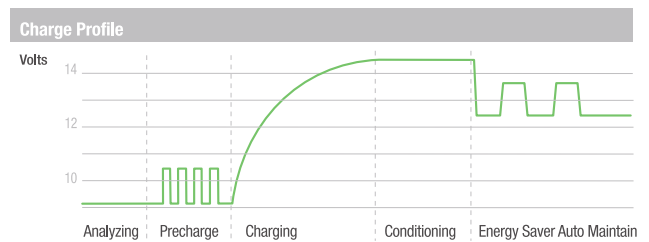

ChargePro's 5-Stage Performance Charging algorithm is fully automatic and designed to maximize battery performance and extend battery life.

Stage 1 - Analyze Mode: AC Power is applied. ChargePro's red Charging LED will flash indicating it is analyzing individual wiring connections for proper connection/polarity and that each battery is over 2.5 VDC and capable of accepting a precharge. When completed any errors will trip a battery specific red fault LED, or if no faults are present the red Charge LED will illuminate solid red.

Stage 2 - Precharge Mode: For batteries under 10 volts, this mode is designed to pulse the battery up to 10 volts before accepting full rated constant current (Stage3). During this mode the red charging LED will be illuminated with a solid on.

Stage 3 - Charging Mode Constant Current: During this mode the red charging LED will be illuminated with a solid on indicating each battery is being charge in constant current mode as controlled by temperature until the battery voltage is raised to a precise 14.6 volts DC and the red Charging LED will shut off.

Stage 4 - Conditioning Mode Constant Voltage: During this mode the amber Conditioning charging LED will be solid on indicating each battery is being is being conditioned at 14.6 volts for up to 3 hours until the battery is fully charged. Followed by the amber LED turning off while the charger enters into Stage 5.

Stage 5 - Storage Recondition Mode During this mode the blue AC Power and green Auto Maintain LED will be solid on indicating each battery is being monitored while the charger is in standby mode consuming little to no power until the battery drops under 12.8 volts (fully charged) and the charger will turn on and auto maintain the battery in a fully charged state. This is fully automatic and safe for short and long term storage.

1.5 Amp ChargePro™ Maintainer

Keep your battery charged with this highly reliable, Guest 1.5 Amp maintainer. Extends battery life and will charge, monitor and re-charge your battery if the voltage drops below 12.9V. The maintainer can be safely connected to the battery for short or long periods of time. To increase versatility the maintainer comes with alligator clips and ring terminals for the output cable. This maintainer will charge smaller batteries and maintain batteries up to 150Ah (group 31).

- Ideal for sport fishing boats, ski boats, jet ski's, ATVs, automobiles, tractors, riding lawn mowers and more
- For Wet, Gel and AGM batteries
- Charge batteries 1.2 Ah to 40 Ah
- Maintain batteries 1.2Ah to 150 Ah
- Energy savings mode automatically shuts off the charger when the battery is charged. The charger periodically monitors the battery and turns back on when the battery falls below 12.9V.
- Maintainer can safely stay connected to the battery for long periods of time
- LEDs let you know when the Power is ON, battery is being charged and when charging is complete.
- Includes ring terminals and alligator clips for connection to the battery
- Weather resistant, IP65
- 3-wire AC plug, NEMA 5-15P
- 3 year warranty
- Meets UL 1236 and CSA Standards, cETLus



Concealed Mounting



Expanded LED Status Center



Portable Foam Resting Pad



Included DC Cable Assemblies



NEMA 5-15P Plug

Part #	Output Volts	Output Amps	Banks	Cable Length	Size (WxHxD)	Weight	AC In
2701A	12V DC	1.5 Amps	1	6'	5.0"x5.8"x2.0"	2.3 lbs	120V AC 60Hz



Conforms to:
Marine UL 1236 SB
CSA C22.2 No. 107.2
FCC Class A

Designed and Constructed to:
ABYC A-31
ABYC
Setting Standards for Safer Boating

Portable Battery Chargers



	6 Amp Battery Charger	3 Amp Battery Charger
Part #	2606A	2603-B
Total Amps	6	3
Outputs	1	1
Amps per out	6	3
Battery System	12V	12V
Input Voltage	100-130V AC / 60Hz	100-130V AC/60Hz
Output Voltage	12V	12V
AC	6' AC cord with standard plug	18" AC cord with standard plug
Dimensions	5.5" x 5.0" x 2.4" 140x127x61 mm	3.10" x 3.50" x 2.34" 79x89x59 mm
Weight	3.5 lbs / 1.6 kg	1.0 lbs / 0.5 kg

ConnectCharge™ Inlets



Universal Mount

- Mount to dash from rear with threaded locking ring or from the front with three screws through the face plate

Part # 150CCI



Rear Mount

- Mounts to dash from rear with threaded locking ring
- Eliminates rewiring, plug snaps into Inlet locking tab
- Watertight lid protects AC plug

OEM # 150CCTM.OEM



Front Mount

- Mounts to panel from front with three screws through the face plate

OEM # 150CC.OEM

For use with Battery chargers with ConnectCharge™ Plug only!

Exclusive molded notch on plug locks into ConnectCharge™ inlet



Note: Not for use with ChargePro on-board battery chargers 2707A-2741A

Hard Wired Charger Inlets

- 15A or 20A 125V straight blade inlet
- Low profile cap won't catch fishing line
- Mounts easily to fiberglass and aluminum hulls
- Perma-Lock™ terminals and color coded wire entrance holes make wiring a snap
- UV resistant housing/cap



Amp	Color	Universal Mount Part #	Front Mount OEM #	Rear Mount OEM #
15	Black	150BBI	150BBI.OEM	150BBI-TM
15	White	150BBIW	150BBIW.OEM	—
20	White	—	200BBIW.OEM	—



15A 125V
Straight Blade



20A 125V
Straight Blade

BATTERY MANAGEMENT

Dynaplates

54

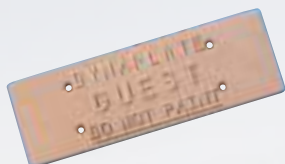

Improve the performance of electronics and reduce RF interference. Deters electrolysis and galvanic corrosion.

Universal Mount Switches

55



Longer stud length for easier assembly and cable routing.



BATTERY MANAGEMENT

Battery Selector Switches

55



Durable polycarbonate case. Available with or without Alternator Field Disconnect. For 6V, 12V, 24V, or 36V systems.

Heavy-duty Diesel Power Battery Switches

55



Constructed with heavy-duty copper sweep contacts to ensure positive circuit control. Features Alternator Field Disconnect to protect the electrical system during switching.



Battery Management systems protect and support rechargeable batteries by extending the charge and life cycle of your batteries.

Dynaplates for Hull Bonding & Grounding

- Improves performance of electronics and reduces RF interference
- Offers the best path for hull bonding without long runs of copper foil
- Deters electrolysis and galvanic corrosion
- Sintered porous bronze sphere construction for maximum conductivity in a compact size
- Low drag, non-fouling shape
- Easy to clean with wire brush
- Conforms to ABYC standards
- Mounting hardware included
- Gold plated mounting bolt
- Bronze mounting nuts

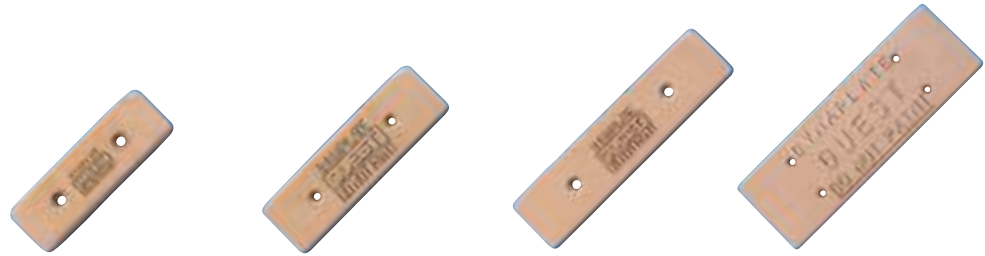

	Standard	Large	Giant	Super
Part #	4006	4008	4012	4018
Use for	bonding and grounding	bonding, grounding and Loran use	bonding, grounding and Loran use	SSB radio
Dimensions	6" x 2" x .5" 152 x 51 x 13 mm	8" x 2.5" x .5" 203 x 64 x 13 mm	12" x 3" x .5" 305 x 76 x 13 mm	18" x 6" x .5" 457 x 152 x 13 mm
Mounting holes	2-1/2" center to center	4" center to center	6" center to center	9.875" center to center; 3" top to bottom
Weight	1.4 lbs / .6 kg	2.1 lbs / 1 kg	3.7 lbs / 1.7 kg	11.1 lbs / 5 kg

Accessories for dynaplates

Part	Material	Use with:	Dimensions	Part #
Washer	Bronze	4006/4008	1/4" x 20"	P-11D03
		4012/4018	3/8" x 16"	P-11D04
Bolt	Bronze	4006/4008	1/4" x 20"	P-12D34
		4012/4018	3/8" x 16"	P-12D36
	Bronze Gold Plate	4006/4008	1/4" x 20"	P-12D35
		4012/4018	3/8" x 16"	P-12D37

Part	Material	Use with:	Dimensions	Part #
Nut	Bronze	4006/4008	1/4" x 20"	P-13A27
		4012/4018	3/8" x 16"	P-13A29
	Bronze Gold Plate	4006/4008	1/4" x 20"	P-13A28
		4012/4018	3/8" x 16"	P-13A2A

TECH tip™

Choosing a Battery Switch

ABYC requires a battery switch on every boat with a battery over 800 Cold Cranking Amps (CCA). This requirement exists so the potentially destructive energy in the batteries can be isolated in the event of a fire.

Universal Mount Switches

- Longer stud lengths for improved assembly and easier cable routing
- Built with heavy-duty copper sweep contacts to ensure positive circuit control
- Rugged internal components protected by a tough, impact resistant polycarbonate housing that is impervious to the elements
- Cable Lug Size: 3/8"
- Dimensions: 5.0" x 2.75"

Selector Switch w/out AFD

Continuous amps: 230
Momentary amps: 345



Part # 2111A
Part # 2111A-O orange
Part # 2111A-17 red
OEM # 2111A-B black

Selector Switch with AFD

Continuous amps: 230
Momentary amps: 345



Part # 2110A
OEM # 2110A-B black

On/Off Switch w/out AFD

Continuous amps: 230
Momentary amps: 345



Part # 2112A
OEM # 2112A-B black

Battery Selector Switches

- Polycarbonate case
- For 6V, 12V, 24V or 36V systems
- Surface mount
- Cable Lug Size: 3/8"
- Dimensions: 5.50" x 2.63"

Selector Switch with AFD

Continuous amps: 230
Momentary amps: 345



Part # 2100
OEM # 2100-B

Selector Switch w/out AFD

Continuous amps: 230
Momentary amps: 345



Part # 2101
OEM # 2101-B

On/Off Switch w/out AFD

Continuous amps: 230
Momentary amps: 345



Part # 2102
OEM # 2102-B

Heavy-duty Diesel Power Battery Switches

- For 6V, 12V, 24V or 36V systems
- Built with heavy-duty copper sweep contacts to ensure positive circuit control
- Rugged internal components protected by a tough, impact resistant polycarbonate housing that is impervious to the elements
- All feature Alternator Field Disconnect (AFD) allowing selection of any position, including "off", without damage to alternator or electrical system
- Cable lug size: 1/2"
- 2304A and 2304A-B have 3 studs

Heavy-duty On/Off Switch

Continuous amps: 450
Momentary amps: 800



Part # 2303A
OEM # 2303A-B

Extra-duty On/Off Switch

Continuous amps: 600
Momentary amps: 1000



Part # 2304A
OEM # 2304A-B

Battery Selector Switch

Continuous amps: 360
Momentary amps: 600



Part # 2300A
OEM # 2300A-B

Battery Switch Operation Diagrams

As more and more electronics and electrical accessories are added to your boat (autopilot, refrigeration, etc.) the use of multi-batteries becomes a necessity. Guest components allow you to set up the system (from simple to complex) for your boat's application. The following diagrams are for use in identifying and designing the right system for your boating needs.

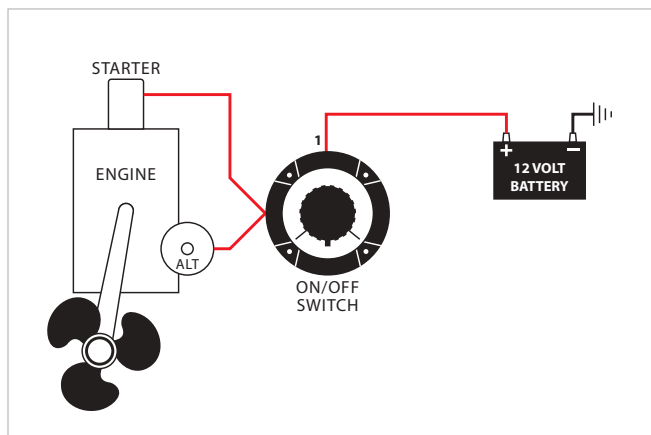

Single battery

Installation: To shut off all power at source. Recommended installation by approved authorities.

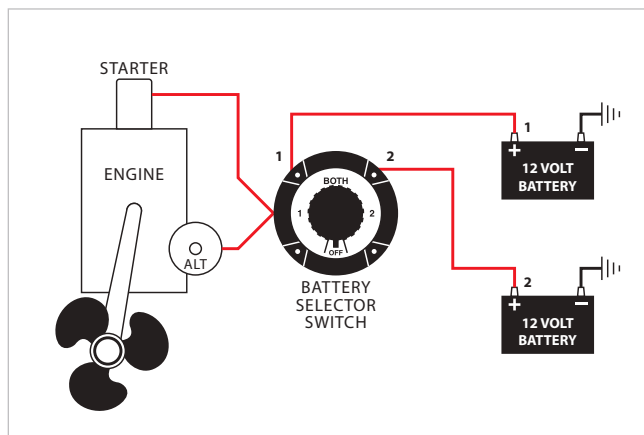

Two battery with out isolator

Installation: To select a starter battery and ship service battery. Manually isolates each battery, parallels both batteries for emergency start, master disconnect, manually selects batteries for charging.

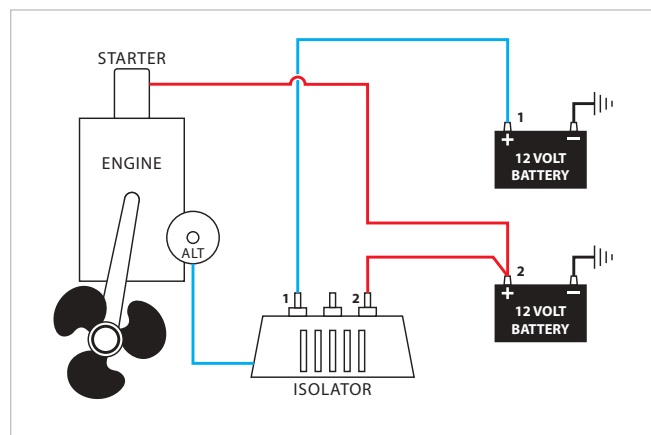

Two battery with isolator

Installation: Isolator automatically selects lower charged battery to be charged first. Full battery can't discharge to drained battery. Dedicated system, no flexibility, no emergency parallel or disconnect function.

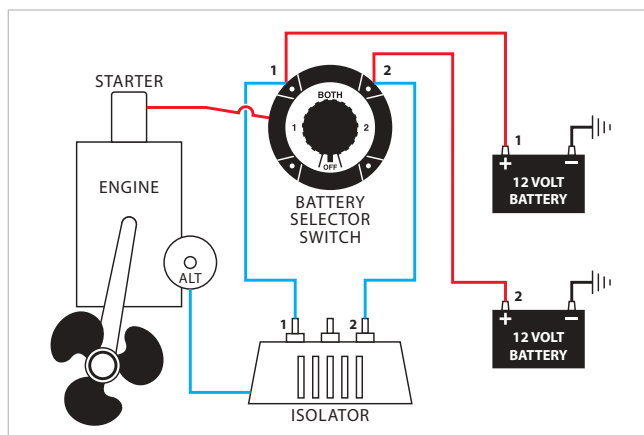

Two battery with emergency parallel

Installation: An isolator automatically isolates each battery, lower charged battery will automatically be charged first. Two different size batteries can be used, larger for ship services, smaller for engine cranking. Switch selects usage, master disconnect, emergency parallel function.

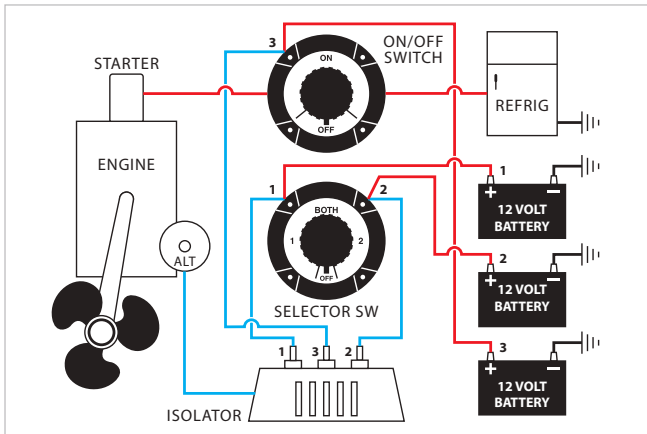

One battery selector switch, one On/Off selector switch automatic battery isolation and automatically charges three batteries

Installation: Use for sailboats and trawlers. Third battery isolated from other ship circuits. All batteries being automatically charged while running through isolator. To be used for refrigeration or other heavy load devices. Isolator protects other batteries.

Switch selector usage:

- 1. Master disconnect 2. Emergency parallel function

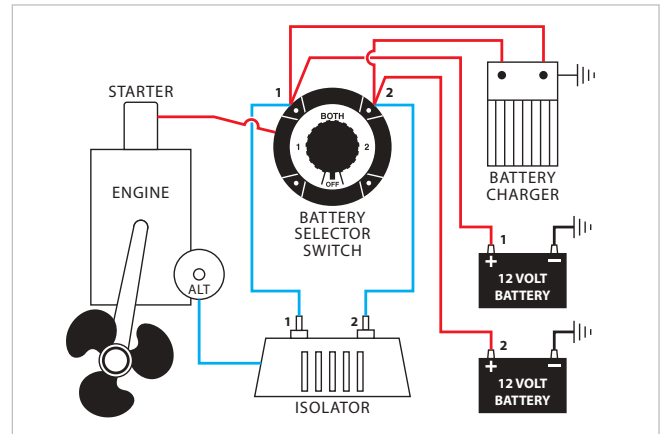

Adding automatic battery charger/converters to system

Installation: At dock side multi-bank charger built in isolator which will automatically charge lower battery.

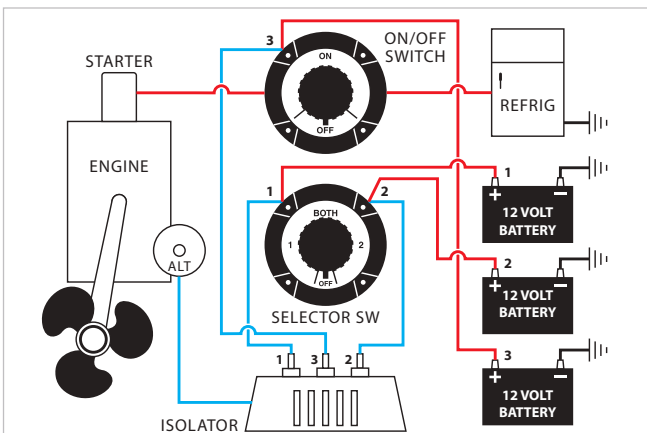

Three batteries, one battery selector switch, one On/Off or selector switch, two alternators, one isolator

Installation: Isolator separates both alternators so both alternators will charge simultaneously. Automatically charges lowest battery first. All batteries can be used for start, third battery, ship's source.

Alternator Field Disconnect (AFD)

Allows selection of any position, including "Off," without damage to alternator or electrical system. AFD is required on some electrical systems.

- Heavy-duty copper sweep contacts
- Positive click-stop on all positions
- "Make before break" contacts allow selection of all positions except "Off" while engine is running
- New design is easy to retrofit into existing hole patterns
- Use with 6V, 12V, 24V or 36V systems
- Built-in skirt protects connections
- Surface or rear panel mounting
- Marine grade construction

Important Note: The boater's electrical needs and problems should be discussed with your boatyard's electrical technician.



Exclusive flat 360 "sweep" contact design provides up to 60% more contact area than other switch designs.

WIPER SYSTEMS

Wiper Motors & Kits

60



Marinco® motors are split into three categories, Standard, Heavy-Duty, and Heavy-Duty Plus, with the categories being defined by the power range of the motors. Within the three categories, there are motors designed for interior or protected installations, and motors designed for exterior installations. We offer wiper motors for all windshield sizes up to 45", which could be covered by a 30" arm and 30" blade combination, driven by a 3.0 motor.

Wiper Arms

69



Wiper arms are available in Standard, Deluxe, and Premier styles and the primary construction material in all wiper arms is stainless steel. Deluxe arms are used on Standard and Heavy-Duty motors. The arms are available in a wide range of sizes, in both black and stainless steel finish, and regular and pantographic models. Pantographic arms use a set of two arms joined together to give a flatter and somewhat wider sweep pattern.



WIPER SYSTEMS

Wiper Blades

74

NEW



Standard, Deluxe and Premier Plus wiper blades are offered in different sizes and styles to fit all of the different types of wiper arms. Premier and Deluxe styles have stainless steel frame construction and high-end silicone rubber squeegees. For maximum performance of all blade styles, replacement of wiper blades is recommended every 6 months.

Windshield Washer Kits

75



A full line of easy-to-install windshield washer kits are available.



Wiper assembly systems ensure your visibility remains clear through a storm or vicious passages.

Wiper Motors

The motor choice is based primarily on the size of the windshield and where the motor is to be installed, either in an exterior or interior location. Marinco® motors are split into three categories, Standard, Heavy-Duty, and Heavy-Duty Plus, with the categories being defined by the power range of the motors. Within the three categories, there are motors designed for interior or protected installations, and motors designed for exterior installations. We offer wiper motors for all windshield sizes up to 45", which could be covered by a 30" arm and 30" blade combination, driven by a 3.0 motor.









The Standard motor category includes the STD, WMW, and 500, which are all designed for light duty use, defined as being able to drive a 14" arm and a 14" blade.

When coverage of a larger windshield is required, Marinco® offers the Heavy-Duty motors, which are capable of driving a

wide range of arm and blade sizes, up to a 26" x 26" Deluxe arm and blade combination, which would cover windshields up to 39". The 1000 motor can pull up to a 16" x 16" Deluxe arm and blade combination. The MRV is built for interior or well-protected locations, and has the power to pull a 22" x 22" Deluxe arm and blade combination. The 1.5 motor has the power to pull a 22" x 22" Deluxe arm and blade combination like the MRV, but is waterproof and built for exposed installations. The 2.5 motor has the power to pull a 26" x 26" Deluxe arm and blade combination and is waterproof for exposed installations.

The 3.0 motor is the motor that makes up the Heavy-Duty Plus category. This motor has an external linkage shaft drive that gives it the power and torque to drive a 30" Premier pantographic arm and Premier blade combination.

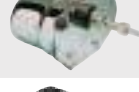
Choosing the Right Motor

	Model	Voltage	Speeds	Stall Torque/ Stall Current	Compatible Blade Lengths	Available Shaft Lengths	Sweep Angles	Housing
	3.0	12V & 24V	Single	165 in-lbs / 12.5-14.5 amps	30" Premier Plus single or pantographic	2.5" 3.5"	Factory preset to 110° Adjustable to 45°, 60°	External linkage - no housing
	2.5	12V & 24V	2 speed	139 in-lbs / 9-10.5 amps	26" Deluxe 24" Premier	1.5" 2.5"	Factory preset: 80° or 110° Adjustable: 45° or 60°	Fully sealed powder coated aluminum
	1.5	12V & 24V	2 speed	109 in-lbs / 11.5-13 amps	22" Deluxe 20" Premier	1.5" 2.5"	Factory preset: 80° or 110° Adjustable: 45° or 60°	Fully sealed powder coated aluminum
	3000	12V	2 speed	159 in-lbs / 10.2-12.2 amps	26" Deluxe 26" Premier	1.5" 2.5"	Factory preset: 80° or 110° Adjustable to 40°, 50°, 60°, 70°, 80°, 90°, 100° or 110°	Fully sealed aluminum
	1000	12V	Single	55 in-lbs / 9.8-10 amps	16" Deluxe 18" Premier	1.5" 2.5"	Factory preset: 80° or 110° Adjustable: 50°, 65°, 80° or 110°	Fully sealed, UV stabilized hi-temp thermoplastic
	MRV	12V & 24V	2 speed (but can be operated as 1)	109 in-lbs / 11.5-13 amps	22" Deluxe 20" Premier (at 80° sweep)	1.5" 2.5" 3.5"	Factory preset: 80° or 110° Adjustable: 45°, 60°, 80° or 110°	Corrosion resistant cast housing
	500	12V	Single	—	14" Deluxe	2.5"	Factory preset: 80° or 110°	Fully sealed, UV stabilized hi-temp thermoplastic
	WMW	12V	Single	—	14" Deluxe	2.5"	Factory preset: 110°	Chrome plated brass case
	STD	12V	Single	—	14" Deluxe	2.5" 3.5"	Factory preset: 80° or 110° Adjustable: 80° or 110°	Corrosion proof aluminum alloy case



3 YEAR WARRANTY



Heavy Duty Plus 3.0 Motor

The Heavy Duty Plus 3.0 Motor is Marinco®'s only external linkage motor. This design easily powers a 30" Premier arm and 30" Premier Plus blade combination to provide coverage up to 45" of windshield area.

- Available in two shaft lengths: 2.5" and 3.5" (knurled arm fitting adds 2" to overall length)
- Tapered knurled drive shaft
- Factory pre-set sweep angle of 110°, with easy adjustment to 45° or 60°
- Sealed 6" wire leads, 16 AWG
- For interior installations
- Adjustable right or left self parking
- 18 mm diameter shaft
- Measures approximately 8.5" L x 4.625" W x 4.375" D (See below for detailed dimensional drawings)
- Stall torque: 165 in-lbs (190 kgf/cm; 18.6 Nm)
- Stall current: 12.5–14.5 amps
- No load current: 0.8–2.0 amps
- Recommended fuse: 6 amp fuse
- Available in 12V and 24V models
- Coast to park
- RF shielded circuitry

	Voltage	Sweep	OEM #
3.5" Shaft	12V	110°	73113
	24V	110°	73313

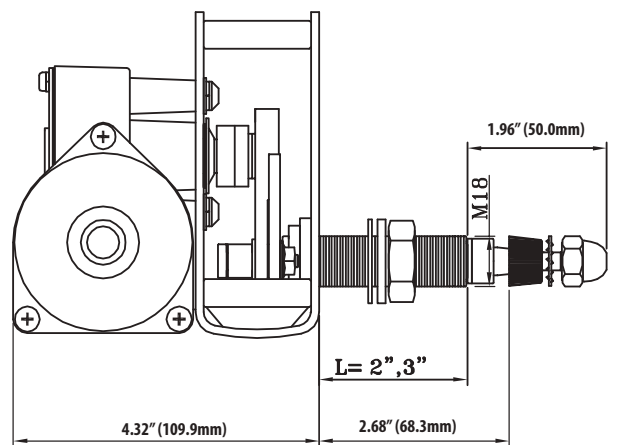
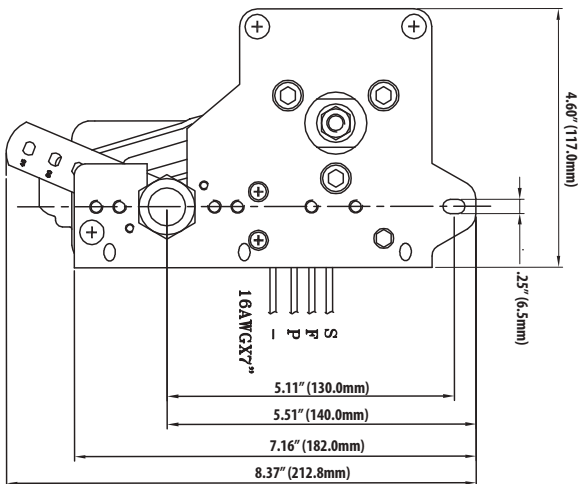



3 YEAR WARRANTY
CE

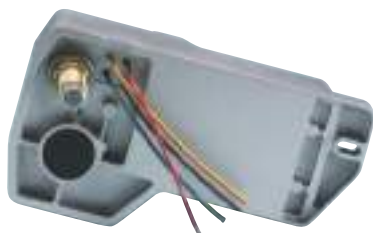

2.5 Waterproof Wiper Motor

- Fully sealed powder coated aluminum waterproof base and housing
- Powers a 26" Deluxe arm and Deluxe blade combination or a 24" Premier arm and Deluxe blade combination
- Available in two shaft lengths: 1.5" and 2.5" (includes .5" length of knurled arm fitting)
- Factory pre-set sweep angles of 80° or 110°, with easy adjustment to 45° or 60°
- Chrome plated solid brass knurled drive nut with brass and stainless steel drive shaft
- Two speed motor
- Sealed 6" wire leads, 16 AWG
- Adjustable right or left self parking
- .625" diameter shaft (16 mm)
- Available in 12V and 24V models
- Coast to park
- RF shielded circuitry
- Retail version includes 6 amp fuse and holder (operating switch not included)
- Measures approximately 7.875" L x 4.25" W x 3" D (see below for detailed dimensional drawings)
- Stall torque: 139 in-lbs (160 kgf/cm; 15.7 Nm)
- Stall current: 9.0-10.5 amps
- No load current: 1.0 -1.6 amps

	Voltage	Sweep	Part #	OEM #
1.5" Shaft	12V	80°	82081	82181
	12V	80°	82082	82182
2.5" Shaft	12V	110°	82012	—
	24V	110°	82312	82212

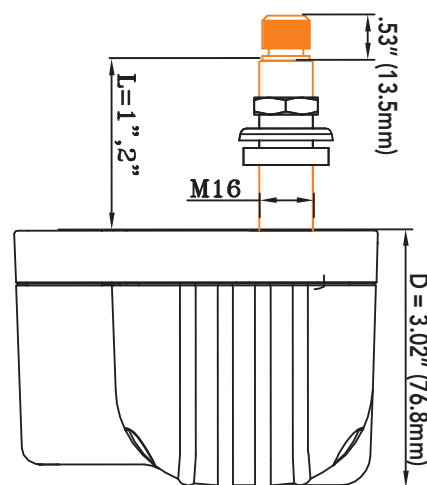
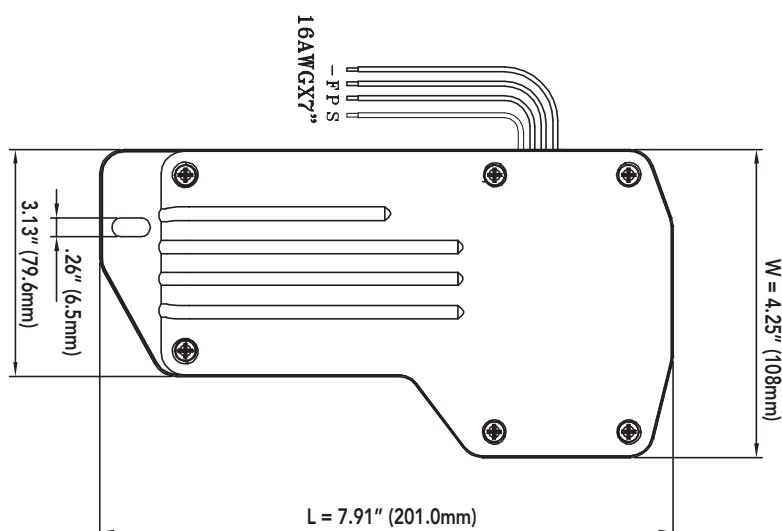



3 YEAR WARRANTY
CE



1.5 Waterproof Wiper Motor

- Fully sealed powder coated aluminum waterproof base and housing
- Powers a 22" Deluxe arm and 22" Deluxe blade combination or a 20" Premier arm and 20" Deluxe blade combination
- Available in three shaft lengths: 1.5" and 2.5" (includes .5" length of knurled arm fitting)
- Factory pre-set sweep angles of 80° or 110°, with easy adjustment to 45° or 60°
- Chrome plated solid brass knurled drive nut with brass and stainless steel drive shaft
- Two speed motor
- Sealed 6" wire leads, 16 AWG
- Adjustable right or left self parking
- .625" diameter shaft (16 mm)
- Available in 12V
- Coast to park
- RF shielded circuitry
- Retail version includes 5 amp fuse and holder (operating switch not included)
- Measures approximately 7.75" L x 4" W x 2.75" D (see below for detailed dimensional drawings)
- Stall torque: 109 in-lbs (125 kgf/cm; 12.3 Nm)
- Stall current: 11.5-13.0 amps
- No load current: 0.5-1.2 amps
- Replaces AFI 2000 motor

	Voltage	Sweep	Part #	OEM #
1.5" Shaft	12V	80°	71081	—
	12V	110°	71011	—
2.5" Shaft	12V	80°	71082	71182
	12V	110°	71012	71112

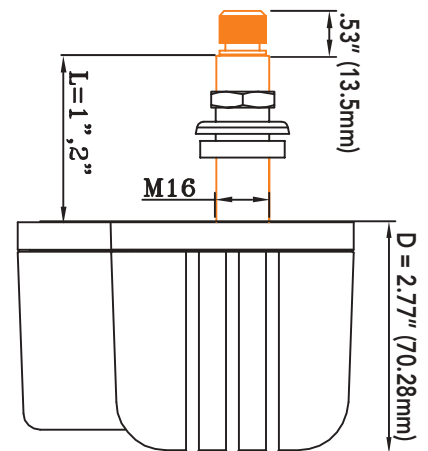
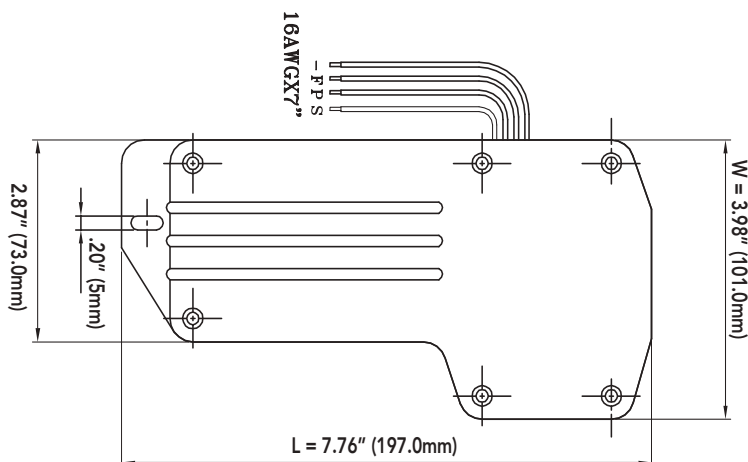



**3 YEAR
WARRANTY**



3000 Waterproof Wiper Motor

- Fully sealed powder coated aluminum waterproof base and housing
- Powers a 26" Deluxe arm and Deluxe blade combination or a 24" Premier arm and Deluxe blade combination
- Available in two shaft lengths: 1.5" and 2.5" (includes .5" length of knurled arm fitting)
- .625" diameter shaft (16 mm)
- Factory preset sweep angles of 80° or 110°, with easy adjustment from 40° to 110° at 10° increments
- Sealed 6" wire leads, 16 AWG
- Adjustable right or left self parking
- Two speed settings
- Retail version includes 5 amp fuse and holder (on/off switch not included)
- Isolated ground
- Stall torque: 159 in-lbs (183 kgf/cm; 18 Nm)
- Stall current: 10.2-12.20 amps
- IP66 rated

	Voltage	Sweep	Part #	OEM #
1.5" Shaft	12V	80°	83081	83181
	12V	110°	83011	83111
2.5" Shaft	12V	80°	83082	83182
	12V	110°	83012	83112

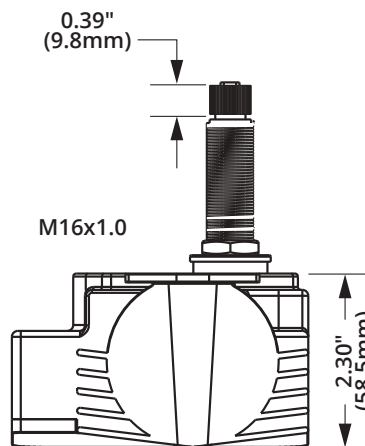
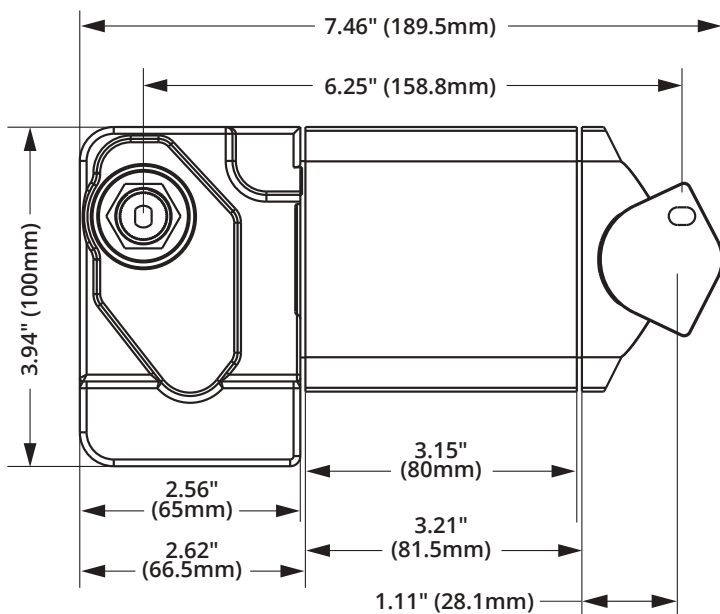



3 YEAR WARRANTY
CE



1000 Waterproof Wiper Motor

- Powers 18" Deluxe arm and 18" Deluxe blade combination at sweep sets of 80° or less (not compatible with pantograph arms)
- Powers 16" Deluxe arm and 16" Deluxe blade combinations at a sweep set of 110° (not compatible with pantograph arms)
- Factory pre-set sweep of 80° or 110° adjustable to 50°, 65°, 80°, or 110°
- .625" diameter shaft (16 mm)
- Fully sealed waterproof housing made of UV stabilized, high-temperature, high-impact thermoplastic
- 12 volt heavy-duty motor with anti-rotation drive shaft
- Knurled drive shaft and solid brass arm drive nut
- Coast to park with adjustable right or left self parking
- Retail version includes 5 amp fuse and holder (on/off switch not included)
- RF shielded circuitry
- Weight: 1.75 lbs
- Available in two shaft lengths: 1.5" and 2.5" (includes .5" length of knurled arm fitting)
- Measures approximately 6.625" L x 3.375" W x 2" D
- Stall torque: 55 in-lbs (63 kgf/cm; 6.2 Nm)
- Stall current: 9.8-10.0 amps
- No load current: 0.8-1.2 amps

	Voltage	Sweep	Item#	OEM #
1.5" Shaft	12V	65°	—	36161
		80°	36180	36181
		110°	36110	36111
2.5" Shaft	12V	65°	—	37161
		80°	37180	37181
		110°	37110	37111
2.5" Shaft Kits	12V	80°	37100	—
		110°	37200	—

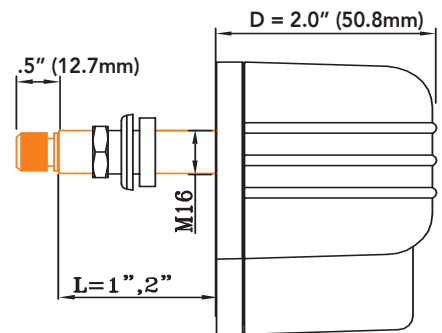
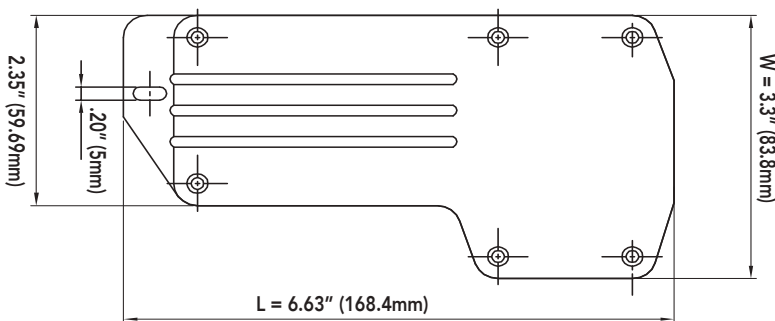



3 YEAR WARRANTY



MRV Wiper Motor

- Easily powers 22" x 22" deluxe arm/blade combinations, or a 20" x 20" premier arm/blade combination at sweep sets of 80° or less
- Factory pre-set sweep of 80° or 110° adjustable from 40° to 110° in 10° increments
- .625" diameter shaft (16 mm)
- Available in 3 shaft lengths: 1.5", 2.5" and 3.5" (includes .5" length of knurled arm fitting)
- Corrosion-resistant casing
- Heavy-duty motor with right angle drive
- Two-speed motor, can be operated as one speed
- Solid brass knurled drive nut with brass and stainless steel drive shaft
- Adjustable right or left self parking, coast to park
- Retail version includes 5 amp fuse and holder
- Stainless steel fasteners and mounting bracket
- Use with three-position switch (not included)
- Compact size – 7.625" L x 4" W x 2" D
- Stall torque: 109 in-lbs (125 kgf/cm: 12.3 Nm)
- Stall current: 11.5–13.0 amps
- No load current: 0.5–1.2 amps

	Voltage	Sweep	Item#	OEM #
1.5" Shaft	12V	80°	34001	38001
		110°	34011	38011
2.5" Shaft	12V	80°	34000	38000
		110°	34010	38010
3.5" Shaft	24V	110°	34210	—
		80°	34005	38005
		110°	34015	—

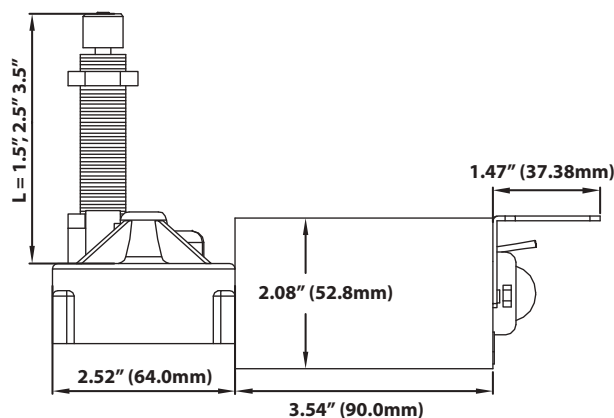
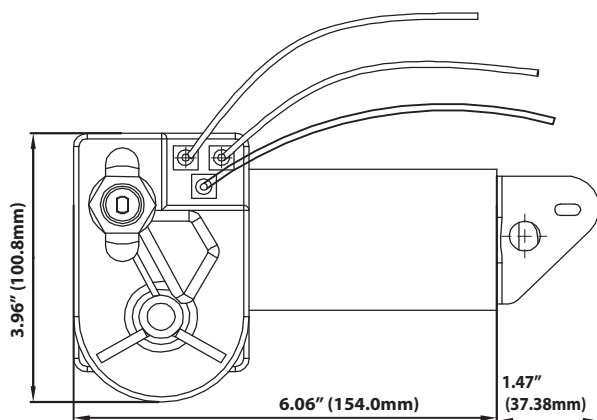

MRV Wiper Motor Cover

- Constructed of white ABS plastic
- Easily installed

Part # 33025 White
OEM # 33125 White
OEM # 33126 Black

WMW Wiper Motor

Windshield Mount: .375" shaft diameter

- Powers up to 14" x 14" arm/blade combinations
- Water-resistant sealed motor
- Chrome-plated brass case and shaft housing
- Stainless steel front plate and wiper shaft
- Maximum current draw: 2 amps
- Shaft diameter: .375"
- For external use in open cabin boats
- Dimensions: 4.25" L x 2.75" W x 3.5" D

	Voltage	Sweep	Part #	OEM #
2.5" Shaft	12V	80°	—	35000
		110°	—	35010



3 YEAR WARRANTY

STD Wiper Motor

Windshield Mount: .375" shaft diameter

Deck Mount: .5" shaft diameter

- Deck Mount version includes deck mount adapter kit (33000)
- Powers up to 14" x 14" arm/blade combinations
- Corrosion-proof aluminum alloy case with black crackle finish
- Base & mounting plates are chrome plated naval brass
- Maximum current draw: 2 amps
- 80° or 110° adjustable sweep, adjustable right or left self-parking
- Shaft diameter: .375" windshield mount, .5" deck mount
- Dimensions: 3.875" L x 2.25" W x 3.5" D

	Voltage	Sweep	Part #	OEM #
2.5" Shaft	12V	80°	35040	—



3 YEAR WARRANTY



3 YEAR WARRANTY

WMW Wiper Motor Kit

Windshield Mount: .375" shaft diameter

- Powers up to 14" x 14" arm/blade combinations
- Water-resistant sealed motor
- Chrome-plated brass case and shaft housing
- Stainless steel front plate and wiper shaft
- Maximum current draw: 2 amps
- Shaft diameter: .375"
- For external use in open cabin boats
- Dimensions: 4.25" L x 2.75" W x 3.5" D

Kit includes:

- WMW Wiper Motor
- 11.5" Deluxe stainless steel curved blade (33004)
- Deluxe adjustable (6.75" to 10.5") stainless steel arm (33006AS)

	Voltage	Sweep	Part #	OEM #
2.5" Shaft	12V	80°	30000	—
2.5" Shaft	12V	110°	30002	—



3 YEAR WARRANTY

STD Wiper Motor Kit

Windshield Mount: .375" shaft diameter

Deck Mount: .5" shaft diameter

- Deck Mount version includes deck mount adapter kit (33000)
- Powers up to 14" x 14" arm/blade combinations
- Corrosion-proof aluminum alloy case with black crackle finish
- Base & mounting plates are chrome plated naval brass
- Maximum current draw: 2 amps
- 80° or 110° adjustable sweep, adjustable right or left self-parking
- Shaft diameter: .375" windshield mount, .5" deck mount
- Dimensions: 3.875" L x 2.25" W x 3.5" D

Kit includes:

- STD Wiper Motor (recommended for interior installations only)
- 11.5" Deluxe stainless steel curved blade (33004)
- Deluxe adjustable (6.75" to 10.5") stainless steel arm (33006AS)

	Voltage	Sweep	Part #	OEM #
2.5" Shaft	12V	80°	—	32000
		110°	—	32002
3.5" Shaft	12V	80°	—	32001



3 YEAR WARRANTY

500 Wiper Kit

Windshield Mount: .5" shaft diameter

Kit includes:

- 500 Waterproof Wiper Motor
- 11.5" Deluxe stainless steel curved blade (33004)
- Deluxe adjustable (6.75" to 10.5") stainless steel arm (33006AS)

	Voltage	Sweep	Part #
2.5" Shaft	12V	80°	30004
2.5" Shaft	12V	110°	30005



Hand-operated Wiper Blade

- Chrome-plated brass handle
- Includes stainless steel 7-1/2" to 12" adjustable wiper arm, 11" blade, and all parts for installation
- Economical—an inexpensive alternative to wiper motor kit
- Requires 7/16" diameter hole for installation
- Can be installed up to 7/8" thick material
- For use on flat windshields only

Part # 31000
OEM # 33101 Replacement blade

Wiper Arms

Wiper arms are available in Standard, Deluxe, and Premier styles and the primary construction material in all wiper arms is stainless steel. Standard arms are used with Standard blades and can only be used with the line of Standard motors, while the Deluxe arms are used on Standard and Heavy-Duty motors. When choosing arms (and blades) it is very important to use only the recommended lengths for the motor that you are using.

The arms are available in a wide range of sizes, in both black and stainless steel finish, and regular and pantographic models. Pantographic arms use a set of two arms joined together to give a flatter and somewhat wider sweep pattern. The Deluxe arms are available in a polished stainless steel finish or a black powder-coated finish. Premier arms are the top of the line product in this category, utilizing heavy-duty stainless steel tubing and components, and they can only be used with the Heavy Duty and Heavy Duty Plus motors. Premier arms come in adjustable length sizes, ranging from 10" to 30", in both regular and pantographic versions. The longer length Premier arms (25"-30" long) have been designed for added strength and have a tapered wiper shaft fitting made especially to fit the larger, more powerful 3.0 wiper motor. These arms also have a saddle style tip for a stronger connection with the longer length Premier blades (26", 28", and 30" lengths).

Premier arms are also available as "wet arm" versions, with the water hose and sprayer nozzle built into the wiper arm. All that is needed is a water delivery system that the arm can be tied into. For those wanting a windshield washer system for the Deluxe arms, there is a complete washer kit system that is made especially to fit the Deluxe arms.



Wiper Arm Compatibility Chart

Style	Wet/ Dry	Length (adjustable)	Color	Material	Part #	OEM #	Motor Compatibility Chart					
							3.0	2.5	3000	1.5	1000	MRV
Premier Plus												
single	dry	25"-30"	stainless	stainless	—	33188	✓	-	-	-	-	-
single	wet	25"-30"	stainless	stainless	—	33188W	✓	-	-	-	-	-
Premier												
single	dry	10"-15"	stainless	stainless	33082	33182	-	✓	✓	✓	-	✓
single	dry	15"-20"	stainless	stainless	33084	33184	-	✓	✓	✓	-	✓
single	dry	20"-25"	stainless	stainless	33086	33186	-	✓	✓	-	-	-
single	wet	15"-20"	stainless	stainless	33084W	33184W	-	✓	✓	✓	-	✓
single	wet	20"-25"	stainless	stainless	33086W	33186W	-	✓	✓	-	-	-
pantographic	dry	12"-17"	stainless	stainless	33090	33190	-	✓	✓	✓	-	✓
pantographic	dry	17"-22"	stainless	stainless	33092	33192	-	✓	✓	-	-	max 20"
pantographic	dry	22"-26"	stainless	stainless	33094	33194	-	✓	✓	-	-	-
pantographic	wet	12"-17"	stainless	stainless	33090W	—	-	✓	✓	✓	-	✓
pantographic	wet	17"-22"	stainless	stainless	33092W	33192W	-	✓	✓	-	-	max 20" ≤ 80"
pantographic	wet	22"-26"	stainless	stainless	—	33194W	-	✓	✓	-	-	-
Deluxe Adjustable												
single	dry	6.75"-10.5"	stainless	stainless	33006A	33106A	-	✓	✓	✓	✓	✓
single	dry	10"-14"	stainless	stainless	33007A	33107A	-	✓	✓	✓	✓	✓
single	dry	14"-20"	stainless	stainless	33010A	33110A	-	✓	✓	✓	max 18" ≤ 80° max 16" @ 110°	✓
single	dry	10"-14"	black	stainless	33012A	33112A	-	✓	✓	✓	✓	✓
single	dry	14"-20"	black	stainless	33014A	33114A	-	✓	✓	✓	max 18" ≤ 80° max 16" @ 110°	✓
single	dry	18"-24"	black	stainless	33070A	33170A	-	✓	✓	-	-	max 22"
Deluxe Pantographic												
pantographic	dry	12"-17"	black	stainless	33032A	33132A	-	✓	✓	✓	-	✓
pantographic	dry	17"-22"	black	stainless	33037A	33137A	-	✓	✓	✓	-	✓

Premier Plus Stainless Steel Adjustable Single and Pantographic Wiper Arm

- Heavy-duty component design for use with the 3.0 wiper motor
- Stainless steel and chrome-plated die cast construction
- Motor shaft mount with notched "teeth" and tapered design for secure operation
- Features "Articulating/Bend Back" design that locks arm in upright position for windshield cleaning



single - adjusts 25" to 30"

Style	Wet/Dry	Length (adjustable)	Color	Material	Part #	OEM #
single	dry	25"-30"	stainless	stainless	—	33188

Note: For use only with Premier Plus Wiper Blades and Heavy Duty Plus 3.0 Motor

Premier Plus Stainless Steel Single and Pantographic Wet Arms

- Premier wet arms add a built-in washer system to the high-end, heavy duty construction of the Premier wiper arms
- Premier wet arms feature a black PVC hose that runs up the center of the arm and ends in a four-nozzle fixture that is part of the arm itself
- Each solid brass nozzle is adjustable for maximum coverage



Style	Wet/Dry	Length (adjustable)	Color	Material	Part #	OEM #
single	wet	25"-30"	stainless	stainless	—	33188W

Note: For use only with Premier Plus Wiper Blades and Heavy Duty Plus 3.0 Motor

Premier Stainless Steel Single and Pantographic Dry Arms

- Heavy-duty component design for use with most Marinco® motors
- Stainless steel construction
- Features "Articulating/Bend Back" design that locks arm in upright position for windshield cleaning
- Motor shaft mount with notched teeth



Single



Pantographic

Style	Wet/Dry	Length (adjustable)	Color	Material	Part #	OEM #
single	dry	15"-20"	stainless	stainless	33084	33184
single	dry	20"-25"	stainless	stainless	33086	33186
pantographic	dry	12"-17"	stainless	stainless	33090	33190
pantographic	dry	17"-22"	stainless	stainless	33092	33192
pantographic	dry	22"-26"	stainless	stainless	33094	33194

Pantographic wiper arms will only function properly with wiper motor sweep angles 80° or less

Premier Stainless Steel Wiper Wet Arms

- Heavy-duty component design for use with most Marinco® motors
- Features “Articulating/ Bend Back” design that locks arm in upright position for windshield cleaning
- Built-in wet arm system that allows for a clean and easy installation of a washer system
- Black PVC hose runs up the center of the arm and ends in an adjustable four-nozzle fixture that is an integral part of the wiper arm itself



Style	Wet/Dry	Length (adjustable)	Color	Material	Part #	OEM #
single	wet	15"-20"	stainless	stainless	33084W	33184W
single	wet	20"-25"	stainless	stainless	33086W	33186W
pantographic	wet	17"-22"	stainless	stainless	33092W	33192W

Pantographic wiper arms will only function properly with wiper motor sweep angles 80° or less

Deluxe Adjustable Wiper Arm

- All arms are stainless steel
- Arm has “articulating/ bend-back” feature
- Motor shaft mounting has additional set screw clamping



Style	Wet/Dry	Length (adjustable)	Color	Material	Part #	OEM #
single	dry	6.75"-10.5"	stainless	stainless	33006A	33106A
single	dry	10"-14"	stainless	stainless	33007A	33107A
single	dry	14"-20"	stainless	stainless	33010A	33110A
single	dry	10"-14"	black	stainless	33012A	—
single	dry	14"-20"	black	stainless	33014A	33114A
single	dry	18"-24"	black	stainless	33070A	33170A

Deluxe Adjustable Pantographic Arm

- For Use with 2.5, 1.5 and MRV Motors
- Stainless steel
- Arm has “articulating/ bend-back” feature
- Motor shaft mounting has additional set screw clamping



Style	Wet/Dry	Length (adjustable)	Color	Material	Part #	OEM #
pantographic	dry	12"-17"	black	stainless	33032A	33132A
pantographic	dry	17"-22"	black	stainless	33037A	33137A



Premier Plus Blades

Color/ Material	Length	Stainless/ Stainless			Black/ Stainless	
		26"	28"	30"	26"	28"
Premier Plus Wiper Arms						
Single Arm						
33088 33188	dry	33026S 33126S	33028S	33030S 33130S	33026B 33126B	33028B
33088W 33188W	wet	33026S 33126S	33028S	33030S 33130S	33026B 33126B	33028B
Pantograph						
33096 33196	dry	33026S 33126S	33028S	33030S 33130S	33026B 33126B	33028B
33096W 33196W	wet	33026S 33126S	33028S	33030S 33130S	33026B 33126B	33028B

Wiper Blade Selection Charts

Step 1: Find the type and Part # of wiper arm you have along the left side of the chart.

Step 2: Follow along to the right until you match up with the type and length of wiper blade you want.

Step 3: Bold is the Part # and the lighter is the OEM# (if available).

NEW



NEW



Deluxe Blades

Color/ Material	Length	Stainless/ Stainless											Black/ Stainless			
		12"	14"	16"	18"	20"	22"	24"	26"	12"	14"	16"	18"			
Premier Wiper Arms																
Single Arm																
33082 33182	dry	34012S 34112S	34014S 34114S	34016S 34116S	34018S 34118S	34020S 34120S	34022S 34122S	34024S 34124S	34026S 34126S	34012B 34112B	34014B 34114B	34016B 34116B	34018B 34118B			
33084 33184	dry	34012S 34112S	34014S 34114S	34016S 34116S	34018S 34118S	34020S 34120S	34022S 34122S	34024S 34124S	34026S 34126S	34012B 34112B	34014B 34114B	34016B 34116B	34018B 34118B			
33084W 33184W	wet	34012S 34112S	34014S 34114S	34016S 34116S	34018S 34118S	34020S 34120S	34022S 34122S	34024S 34124S	34026S 34126S	34012B 34112B	34014B 34114B	34016B 34116B	34018B 34118B			
33086 33186	dry	34012S 34112S	34014S 34114S	34016S 34116S	34018S 34118S	34020S 34120S	34022S 34122S	34024S 34124S	34026S 34126S	34012B 34112B	34014B 34114B	34016B 34116B	34018B 34118B			
33086W 33186W	wet	34012S 34112S	34014S 34114S	34016S 34116S	34018S 34118S	34020S 34120S	34022S 34122S	34024S 34124S	34026S 34126S	34012B 34112B	34014B 34114B	34016B 34116B	34018B 34118B			
Pantograph Arm																
33090 33190	dry	34012S 34112S	34014S 34114S	34016S 34116S	34018S 34118S	34020S 34120S	34022S 34122S	34024S 34124S	34026S 34126S	34012B 34112B	34014B 34114B	34016B 34116B	34018B 34118B			
33090W 33190W	wet	34012S 34112S	34014S 34114S	34016S 34116S	34018S 34118S	34020S 34120S	34022S 34122S	34024S 34124S	34026S 34126S	34012B 34112B	34014B 34114B	34016B 34116B	34018B 34118B			
33092 33192	dry	34012S 34112S	34014S 34114S	34016S 34116S	34018S 34118S	34020S 34120S	34022S 34122S	34024S 34124S	34026S 34126S	34012B 34112B	34014B 34114B	34016B 34116B	34018B 34118B			
33092W 33192W	wet	34012S 34112S	34014S 34114S	34016S 34116S	34018S 34118S	34020S 34120S	34022S 34122S	34024S 34124S	34026S 34126S	34012B 34112B	34014B 34114B	34016B 34116B	34018B 34118B			
33094 33194	dry	34012S 34112S	34014S 34114S	34016S 34116S	34018S 34118S	34020S 34120S	34022S 34122S	34024S 34124S	34026S 34126S	34012B 34112B	34014B 34114B	34016B 34116B	34018B 34118B			
33094W 33194W	wet	34012S 34112S	34014S 34114S	34016S 34116S	34018S 34118S	34020S 34120S	34022S 34122S	34024S 34124S	34026S 34126S	34012B 34112B	34014B 34114B	34016B 34116B	34018B 34118B			
Deluxe Wiper Arms																
Single Arm																
33006A 33106A	dry	34012S 34112S	34014S 34114S	34016S 34116S	34018S 34118S	34020S 34120S	34022S 34122S	34024S 34124S	34026S 34126S	34012B 34112B	34014B 34114B	34016B 34116B	34018B 34118B			
33007A 33107A	dry	34012S 34112S	34014S 34114S	34016S 34116S	34018S 34118S	34020S 34120S	34022S 34122S	34024S 34124S	34026S 34126S	34012B 34112B	34014B 34114B	34016B 34116B	34018B 34118B			
33010A 33110A	dry	34012S 34112S	34014S 34114S	34016S 34116S	34018S 34118S	34020S 34120S	34022S 34122S	34024S 34124S	34026S 34126S	34012B 34112B	34014B 34114B	34016B 34116B	34018B 34118B			
33012A 33112A	dry	34012S 34112S	34014S 34114S	34016S 34116S	34018S 34118S	34020S 34120S	34022S 34122S	34024S 34124S	34026S 34126S	34012B 34112B	34014B 34114B	34016B 34116B	34018B 34118B			
33014A 33114A	dry	34012S 34112S	34014S 34114S	34016S 34116S	34018S 34118S	34020S 34120S	34022S 34122S	34024S 34124S	34026S 34126S	34012B 34112B	34014B 34114B	34016B 34116B	34018B 34118B			
33070A 33170A	dry	34012S 34112S	34014S 34114S	34016S 34116S	34018S 34118S	34020S 34120S	34022S 34122S	34024S 34124S	34026S 34126S	34012B 34112B	34014B 34114B	34016B 34116B	34018B 34118B			
Pantograph Arm																
33032A 33132A	dry	34012S 34112S	34014S 34114S	34016S 34116S	34018S 34118S	34020S 34120S	34022S 34122S	34024S 34124S	34026S 34126S	34012B 34112B	34014B 34114B	34016B 34116B	34018B 34118B			
33037A 33137A	dry	34012S 34112S	34014S 34114S	34016S 34116S	34018S 34118S	34020S 34120S	34022S 34122S	34024S 34124S	34026S 34126S	34012B 34112B	34014B 34114B	34016B 34116B	34018B 34118B			

Pantographic wiper arms will only function properly with wiper motor sweep angles 80° or less

Wiper Blades

Standard, Premier, and Deluxe wiper blades are offered in different sizes and styles to fit all of the different types of wiper arms. Standard styles have plastic frame construction and marine grade rubber squeegees.

Premier and Deluxe styles have stainless steel frame construction and high-end silicone rubber squeegees. These two styles have multiple frame construction, allowing for equal pressure of the entire length of the blade and silicone rubber squeegees that are durable and create a smoother wiping motion. In addition, longer length Premier Plus blades (26", 28", and 30") are specifically designed with a saddle style attachment for the longer length Premier Plus arms. (25"-30").

For maximum performance of all blade styles, replacement of wiper blades is recommended every 6 months.



Deluxe Blades (cont)

Standard Blades

Black/ Stainless (cont)				Black/ Polymer							
20"	22"	24"	26"	12"	14"	16"	18"	20"	22"	24"	
34020B 34120B	34022B 34122B	34024B 34124B	34026B 34126B	31012B 31112B	31014B 31114B	31016B 31116B	31018B 31118B	31020B 31120B			
34020B 34120B	34022B 34122B	34024B 34124B	34026B 34126B	31012B 31112B	31014B 31114B	31016B 31116B	31018B 31118B	31020B 31120B	31022B 31122B	31024B 31124B	
34020B 34120B	34022B 34122B	34024B 34124B	34026B 34126B	31012B 31112B	31014B 31114B	31016B 31116B	31018B 31118B	31020B 31120B	31022B 31122B	31024B 31124B	
34020B 34120B	34022B 34122B	34024B 34124B	34026B 34126B	31012B 31112B	31014B 31114B	31016B 31116B	31018B 31118B	31020B 31120B	31022B 31122B	31024B 31124B	
34020B 34120B	34022B 34122B	34024B 34124B	34026B 34126B	31012B 31112B	31014B 31114B	31016B 31116B	31018B 31118B	31020B 31120B	31022B 31122B	31024B 31124B	
34020B 34120B	34022B 34122B	34024B 34124B	34026B 34126B	31012B 31112B	31014B 31114B	80° only	80° only	80° only			
34020B 34120B	34022B 34122B	34024B 34124B	34026B 34126B	31012B 31112B	31014B 31114B	80° only	80° only	80° only			
34020B 34120B	34022B 34122B	34024B 34124B	34026B 34126B	31012B 31112B	31014B 31114B	31016B 31116B	31018B 31118B	31020B 31120B	31022B 31122B	80° only	
34020B 34120B	34022B 34122B	34024B 34124B	34026B 34126B	31012B 31112B	31014B 31114B	31016B 31116B	31018B 31118B	31020B 31120B	31022B 31122B	80° only	
34020B 34120B	34022B 34122B	34024B 34124B	34026B 34126B	31012B 31112B	31014B 31114B	31016B 31116B	31018B 31118B	31020B 31120B	31022B 31122B	31024B 31124B	
34020B 34120B	34022B 34122B	34024B 34124B	34026B 34126B	31012B 31112B	31014B 31114B	31016B 31116B	31018B 31118B	31020B 31120B	31022B 31122B	31024B 31124B	
34020B 34120B	34022B 34122B	34024B 34124B	34026B 34126B	31012B 31112B	31014B 31114B	31016B 31116B					
34020B 34120B	34022B 34122B	34024B 34124B	34026B 34126B	31012B 31112B	31014B 31114B	31016B 31116B	31018B 31118B	31020B 31120B			
34020B 34120B	34022B 34122B	34024B 34124B	34026B 34126B	31012B 31112B	31014B 31114B	31016B 31116B	31018B 31118B	31020B 31120B	31022B 31122B	31024B 31124B	
34020B 34120B	34022B 34122B	34024B 34124B	34026B 34126B	31012B 31112B	31014B 31114B	31016B 31116B	31018B 31118B	31020B 31120B			
34020B 34120B	34022B 34122B	34024B 34124B	34026B 34126B	31012B 31112B	31014B 31114B	31016B 31116B	31018B 31118B	31020B 31120B	31022B 31122B	31024B 31124B	
34020B 34120B	34022B 34122B	34024B 34124B	34026B 34126B	31012B 31112B	31014B 31114B	31016B 31116B	31018B 31118B	31020B 31120B			
34020B 34120B	34022B 34122B	34024B 34124B	34026B 34126B	31012B 31112B	31014B 31114B	31016B 31116B	31018B 31118B	31020B 31120B	31022B 31122B	31024B 31124B	

Premier Plus Stainless Steel Wiper Blades

- All stainless steel construction
- Marine grade silicone squeegee
- Extra squeegee "claws" spread pressure evenly allowing the blade to conform to a curved windshield



Length	Color	Material	Part #	OEM #
26"	stainless	stainless	33026S	33126S
28"	stainless	stainless	33028S	—
30"	stainless	stainless	33030S	—

Note: For use only with Premier Plus Wiper Arms and Heavy Duty Plus 3.0 Motor

Deluxe Stainless Steel Wiper Blades **NEW**

- Works well on curved or flat windshields
- All stainless steel construction
- Marine grade silicone squeegee



Length	Color	Material	Part #	OEM #
12"	stainless	stainless	34012S	34112S
14"	stainless	stainless	34014S	34114S
16"	stainless	stainless	34016S	34116S
18"	stainless	stainless	34018S	34118S

Length	Color	Material	Part #	OEM #
20"	stainless	stainless	34020S	34120S
22"	stainless	stainless	34022S	34122S
24"	stainless	stainless	34024S	34124S
26"	stainless	stainless	34026S	34126S



Length	Color	Material	Part #	OEM #
12"	black	stainless	34012B	34112B
14"	black	stainless	34014B	34114B
16"	black	stainless	34016B	34116B
18"	black	stainless	34018B	34118B

Length	Color	Material	Part #	OEM #
20"	black	stainless	34020B	34120B
22"	black	stainless	34022B	34122B
24"	black	stainless	34024B	34124B
26"	black	stainless	34026B	34126B

Polymer Wiper Blades

- Black glass poly-impregnated construction
- Marine grade rubber squeegee



Length	Color	Material	Part #	OEM #
12"	black	polymer	31012B	31112B
14"	black	polymer	31014B	31114B
16"	black	polymer	31016B	31116B
18"	black	polymer	31018B	31118B

Length	Color	Material	Part #	OEM #
20"	black	polymer	31020B	31120B
22"	black	polymer	31022B	31122B
24"	black	polymer	31024B	31124B

Classic Stainless Steel Straight Wiper Blades

- Replaces most standard blades in boats made before 1990
- Hook and catch style



Length	Color	Material	Part #	OEM #
11"	stainless	stainless	33901	—
14"	stainless	stainless	33919	—

Note: NOT for use with currently offered arms

Add-On Windshield Washer Kits

- Can be used on new or existing Deluxe wiper arm and blade sets
- Kit includes parts to outfit two wiper arms
- Sprayer fittings (kit includes two) each have four adjustable brass nozzles to provide maximum spray coverage for most any windshield
- Plastic parts are numbered to make installation easy

Complete Kit

Includes:

- Water tank with mounting bracket
- 12 volt pump motor
- Under deck tee fitting
- Thru deck fitting and hardware
- Below deck clear tubing (16 ft.)
- Above deck black tubing (6 ft.)
- Large and small rivet clips
- Wiper arm clips
- Sprayer fittings with clamps

Part # 33505

OEM # 33515

Below Deck Kit

Includes:

- Water tank with mounting bracket
- 12 volt pump motor
- Under deck tee fitting
- Thru deck fitting and hardware
- Below deck clear tubing (16 ft.)

OEM # 33513

Above Deck Kit for One Small Arm

Includes:

- Small rivet clip
- Wiper arm clips
- Sprayer fitting with narrow clamp
- Thru deck fitting
- Above deck black tubing (6 ft.)

OEM # 33517



Intelligent Wiper Switch

Microcontroller based “intelligent” switch provides all necessary wiper motor functions in one small component.

- Settings for two continuous speed functions and three intermittent speed functions (2, 4, or 8 second delay)
- Washer system operation function
- Blinking LED lights in switch indicate operating function
- Works with 12V or 24V DC motors
- Fits standard switch size openings, requires 2.65”/67.5 mm depth
- Includes one ten pole connector with female pins and two female quick-connects

Single Motor

Part # 76030

OEM # 76130



Intermittent Wiper Motor Controller NEW

- Single speed and dual speed options
- Allows for the control of single motor systems, and synchronized control of dual motor systems
- Intuitive automotive-style functionality—features adjustable intermittent settings, adjustable continuous settings, and washer system operation
- IP67—Potted case for harsh environment durability
- Includes Contura Switch, SPDT (On)-Off-(On) (retail only)
- Easy to install with ¼” spade connectors
- Reverse polarity protection
- Compatible with 12V and 24V DC motors

Single Speed Part # 76090 OEM # 76190

Dual Speed Part # 76080 OEM # 76180



76080

HORNS

Hidden Horns

79



Marinco, the inventor of the first below-deck horn offers a complete line of below deck horn products.

Compact Horns

82



Marinco compact electric horns feature a low profile design and a lower frequency which provides a deeper sound.



HORNS

Electric Trumpet Horns

84



Classic design electric trumpet horns feature a lower frequency which provides a deeper sound.

Air Trumpet Horns

85



Classic design, featuring solid brass construction with a non-corrosive LEXAN polycarbonate diaphragm.



Marinco® Horns

Marinco® is the leading supplier of horns to the marine industry, with over fifty years of experience in designing and manufacturing sound devices specifically for use in harsh marine environments. Stainless steel is used for all critical components such as trumpets, motor cover, diaphragms, and assembly and mounting hardware. In the case of the XLP trumpet horns, the horn is given extra protection through the complete over-molding of the internal motor cover housing. It is this extra process that provides the added protection needed to back up the five-year warranty.

Marinco® offers a complete line of marine horn products designed to meet almost any need, including electric and air trumpet horns, compact horns, electric and air below deck horns, and a comprehensive line of drop-in horns with a wide assortment of grill options. After developing the first below deck horn for the marine industry in the late 1980's, the offering of that product line has continued to expand.

- Meets the ABYC Regulation #A23 for boats up to 12 meters
- Meets the U.S. Coast Guard's C.O.L.R.E.G.S. and U.S. Inland Navigation Rules, Annex III Regulations for boats up to 20 meters
- Listed in the NMMA's Certification Program Type Accepted
- Horns are set at a lower frequency to provide greater range as the sound travels across the water

Marinco® Horn Relative Loudness Comparison Chart

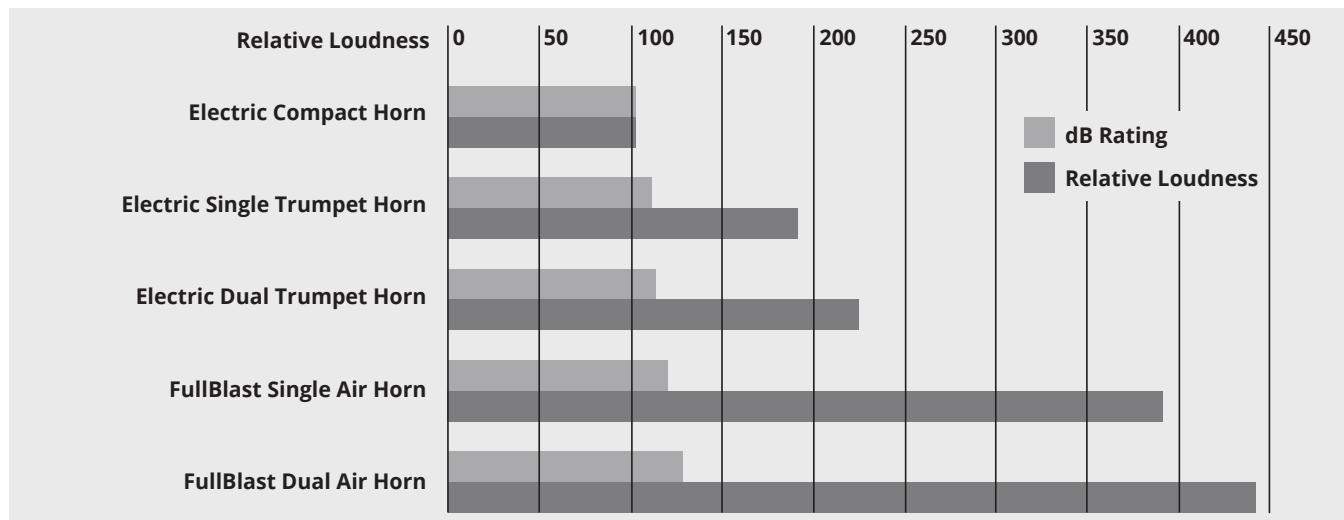

TECH tip

Electromagnetic Interference Explained

In order to operate, an electric horn rapidly makes and breaks an electric circuit. This operation creates electromagnetic disturbance, which may cause electrical "noise" in communications equipment. Because a horn is only used temporarily, any interference in electronic equipment is stopped when the horn is turned off.

The International Marine Certification Institute (IMCI), which certifies boats to the European Community Regulations (CE), has determined that boats using electric horns can comply with CE requirements on electromagnetic compatibility provided the above message is given to the boat owners in their manual.

Marinco®, the inventor of the first below deck horns, offers a full line of below deck horn products. Concealed horns utilize an upright horn installation and a large grill opening to offer greater sound volume. Drop-in Hidden Horns use a fabric lined grill for water-resistant installations. The concealed trumpet horns are all air horns and provide the maximum amount of sound available in a below deck horn installation.

Marinco's Drop-in Hidden Horns combine a number of desired features into one unit including:

- Simple, drop-in installation
- Stylish snap-on grill with water-resistant fabric
- Authentic marine sound
- Easy aftermarket retrofit

Important: Please note the space requirement dimensions on some of the below deck models to ensure there is adequate room on the interior of the mounting area to house the horn assembly. Concealed horn models require a minimum 45° mounting angle to ensure proper drainage.

Low Profile Hidden Horn

With Black and White Grills

- New louder dB(A) rating: 111 at one meter
- Fundamental frequency: 360±20Hz
- 12V DC
- Easy installation: 2.75" diameter hole x 1" deep
- Maximum amp draw: 4 amps
- Comes with both white ASA and black ABS screw-in grills
- Grills have water resistant fabric liners
- Mounts from the outside, grill screws on for easy install
- Easy retrofit

Part # 10080

Without Grill

- Same as 10080 without grill
- When purchasing bulk version, grill must be ordered separately

OEM # 11080



((Lower Frequency))
for a Deeper Sound))



Grills for Low Profile Hidden Horn

- Water resistant fabric liner
- Screw-in
- 4" from hole to hole

Type	Color	Vertical Style OEM #	Horizontal Style OEM #	Dimensions
Screw-in	White ASA	11080SC-W	11187	5.25" x 3.375" x .75"
	Off-White ASA	—	11194	5.25" x 3.375" x .75"
	Black ABS	11080SC-B	11188	5.25" x 3.375" x .75"
	Stainless Steel	11080SC-SS	—	5.25" x 3.375" x .75"



Vertical Style ASA/ABS

Vertical Style Stainless Steel



Horizontal Style



Stainless Steel Grill Cover

- Horizontal style grill design
- Installs over plastic horizontal style grills (11187, 11194, or 11188)
- Installation requires plastic grill
- Grill dimensions: 5.3125" W x 3.4375" H x .875" D

OEM # 11196 Stainless steel grill

OEM # 11096 Kit (includes: stainless steel grill cover and plastic screw-in grill (11187))

Drop-in Hidden Horns

With Black and White Grills

- dB(A) rating: 107 at one meter
- Fundamental frequency: 370±20Hz
- 12V DC
- Internal space requirements: 2" H x 3.375" W x 3.25" D
- Maximum amp draw: 4 amps
- Comes with both black ABS and white ASA snap-in grills
- Distinctive marine horn sound
- Enclosed sound unit
- Easy installation or retrofit, mounts from the outside

Part # 10079

Enclosed without Grill

- Same as 10079 without grill
- When purchasing 11079, grill must be ordered separately

OEM # 11079



Without Grill

- dB(A) rating: 105 at one meter
- Fundamental frequency: 430±20Hz
- 12V DC
- Internal space requirements: 2.25" H x 3.625" W x 3.5" D
- Maximum amp draw: 3 amps
- Mounts from the outside, horn grill snaps on for easy installation
- Easy retrofit
- Grill must be ordered separately

OEM # 11095

((Lower Frequency))
for a Deeper Sound))



Grills for Drop-in Hidden Horns

- Water resistant fabric liner
- Choose between snap-in or screw-in.
- 4" from hole to hole

Type	Color	Vertical Style OEM #	Horizontal Style OEM #	Dimensions
Snap-In	White ASA	11079SN-W	11090	5" x 2.625" x .5"
	Black ABS	11079SN-B	11091	5" x 2.625" x .5"
	Chrome Plated ABS	11079SN-C	11225	5" x 2.625" x .5"
Screw-In	White ASA	11079SC-W	11190	5" x 2.625" x .5"
	Black ABS	11079SC-B	11191	5" x 2.625" x .5"
	Chrome Plated ABS	11079SC-C	11226	5" x 2.625" x .5"
	Stainless Steel	11079SC-SS	—	5" x 2.625" x .5"



Stainless Steel Grill Cover

- Installs over screw-in plastic grill
- Requires plastic screw-in grill for installation
- Grill dimensions: 5.0625 W x 2.75 H x .5 D

OEM # 11124 Stainless steel grill

OEM # 11024 Kit (includes: stainless steel grill cover and plastic screw-in grill)



Under Deck Horn

- dB(A) rating: 110 at one meter
- Fundamental frequency: 420±20Hz
- 12V DC
- Dimensions: 4" W x 3.625" H x 5.75" L
- Permanently mounted grill to protect against water intrusion
- Available with and without wiring pigtail

OEM # 11044 Horn with Pigtail
 OEM # 11045 Horn without Pigtail

((Lower Frequency))
 for a Deeper Sound



Mini Hidden Horn

- dB(A) rating: 105 at one meter
- Fundamental frequency: 430±20Hz
- 12V DC
- Dimensions: 3.25" W x 1.75" H x 3" L
- Maximum amp draw: 3 amps
- Type 304 stainless steel diaphragm
- This horn is not designed for installation in exposed areas

Part # 10031
 OEM # 11031

((Lower Frequency))
 for a Deeper Sound



With Grill Bracket

- Same horn motor as 11031 but includes grill mounting bracket
- Grill must be ordered separately

OEM # 11034



Grills for Mini Hidden Horn 11034

- Screw-In
- Black ABS version includes gasket for watertight seal
- 4" from hole to hole

Type	Color	Vertical Style OEM #	Horizontal Style OEM #	Dimensions
Screw-In	Black ABS	11034SC-B	11168	5" x 2.625" x .375"
	Stainless Steel	11034SC-SS	11088	5" x 2" x .25"



Vertical Style
ASA/ABS



Vertical Style
Stainless Steel



Horizontal
Style



Electronic Horn

With White Grill

- 107 dB(A) at one meter
- Fundamental frequency: 550±100Hz
- 12V DC
- Internal space requirements: 2.25" W x 2.25" H x 2" D
- Grill dimensions: 4.875" W x 2.75" H x .5"D
- Draws less than one amp, maximum draw: 0.8 amp
- Electronic piezo horn sound
- One piece water resistant housing, grill is molded to horn
- Mounts in a standard 2.25" opening
- Stainless steel grill cover 11185 sold separately

Part # 10082

Stainless Steel Grill Cover for Electronic Horn 10082

- Grill dimensions: 4.9375" W x 2.8125" H x .5" D
- 4" from hole to hole

OEM # 11185



Concealed Single Mini Air Horn

- dB rating: 126 at one meter, 1/3 octave band
- Fundamental frequency: 630±15Hz
- 12V DC
- Internal space requirements: 13" H x 5" W x 3.75" D
- Air compressor dimensions: 2.625" D x 5" L
- Maximum amp draw: 20 amps
- Solid brass construction
- Includes compressor, air tubing, fittings, and hardware
- Grill must be ordered separately

OEM # 11059

Stainless Steel Grill for 11059

- Dimensions: 4.6875" H x 4.6875" W

OEM # 11064



Concealed Dual Trumpet Air Horn

- dB rating: 121 at one meter, 1/3 octave band
- Fundamental frequency: 375±15/315±15Hz
- 12V DC
- Internal space requirements: 10" W x 18.5" H x 3.75" D
- Air compressor dimensions: 5" L x 2.625" D
- Maximum amp draw: 20 amps
- Solid brass construction
- Can be mounted side by side with dual grill 11066 or separately with two single grills 11064
- Includes compressor, air tubing, fittings, and hardware

OEM # 11058

Stainless Steel Grill for 11058

- Dimensions: 9.375" W x 4.6875" H

OEM # 11066



MiniBlast™ Compact Electric Horns

- dB(A) rating: 106 at one meter (3 feet)
- Fundamental frequency: 430±20Hz
- 12V DC
- Dimensions: 4.375" L x 3.375" W x 2" H
- Maximum amp draw: 3 amps
- Long lasting, non-corrosive ASA plastic cover
- Sealed sound unit with stainless steel diaphragm
- Mounts in same hole pattern as the 10035 horn

White Part # 10099 OEM # 11099
 Black Part # 10098 OEM # 11098



Mini Compact Electric Horn

- dB(A) rating: 106 at one meter
- Fundamental frequency: 430±20Hz
- 12V DC
- Dimensions: 3" L x 3.25" W x 1.75" H
- Maximum amp draw: 3 amps
- Totally sealed sound unit
- Type 304 stainless steel cover, diaphragm, mounting bracket

Part # 10035
 OEM # 11035



Mini Twin Electric Horn

- dB(A) rating: 109 at one meter
- Fundamental frequency: 490±20/430±20Hz
- 12V DC
- Dimensions: 3" L x 8" W x 1.75" H
- Maximum amp draw: 6 amps
- Type 304 stainless steel covers, diaphragms, and mounting bracket

Part # 10001
 OEM # 11001



International Shorty Horn

- dB(A) rating: 123 at one meter
- Fundamental frequency: 310±20 Hz
- 12V DC
- Dimensions: 4.25" L x 5" W x 6.5" H
- Maximum amp draw: 4 Amps
- Stainless steel diaphragm and mounting bracket
- ABS, triple chrome-plated housing

Part # 10036



Single Trumpet Electric Horn

- dB(A) rating: 118 at one meter
- Fundamental frequency: 370±20Hz
- Dimensions: 16.5" L x 4" W x 4.75" H
- Maximum amp draw: 5 amps
- 100% stainless steel exterior
- Type 304 stainless steel diaphragm

Premium XLP

12V Part # 10028XLP OEM # 11028XLP
 24V Part # 10017XL OEM # 11017XLP Max amp draw: 2.5 amps

5 YEAR WARRANTY



((Lower Frequency))
 for a Deeper Sound))

Dual Trumpet Electric Horn

- dB(A) rating: 123 at one meter
- Fundamental frequency: 370±20/310±20Hz
- Dimensions: 18.5" L x 8" W x 5" H
- Maximum amp draw: 10 amps
- 100% stainless steel exterior
- Type 304 stainless steel diaphragm

Premium XLP

12V Part # 10029XLP OEM # 11029XLP
 24V Part # 10018XL OEM # 11018XLP Max amp draw: 5 amps

5 YEAR WARRANTY



Compact Single Trumpet Electric Horn

- dB(A) rating: 110 at one meter
- Fundamental frequency: 420±20Hz
- 12V DC
- Dimensions: 14" L x 3.5" W x 4" H
- Maximum amp draw: 3.5 amps
- Compact design makes it easier to install in smaller spaces
- 100% stainless steel exterior
- Type 304 stainless steel diaphragm

Part # 10010



((Lower Frequency))
 for a Deeper Sound))

Compact Dual Trumpet Electric Horn

- dB(A) rating: 115 at one meter
- Fundamental frequency: 420±20/370±20Hz
- 12V DC
- Dimensions: 16" L x 7.5" W x 4" H
- Maximum amp draw: 7 amps
- Compact design makes it easier to install in smaller spaces
- 100% stainless steel exterior
- Type 304 stainless steel diaphragm

Part # 10011



All of our air horns produce sound levels ranging between 120dB and 127dB, which means all of our air horns meet the ABYC and NMMA regulations for boats up to 20 meters/66 feet. Both 12V and 24V compressors are CE listed.

Single Trumpet Mini Air Horns

- dB rating: 126 at one meter, 1/3 octave band
- Fundamental frequency: 630±15Hz
- Dimensions: 9.5" L x 3.5" W x 3.5" H
- Maximum amp draw: 20 amps (12V DC)
- Solid brass construction with non-corrosive LEXAN® polycarbonate diaphragm
- Includes compressor, air tubing, fittings, and hardware

Chrome Plated **Part # 10107** **OEM # 11107**
 White Epoxy Coated **Part # 10104** **OEM # 11114**



Air Compressor included

Dual Trumpet Mini Air Horns

- dB(A) rating: 127 at one meter, 1/3 octave band
- Fundamental frequency: 630±15/525±15Hz
- Dimensions: 9.5" L x 5" W x 3.75" H
- Maximum amp draw: 20 amps (12V DC)
- Solid brass construction with non-corrosive LEXAN® polycarbonate diaphragm
- Includes compressor, air tubing, fittings, and hardware

Chrome Plated **Part # 10108**



Air Compressor included

Single Trumpet Air Horns

- dB rating: 120 at one meter, 1/3 octave band
- Fundamental frequency: 315±15Hz
- Dimensions: 17" L x 3.75" W x 3.75" H
- Maximum amp draw: 20 amps (12V DC), 10 amps (24V DC)
- Solid brass construction with non-corrosive LEXAN® polycarbonate diaphragm
- Includes compressor, air tubing, fittings, and hardware

12 Volt **Part # 10105** **OEM # 11115**
 24 Volt **Part # 10524**



Air Compressor included

Dual Trumpet Air Horns

- dB rating: 121 at one meter, 1/3 octave band
- Fundamental frequency: 375±15/315±15Hz
- Dimensions: 17" L x 7" W x 3.75" H
- Maximum amp draw: 20 amps (12V DC), 10 amps (24V DC)
- Solid brass construction with non-corrosive LEXAN® polycarbonate diaphragm
- Includes compressor, air tubing, fittings, and hardware

12V Chrome Plated **Part # 10106** **OEM # 11106**
 12V White Epoxy Coated **Part # 10122**
 24V Chrome Plated **Part # 10624**
 24V White Epoxy Coated **Part # 12224** **OEM # 22224**



Air Compressor included

Air Compressor

- Replacement compressor fits all Marinco® and AFI™ Air Horns
- Maximum amp draw: 20 amps (12V DC), 10 amps (24V DC)
- Produces 9–11 PSI
- Dimensions: 2.625" D x 5" L
- Includes mounting bracket

12V **OEM # 10102**
 24V **OEM # 10224**



LEXAN® is a registered trademark of Sabic Innovative Plastics IP B.V., Netherlands

LIGHTING

Precision Wireless Controlled Spotlight

88



Controlled by wireless remote control. Provides 370 degree sweep and 120 degree tilt. Designed for harsh marine environments, it is moisture, salt, and vibration resistant.

IP67 Stainless Steel Spot/Floodlight

89



Wireless remote communication. Stainless steel construction.

5" Stainless Steel Spot/Floodlight

90



Remote control / joystick operated stainless steel construction.



LIGHTING

IP67 Stainless Steel Spot/Floodlight

89

NEW



Features a 7", 12 LED array, and IP67 stainless construction. Creates approx. 3 times concentrated spot diameter while drawing roughly half the power of comparable halogen spotlights. Wireless communication using mounted bridge or hand held remote.

Deck Lamps

91



State-of-the-art free form lens reflector technology allows for 30% more light output than comparable 55W lamps.

Docking Lights

91



Compact flush mount docking lights for a variety of applications.



Proper lighting is necessary for safety and operational activities aboard vessels.



Precision Wireless Controlled Spotlight

- Universal 12/24 volt circuit with bright 100W, H3 halogen bulb
- UV resistant, IP56 Weatherproof ABS housing and Lexan® lens
- O-ring sealed housing, designed for the harsh marine environment – moisture, salt, shock and vibration tested
- Universal snap-in mounting system (can be mounted upside down)
- Super-quiet, all-weather motor with limit stops provides a full range of coverage
- 370° sweep and 120° tilt (75° up and 45° down)
- One touch auto sweep and S.O.S. function
- Wireless dash mount remote standard; (hard wired & handheld remotes are optional)
- 3-Year limited warranty
- Available in white, black and chrome

3 YEAR WARRANTY

Bulb:	100 Watt, H3 Halogen
Power (Input voltage):	12V or 24V
Current draw (idle/in use):	0.03 amps / 7.0 amps
Peak Beam Intensity:	210,000 Cp
Peak Beam Distance:	917 ft (280 m)
Lux @ 66' (20 m):	525 Lux
Coverage at 66' (20 m):	132 sq ft (12 sq m)
Rotation:	370° (built in limit stops)
Tilt:	120° Tilt (75° up & 45° down)
Wireless range:	200 ft (65 m)
Dimensions:	7.5"W x 7.5"H x 9.25"D (19 x 19 x 23.5 cm)
Weight:	3.30 lbs (1.5 kg)
Housing material:	UV resistant PC/ASA
Lens material:	UV resistant Lexan®
operating temp range:	5°F-113°F (-15°C-45°C)
IP Rating:	IP56



Spotlights

Description	Color	Part #	OEM #
12/24 Volt, 100 Watt	white	SPL-12W	—
12/24 Volt, 100 Watt	black	SPL-12B	—
12/24 Volt, 100 Watt	chrome	SPL-12C	—
12 Volt, 100 Watt	white	—	SPL-12W.OEM
12 Volt, 100 Watt	black	—	SPL-12B.OEM
12 Volt, 100 Watt	chrome	—	SPL-12C.OEM
24 Volt, 100 Watt	white	—	SPL-24W.OEM
24 Volt, 100 Watt	black	—	SPL-24B.OEM
24 Volt, 100 Watt	chrome	—	SPL-24C.OEM

Replacement Bulbs

Description	Part #
12 Volt, H3 Halogen	202319
24 Volt, H3 Halogen	202320



Remote Options

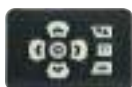

SPLR-2

Included



SPLR-1

(optional)



SPLR-3

(optional)

	SPLR-2 Included	SPLR-1 (optional)	SPLR-3 (optional)
Remote Specifications	Wireless Communication Bridge Remote	Hand Held Bridge Remote	Wired Bridge Remote
Power	12 or 24 volt (hard wired)	CR2450 button cell battery	12 or 24 volt (hard wired)
Current draw (idle / in use)	negligible	negligible	negligible
Wireless range	200 ft (65m)	200 ft (65m)	—
Estimated battery life	—	> 40 hours (continuous use)	—
Dimensions	3.5"W x 2.25"H x .75"D 88 x 57 x 19 mm	2.0"W x 3.78"H x 1"D 51 x 96 x 25 mm	3.5"W x 2.25"H x .75"D 88 x 57 x 19 mm
Weight	2.12 oz (60g)	2.82 oz (80g)	2.12 oz (60g)
Housing material	UV resistant PC/ASA	UV resistant PC/ASA	UV resistant PC/ASA
Button material	Silicone (glow in the dark)	Silicone (glow in the dark)	Silicone (glow in the dark)
Operating temp range	5°F-113°F (-15°C-45°C)	5°F-113°F (-15°C-45°C)	5°F-113°F (-15°C-45°C)
IP Rating	IP54	IP56	IP54

IP67 Halogen Stainless Steel Spot/Floodlight

- Wireless remote communication
- 316 stainless steel base, 304 stainless steel head
- 350° horizontal, 60° vertical two speed movement

Peak beam intensity	165,000 CP spot
Amp draw	Spot 8.3A, flood 7.5A @ 12V Spot 4.15A, flood 3.75A @ 24V
Power (Input voltage)	12V & 24V
Bulb	H4 halogen
Dimensions	9.875"H x 4.75"W x 8.35"L
Weight	6 lbs.
IP Rating	IP67

Description	Part #
12V Spot/Flood with Remote (22250-R)	22050A
12V Spot/Flood Only	22051A
24V Spot/Flood with Remote (22350-R)	22150A
24V Spot/Flood Only	22151A



3 YEAR WARRANTY

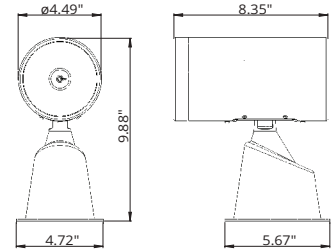

Remote Options



22250-R 12V



22350-R 24V

22250-HH 12/24V

Remote Specifications	Wireless Communication Bridge Remote	Hand Held Bridge Remote
Power	12V DC 24V DC	Battery: L1028F Alkaline 12V
Wireless range	100 ft (30m)	100 ft (30m)
Dimensions	2.2"W x 3.65"H x 0.9"D	2.25"W x 3.95"H x 1.2"D
Housing material	ASA	ASA
Button material	Silicone (glow in the dark)	Silicone (glow in the dark)

IP67 LED Stainless Steel Spotlight **NEW**

- Wireless remote communication
- 316 stainless steel base, 304 stainless steel head
- 350° horizontal, 60° vertical two speed movement

Light Output	92,000 CD
Amp Draw	3A @ 12V DC 1.5A @ 24V DC
Power (Input voltage)	12V or 24V DC
# of LEDs	12
Dimensions	9.875"H x 4.75"W x 8.35"L
Weight	11.36 lbs
IP Rating	IP67

Description	Part #
12V Spotlight with Remote (23250-R)	23050A
12V Spotlight Only	23051A
24V Spotlight with Remote (23350-R)	23150A
24V Spotlight Only	23151A



3 YEAR WARRANTY

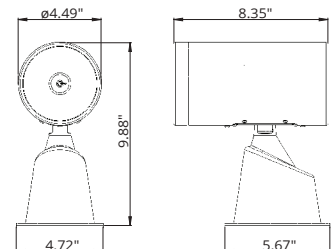

Remote Options



23250-R 12V



23350-R 24V

23250-HH

Remote Specifications	Wireless Communication Bridge Remote	Hand Held Bridge Remote
Power	12V DC 24V DC	Battery: L1028F Alkaline 12V
Wireless range	100 ft (30m)	100 ft (30m)
Dimensions	2.2"W x 3.65"H x 0.9"D	2.25"W x 3.95"H x 1.2"D
Housing material	ASA	ASA
Button material	Silicone (glow in the dark)	Silicone (glow in the dark)

5" Stainless Steel Spot/Floodlight

- Remote control, joystick operation
- 316 stainless steel base, 304 stainless steel head
- Dual station option available
- Light can be directed manually without damaging motors
- One year warranty

Part # 22040A	Spot/Flood Kit
Part # 22041A	Spot/Flood Only

Spot Power:	72,000 CP
Flood Power:	30,000 CP
Amp Draw:	7 amps
Operation:	12V Incandescent
Bulb:	Replaceable Incandescent
Lamp Dimensions:	9.5" H x 4.5" W x 7.5" L
Base Dimensions:	5.5" L x 3.5" W
Weight:	6 Lbs.
Joystick requires:	2.75" installation hole



Replacement Bulb

- 12V Incandescent

Part # 22014-P

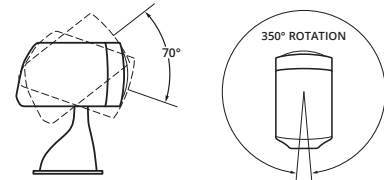

Spotlight Parts & Accessories

Stainless Steel Spot/Flood Parts and Accessories

Part #	Oval Panel	Rectangular Control	Dual Station Control Kit	Replacement Bulb Kit
22040A	22240-R	22208A	22218A	22014-P
22041A	22240-R	22208A	22218A	22014-P

Beamer™ Parts and Accessories

Part #	Control Panel	Dual Station Control Kit	Replacement Bulb Kit	Extension Cable Kit	Wires in Cable
500, 500A	729823-P	729823-P	729493	—	1
501, 501A	729825	729825	729493	—	Wireless
502, 502A	729827-P	729828-P	729493	729528	5
502-1	U-3605	729488	729493	729528	5
502-2	729489	729489	729493	729528	5
503, 503A	729829-P	729830-P	729494	729528	6
503-1	U-3606	729491	729494	729528	6
503-2	—	729492	729494	729528	6



M100 Remote Halogen Spot Parts and Accessories

Part #	Joystick Control	Dual Station Control Kit	Replacement Bulb Kit
22200	22209	22219A	22230-P
22201	22209	22219A	22230-P

Cables

Length	Replacement Male to Male	Extension Male to Female
25 Ft.	22011A-P	—
35 Ft.	22012A-P	22012MA-P

Use with: 22040A, 22041A, 22044, 22045, 22200 or 22201 Lights



Universal Halogen Deck Lamps

State-of-the-art free form lens reflector technology allows for 30% more light output than comparable 55W lamps. Universal mounting brackets and compact size make for easy installation anywhere. Lamp housing is made of UV stabilized plastic and all hardware is 316 chrome plated stainless steel. Includes 12V, 55W halogen bulb and is 24V, 70W compatible.

Bulbs:	Replaceable H3 12V 55W/H3 24V 70W
Dimensions:	3.75" H x 3.375" W x 5.5" L
Mounting Height:	4" with bracket

- Part # **ML-005BW/DSP** OEM # **ML-005BW-STC** Black
- Part # **ML-005WW/DSP** OEM # **ML-005WW-STC** White



Flush Mount Deck Lamp

In addition to our highly popular conventional halogen deck lamps, we now offer a flush mount version. Ideally suited for fiberglass hardtop installations and allows for a very clean and finished installation. Free Form lens reflector technology guarantees maximum output. Lamp is completely waterproof and constructed of impact resistant UV stable plastic. Comes complete with 12V 55W halogen H3 bulb. Also suitable for 24V 70W bulbs.

Bulbs:	Replaceable H3 12V 55W/H3 24V 70W
Dimensions:	3.375" H x 1.5" W x 5.625" L
Cutout:	3" hole

- Part # **ML-005NWW**



Flush Mount Docking Lights—Convex Lens

Compact flush mount docking lights for a variety of applications. Easy to install through a 2" hole. Ideal for Pontoon and Deck boat docking lamps, spreader lamps or rear docking lamps for motor homes. Features a high performance convex lens with a 12V 37.5W halogen bulb for optimum performance. Available with and without stainless steel frame. Pigtail required.

Bulbs:	Replaceable #893 12V 37.5W Halogen
Dimensions:	ø = 2-1/2" Frame thickness: 7/8" Overall depth: 2-7/8" Mounting depth: 2"
Mounting Depth:	2"

- Part # **M051B** With out frame
- Part # **M051B-SS** Stainless frame
- Part # **11-004-N** Pigtail for M051B and M051B-SS



Flush Mount Docking Lights—Flat Lens

Compact flush mount docking lights for a variety of applications. Easy to install through a 2" hole. Ideal for Pontoon and Deck boat docking lamps, spreader lamps or rear docking lamps for motor homes. Features a high performance free form reflector with a 12V 35W halogen bulb for optimum performance. Available with and without stainless steel frame.

Bulbs:	Replaceable MR16 12V 35W Halogen
Dimensions:	ø = 2-1/2" Frame thickness: 7/8" Overall depth: 2-7/8" Mounting depth: 2"
Mounting Depth:	2"

- Part # **M051A** With out frame
- Part # **M051A-SS** Stainless frame

Slim Line Docking Light

This slim line docking lamp was specifically designed for flush mount installations on Pontoon boats. Includes low profile, stainless steel mounting bracket and 12V 35W halogen H3 bulb.

Bulbs:	Replaceable H3 12V 35W
Dimensions:	6-7/8" x 2-3/8" x 1-1/2"
Mounting Height:	2-1/4" with bracket



- Part # **WJ-B2005-A-35W**

VENTILATION

Day/Night Solar Vent

96

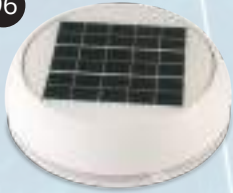

Day/Night solar vents offer 24 hour ventilation in a compact footprint. The new design can be removed from the deck and features LED lights and additional controls that are accessed from the cabin.

Mini Vent 1000

97



The MiniVent 1000 is the smallest and most economical solar vent in the Marinc® line. At just 7" in diameter and approximately 1-3/4" high, the MiniVent 1000 is compact yet effective. This solar powered model is an exhaust vent only.

Air Vent 500 Passive Exhaust Ventilation

97

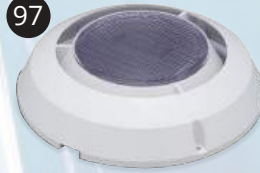

Marinc® offers the AirVent 500 as a non-solar ventilation option that can passively move 600 to 1,000 cubic feet of air per hour in a 15 knot breeze. Marinc's engineering expertise created this vent to be strong, compact and effective.



VENTILATION

Cowl Vents

98



Cowl Vents are available in both low profile and standard height contours. These vents are a perfect air intake supplement to solar ventilation, and are also commonly used as a bilge ventilating system with or without a mechanical blower.

Clam Shell Vents

99



Clam shell vents are ideal for ventilation needs where a taller vent would foul lines or restrict crew movement. These vents work well as stern mounted ventilators for engine compartments.

Deck Plates

99

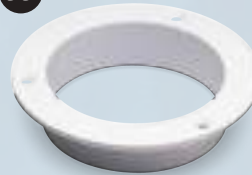

Deck plates are used to attach ventilators to the deck, hatch or hose. These plates create a clean installation and can be used with multiple material thicknesses.

Fans

100



Marinco fans provide cabin comfort by direct wiring into a 12V DC system. Multiple models are available to accommodate different installations.

Properly ventilated vessels provide for a more comfortable environment aboard and eliminates the accumulation of dangerous fumes.

TECH tip

Ventilation Explained

Maintenance Ventilation

In most climates, boats that have been closed for a period of time will become "stuffy." The temperature differential that develops between the boat cabin and the outdoor environment will cause the humidity level inside the boat cabin to rise. When the humidity level in the closed cabin rises, moisture forms, resulting in mold, mildew and musty air. In these conditions, fabrics, boat electronics and even the boat's fiberglass structure can be damaged. By consistently replacing trapped, stale air in the closed boat with fresh outside air, the humidity equalizes from inside to outside, resulting in effective maintenance ventilation.

Comfort Ventilation

Combining different types of vents, with one vent providing "intake" air flow while another vent provides "exhaust" air flow, creates cross-flow ventilation. A cross-flow ventilation system will make the interior cabin more comfortable and pleasurable because air is constantly moving throughout the cabin. No matter what your boat size or cabin configuration is, you can increase your boating enjoyment with the addition of ventilation.

Safety Ventilation

Most boaters are unaware of the hazards that exist in the boating environment. Any number of serious ventilation problems can occur when a boat is left unattended. And even if you are underway, these problems don't go away. Fumes and gasses, ranging from carbon monoxide to hydrogen gas from battery charging, to gasoline, propane or solvents stored below, are unpleasant, and can sometimes be dangerous. Also, any open flame devices in the cabin require proper ventilation. Ventilation helps to eliminate these hazards by providing constant air circulation resulting in effective safety ventilation.

How Much Ventilation Is Required For Your Boat?

Ideally, the air in the interior of a boat should be circulated once every hour. A typical 30-foot boat contains approximately 800 cubic feet of air. As you will see, our solar powered models can move between 600 and 1,000 cubic feet of air every hour. The general guidelines for providing maintenance ventilation are as follows:

Boat Size	Recommended Ventilation
Up to 24 ft.	1 Exhaust Vent*
24 to 40 ft.	1 Exhaust Vent & 1 Intake Vent
40 ft. and larger	2 Exhaust Vents & 1 Intake Vent

* For effective maintenance ventilation, one vent assumes there will be access for air to get into the cabin (i.e., cowl vent, clamshell vent or louvered panel)

It is important to evaluate the cabin layout of your boat to determine optimal locations for both intake and exhaust ventilation. These illustrations suggest placement for Marinco® solar powered vents and Marinco® passive vents.

Note how the placement of the vents creates cross flow ventilation.

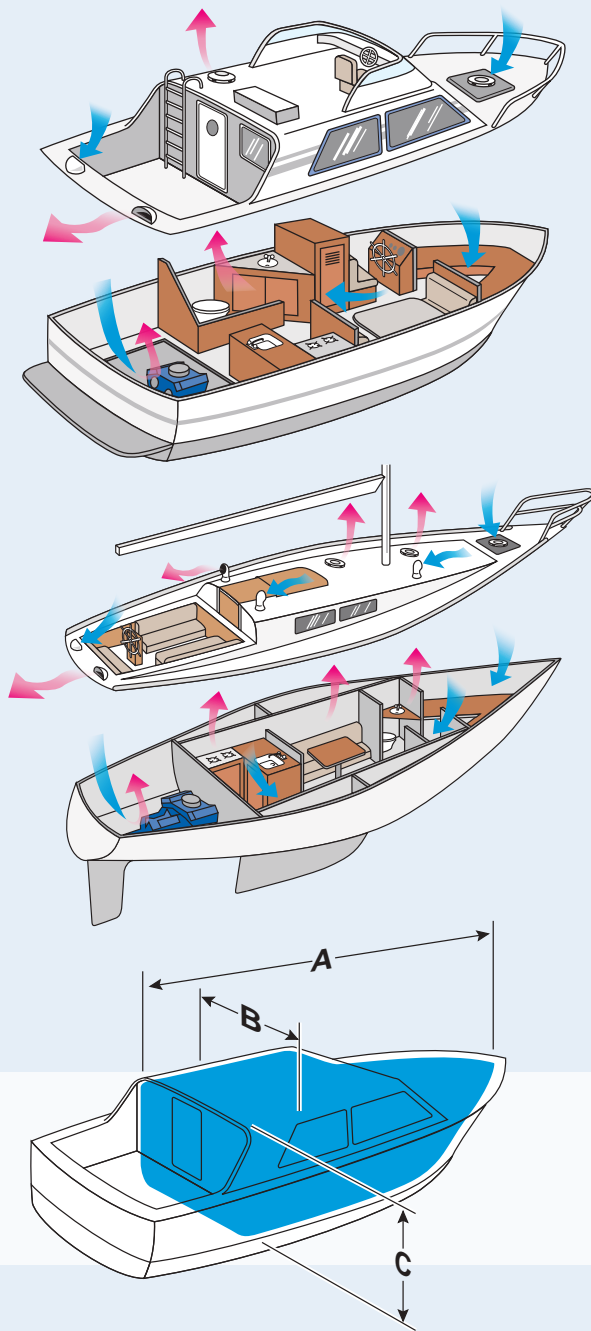

To specifically calculate your boat's air volume, use this simple formula:





























$$A \times B \times C \times 70\% = \text{Boat Interior Volume}$$

A Dimension is the interior length (excluding cockpit)

B Dimension is the boat width

C Dimension is the average interior height

Ventilation Selection Chart

	Airflow Size	Hole Size Diameter	Deck Plate	Mounting Flange Depth	Operation		Cubic Feet of Air	Intake	Exhaust
					Day	Night			
	4" / 102 mm	4-3/4"	Screw-In (6" Outer Diameter)	2.75"	 Solar	 Rechargeable Battery Power	1000 ft ³ /hour 28 m ³ 24,000 ft ³ /day 680 m ³	 Fan (switch)	 Fan
	3" / 76 mm	3-3/4"	Screw-In (5" Outer Diameter)	2.75"	 Solar	 Rechargeable Battery Power	800 ft ³ /hour 23 m ³ 19,200 ft ³ /day 550 m ³	 Fan (switch)	 Fan
	3" / 76 mm	3-3/4"	None (Direct to Deck Mounting)	1"	 Solar	 Passive	700 ft ³ /hour 20 m ³ 5,600 ft ³ /day 160 m ³	 Exhaust fan only	 Fan
	3" / 76 mm	3-3/4"	None (Direct to Deck Mounting)	1"	 Passive	 Passive	600 ft ³ /hour 17 m ³ In a 15 Knot Breeze	 Passive	 Passive
	4" / 102 mm	4-3/4"	Snap-In (6" Outer Diameter)	1"	 Passive	 Passive	—	 Passive	 Passive
	3" / 76 mm	3-3/4"	Snap-In (5" Outer Diameter)	1"	 Passive	 Passive	—	 Passive	 Passive

TECH tip™

Vent Installation Explained

Installation

All Marinco® ventilation products include clear, easy-to-understand installation instructions. These instructions address all of the key factors of a professional installation, such as:

- Proper hole measurement and cutting procedures
- Proper deck plate installation
- Use of sealants to waterproof your vent installation
- Installing vents in hatches
- Installing vents in "cambered" or slightly curved decks
- Use of interior trim rings to "dress up" the cabin

The high quality level of Marinco® Ventilation products must be combined with a sound installation to guarantee that your vent performs in all conditions. Marinco® will make sure that your installation will be easy and successful so that you can enjoy the benefits of installation for a long time to come.

Marinco® Ventilation Installation Systems

Snap-In Deck Plate Installation

The 12 volt vent, 12 volt combo vent and cowl vents use the Marinco® Snap-In deck plate system. The snap-in system allows the easy exchange of any snap-in part for upgrading or convenience, as well as the use of a snap-in cover that completely seals the deck plate making it water tight.

Direct-To-Deck Installation

The Day/Night Plus, MiniVent 1000 and AirVent 500 are designed to be installed directly to the deck without the requirement for a deck plate.

All of these vent systems have built-in shut-off dampers that operate from below.

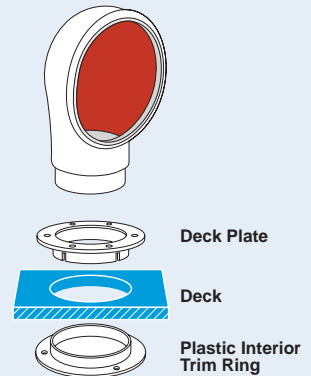

Day/Night Solar Vent

- Circulates fresh air in boat cabin eliminating mold, mildew and musty air
- Moves 1,000 cubic feet of air/hour or 24,000 cubic feet of air/day (4" model)
- Rechargeable battery allows for 24-hour continuous operation
- Whisper quiet fan operation
- No wiring required
- Built-in on/off fan switch, LED lights and intake/exhaust switch
- High capacity NiMh battery operates vent for up to 24-hours without sunlight on a full charge
- Threads into included deck plate and can be removed from outside without tools
- Complete air and green water shut-off from below
- All Day/Night Plus models come complete with white plastic interior trim ring, insect screen, mounting hardware and an easy-to-understand installation manual
- **Replaces NICRO 3" & 4" snap-in deck plates (fits existing holes once snap-in deck plates are removed)**

3" White	Part #	N20803W
3" Stainless Steel	Part #	N20803S
4" White	Part #	N20804W
4" Stainless Steel	Part #	N20804S



Replacement NiMh Battery

- High capacity battery pack
- 4.8 volts, 2.5 amp-hours
- Replacement battery pack for current Day/Night Vents

Part # N20890



Solar Vent Cap **NEW**

- Includes screw-in watertight cap

Part #	N20803CAP	for 3" vents
Part #	N20804CAP	for 4" vents



Replacement Trim Ring **NEW**

Part #	N20803RING	for 3" vents
Part #	N20804RING	for 4" vents



Original Day/Night Plus Vent Accessories

Replacement NiMh Battery

- High capacity C-cell battery
- 1.2 volts, 2.0 amp-hours
- Replacement battery for older Day/Night Plus Vents, as well as, older model PowerVent 3000 and Day/Night 2000 Vents

Part # N20790



Gasket Kit

- Includes gaskets and fasteners for both 3" and 4" vents

Part # 202432



Mini Vent 1000

The MiniVent 1000 is the smallest and most economical solar vent in the Marinco® line. At just 7" in diameter and approximately 1-3/4" high, the MiniVent 1000 is compact yet effective. This solar powered model is an exhaust vent only. It will keep the boat cabin cool when you need it most, during the hot sunlight hours. Under solar power, the Mini Vent 1000 will move 700 cubic feet of air an hour. At night, even a light breeze will continue to ventilate the boat passively.

Built-in shut-off damper prevents water intrusion in rough seas. Fits a 3-3/4" diameter installation hole. The vent can be retrofitted to an existing hole of up to 6" in diameter. Available in white ABS plastic or stainless steel. Optional stainless steel cover is also available separately.

- Solar powered exhaust ventilation during daylight and passive exhaust at night
- No batteries or wiring required
- Whisper-quiet fan operation
- Durable white ABS construction
- Shut-off damper to prevent water intrusion in rough seas
- Dimensions: 7" diameter X 1-3/4" high
- All MiniVent 1000 models come complete with white plastic interior trim ring, mounting hardware and an easy-to-understand installation manual

3" White **Part # N20020**
 3" Stainless Steel **Part # N20030**



CE
2 YEAR WARRANTY

Air Vent 500 Passive Exhaust Ventilation

Marinco® offers the AirVent 500 as a non-solar ventilation option that can passively move 600 to 1,000 cubic feet of air per hour in a 15 knot breeze. Marinco's engineering expertise created this vent to be strong, compact and effective. The AirVent 500 is an economical way to provide ventilation in your boat or it can be used in conjunction with other solar powered or 12V vents to create cross flow air circulation.

- Compact size: 7" diameter x 1-3/4" high
- High Air Flow volume 1,000 cu. ft./hour in a 15 knot breeze
- Strong U.V. stabilized white ABS construction
- Center panel is translucent plastic allowing light to pass through it below deck
- Center damper shuts vent off from below
- Easy installation – attaches directly to deck in compact 3-3/4" diameter hole and can be retrofitted to an existing hole of up to 6" in diameter

Part # N28810



2 YEAR WARRANTY

Cowl Vents

Cowl Vents are available in both low profile and standard height contours. These vents are a perfect air intake supplement to solar ventilation, and are also commonly used as a bilge ventilating system with or without a mechanical blower. Marinco® was the first supplier of soft, durable PVC vents that are flexible and safe. For interchangeability, Marinco® 4" cowl vent models fit into the same 4" Snap-In deck plates used by the Combo and 12V vents (3" or 4" sizes).

- Soft and durable PVC construction returns to original shape if stepped on
- Safer than metal cowl vents – prevents injury and resists snagging lines
- Snap-In vents include deck plate and cover
- 4" models interchangeable with Marinco® Combo and 12V Vent 4" snap-in deck plates
- Marinco® adapter accessories make installing below-deck duct hose easy

Snap-In Deluxe Low Profile PVC Cowl Vent

- White with bright red interior
- Available in 3" or 4" sizes
- 3" size measures 4-1/2" high
- 4" size measures 5-1/2" high
- Includes white Snap-In deck plate and cover

3" Part # N10863

4" Part # N10864



Snap-In Deluxe Standard PVC Cowl Vent

- White with bright red interior
- Available in 3" or 4" sizes
- 3" size measures 8" high
- 4" size measures 10" high
- Includes white Snap-In deck plate and cover

3" Part # N10963

4" Part # N10964



Clam Shell Vents

- Ideal for ventilation needs where a taller vent would foul lines or restrict crew movement
- Work well as stern mounted ventilators for engine compartment
- Can be used for cabin ventilation with dorade boxes
- Flexible PVC construction
- Small clam shell dimensions: 2-1/2" H x 4-1/2" W x 5" L
- Large clam shell dimensions: 3" H x 5-3/8" W x 6-3/4" L

Small Part # N10873
Large Part # N10874

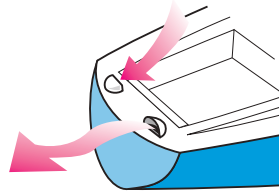

White Snap-In Deck Plate

- Includes Snap-In watertight cover
- Use with any Marinco® Snap-In vent system
- N10863DW requires a 3-3/4" diameter hole cutout
- N10864DW requires a 4-3/4" diameter hole cutout

3" Part # N10863DW
4" Part # N10864DW



Plastic Interior Trim Ring

- Finishes off interior installation of vent
- Can be installed in decks between 1" and 2" thick
- Available in 3" and 4" sizes
- White plastic construction
- **Note: Interior trim rings are not compatible with threaded deck plates**

3" Part # N10866
4" Part # N10867



Thru Bulkhead Hose Adapter

- For termination attachment of hose to bulkhead
- For attaching hose to cowl vent
- Can be used with Snap-In or threaded deck plates
- For use in decks or bulk heads of more than 1" thick

3" Part # N10869
4" Part # N10870

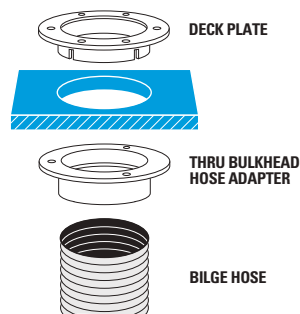



1 YEAR WARRANTY

Marine Fan

- 120° adjustable oscillating fan
- Can be set for stationary operation
- Mount on wall, ceiling or dash
- Built-in on/off switch
- Installation hardware included
- 12 volt DC operation, 1.2 amp draw
- Translucent fan blades
- 7.5" vinyl-coated fan guard
- Mounting base dimensions: 3.375" L x 1.5" W
- Stands 8" from mounting surface

Part # 900



1 YEAR WARRANTY

Folding Fan

- Fan folds out of the way when not in use
- Rotating louver directs air flow
- Mount on wall, ceiling or dash
- Built-in on/off switch
- Installation hardware included
- 12 volt DC operation, .8 amp draw
- Dimensions: 6.75" W x 5.06" H x 1.93" D

Part # 902



1 YEAR WARRANTY

Personal Fan

- 180° adjustable swivel fan
- Mount on wall, ceiling or dash
- Built-in on/off switch
- Installation hardware included
- 12 volt DC operation, 0.5 amp draw
- Compact design installs anywhere
- Great for windshield defogging
- Base Dimensions: 3" diameter
- Stands 5" from mounting surface

Part # 903-5

PN	Page	PN	Page	PN	Page	PN	Page	PN	Page
10001	83	102167	32	11028XLP	84	11090	80	118A	25
10010	84	102182	29	11029XLP	84	11091	80	121A	25
10011	84	10224	85	11031	81	11095	80	12224	85
10017XL	84	102N	28	11034	81	11096	79	123A	25
10018XL	84	103ELN	28	11034SC-B	81	11098	83	12BKT	42
10028XLP	84	103RN	28	11034SC-SS	81	11099	83	12MP.OEM	42
10029XLP	84	103RN.OEM	28	11035	83	110A	25	12VAD	42
10031	81	103RNX	33	11044	81	110R	28	12VBP	43
10035	83	103RNXPK	33	11045	81	11106	85	12VBP.OEM	43
10036	83	104SPP	25	11058	82	11107	85	12VBPS2	44
10079	80	104SPP-25.OEM	25	11059	82	11114	85	12VBPS2.OEM	44
10080	79	104SPP-50.OEM	25	11064	82	11115	85	12VBPS3	43
10082	82	104SPP.OEM	25	11066	82	11124	80	12VBPS3.OEM	43
10098	83	104SPPG	25	11079	80	11168	81	12VBR	43
10099	83	10524	85	11079SC-B	80	11185	82	12VBR.OEM	43
100EL	28	105SPP	25	11079SC-C	80	11187	79	12VBRAD	43
100R	28	105SPPG	25	11079SC-SS	80	11188	79	12VBRAD.OEM	43
10102	85	10624	85	11079SC-W	80	11190	80	12VBRS2	44
10104	85	106A	25	11079SN-B	80	11191	80	12VBRS2.OEM	44
10105	85	10MSPPX	33	11079SN-C	80	11194	79	12VBRS3	43
10106	85	10MSPPXP	33	11079SN-W	80	11196	79	12VBRS3.OEM	43
10107	85	11-004-N	91	11080	79	111A	25	12VCOMBO	41
10108	85	11001	83	11080SC-B	79	11225	80	12VCOMBO-B	41
10122	85	11017XLP	84	11080SC-SS	79	11226	80	12VCOMBON-B	41
101739	32	11018XLP	84	11080SC-W	79	115A	25	12VCOMBOW-B	41
102164	32	11024	80	11088	81	117A	25	12VCP	43

PN	Page	PN	Page	PN	Page	PN	Page	PN	Page
12VCP6	43	150BBI	51	199110PK	31	2018MB	45	22012A-P	90
12VCP52	44	150BBI-TM	51	199111PK	31	2018MB.OEM	45	22012MA-P	90
12VCP53	43	150BBI.OEM	51	199114	33	2018PKG	45	22014-P	90
12VDUSB	41	150BBIW	51	199115	34	202319	88	22040A	90
12VDUSB-B	41	150BBIW.OEM	51	199116	19	202320	88	22041A	90
12VDUSBN-B	41	150CC.OEM	51	199117	19	202432	96	22050A	89
12VDUSBW-B	41	150CCI	51	199117G	19	205CRCN	30	22051A	89
12VPG	41	150CCTM.OEM	51	199119	19	205CRPN	30	22150A	89
12VPG.OEM	41	150SSP	25	199119G	19	205CRR	30	22151A	89
12VPK	41	151225	20	199120	19	20MSPPX	33	22208A	90
12VPL.OEM	42	151250	20	199128	27	20MSPPXP	33	22209	90
12VRC	41	1520BI.OEM	31	199136	13	2100	55	22218A	90
12VRC.OEM	41	152AY	26	1M32AXP	34	2100-B	55	22219A	90
12VRC.PG	41	153AY	26	1MSPPX	33	2101	55	22224	85
12VRCO	40	154AY	26	1MSPPXP	33	2101-B	55	22230-P	90
12VRCO.PG	40	157AY	26	1RPC	27	2102	55	22240-R	90
12VRCW	41	1591-FI	31	1RPC50	27	2102-B	55	22250-HH	89
12VRCW.OEM	41	1591-FI.GRY.OEM	31	20036	40	2110A	55	22250-R	89
12VRCY	40	1591-FI.WHITE	31	200BBIW.OEM	51	2110A-B	55	22350-R	89
12VTR	45	15M32AX	34	2018BP-12	45	2111A	55	2300A	55
12VTR.OEM	45	15M32AXP	34	2018BP-24	45	2111A-17	55	2300A-B	55
12VXT	42	15MSPPX	33	2018BP-24.OEM	45	2111A-B	55	2303A	55
150025	20	15MSPPXP	33	2018BR	45	2111A-O	55	2303A-B	55
150025NL	20	162AY	26	2018BR-MB	45	2112A	55	2304A	55
150050	20	165AY	26	2018BR.OEM	45	2112A-B	55	2304A-B	55
150050NL	20	199109PK	31	2018BR.OEM.BPS	45	22011A-P	90	23050A	89

PN	Page	PN	Page	PN	Page	PN	Page	PN	Page
23051A	89	300275	42	3050BI	13	31116B	74	33092W	71
23150A	89	301BKRPL.OEM	16	305BC	44	31118B	74	33094	70
23151A	89	301CRMB	32	305BP	44	31120B	74	33101	68
23250-HH	89	301EL-B	13	305BP.OEM	44	31122B	74	33106A	71
23250-R	89	301EL-B.BLACK	13	305CRCN	28	31124B	74	33107A	71
23350-R	89	301EL-B.FR	13	305CRCN.OEM	28	32000	68	33110A	71
25MSPPX	33	301EL-B.GRAY	13	305CRCN.VPK	28	32001	68	33114A	71
25MSPPXP	33	301EL-B.OEM	13	305CRCXN	33	32002	68	33125	66
25SPPW	19	301EL-B.W/L	13	305CRCXNPK	33	33006A	71	33126	66
25SPPX	33	301EL-BX	33	305CRMB	32	33007A	71	33126S	74
2603-B	51	301EL-BXPK	33	305CRPN	28	33010A	71	33132A	71
2606A	51	301ELCB	13	305CRPN.OEM	28	33012A	71	33137A	71
2701A	50	301RCDKITIGN.OEM	16	305CRPN.VPK	28	33014A	71	33170A	71
2707A	49	301RCDPL.OEM	16	305CRR	28	33025	66	33184	70
2708A	49	303SSBKRPL.OEM	16	305CRRB	28	33026S	74	33184W	71
2710A	49	303SSEL-B	13	305CRRB.OEM	28	33028S	74	33186	70
2711A	49	303SSEL-B.OEM	13	31000	68	33030S	74	33186W	71
2713A	49	303SSEL-BX	33	31012B	74	33032A	71	33188	70
2720A	49	303SSEL-BXPK	33	31014B	74	33037A	71	33188W	70
2731A	49	303SSO	13	31016B	74	33070A	71	33190	70
2740A	49	303SSRCDPL.OEM	16	31018B	74	33084	70	33192	70
30000	68	304EL-B	13	31020B	74	33084W	71	33192W	71
30002	68	304EL-B.NT	13	31022B	74	33086	70	33194	70
30004	68	304EL-B.OEM	13	31024B	74	33086W	70	33505	75
30005	68	304EL-BX	33	31112B	74	33090	70	33513	75
300259	42	304EL-BX.NT	33	31114B	74	33092	70	33515	75

PN	Page	PN	Page	PN	Page	PN	Page	PN	Page
33517	75	34112S	74	37110	65	51203B	49	6153SPP	19
33901	74	34114B	74	37111	65	51203F	49	6153SPP-25	19
33919	74	34114S	74	37161	65	5262CRR	30	6153SPP-75	19
34000	66	34116B	74	37180	65	5262CRR.GRY	30	6153SPPW	19
34001	66	34116S	74	37181	65	5266CR	30	6153SPPX	34
34005	66	34118B	74	37200	65	5269CR	30	6343EL-B	14
34010	66	34118S	74	38000	66	5366CR	30	6343EL-BX	34
34011	66	34120B	74	38001	66	5369CR	30	6344EL-B.NT	15
34012B	74	34120S	74	38005	66	5369CR.OEM	30	6344EL-BCR.OEM	15
34012S	74	34122B	74	38010	66	6017	31	6351EL	14
34014B	74	34122S	74	38011	66	6018	31	6351EL-B	14
34014S	74	34124B	74	4006	54	6079	32	6351EL-BX	34
34015	66	34124S	74	4008	54	6080	32	6353EL	15
34016B	74	34126B	74	4012	54	6083CR	32	6353EL-B	15
34016S	74	34126S	74	4018	54	6084CR	32	6353EL-B.BLACK.OEM	15
34018B	74	34210	66	4700CR	30	6152SPP	19	6353EL-B.GRAY	15
34018S	74	35000	67	4721CR	30	6152SPP-12SC	19	6353EL-B.OEM	15
34020B	74	35010	67	4731CR	30	6152SPP-25	19	6353ELCB	15
34020S	74	35040	67	500EL	29	6152SPP-40	19	6353RCDKITIGN.OEM	16
34022B	74	35SPP	19	500R	29	6152SPP-75	19	6360CRN	29
34022S	74	36110	65	50SPP.OEM	19	6152SPPG	19	6360CRN.OEM	29
34024B	74	36111	65	50SPPW.OEM	19	6152SPPG-25	19	6360CRNX	34
34024S	74	36161	65	50SPPX	33	6152SPPW	19	6360CRNXPK	34
34026B	74	36180	65	510R	29	6152SPPW-25	19	6361CRN	29
34026S	74	36181	65	51202B	49	6152SPPW-55.P/O	19	6364CRN	29
34112B	74	37100	65	51202F	49	6152SPPW-75.P/O	19	6364CRN.OEM	29

PN	Page	PN	Page	PN	Page	PN	Page	PN	Page
6365CRN	29	71112	63	7715CRN	29	83182	64	CW125IT4	36
6365CRN.OEM	29	71182	63	7715CRN.OEM	29	900	100	CW125IT5	37
6369CR	29	729488	90	7715CRNX	34	902	100	CW754	36
6369CR.OEM	29	729489	90	7715CRNXPk	34	903-5	100	M051A	91
6370CR	29	729491	90	7715ELN	29	BAG	21	M051A-SS	91
6371EL	14	729492	90	7715ELN.OEM	29	CCVR-24	21	M051B	91
6371EL-B	14	729493	90	7717N	29	CLIP	21	M051B-SS	91
6371EL-B.OEM	14	729494	90	7717N.OEM	29	CLIP-01	21	M4100B12R	36
6371EL-BX	34	729528	90	7788CR	32	CS100IT4	36	M4100C12	36
6371ELX	34	729823-P	90	7879CR	32	CS100IT5	37	M4100C12R	36
6373EL	15	729825	90	7879CR-FI	32	CS30-12	18	M4100P12	36
6373EL-B	15	729827-P	90	7879CR-FI.OEM	32	CS30-25	18	M4100R12	36
6373EL-B.OEM	15	729828-P	90	82012	62	CS30-50	18	M5100B9R	37
6373EL-B.W/L	15	729829-P	90	82081	62	CS30-50W	18	M5100C9	37
6373EL.OEM	15	729830-P	90	82082	62	CS503-25	18	M5100C9R	37
6373ELMB	32	73113	61	82181	62	CS503-50	18	M5100P9	37
6401CRCX	35	73313	61	82182	62	CS504-25	18	M5100R9	37
6401CRPX	35	7420CR	32	82212	62	CS504-50	18	ML-005BW-STC	91
6401EL-BX	35	7420CR.OEM	32	82312	62	CS504-50W	18	ML-005BW/DSP	91
6402CRCX	35	755PP.OEM	19	83011	64	CS50EXT4*	36	ML-005NWW	91
6402CRPX	35	76030	75	83012	64	CS754	36	ML-005WW-STC	91
6402EL-BX	35	76080	75	83081	64	CS75IT4	36	ML-005WW/DSP	91
71011	63	76090	75	83082	64	CS75IT5	37	N10863	98
71012	63	76130	75	83111	64	CW1004	36	N10863DW	99
71081	63	76180	75	83112	64	CW100IT4	36	N10864	98
71082	63	76190	75	83181	64	CW100IT5	37	N10864DW	99

PN	Page	PN	Page	PN	Page	PN	Page
N10866	99	P-12D37	54	S15-30	23	TVHD	20
N10867	99	P-13A27	54	S15-504	23	U-3605	90
N10869	99	P-13A28	54	S20-15	23	U-3606	90
N10870	99	P-13A29	54	S20-30	23	USBA6	42
N10873	99	P-13A2A	54	S30-15	23	USBA6.OEM	42
N10874	99	P15-30	24	SPL-12B	88	WJ-B2005-A-35W	91
N10963	98	P15-30-25	24	SPL-12B.OEM	88	Y30-2-30	26
N10964	98	P15-30-25W	24	SPL-12C	88	Y503-2-30	26
N20020	97	P30-15	24	SPL-12C.OEM	88	Y504-2-30	26
N20030	97	P30-503	24	SPL-12W	88	Y504-2-503	26
N20790	96	P30-504	24	SPL-12W.OEM	88	Y504-2-504	26
N20803CAP	96	P503-30	24	SPL-24B.OEM	88		
N20803RING	96	P504-30	24	SPL-24C.OEM	88		
N20803S	96	P504-503	24	SPL-24W.OEM	88		
N20803W	96	PH6574TV	17	SPLR-1	88		
N20804CAP	96	PH6574TV.W/L	17	SPLR-2	88		
N20804RING	96	PH6592TV-SS	17	SPLR-3	88		
N20804S	96	PH6592TV-SS.OEM	17	STRAP	21		
N20804W	96	PH6597TV	20	TV6444	17		
N20890	96	PH6597TV.OEM	20	TV6574	17		
N28810	97	PH6599	20	TV6592	17		
P-11D03	54	PH6600	17	TV6592.OEM	17		
P-11D04	54	PH6601	17	TV97	20		
P-12D34	54	PH6629	17	TV97.OEM	20		
P-12D35	54	PHTV6599	20	TV99-25	20		
P-12D36	54	RY504-2-30	27	TV99W	20		

Ingress Protection (IP) Ratings Guide













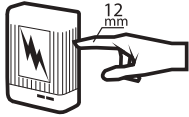

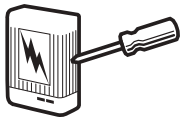
Example:

An IP65 rating can be determined using the adjacent table and example:

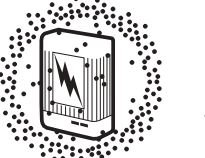
- The first number of the rating example, 6, in the gray column means the enclosure is dust tight
- The second number of the rating example, 5, in the blue column means the enclosure is protected against jets of water

The IP rating system was established by the International Electrotechnical Commission (IEC), an organization for international standards and conformity assessment. The IEC collaborates closely with the International Organization for Standardization (ISO). A complete description of the IP ratings and associated tests is found in IEC Publication 529. Although these ratings were initially developed as a way to classify enclosures, they now provide a convenient, practical way to compare levels of sealing. Many electrical products have an Ingress Protection (IP) rating which identifies the environmental factors needing consideration prior to the product's installation.

This is important when deciding when to mount products in a dry and clean environment versus a wet and/or dusty environment. The IP rating indicates the degree of protection provided. The numbers following IP represent levels of sealing and can range from no protection to full protection against dust and water. The table provides a description of the protection at each level.

SOLIDS		WATER	
1	 Protected against a solid object greater than 50 mm such as a hand.	1	 Protected against vertically falling drops of water. Limited ingress permitted.
2	 Protected against a solid object greater than 12 mm such as a finger.	2	 Protected against vertically falling drops of water with enclosure tilted up to 15 degrees from the vertical. Limited ingress permitted.
3	 Protected against a solid object greater than 2.5 mm such as a screwdriver.	3	 Protected against sprays of water up to 60 degrees from the vertical. Limited ingress permitted for three minutes.
4	 Protected against a solid object greater than 1 mm such as a wire.	4	 Protected against water splashed from all directions. Limited ingress permitted.
5	 Dust Protected. Limited ingress of dust permitted. Will not interfere with operation of the equipment. Two to eight hours.	5	 Protected against jets of water. Limited ingress permitted.
6	 Dust tight. No Ingress of dust. Two to eight hours.	6	 Water from heavy seas or water projected in powerful jets shall not enter the enclosure in harmful quantities.
		7	 Protection against the effects of immersion in water between 15 cm and 1 m for 30 minutes.
		8	 Protection against the effects of immersion in water under pressure for long periods.

Rating Example:

IP65

INGRESS PROTECTION

Marinco
N85 W12545 Westbrook Crossing
Menomonee Falls, WI 53051 USA
p 800.307.6702
f 800.799.3779

New Zealand
42 Apollo Drive
Rosedale, Auckland 0632
New Zealand
p +64.9.415.7261
f +64.9.415.9327

The Netherlands
Snijdersbergweg 93
1105 AN Amsterdam
The Netherlands
p +31(0)20 34 22 100
f +31(0)20 69 71 006

technical@marinco.com
marinco.com

©2019 Marinco
All rights reserved

Unauthorized copying or
reproduction is a violation
of applicable laws.

A division of
POWER PRODUCTS

MAR_CAT_003_0918