

Data sheet | Item number: 232-635

Strain relief housing; orange

[www.wago.com/232-635](http://www.wago.com/232-635)

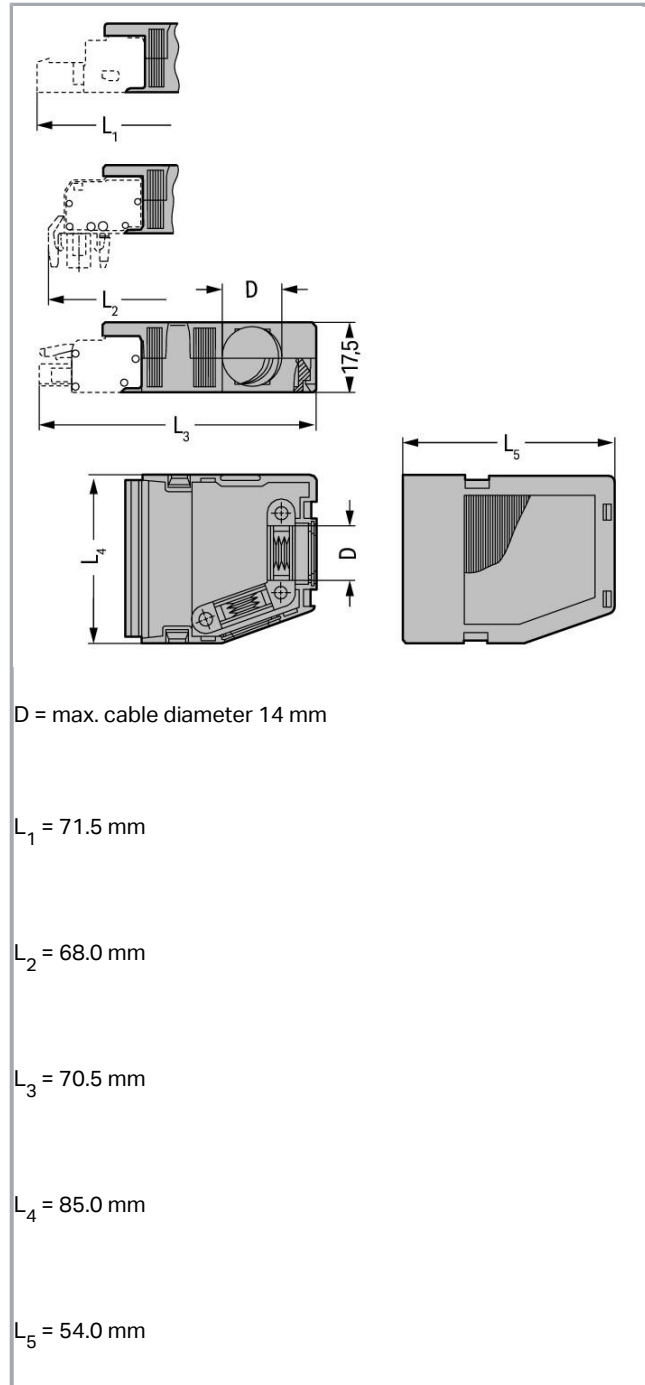
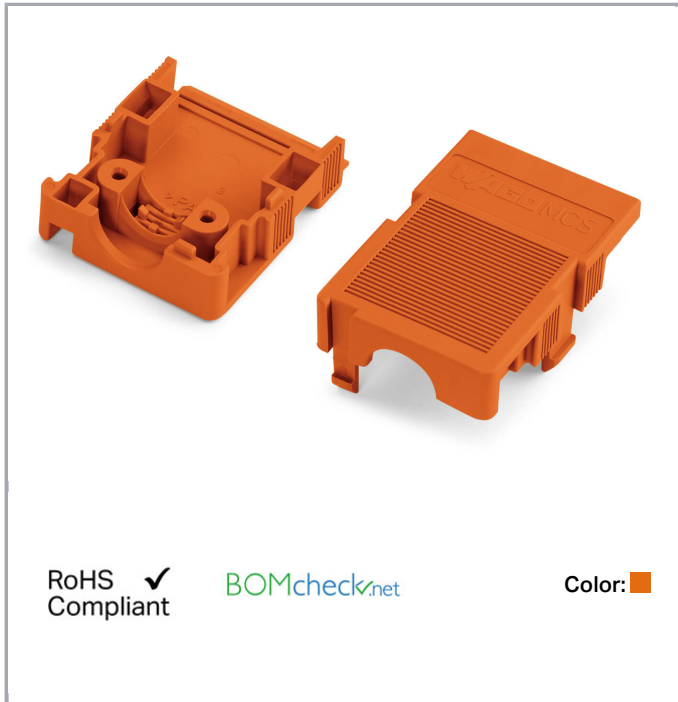

Subject to changes. Please also observe the further product documentation!

WAGO Kontakttechnik GmbH & Co. KG  
Hansastr. 27  
32423 Minden  
Phone: +49571 887-0 | Fax: +49571 887-169  
Email: [info.de@wago.com](mailto:info.de@wago.com) | Web: [www.wago.com](http://www.wago.com)

Do you have any questions about our products?  
We are always happy to take your call at +49 (571) 887-44222.



## Item description

- Suitable for cable clamp
- 1 x cable outlet, rear

## Data

### Connection data

Pole No.	5
----------	---

### Geometrical Data

Pin spacing	5,08 mm / 0.2 inch
Width	28 mm / 1.102 inch
Height	17,5 mm / 0.689 inch
Depth	41,5 mm / 1.634 inch

### Mechanical data

Suitable	for standard male and female connectors
----------	-----------------------------------------

### Material Data

Color	orange
Fire load	0.198 MJ
Weight	6.6 g

### Commercial data

Product Group	3 (Multi Conn. System)
Packaging type	BOX
Country of origin	DE
GTIN	4017332283113
Customs tariff number	39269097900

## Approvals / Certificates

### Country specific Approvals

Logo	Approval	Additional Approval Text	Certificate name
	<b>KEMA/KEUR</b> DEKRA Certification B.V.	EN 61984	2190761.01

Subject to changes. Please also observe the further product documentation!

WAGO Kontakttechnik GmbH & Co. KG  
 Hansastr. 27  
 32423 Minden  
 Phone: +49571 887-0 | Fax: +49571 887-169  
 Email: [info.de@wago.com](mailto:info.de@wago.com) | Web: [www.wago.com](http://www.wago.com)

Do you have any questions about our products?  
 We are always happy to take your call at +49 (571) 887-44222.



### Ship Approvals

Logo	Approval	Additional Approval Text	Certificate name
	<b>ABS</b> American Bureau of Shipping	-	19- HG15869876- PDA

### UL-Approvals

Logo	Approval	Additional Approval Text	Certificate name
	<b>UL</b> UL International Germany GmbH	UL 1977	E45171



### Counterpart

### Compatible products

#### General accessories

	<b>Item no.: 209-173</b> Fixing screw; for cable clamp; 7 or more poles	<a href="http://www.wago.com/209-173">www.wago.com/209-173</a>
	<b>Item no.: 209-176</b> Fixing screws; for cable clamp; 4- to 6-pole	<a href="http://www.wago.com/209-176">www.wago.com/209-176</a>
	<b>Item no.: 209-177</b> Cable clamp; for strain relief; 4- to 6-pole	<a href="http://www.wago.com/209-177">www.wago.com/209-177</a>













#### Marking accessories

	<b>Item no.: 2009-115</b> WMB-Inline; for Smart Printer; 1500 pieces on roll; stretchable 5 - 5.2 mm; plain; snap-on type; white	<a href="http://www.wago.com/2009-115">www.wago.com/2009-115</a>
	<b>Item no.: 2009-115/000-002</b> WMB-Inline; for Smart Printer; 1500 pieces on roll; stretchable 5 - 5.2 mm; plain; snap-on type; yellow	<a href="http://www.wago.com/2009-115/000-002">www.wago.com/2009-115/000-002</a>

Subject to changes. Please also observe the further product documentation!

WAGO Kontakttechnik GmbH & Co. KG  
Hansastr. 27  
32423 Minden  
Phone: +49571 887-0 | Fax: +49571 887-169  
Email: [info.de@wago.com](mailto:info.de@wago.com) | Web: [www.wago.com](http://www.wago.com)

Do you have any questions about our products?  
We are always happy to take your call at +49 (571) 887-44222.

	<p><b>Item no.: 2009-115/000-006</b>                      WMB-Inline; for Smart Printer; 1500 pieces on roll; stretchable 5 - 5.2 mm; plain; snap-on type; blue</p>	<a href="http://www.wago.com/2009-115/000-006">www.wago.com/2009-115/000-006</a>
	<p><b>Item no.: 2009-115/000-007</b>                      WMB-Inline; for Smart Printer; 1500 pieces on roll; stretchable 5 - 5.2 mm; plain; snap-on type; gray</p>	<a href="http://www.wago.com/2009-115/000-007">www.wago.com/2009-115/000-007</a>
	<p><b>Item no.: 2009-115/000-012</b>                      WMB-Inline; for Smart Printer; 1500 pieces on roll; stretchable 5 - 5.2 mm; plain; snap-on type; orange</p>	<a href="http://www.wago.com/2009-115/000-012">www.wago.com/2009-115/000-012</a>
	<p><b>Item no.: 2009-115/000-017</b>                      WMB-Inline; for Smart Printer; 1500 pieces on roll; stretchable 5 - 5.2 mm; plain; snap-on type; light green</p>	<a href="http://www.wago.com/2009-115/000-017">www.wago.com/2009-115/000-017</a>
	<p><b>Item no.: 2009-115/000-023</b>                      WMB-Inline; for Smart Printer; 1500 pieces on roll; stretchable 5 - 5.2 mm; plain; snap-on type; green</p>	<a href="http://www.wago.com/2009-115/000-023">www.wago.com/2009-115/000-023</a>
	<p><b>Item no.: 2009-115/000-024</b>                      WMB-Inline; for Smart Printer; 1500 pieces on roll; stretchable 5 - 5.2 mm; plain; snap-on type; violet</p>	<a href="http://www.wago.com/2009-115/000-024">www.wago.com/2009-115/000-024</a>
	<p><b>Item no.: 793-501</b>                      WMB marking card; as card; not stretchable; plain; snap-on type; white</p>	<a href="http://www.wago.com/793-501">www.wago.com/793-501</a>
	<p><b>Item no.: 793-501/000-002</b>                      WMB marking card; as card; not stretchable; plain; snap-on type; yellow</p>	<a href="http://www.wago.com/793-501/000-002">www.wago.com/793-501/000-002</a>
	<p><b>Item no.: 793-501/000-005</b>                      WMB marking card; as card; not stretchable; plain; snap-on type; red</p>	<a href="http://www.wago.com/793-501/000-005">www.wago.com/793-501/000-005</a>
	<p><b>Item no.: 793-501/000-006</b>                      WMB marking card; as card; not stretchable; plain; snap-on type; blue</p>	<a href="http://www.wago.com/793-501/000-006">www.wago.com/793-501/000-006</a>
	<p><b>Item no.: 793-501/000-007</b>                      WMB marking card; as card; not stretchable; plain; snap-on type; gray</p>	<a href="http://www.wago.com/793-501/000-007">www.wago.com/793-501/000-007</a>
	<p><b>Item no.: 793-501/000-012</b>                      WMB marking card; as card; not stretchable; plain; snap-on type; orange</p>	<a href="http://www.wago.com/793-501/000-012">www.wago.com/793-501/000-012</a>
	<p><b>Item no.: 793-501/000-017</b>                      WMB marking card; as card; not stretchable; plain; snap-on type; light green</p>	<a href="http://www.wago.com/793-501/000-017">www.wago.com/793-501/000-017</a>

Subject to changes. Please also observe the further product documentation!



**Item no.: 793-501/000-023**  
WMB marking card; as card; not stretchable; plain; snap-on type; green

[www.wago.com/793-501/000-023](http://www.wago.com/793-501/000-023)



**Item no.: 793-501/000-024**  
WMB marking card; as card; not stretchable; plain; snap-on type; violet

[www.wago.com/793-501/000-024](http://www.wago.com/793-501/000-024)



**Item no.: 793-5501**  
WMB marking card; as card; for terminal block width 5 - 17.5 mm; stretchable 5 - 5.2 mm; plain; snap-on type; white

[www.wago.com/793-5501](http://www.wago.com/793-5501)



**Item no.: 793-5501/000-002**  
WMB marking card; as card; for terminal block width 5 - 17.5 mm; stretchable 5 - 5.2 mm; plain; snap-on type; yellow

[www.wago.com/793-5501/000-002](http://www.wago.com/793-5501/000-002)



**Item no.: 793-5501/000-005**  
WMB marking card; as card; for terminal block width 5 - 17.5 mm; stretchable 5 - 5.2 mm; plain; snap-on type; red

[www.wago.com/793-5501/000-005](http://www.wago.com/793-5501/000-005)



**Item no.: 793-5501/000-006**  
WMB marking card; as card; for terminal block width 5 - 17.5 mm; stretchable 5 - 5.2 mm; plain; snap-on type; blue

[www.wago.com/793-5501/000-006](http://www.wago.com/793-5501/000-006)



**Item no.: 793-5501/000-007**  
WMB marking card; as card; for terminal block width 5 - 17.5 mm; stretchable 5 - 5.2 mm; plain; snap-on type; gray

[www.wago.com/793-5501/000-007](http://www.wago.com/793-5501/000-007)



**Item no.: 793-5501/000-012**  
WMB marking card; as card; for terminal block width 5 - 17.5 mm; stretchable 5 - 5.2 mm; plain; snap-on type; orange

[www.wago.com/793-5501/000-012](http://www.wago.com/793-5501/000-012)



**Item no.: 793-5501/000-014**  
WMB marking card; as card; for terminal block width 5 - 17.5 mm; stretchable 5 - 5.2 mm; plain; snap-on type; brown

[www.wago.com/793-5501/000-014](http://www.wago.com/793-5501/000-014)



**Item no.: 793-5501/000-017**  
WMB marking card; as card; for terminal block width 5 - 17.5 mm; stretchable 5 - 5.2 mm; plain; snap-on type; green

[www.wago.com/793-5501/000-017](http://www.wago.com/793-5501/000-017)



**Item no.: 793-5501/000-023**  
WMB marking card; as card; for terminal block width 5 - 17.5 mm; stretchable 5 - 5.2 mm; plain; snap-on type; light green

[www.wago.com/793-5501/000-023](http://www.wago.com/793-5501/000-023)



**Item no.: 793-5501/000-024**  
WMB marking card; as card; for terminal block width 5 - 17.5 mm; stretchable 5 - 5.2 mm; plain; snap-on type; violet

[www.wago.com/793-5501/000-024](http://www.wago.com/793-5501/000-024)

## Downloads

### CAD/CAE-Data

#### CAD data

Subject to changes. Please also observe the further product documentation!

WAGO Kontakttechnik GmbH & Co. KG  
Hansastr. 27  
32423 Minden  
Phone: +49571 887-0 | Fax: +49571 887-169  
Email: [info.de@wago.com](mailto:info.de@wago.com) | Web: [www.wago.com](http://www.wago.com)

Do you have any questions about our products?  
We are always happy to take your call at +49 (571) 887-44222.

2D/3D Models 232-635

[URL](#)

[Download](#)

#### CAE data

EPLAN Data Portal 232-635

[URL](#)

[Download](#)

ZUKEN Portal 232-635

[URL](#)

[Download](#)

## Installation Notes

### Installation

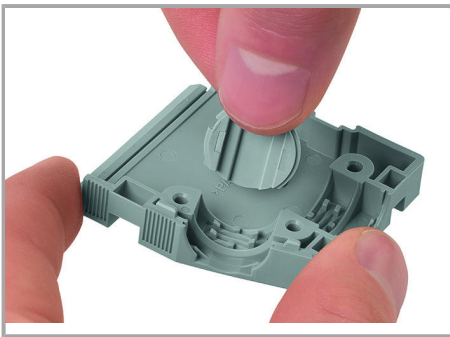

Snapping a cover into the unused cable outlet.

### Installation

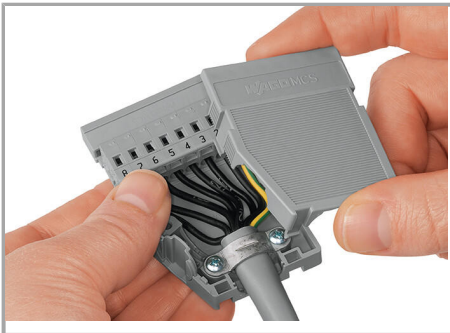

Strain relief housing shown with a male connector equipped with CAGE CLAMP®

### Installation

Subject to changes. Please also observe the further product documentation!

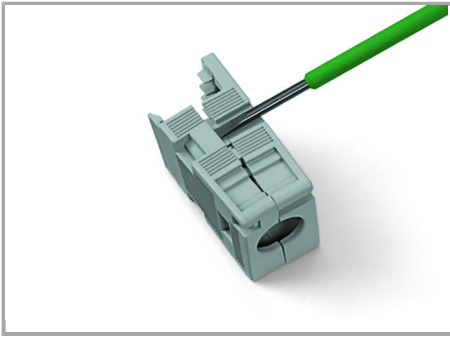

Disassembling a strain relief housing is only possible using an operating tool (e.g., 210-719).

Subject to changes. Please also observe the further product documentation!