

2325347-3 ✓ ACTIVE

Power Versa-Lock | Power Versa-Lock 5.0

TE Internal #: 2325347-3

Power Versa-Lock 5.0, Rectangular Connector Seals, Interface Seal, Wire-to-Wire, 3 Position, 5mm [.197in] Centerline, Sealable, Wire & Cable

[View on TE.com >](#)



Connectors > Rectangular Connectors > Rectangular Connector Accessories > Rectangular Connector Seals



Connector Seal Type: **Interface Seal**

Connector System: **Wire-to-Wire**

Number of Positions: **3**

Centerline (Pitch): **5 mm [.197 in]**

Sealable: **Yes**

## Features

### Product Type Features

Accessory Color	Blue
Product Type	Accessory
Connector Seal Type	Interface Seal
Connector System	Wire-to-Wire
Sealable	Yes
Connector & Contact Terminates To	Wire & Cable

### Configuration Features

Number of Positions	3
---------------------	---

### Body Features

Material	Silicone Rubber
Seal Color	Blue
Seal Material	Silicone Rubber

### Housing Features

Centerline (Pitch)	5 mm [.197 in]
--------------------	----------------

### Usage Conditions

Operating Temperature Range	-30 – 105 °C [-22 – 221 °F]
-----------------------------	-----------------------------

### Operation/Application



For Use With	Power Versa-Lock Sealed Connectors
Circuit Application	Power & Signal

**Other**

Comment	IP67
---------	------

**Product Compliance**

[For compliance documentation, visit the product page on TE.com>](#)

EU RoHS Directive 2011/65/EU	Compliant
EU ELV Directive 2000/53/EC	Compliant
China RoHS 2 Directive MIIT Order No 32, 2016	No Restricted Materials Above Threshold
EU REACH Regulation (EC) No. 1907/2006	Current ECHA Candidate List: JAN 2021 (211) Candidate List Declared Against: JAN 2021 (211) Does not contain REACH SVHC
Halogen Content	Low Halogen - Br, Cl, F, I < 900 ppm per homogenous material. Also BFR/CFR/PVC Free
Solder Process Capability	Not reviewed for solder process capability

Product Compliance Disclaimer

This information is provided based on reasonable inquiry of our suppliers and represents our current actual knowledge based on the information they provided. This information is subject to change. The part numbers that TE has identified as EU RoHS compliant have a maximum concentration of 0.1% by weight in homogenous materials for lead, hexavalent chromium, mercury, PBB, PBDE, DBP, BBP, DEHP, DIBP, and 0.01% for cadmium, or qualify for an exemption to these limits as defined in the Annexes of Directive 2011/65/EU (RoHS2). Finished electrical and electronic equipment products will be CE marked as required by Directive 2011/65/EU. Components may not be CE marked. Additionally, the part numbers that TE has identified as EU ELV compliant have a maximum concentration of 0.1% by weight in homogenous materials for lead, hexavalent chromium, and mercury, and 0.01% for cadmium, or qualify for an exemption to these limits as defined in the Annexes of Directive 2000/53/EC (ELV). Regarding the REACH Regulation, the information TE provides on SVHC in articles for this part number is based on the latest European Chemicals Agency (ECHA) 'Guidance on requirements for substances in articles' posted at this URL: <https://echa.europa.eu/guidance-documents/guidance-on-reach>

**Compatible Parts**



TE Part # 1-2378158-3  
Power Versa-Lock CAP, 1X3 KEY A



TE Part # 1-2378159-3  
Power Versa-Lock PLUG, 1X3 KEY A



TE Part # 1-2336229-6  
Power Versa-Lock PLUG, 2X3 KEY A



TE Part # 2-2336229-6  
Power Versa-Lock PLUG, 2X3 KEY B

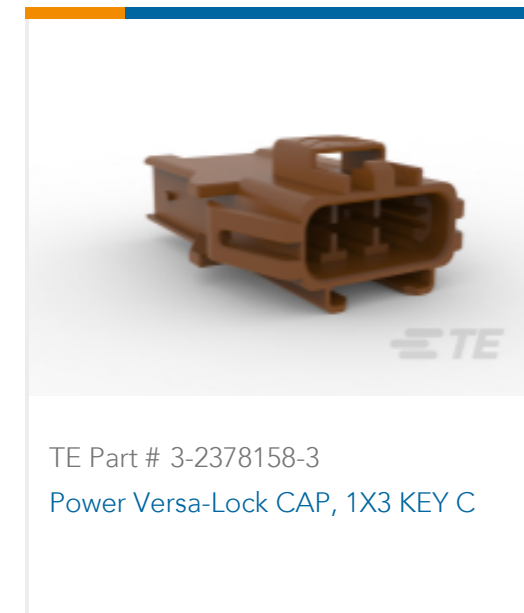
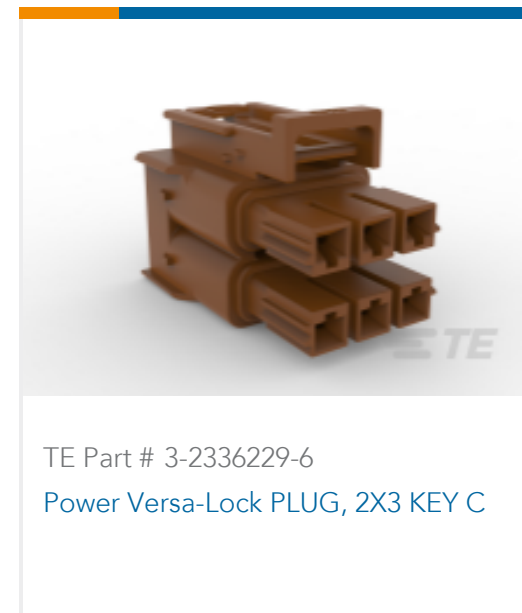

## Also in the Series | Power Versa-Lock 5.0

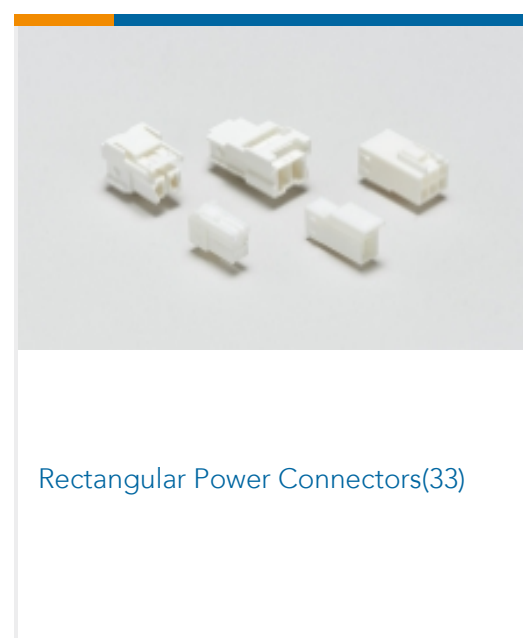
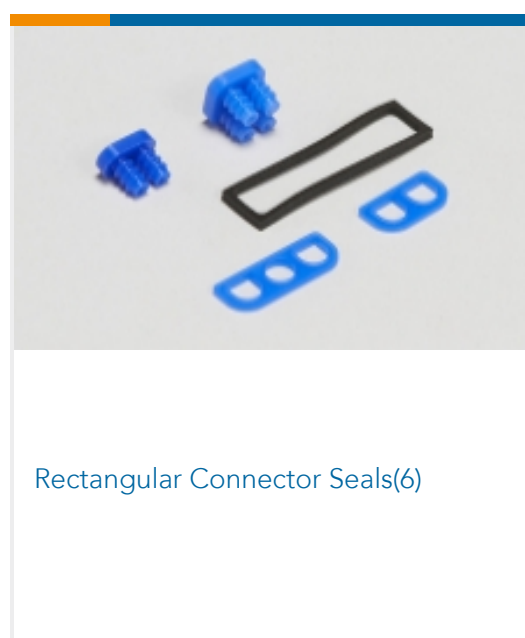
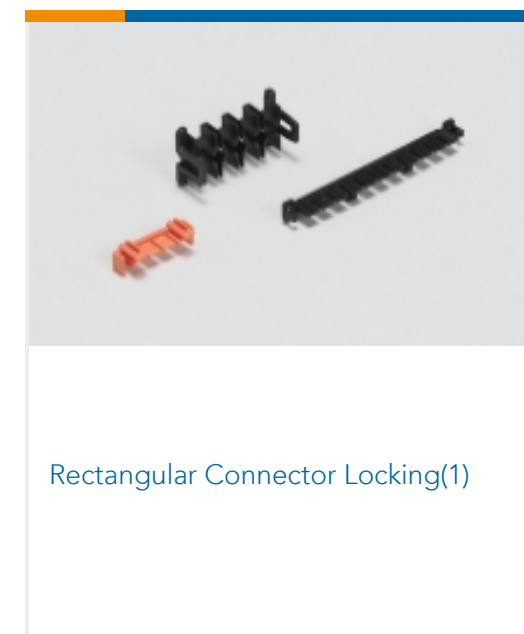
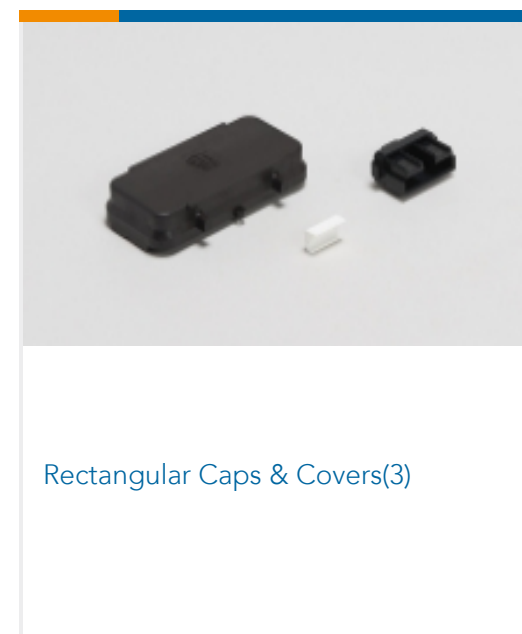
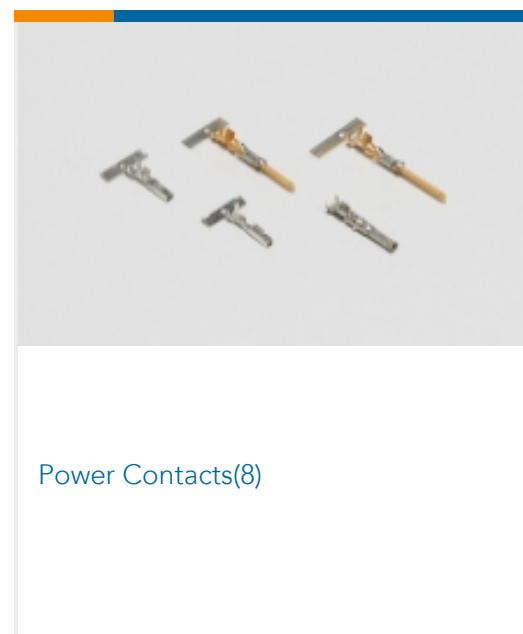
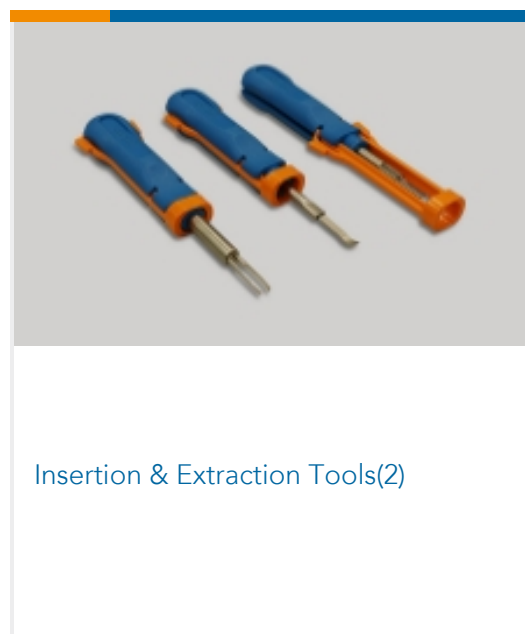

## Customers Also Bought

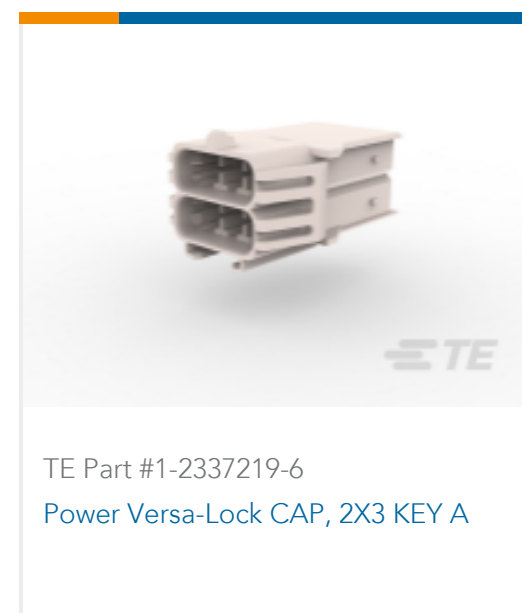

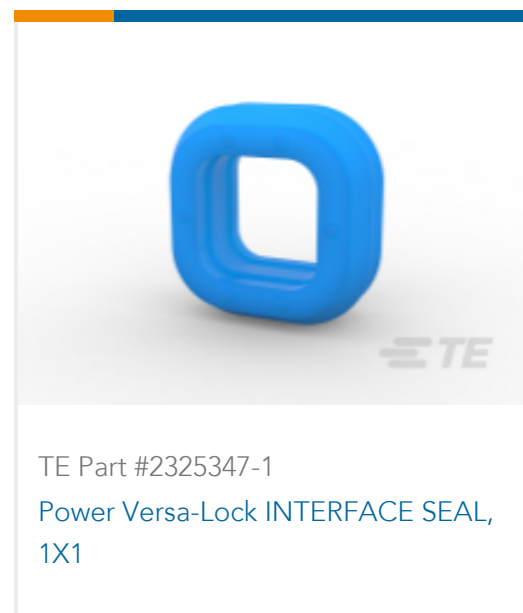
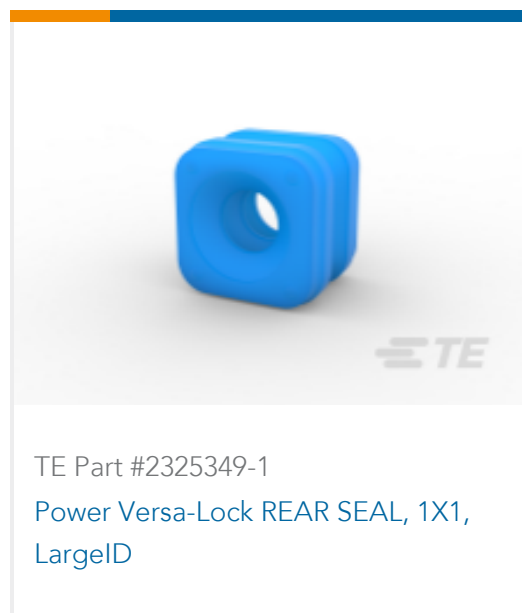
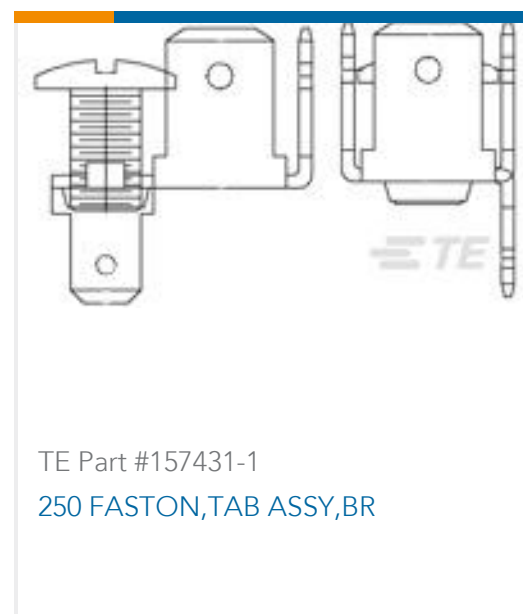

## Documents

### CAD Files

#### 3D PDF

3D

#### Customer View Model

[ENG\\_CVM\\_CVM\\_2325347-3\\_A.2d\\_dxf.zip](#)

English

#### Customer View Model

[ENG\\_CVM\\_CVM\\_2325347-3\\_A.3d\\_igs.zip](#)

English

#### Customer View Model

[ENG\\_CVM\\_CVM\\_2325347-3\\_A.3d\\_stp.zip](#)

English

By downloading the CAD file I accept and agree to the [Terms and Conditions](#) of use.

### Product Specifications

#### Engineering Report

English

### Instruction Sheets

#### Instruction Sheet (U.S.)

English