

Item no.: 231-612/019-000
 Product description: MALE CONNECTOR; WITH FIXING FLANGE; 12 POLE; PIN SPACING 5 MM / 0.197 IN; CAGE CLAMP®CONNECTION; FOR SCREW OR SIMILAR MOUNTING TYPES

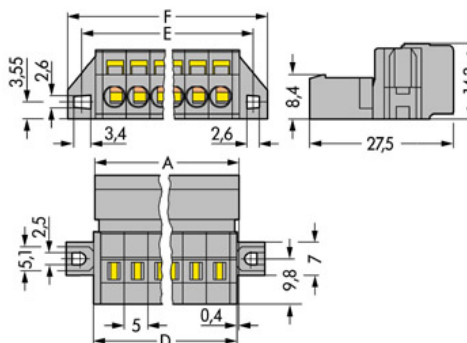

Packing unit 25 pieces

Product group	3 (Multi Conn. System)
Pin spacing from	5 mm
Pin spacing from	0,197 in
pole count	12
Cross section from [mm ²]	0,08 mm ²
Cross section to [mm ²]	2,5 mm ²
Cross section from [AWG]	28 AWG
Cross section to [AWG]	12 AWG
Connection method	CAGE CLAMP®CONNECTION
Measured voltage EN	250 V
Measured shock voltage	4 kV
Pollution degree	3
Current intensity EN	12 A
Weight	19,28 g
Color	grey
No. of connection Points	12
No. of potentials	12
Height	14,3 mm
Height	0,563 in
Width	74,8 mm
Width	2,945 in
Depth	27,5 mm



Depth	1,083 in
Strip length from	8 mm
Strip length to	9 mm
Strip length	0,33 in



Item number	Admission office	Approval no.	Voltage [V]	Current [A]	Cross section [mm ²]
231-612/019-000	ABS	04-HG469925-PDA	400	12	5,0
231-612/019-000	BV	11915/A0	400	16	2,5
231-612/019-000	CCA	5764	250	12	0,08-2,5
231-612/019-000	CSA	154112-1466354	300	15	22-12
231-612/019-000	DEMKO	88126	250		2,5
231-612/019-000	GL	17296-00HH	400	12	5,0
231-612/019-000	KEMA	2083746.02	250	12	0,08-2,5
231-612/019-000	KR	HMB05880-EL003	250/400	12/16	2,5
231-612/019-000	LR	96/20035	400	12	5,0
231-612/019-000	NEMKO	P94101840	250		2,5
231-612/019-000	RMR	11130002	400	12	5,0
231-612/019-000	UR	E45171	600	15	12
231-612/019-000	UR	E45172	300	15	22-12

Sorting criteria: admission office - approval number

© WAGO Kontakttechnik GmbH & Co. KG

Specifications are subject to changes and errors may be expected