

Item no.: 231-112/027-000
 Product description: FEMALE PLUG; WITH FIXING FLANGE; 12 POLE; PIN SPACING 5 MM / 0.197 IN; WITH CODIG FINGERS; WITH INTEGRATED FIXING FLANGES

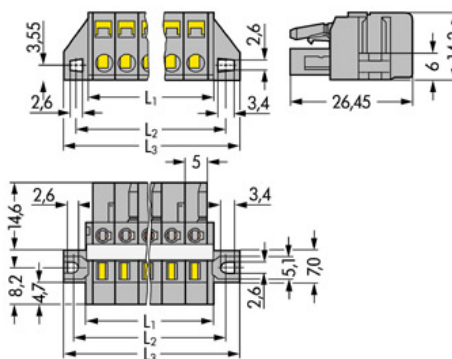

Packing unit 25 pieces

Product group	3 (Multi Conn. System)
Pin spacing from	5 mm
Pin spacing from	0,197 in
pole count	12
Cross section from [mm ²]	0,08 mm ²
Cross section to [mm ²]	2,5 mm ²
Cross section from [AWG]	28 AWG
Cross section to [AWG]	12 AWG
Connection method	CAGE CLAMP®CONNECTION
Measured voltage EN	250 V
Measured shock voltage	4 kV
Pollution degree	3
Current intensity EN	16 A
Weight	22,71 g
Color	grey
No. of connection Points	12
No. of potentials	12
Height	14,3 mm
Height	0,563 in
Width	74,8 mm
Width	2,945 in
Depth	26,45 mm



Depth	1,041 in
Strip length from	8 mm
Strip length to	9 mm
Strip length	0,33 in



Item number	Admission office	Approval no.	Voltage [V]	Current [A]	Cross section [mm ²]
231-112/027-000	ABS	04-HG469925-PDA	400	16	5,0
231-112/027-000	BV	11915/A0	400	16	2,5
231-112/027-000	CCA	5764	250	16	0,08-2,5
231-112/027-000	CSA	154112-1466354	300	15	22-12
231-112/027-000	DEMKO	88126	250	16	2,5
231-112/027-000	GL	17296-00HH	400	16	5,0
231-112/027-000	KEMA	2083746.02	250	16	0,08-2,5
231-112/027-000	KR	HMB05880-EL003	250/400	12/16	2,5
231-112/027-000	LR	91/20112(E3)	400	16	5,0
231-112/027-000	RMR	11130002	400	16	5,0
231-112/027-000	UR	E45171	600	15	12
231-112/027-000	UR	E45172	300	15	22-12

Sorting criteria: admission office - approval number

© WAGO Kontakttechnik GmbH & Co. KG

Specifications are subject to changes and errors may be expected