

Data sheet | Item number: 221-500

Mounting carrier; 221 Series - 4 mm²; for DIN-35 rail mounting/screw mounting; orange

www.wago.com/221-500

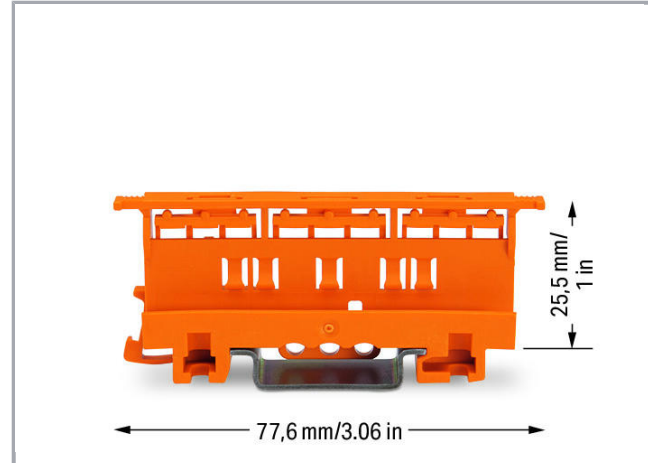
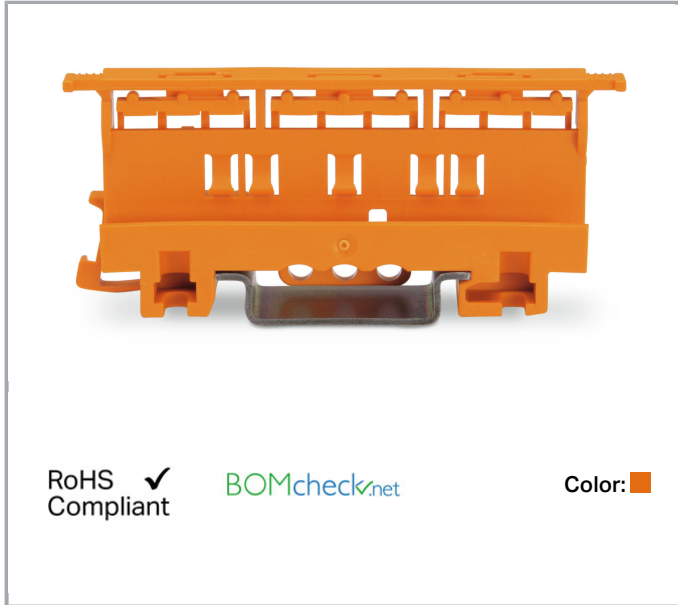

Data

Geometrical Data

Width	17.5 mm / 0.689 inch
Height from upper-edge of DIN-35 rail	25.5 mm / 1.004 inch
Depth	77.6 mm / 3.055 inch

Material Data

Color	orange
Insulating material	Polyamide 66 (PA 66)
Flammability class per UL94	V0
Weight	9.6 g

Commercial data

Packaging type	BOX
Country of origin	CN
GTIN	4055143421942
Customs Tariff No.	39269097900

Subject to changes.

WAGO Kontakttechnik GmbH & Co. KG
Hansastr. 27
32423 Minden
Phone: +49571 887-0 | Fax: +49571 887-169
Email: info.de@wago.com | Web: www.wago.com

Do you have any questions about our products?
We are always happy to take your call at +49 (571) 887-44222.

Compatible products

Mounting adapter



Item no.: 222-505

Strain relief plate; for mounting carrier; 221 or 222 Series, can be snapped

www.wago.com/222-505



Item no.: 222-510

Angled DIN-rail adapter; in combination with mounting carrier; 221-500 or 222-500; for DIN-35 rail mounting; gray

www.wago.com/222-510

Marking accessories



Item no.: 210-833

Marking strips; on reel; 6 mm wide; plain; Self-adhesive; white

www.wago.com/210-833

Downloads

Documentation

Bid Text

221-500 docx - Datei	Jan 23, 2019	docx 14.9 kB	Download
221-500 X81 - Datei	Feb 19, 2019	xml 2.8 kB	Download
Additional Information Technical explanations	Apr 3, 2019	pdf 2.1 MB	Download

CAD/CAE-Data

CAD data

2D/3D Models 221-500	URL	Download
----------------------	-----	----------

CAE data

EPLAN Data Portal 221-500	Download
---------------------------	----------

Installation Notes

Subject to changes.

WAGO Kontakttechnik GmbH & Co. KG
Hansastr. 27
32423 Minden
Phone: +49571 887-0 | Fax: +49571 887-169
Email: info.de@wago.com | Web: www.wago.com

Do you have any questions about our products?
We are always happy to take your call at +49 (571) 887-44222.

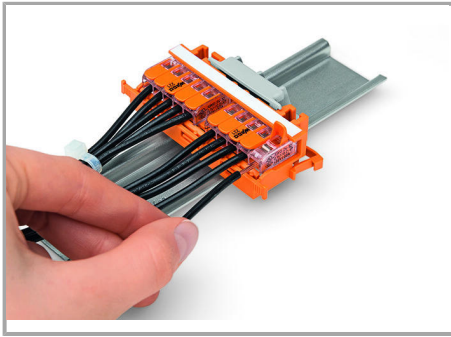

CAGE CLAMP® connection:

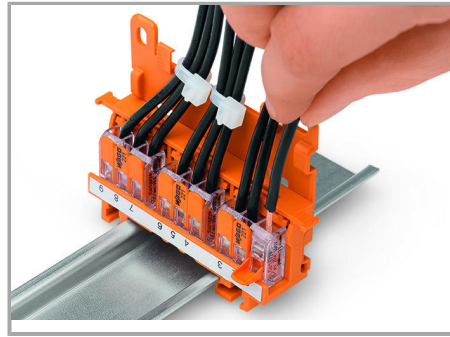

Removing a conductor.

Conductor termination with connectors fitted in a mounting carrier

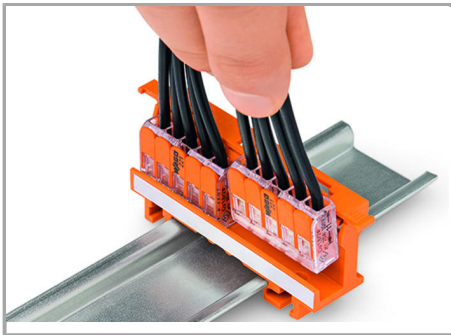

Inserting a connector into the mounting carrier.

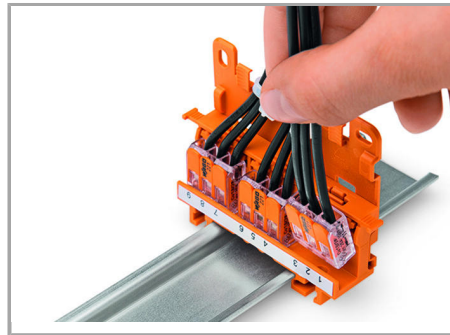

Inserting a connector into the mounting carrier.

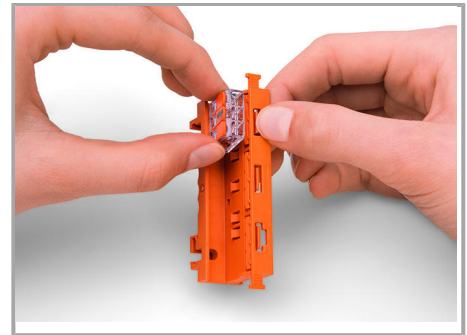

Removing a connector from the mounting carrier.

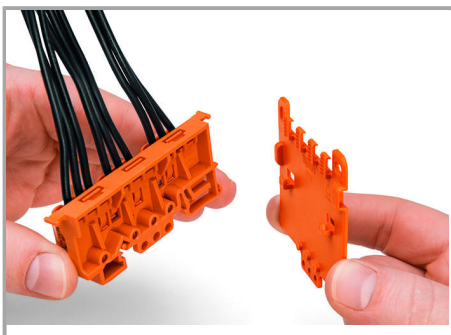

Securing a strain relief plate (222-505) to the mounting carrier.

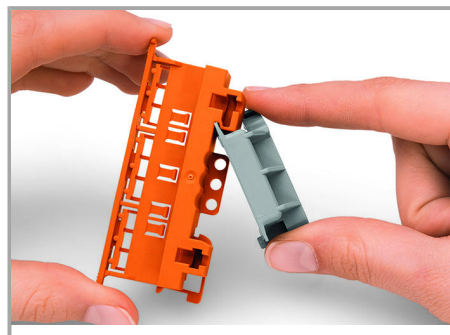

Snapping the angled DIN-rail adapter (222-510) onto the mounting carrier.

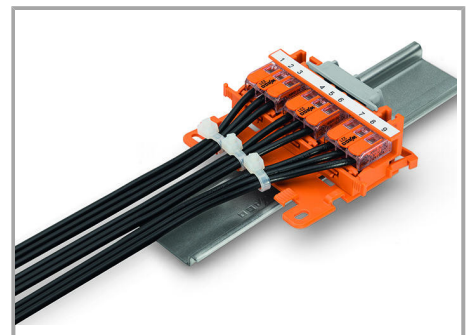

Horizontal mounting on DIN-35 rail using an angled DIN-rail adapter.

Subject to changes.

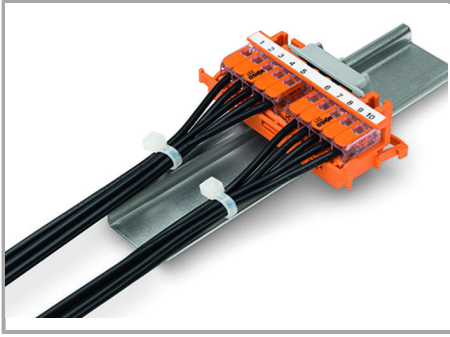

Horizontal mounting on DIN-35 rail using an angled DIN-rail adapter.

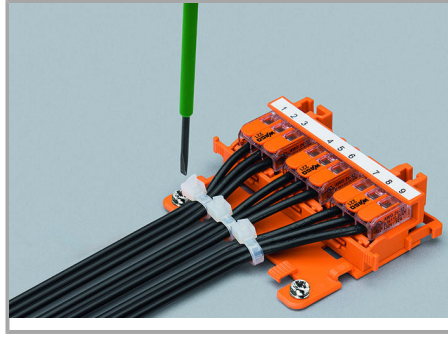

Horizontal screw mounting with strain relief plate on a flat surface

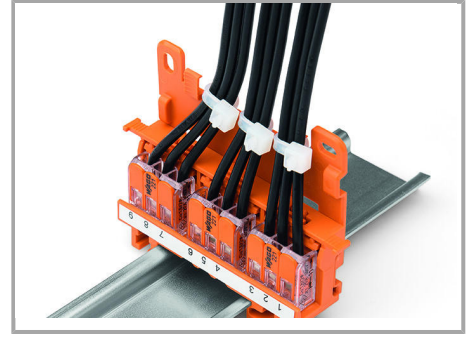

Vertical mounting with strain relief plate on DIN-35 rail.

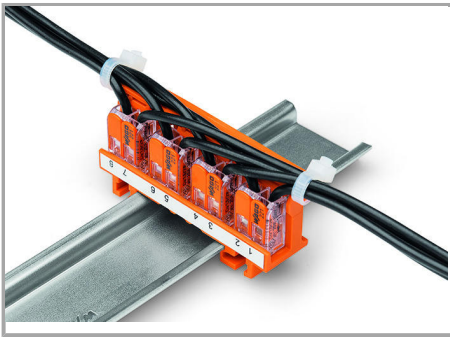

Strain relief via cable ties on the mounting carrier (transverse to the connectors' wiring direction) – clamping units labeled via marking strips (210-334).

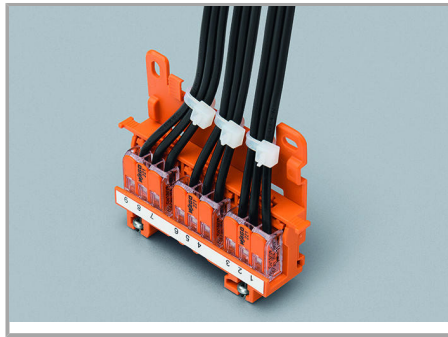

Vertical screw mounting with strain relief plate on a flat surface.

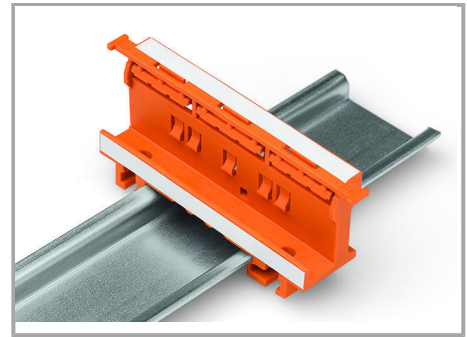

Mounting carrier on a DIN-35 rail

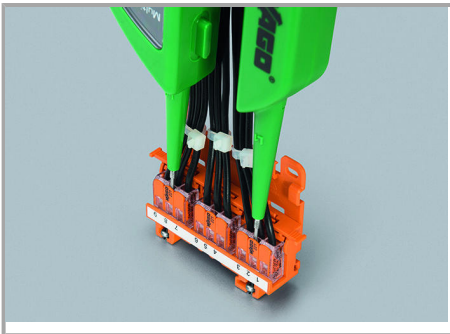

Testing connectors via test slots on top of the carrier.

Subject to changes.