

213852-1 ✓ ACTIVE

AMP | AMP CPC

TE Internal #: 213852-1

AMP CPC, Circular Power Connectors, Housing, Operating Voltage
600 VDC, Wire-to-Wire, 19 Position, Wire & Cable, Plug, Reverse
Gender, Pin

[View on TE.com >](#)



Connectors > Power Connectors > Circular Power > Circular Power Connectors > CPC SERIES 1



Connector Product Type: **Housing**

Operating Voltage: **600 VDC**

Connector System: **Wire-to-Wire**

Number of Positions: **19**

Sealable: **No**

[All CPC SERIES 1 \(57\)](#)

Features

Product Type Features

Connector Product Type	Housing
Connector System	Wire-to-Wire
Sealable	No
Connector & Contact Terminates To	Wire & Cable
Connector & Housing Type	Plug
Circular Connector Shell Type	All Plastic

Configuration Features

Reverse Numbering	With
Number of Positions	19
Number of Power Positions	0
Keying	B
Number of Signal Positions	19

Electrical Characteristics

Operating Voltage	600 VAC
-------------------	---------

Contact Features

Reverse Gender	Yes
Contact Type	Pin



Contact Protection	With
--------------------	------

Mechanical Attachment

Screw & Hole Thread Size	1-3/8 - 18 UNEF-2A
--------------------------	--------------------

Connector Mounting Type	Cable Mount (Free-Hanging)
-------------------------	----------------------------

Mating Alignment	With
------------------	------

Mating Retention	With
------------------	------

Panel Mount Feature	Without
---------------------	---------

Mating Alignment Type	Keyed
-----------------------	-------

Mating Retention Type	Threaded Coupling
-----------------------	-------------------

Housing Features

Body Orientation	Straight
------------------	----------

Housing Color	Black
---------------	-------

Housing Material	Nylon 6/6 GF
------------------	--------------

Circular Connector Shell Size	23
-------------------------------	----

Usage Conditions

Operating Temperature Range	-55 – 105 °C[-67 – 221 °F]
-----------------------------	----------------------------

Fluid Resistance	None
------------------	------

Operation/Application

Circuit Application	Power & Signal
---------------------	----------------

Shielded	No
----------	----

Industry Standards

UL Flammability Rating	UL 94V-0
------------------------	----------

VDE Tested	Yes
------------	-----

Packaging Features

Packaging Method	Package
------------------	---------

Packaging Quantity	100
--------------------	-----

Other

Comment	4 Locating Key Arrangement.
---------	-----------------------------

Product Compliance







[For compliance documentation, visit the product page on TE.com>](#)

EU RoHS Directive 2011/65/EU	Compliant
EU ELV Directive 2000/53/EC	Compliant
China RoHS 2 Directive MIIT Order No 32, 2016	No Restricted Materials Above Threshold
EU REACH Regulation (EC) No. 1907/2006	Current ECHA Candidate List: JUL 2021 (219) Candidate List Declared Against: JUL 2021 (219) Does not contain REACH SVHC
Halogen Content	Not Low Halogen - contains Br or Cl > 900 ppm.
Solder Process Capability	Not applicable for solder process capability

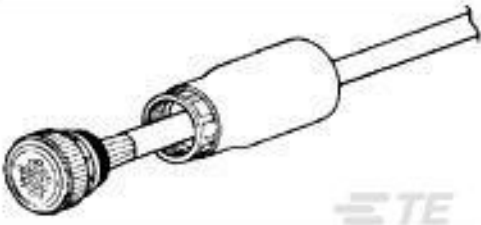
Product Compliance Disclaimer

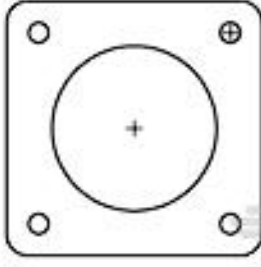
This information is provided based on reasonable inquiry of our suppliers and represents our current actual knowledge based on the information they provided. This information is subject to change. The part numbers that TE has identified as EU RoHS compliant have a maximum concentration of 0.1% by weight in homogenous materials for lead, hexavalent chromium, mercury, PBB, PBDE, DBP, BBP, DEHP, DIBP, and 0.01% for cadmium, or qualify for an exemption to these limits as defined in the Annexes of Directive 2011/65/EU (RoHS2). Finished electrical and electronic equipment products will be CE marked as required by Directive 2011/65/EU. Components may not be CE marked. Additionally, the part numbers that TE has identified as EU ELV compliant have a maximum concentration of 0.1% by weight in homogenous materials for lead, hexavalent chromium, and mercury, and 0.01% for cadmium, or qualify for an exemption to these limits as defined in the Annexes of Directive 2000/53/EC (ELV). Regarding the REACH Regulation, the information TE provides on SVHC in articles for this part number is based on the latest European Chemicals Agency (ECHA) 'Guidance on requirements for substances in articles' posted at this URL: <https://echa.europa.eu/guidance-documents/guidance-on-reach>

Compatible Parts

 <p>TE Part # 213868-1 23-19 RCPT HSG,REV SEX,CPC</p>	 <p>TE Part # 54012-1 CPC STRAIN RELIEF,SIZE 23</p>	 <p>TE Part # CAT-AM71-T98 TYPE II CONTACTS</p>	 <p>TE Part # 81665-5 ECONOSEAL, FLANGE GASKET</p>
 <p>TE Part # CAT-AM71-T98E TYPE III CONTACTS LP</p>	 <p>TE Part # CAT-AM71-T98D TYPE III CONTACTS LP EMEA</p>	 <p>TE Part # CAT-AM71-T98A TYPE III CONTACTS LP</p>	 <p>TE Part # CAT-AM71-T98G TYPE III CONTACTS LP HIGH CURRENT</p>



TE Part # CAT-AM71-T98B
TYPE III CONTACTS STRIP



TE Part # CAT-AM71-T98F
TYPE III CONTACTS STRIP HIGH CURRENT



TE Part # 207299-4
FLANGE PLUG



TE Part # CAT-AM71-C83998B
CPC CABLE CLAMPS



TE Part # 207446-3
SEALING CAP ASSY,SZ 23,CPC

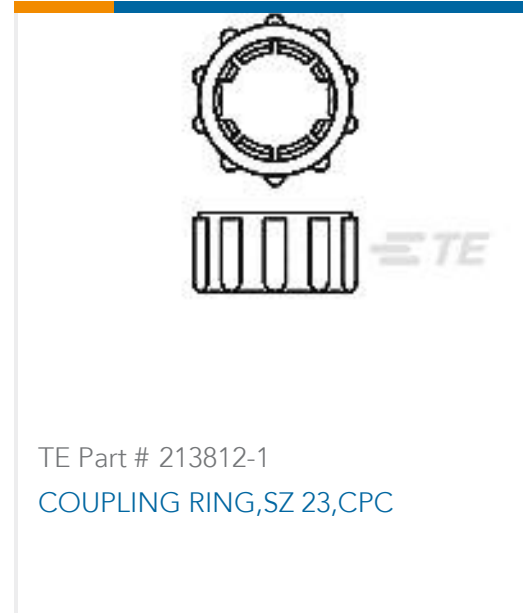

TE Part # 213812-1
COUPLING RING,SZ 23,CPC

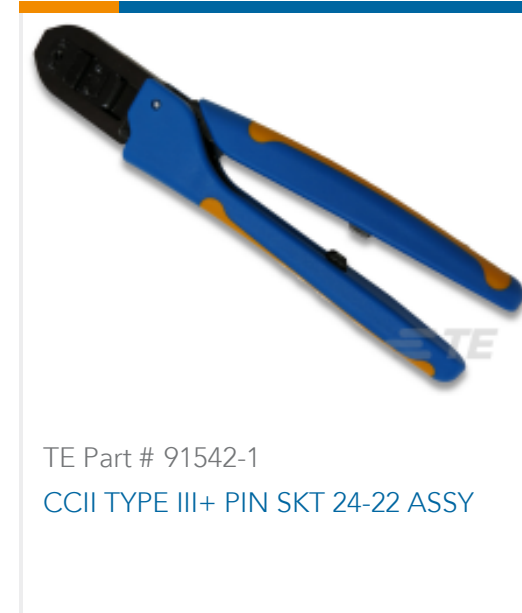

TE Part # 91542-1
CCII TYPE III+ PIN SKT 24-22 ASSY

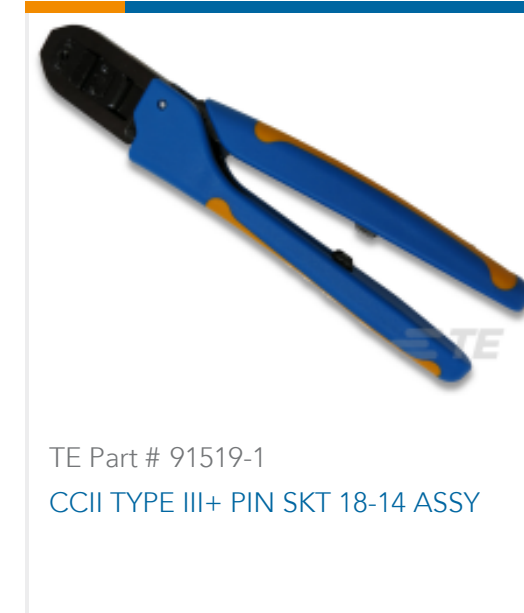

TE Part # 91519-1
CCII TYPE III+ PIN SKT 18-14 ASSY



TE Part # 91505-1
CCII TYPE III+ 24-16 ASSY



TE Part # 58495-1
PRO CRIMPER ASSY MULTIMATE



TE Part # 91523-1
CCII TYPE III+ PIN SKT 24-16 ASSY

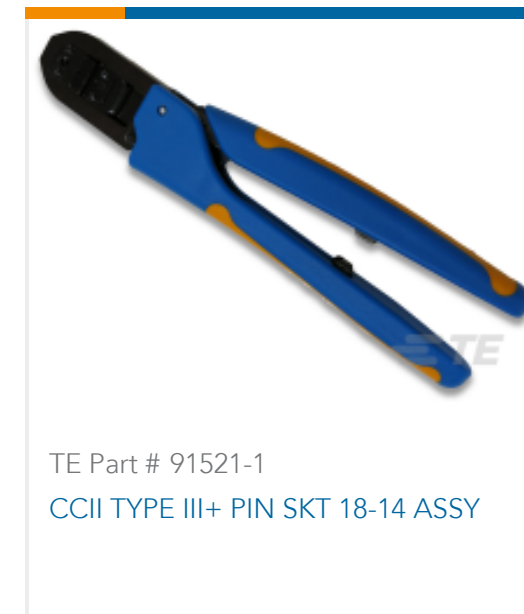

TE Part # 91521-1
CCII TYPE III+ PIN SKT 18-14 ASSY

Also in the Series | AMP CPC

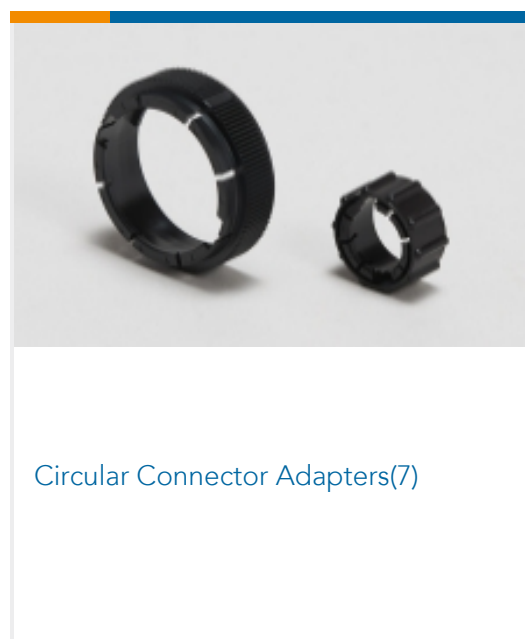

Circular Connector Adapters(7)

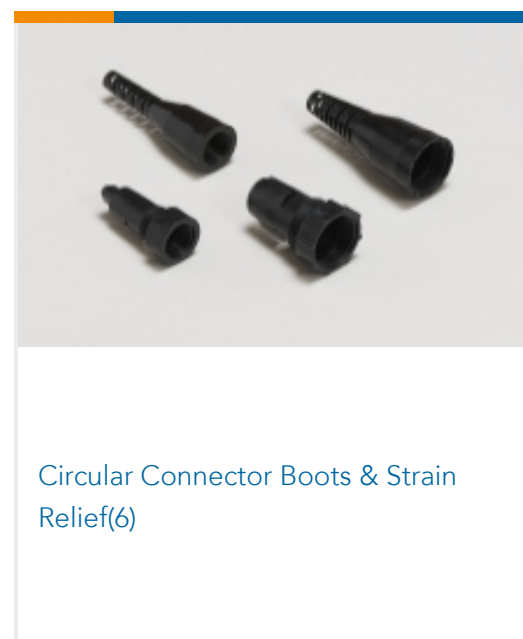

Circular Connector Boots & Strain Relief(6)

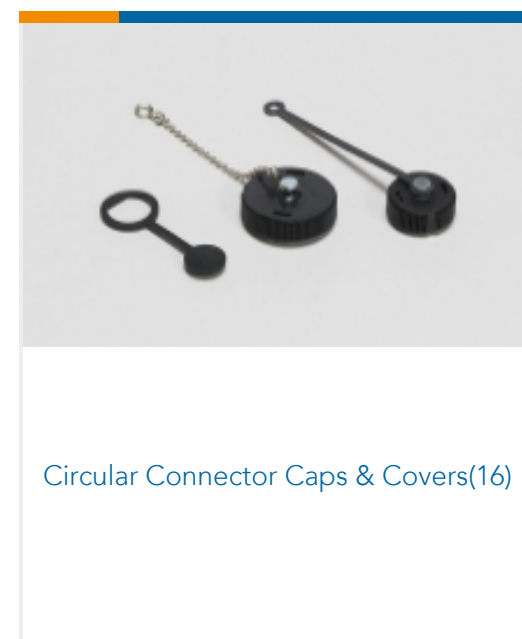

Circular Connector Caps & Covers(16)

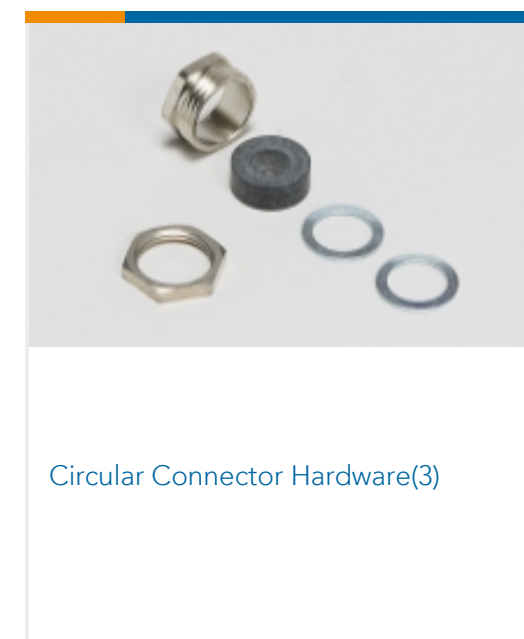

Circular Connector Hardware(3)

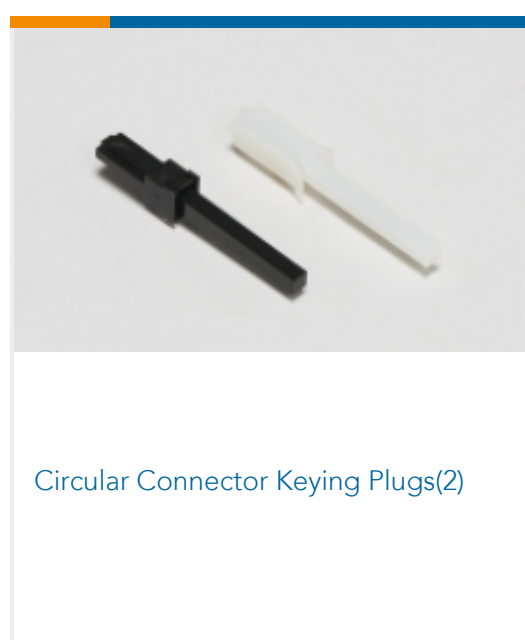

Circular Connector Keying Plugs(2)

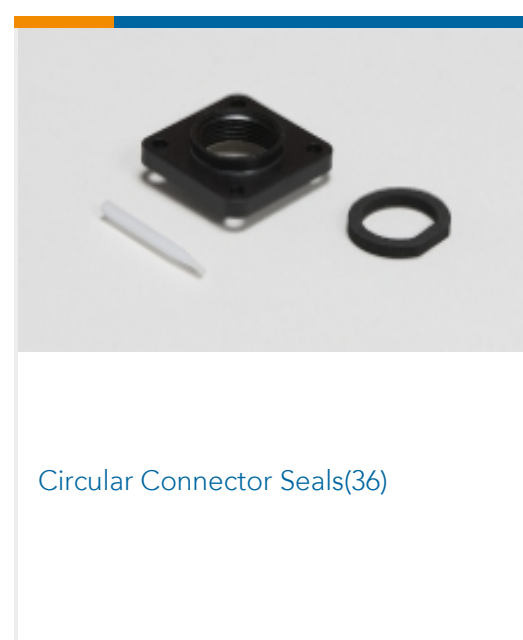

Circular Connector Seals(36)

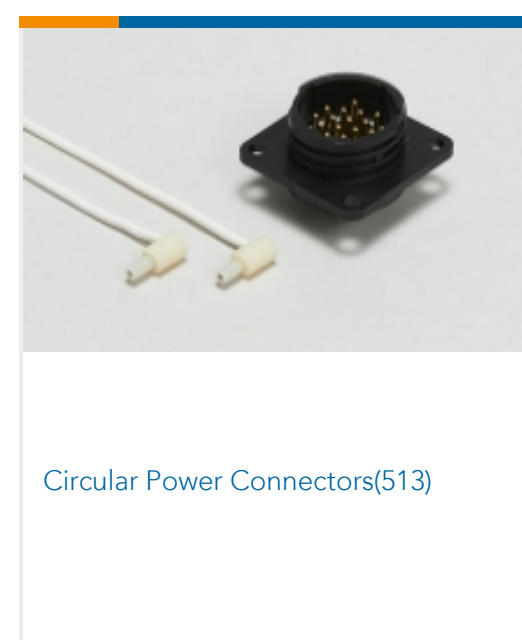

Circular Power Connectors(513)

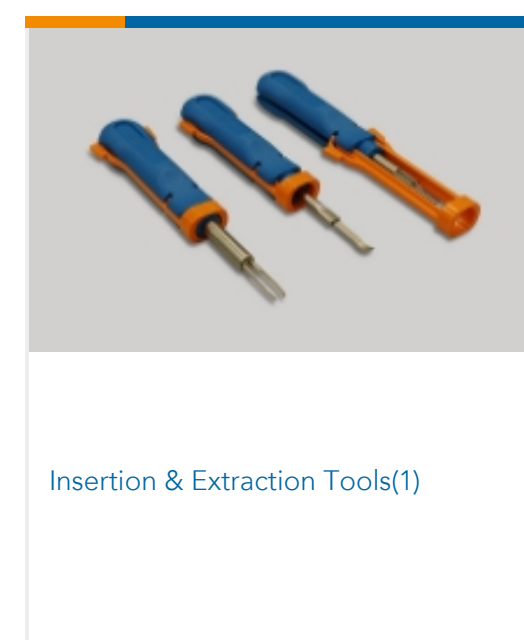

Insertion & Extraction Tools(1)

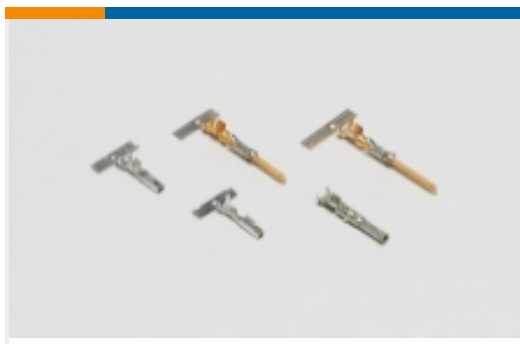

Power Contacts(6)

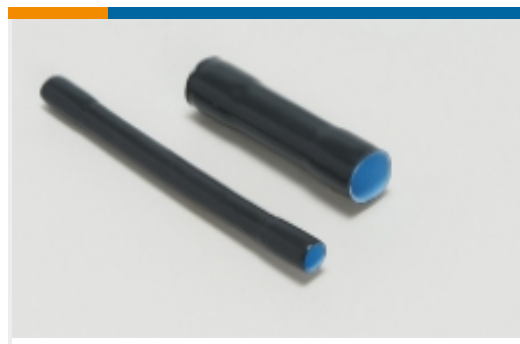

Sealing Sleeves(2)



Unscreened Circular Connector Backshells & Clamps(5)

Customers Also Bought



TE Part #213868-1
CPC SERIES 1



TE Part #1-66597-1
III+ PIN,18-14,TIN ,STRIP



TE Part #1-206138-0
CPC CABLE CLAMPS



TE Part #206305-4
CPC PLUG ASSEMBLY SIZE 23-37



TE Part #2-66358-1
III+SKT,18-14,TIN STRIP

Documents

Product Drawings

[CPC PLUG ASSEMBLY SIZE 23-19](#)

English

CAD Files

[3D PDF](#)

English

Customer View Model

[ENG_CVM_213852-1_B.2d_dxf.zip](#)

English

Customer View Model

[ENG_CVM_213852-1_B.3d_igs.zip](#)

English

Customer View Model

[ENG_CVM_213852-1_B.3d_stp.zip](#)

English

By downloading the CAD file I accept and agree to the [Terms and Conditions](#) of use.



Datasheets & Catalog Pages

[AMP Circular Connectors for Commercial Signal & Power Applications](#)

English

Product Specifications

[Application Specification](#)

English

Agency Approvals

[UL Report](#)

English