

211769-5  ACTIVE

AMP | AMP CPC

TE Internal #: 211769-5

AMP CPC, Circular Power Connectors, Housing, Operating Voltage 600 VDC, Wire-to-Wire, 9 Position, Wire & Cable, Receptacle, Reverse Gender, Socket

[View on TE.com >](#)



Connectors > Power Connectors > Circular Power > Circular Power Connectors



Connector Product Type: **Housing**

Operating Voltage: **600 VDC**

Connector System: **Wire-to-Wire**

Number of Positions: **9**

Sealable: **No**

## Features

### Product Type Features

Connector Product Type	Housing
Connector System	Wire-to-Wire
Sealable	No
Connector & Contact Terminates To	Wire & Cable
Connector & Housing Type	Receptacle
Circular Connector Shell Type	All Plastic

### Configuration Features

Reverse Numbering	Without
Number of Positions	9
Number of Power Positions	0
Keying	A
Number of Signal Positions	9

### Electrical Characteristics

Operating Voltage	600 VAC
-------------------	---------

### Contact Features

Reverse Gender	Yes
Contact Type	Socket
Contact Protection	With



### Mechanical Attachment

Panel Mount Feature Type	Flange with Threaded Inserts
Screw & Hole Thread Size	15/16-20 UNEF – 2A
Connector Mounting Type	Panel Mount
Mating Alignment	With
Mating Retention	With
Panel Mount Feature	With
Mating Alignment Type	Keyed
Mating Retention Type	Threaded Coupling

### Housing Features

Body Orientation	Straight
Housing Color	Black
Housing Material	Nylon, Thermoplastic
Circular Connector Shell Size	17

### Usage Conditions

Operating Temperature Range	-55 – 105 °C[-67 – 221 °F]
Fluid Resistance	None

### Operation/Application

Circuit Application	Power & Signal
Shielded	No

### Industry Standards

UL Flammability Rating	UL 94V-0
VDE Tested	Yes

### Packaging Features

Packaging Method	Package
Packaging Quantity	1

### Product Compliance

[For compliance documentation, visit the product page on TE.com>](#)

EU RoHS Directive 2011/65/EU	Compliant
EU ELV Directive 2000/53/EC	Compliant
China RoHS 2 Directive MIIT Order No 32, 2016	No Restricted Materials Above Threshold

EU REACH Regulation (EC) No. 1907/2006

Current ECHA Candidate List: JUL 2021 (219)

Candidate List Declared Against: JAN 2021 (211)

SVHC > Threshold:  
Not Yet Reviewed

Halogen Content

BFR/CFR/PVC Free, but Br/Cl >900 ppm in other sources.

Solder Process Capability

Not applicable for solder process capability

Product Compliance Disclaimer

This information is provided based on reasonable inquiry of our suppliers and represents our current actual knowledge based on the information they provided. This information is subject to change. The part numbers that TE has identified as EU RoHS compliant have a maximum concentration of 0.1% by weight in homogenous materials for lead, hexavalent chromium, mercury, PBB, PBDE, DBP, BBP, DEHP, DIBP, and 0.01% for cadmium, or qualify for an exemption to these limits as defined in the Annexes of Directive 2011/65/EU (RoHS2). Finished electrical and electronic equipment products will be CE marked as required by Directive 2011/65/EU. Components may not be CE marked. Additionally, the part numbers that TE has identified as EU ELV compliant have a maximum concentration of 0.1% by weight in homogenous materials for lead, hexavalent chromium, and mercury, and 0.01% for cadmium, or qualify for an exemption to these limits as defined in the Annexes of Directive 2000/53/EC (ELV). Regarding the REACH Regulation, the information TE provides on SVHC in articles for this part number is based on the latest European Chemicals Agency (ECHA) 'Guidance on requirements for substances in articles' posted at this URL: <https://echa.europa.eu/guidance-documents/guidance-on-reach>

## Compatible Parts



TE Part # 211768-1  
CPC PLUG ASSEMBLY SIZE 17-9

## Also in the Series | AMP CPC



Circular Connector Adapters(7)



Circular Connector Boots & Strain Relief(6)



Circular Connector Caps & Covers(16)



Circular Connector Hardware(3)



Circular Connector Keying Plugs(2)



Circular Connector Seals(36)



Circular Power Connectors(513)



Insertion & Extraction Tools(1)

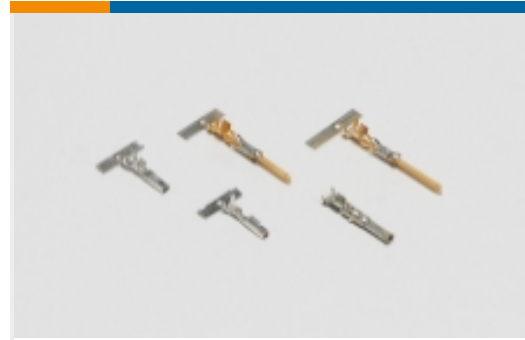

Power Contacts(6)

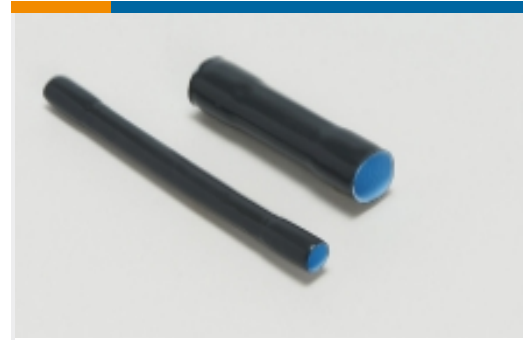

Sealing Sleeves(2)



Unscreened Circular Connector Backshells & Clamps(56)

## Customers Also Bought



TE Part #1658610-1  
37 POS HDF RCPT, MS, LEAD FREE



TE Part #206433-3  
CPC RCPT ASSEMBLY SIZE 11-8



TE Part #6-2271128-2  
M12, FEMALE, A CODE, R/A, 12P, PG9 (AU)

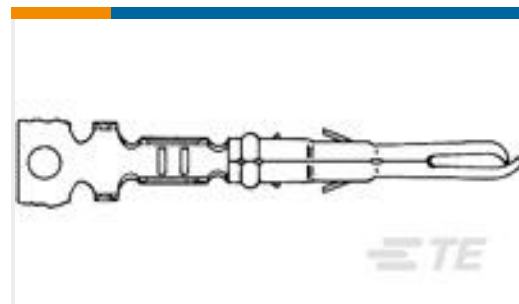

TE Part #350018-1  
058 PIN 26-18 008PTPBR



TE Part #5748270-2  
FEMALE SCREWLOCK,ZN PLTD



TE Part #193842-1  
SKT ASSY., 2MM, 12-14 AWG



TE Part #208130-1  
CPC RCPT ASSEMBLY SIZE 11-4

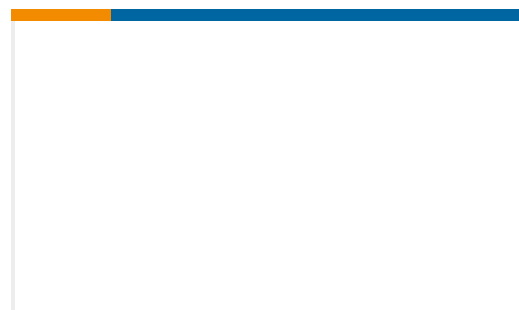

TE Part #350019-1  
MR REC CONTACT 26-16

## Documents

### Product Drawings

[17-9 CPC RECEPT REV SEX](#)

English

### CAD Files

[3D PDF](#)

3D

Customer View Model

[ENG\\_CVM\\_CVM\\_211769-5\\_AE.2d\\_dxf.zip](#)



English

Customer View Model

[ENG\\_CVM\\_CVM\\_211769-5\\_AE.3d\\_igs.zip](#)

English

Customer View Model

[ENG\\_CVM\\_CVM\\_211769-5\\_AE.3d\\_stp.zip](#)

English

By downloading the CAD file I accept and agree to the [Terms and Conditions](#) of use.

[Agency Approvals](#)

[UL Report](#)

English