

## Male header with straight solder pins; 2-pole; pin spacing 3.5 mm / 0.138 in

Item No.: 2091-1402



Male header with straight solder pins; 2-pole; pin spacing 3.5 mm / 0.138 in

### Marking

RoHS ✓  
Compliant

### Business data

Supplier	WAGO
Item no.	2091-1402
GTIN / EAN	4050821160991
Content	1
Order amount	200
Customer item number	

### Notes

Assembly of female connectors without loss of poles, allowing different functions to be divided within one male header Coding pins inserted into the header interface prevent mismating, allowing subsequent coding in panel feedthrough applications The female connector is fully shrouded by the male header's housing, providing vibration resistance up to 20 g

### Technical data

#### Miscellaneous

No. of poles	2
Pin Spacing	3.5 mm (0.0 in %)
Color	light gray
Ratings according to 1	IEC/EN 60664-1
Overvoltage category EN 1	III
Pollution degree (1)	2

<b>Technical data</b>	
<i>Rated voltage EN (1) [V]</i>	160 [V]
<i>Rated surge voltage (1) [kV]</i>	2.5 [kV]
<i>Nominal current [A]</i>	10 [A]
<i>Overvoltage category EN 2</i>	II
<i>Degree of pollution (2)</i>	2
<i>Rated voltage EN (2) [V]</i>	320 [V]
<i>Rated surge voltage (2) [kV]</i>	2.5 [kV]
<i>Nominal current (2) [A]</i>	10 [A]
<i>Overvoltage category EN 3</i>	III
<i>Degree of pollution (3)</i>	3
<i>Rated voltage EN (3) [V]</i>	160 [V]
<i>Rated surge voltage (3) [kV]</i>	2.5 [kV]
<i>Nominal current (3) [A]</i>	10 [A]
<i>Solder pin length [mm]</i>	3.6 [mm]
<i>Solder pin diameter [mm]</i>	1 [mm]
<i>Tolerance of drilled hole [mm]</i>	1.2(+ 0.1) [mm]
<i>Material group</i>	I
<i>Insulating material</i>	Polyphthalamid (PPA GF)
<i>Flammability rating per UL 94</i>	V0
<i>Limit temperature range</i>	-60 C ... 100 C
<i>Contact material</i>	Electrolytic copper (Ecu)
<i>Contact plating</i>	tin-plated
<i>Fire load [MJ]</i>	0.022 [MJ]
<i>Weight [g]</i>	0.93 [g]
<i>Width</i>	9 mm / 0.354 in
<i>Height</i>	21.1 mm / 0.831 in
<i>Height from the surface</i>	17.5 mm / 0.689 in
<i>Length</i>	12.4 mm / 0.488 in

Images & drawings



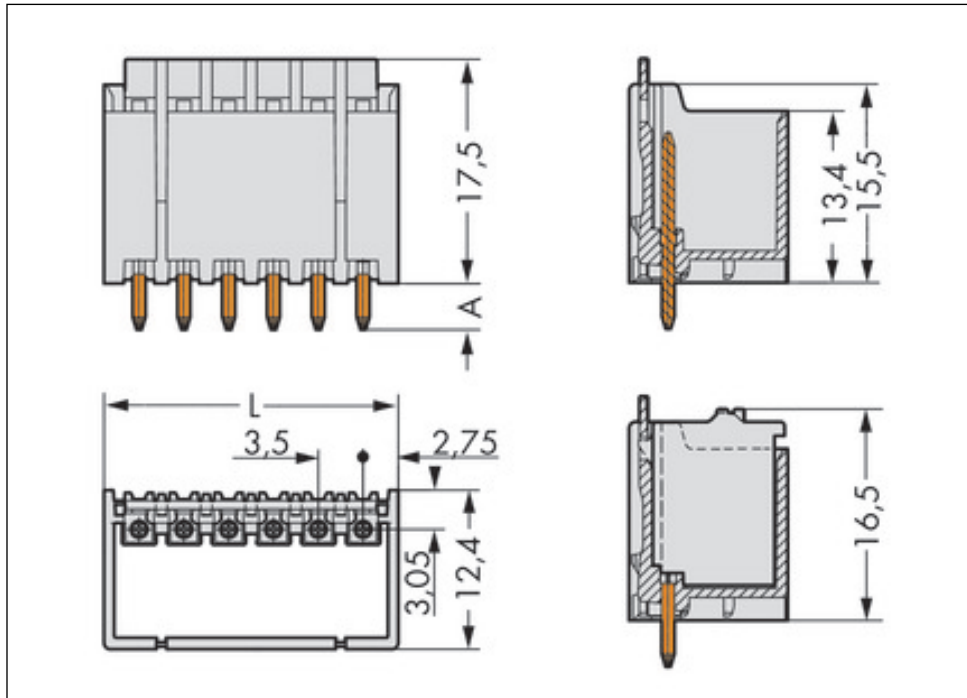

#### Address

WAGO Kontakttechnik GmbH & Co. KG

Hansastr. 27

32423 Minden

Telefon: 0571/887-0

Fax: 0571/887-169

<http://www.wago.com>

© WAGO Kontakttechnik GmbH & Co. KG

Technische Änderungen und Irrtümer vorbehalten.