

Data sheet | Item number: 2086-1230

THR PCB terminal block; push-button; 1.5 mm<sup>2</sup>; Pin spacing 3.5 mm; 10-pole;  
Push-in CAGE CLAMP®; 1,50 mm<sup>2</sup>; black

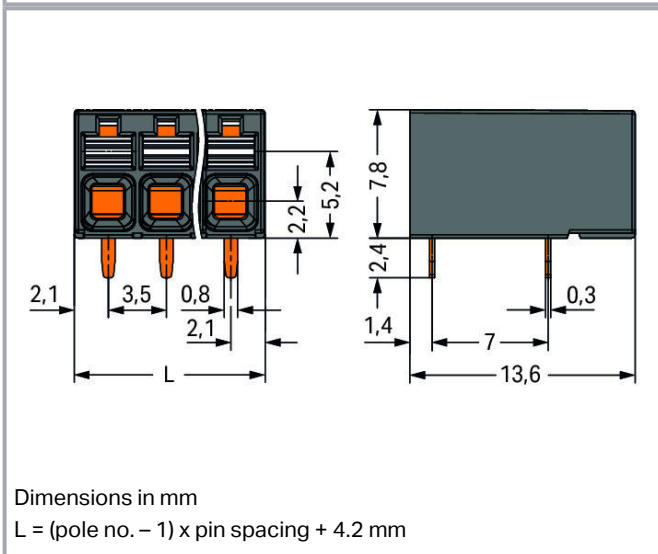

[www.wago.com/2086-1230](http://www.wago.com/2086-1230)

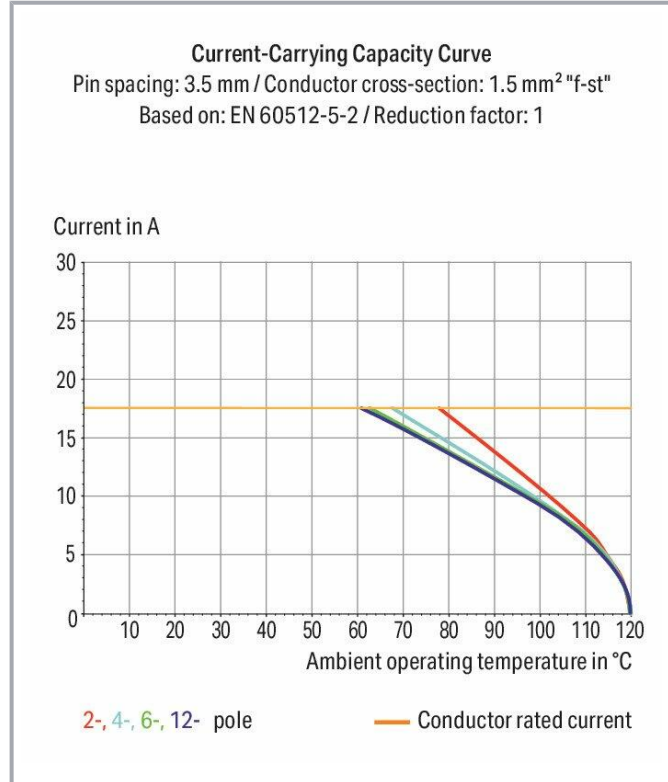
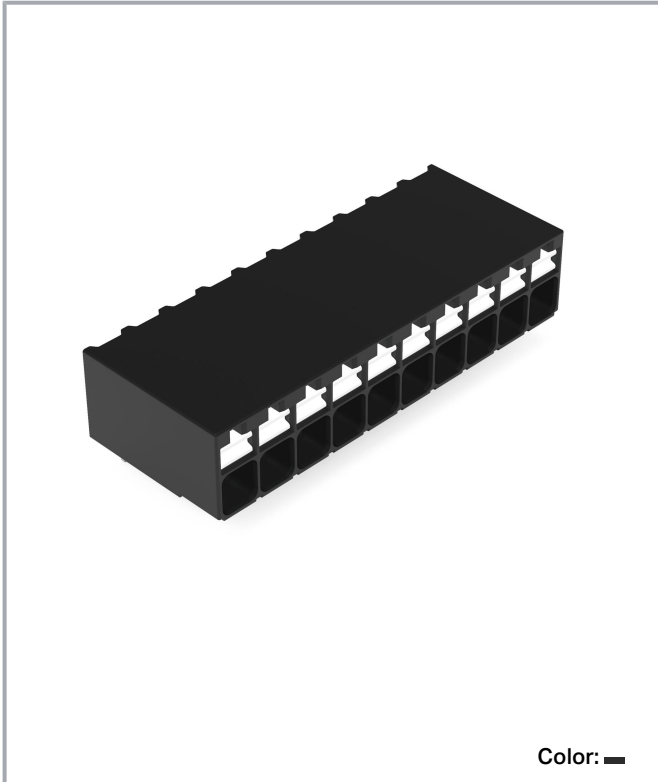

Subject to changes. Please also observe the further product documentation!

WAGO Kontakttechnik GmbH & Co. KG  
Hansastr. 27  
32423 Minden  
Phone: +49571 887-0 | Fax: +49571 887-169  
Email: [info.de@wago.com](mailto:info.de@wago.com) | Web: [www.wago.com](http://www.wago.com)

Do you have any questions about our products?  
We are always happy to take your call at 01788 568 008.

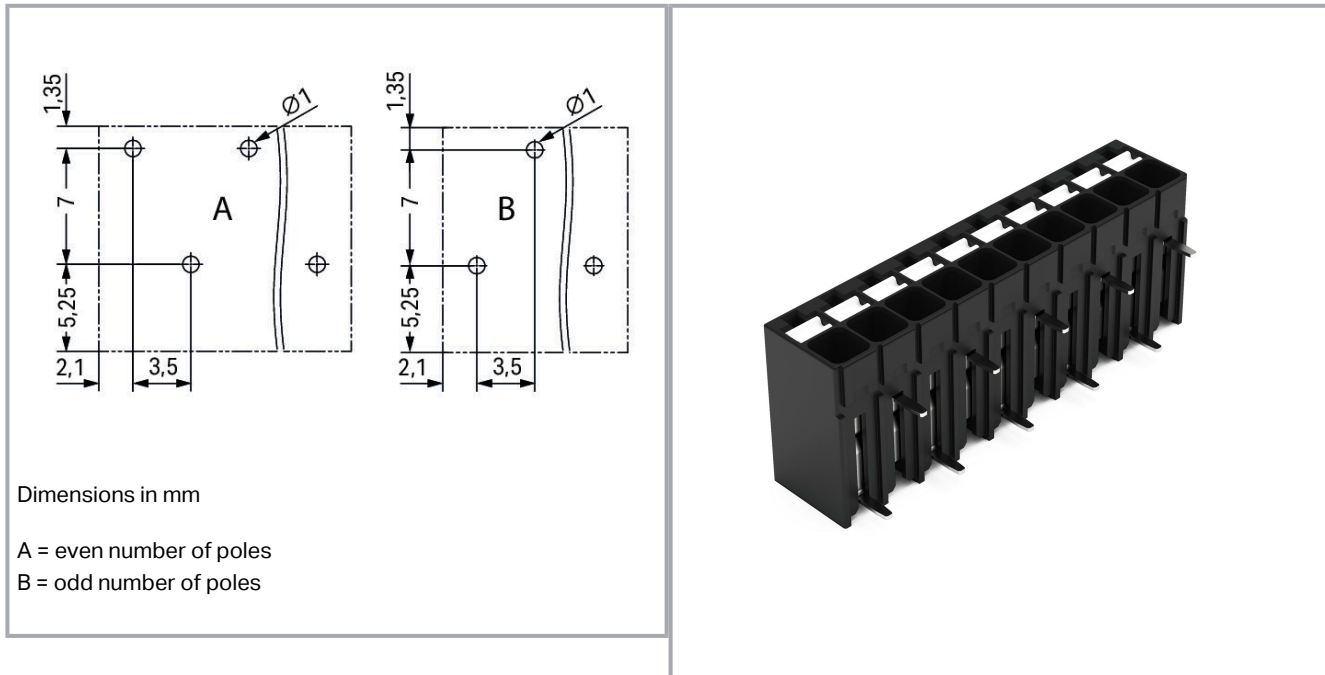

## Item description

- Ideal for compact device connection, panel feedthrough and tight spaces
- Push-in CAGE CLAMP® allows push-in termination of solid and fine-stranded conductors with ferrules
- SMD and THR variants available
- Delivery in tape-and-reel packaging for full integration into SMT soldering process
- Push-button moves in direction of conductor connection
- Conductor connection and mating direction both parallel and perpendicular to the PCB
- Choice of double pin spacing or alternating pin spacing, 3.5 and 5 mm pin spacing

## Data

### Electrical data

### Ratings per IEC/EN

| Ratings per                 | IEC/EN 60664-1 |
|-----------------------------|----------------|
| Nominal voltage (III/3)     | 250 V          |
| Rated surge voltage (III/3) | 4 kV           |
| Rated voltage (III/2)       | 320 V          |
| Rated surge voltage (III/2) | 4 kV           |
| Nominal voltage (II/2)      | 630 V          |

Subject to changes. Please also observe the further product documentation!

WAGO Kontakttechnik GmbH & Co. KG  
Hansastr. 27  
32423 Minden  
Phone: +49571 887-0 | Fax: +49571 887-169  
Email: [info.de@wago.com](mailto:info.de@wago.com) | Web: [www.wago.com](http://www.wago.com)

Do you have any questions about our products?  
We are always happy to take your call at 01788 568 008.

|                            |   |
|----------------------------|---|
| Rated surge voltage (II/2) | 4 kV  |
| Rated current              | 17.5 A  |
| Legend (ratings)           | (III / 2) $\hat{=}$ Overvoltage category III / Pollution degree 2 |

### Ratings per UL

|                                |         |
|--------------------------------|---------|
| Approvals per                  | UL 1059 |
| Rated voltage UL (Use Group B) | 300 V   |
| Rated current UL (Use Group B) | 10 A    |
| Rated voltage UL (Use Group C) | 300 V   |
| Rated current UL (Use Group C) | 10 A    |
| Rated voltage UL (Use Group D) | 300 V   |
| Rated current UL (Use Group D) | 10 A    |

### Ratings per CSA

|                                 |       |
|---------------------------------|-------|
| Approvals per                   | CSA   |
| Rated voltage CSA (Use Group B) | 300 V |
| Rated current CSA (Use Group B) | 10 A  |
| Rated voltage CSA (Use Group D) | 300 V |
| Rated current CSA (Use Group D) | 10 A  |

### Connection data

|                            |    |
|----------------------------|----|
| Total number of potentials | 10 |
| Number of connection types | 1  |
| Number of levels           | 1  |

### Connection 1

|   |  |
|---|--|
| Connection technology                             | Push-in CAGE CLAMP®                          |
| Actuation type                                    | Push-button                                  |
| Solid conductor                                   | 0.14 ... 1.5 mm <sup>2</sup> / 24 ... 16 AWG |
| Fine-stranded conductor                           | 0.14 ... 1.5 mm <sup>2</sup> / 24 ... 16 AWG |
| Fine-stranded conductor; with insulated ferrule   | 0.25 ... 0.75 mm <sup>2</sup>                |
| Fine-stranded conductor; with uninsulated ferrule | 0.25 ... 1.5 mm <sup>2</sup>                 |
| Conductor diameter                                | 24 ... 16 AWG                                |
| Strip length                                      | 8 ... 9 mm / 0.31 ... 0.35 inch              |
| Conductor connection direction to PCB             | 0°   |
| Pole No.  | 10   |

Subject to changes. Please also observe the further product documentation!



## Physical data

|                                    |                        |
|------------------------------------|------------------------|
| Pin spacing                        | 3.5 mm / 0.138 inch    |
| Width                              | 37.7 mm / 1.406 inch   |
| Height                             | 10.2 mm / 0.402 inch   |
| Height from the surface            | 7.8 mm / 0.307 inch    |
| Depth                              | 13.6 mm / 0.535 inch   |
| Solder pin length                  | 2.4 mm                 |
| Solder pin dimensions              | 0.3 x 0.8 mm           |
| Plated through-hole diameter (THR) | 1 <sup>(+0.1)</sup> mm |

## PCB contact

|                                     |  |
|-------------------------------------|--|
| PCB Contact                         | THR  |
| Solder pin arrangement              | over the entire terminal strip (staggered) |
| Number of solder pins per potential | 1  |

## Material data

|                             |  |
|-----------------------------|--|
| Color                       | black                                  |
| Insulation material         | Polyphthalamide (PPA GF)               |
| Flammability class per UL94 | V0                                     |
| Clamping spring material    | Chrome nickel spring steel (CrNi)      |
| Contact material            | Electrolytic copper (E <sub>Cu</sub> ) |
| Contact plating             | tin-plated                             |
| Weight                      | 4.8 g                                  |

## Environmental requirements

|                         |                 |
|-------------------------|-----------------|
| Limit temperature range | -60 ... +105 °C |
|-------------------------|-----------------|

## Commercial data

|                       |               |
|-----------------------|---------------|
| PU (SPU)              | 84 Stück      |
| Packaging type        | BOX           |
| Country of origin     | CH            |
| GTIN                  | 4055144089097 |
| Customs tariff number | 85369010000   |



## Approvals / Certificates

Subject to changes. Please also observe the further product documentation!

WAGO Kontakttechnik GmbH & Co. KG  
 Hansastr. 27  
 32423 Minden  
 Phone: +49571 887-0 | Fax: +49571 887-169  
 Email: [info.de@wago.com](mailto:info.de@wago.com) | Web: [www.wago.com](http://www.wago.com)

Do you have any questions about our products?  
 We are always happy to take your call at 01788 568 008.









## Country specific Approvals

| Logo   | Approval                                     | Additional Approval Text | Certificate name |
|--|--|--------------------------|------------------|
|  | <b>CB</b><br>DEKRA Certification B.V.        | IEC 60947-7-4            | NL-74022         |
|  | <b>CSA</b><br>DEKRA Certification B.V.       | C22.2                    | 80060692         |
|  | <b>KEMA/KEUR</b><br>DEKRA Certification B.V. | EN 60947-7-4             | 71-<br>119449    |

## Optional accessories



| Ferrule   |  |  |
|---|--|--|
| Ferrule   |  |  |
|    | <b>Item no.: 216-101</b><br>Ferrule; Sleeve for 0.5 mm <sup>2</sup> / AWG 22; uninsulated; electro-tin plated; silver-colored  | <a href="http://www.wago.com/216-101">www.wago.com/216-101</a> |
|   | <b>Item no.: 216-104</b><br>Ferrule; Sleeve for 1.5 mm <sup>2</sup> / AWG 16; uninsulated; electro-tin plated; silver-colored  | <a href="http://www.wago.com/216-104">www.wago.com/216-104</a> |
|  | <b>Item no.: 216-102</b><br>Ferrule; Sleeve for 0.75 mm <sup>2</sup> / AWG 20; uninsulated; electro-tin plated; silver-colored   | <a href="http://www.wago.com/216-102">www.wago.com/216-102</a> |
|  | <b>Item no.: 216-103</b><br>Ferrule; Sleeve for 1 mm <sup>2</sup> / AWG 18; uninsulated; electro-tin plated  | <a href="http://www.wago.com/216-103">www.wago.com/216-103</a> |
|  | <b>Item no.: 216-142</b><br>Ferrule; Sleeve for 0.75 mm <sup>2</sup> / 18 AWG; uninsulated; electro-tin plated; electrolytic copper; gastight crimped; acc. to DIN 46228, Part 1/08.92 | <a href="http://www.wago.com/216-142">www.wago.com/216-142</a> |
|  | <b>Item no.: 216-132</b><br>Ferrule; Sleeve for 0.34 mm <sup>2</sup> / AWG 24; uninsulated; electro-tin plated   | <a href="http://www.wago.com/216-132">www.wago.com/216-132</a> |
|  | <b>Item no.: 216-121</b><br>Ferrule; Sleeve for 0.5 mm <sup>2</sup> / AWG 22; uninsulated; electro-tin plated; silver-colored  | <a href="http://www.wago.com/216-121">www.wago.com/216-121</a> |
|  | <b>Item no.: 216-143</b><br>Ferrule; Sleeve for 1 mm <sup>2</sup> / AWG 18; uninsulated; electro-tin plated; electrolytic copper; gastight crimped; acc. to DIN 46228, Part 1/08.92    | <a href="http://www.wago.com/216-143">www.wago.com/216-143</a> |
|  | <b>Item no.: 216-131</b><br>Ferrule; Sleeve for 0.25 mm <sup>2</sup> / AWG 24; uninsulated; electro-tin plated; silver-colored   | <a href="http://www.wago.com/216-131">www.wago.com/216-131</a> |
|  | <b>Item no.: 216-141</b><br>Ferrule; Sleeve for 0.5 mm <sup>2</sup> / 20 AWG; uninsulated; electro-tin plated; electrolytic copper; gastight crimped; acc. to DIN 46228, Part 1/08.92  | <a href="http://www.wago.com/216-141">www.wago.com/216-141</a> |

Subject to changes. Please also observe the further product documentation!

|   |   |  |
|---|---|--|
|  | <b>Item no.: 216-152</b><br>Ferrule; Sleeve for 0.34 mm <sup>2</sup> / AWG 24; uninsulated; electro-tin plated  | <a href="http://www.wago.com/216-152">www.wago.com/216-152</a> |
|  | <b>Item no.: 216-202</b><br>Ferrule; Sleeve for 0.75 mm <sup>2</sup> / 18 AWG; insulated; electro-tin plated; gray  | <a href="http://www.wago.com/216-202">www.wago.com/216-202</a> |
|  | <b>Item no.: 216-151</b><br>Ferrule; Sleeve for 0.25 mm <sup>2</sup> / AWG 24; uninsulated; electro-tin plated  | <a href="http://www.wago.com/216-151">www.wago.com/216-151</a> |
|  | <b>Item no.: 216-144</b><br>Ferrule; Sleeve for 1.5 mm <sup>2</sup> / AWG 16; uninsulated; electro-tin plated; electrolytic copper; gastight crimped; acc. to DIN 46228, Part 1/08.92; silver-colored | <a href="http://www.wago.com/216-144">www.wago.com/216-144</a> |
|  | <b>Item no.: 216-201</b><br>Ferrule; Sleeve for 0.5 mm <sup>2</sup> / 20 AWG; insulated; electro-tin plated; white  | <a href="http://www.wago.com/216-201">www.wago.com/216-201</a> |
|  | <b>Item no.: 216-241</b><br>Ferrule; Sleeve for 0.5 mm <sup>2</sup> / 20 AWG; insulated; electro-tin plated; electrolytic copper; gastight crimped; acc. to DIN 46228, Part 4/09.90; white            | <a href="http://www.wago.com/216-241">www.wago.com/216-241</a> |
|  | <b>Item no.: 216-242</b><br>Ferrule; Sleeve for 0.75 mm <sup>2</sup> / 18 AWG; insulated; electro-tin plated; electrolytic copper; gastight crimped; acc. to DIN 46228, Part 4/09.90; gray            | <a href="http://www.wago.com/216-242">www.wago.com/216-242</a> |
|  | <b>Item no.: 216-301</b><br>Ferrule; Sleeve for 0.25 mm <sup>2</sup> / AWG 24; insulated; electro-tin plated; yellow  | <a href="http://www.wago.com/216-301">www.wago.com/216-301</a> |
|  | <b>Item no.: 216-302</b><br>Ferrule; Sleeve for 0.34 mm <sup>2</sup> / 22 AWG; insulated; electro-tin plated; green   | <a href="http://www.wago.com/216-302">www.wago.com/216-302</a> |

### Testing and measuring

#### Testing accessories

|  |  |  |
|--|--|--|
|  | <b>Item no.: 735-500</b><br>Test pin; 1 mm Ø; with solder connection for test wire | <a href="http://www.wago.com/735-500">www.wago.com/735-500</a> |
|  | <b>Item no.: 859-500</b><br>Test pin; 1 mm Ø; with solder connection for test wire | <a href="http://www.wago.com/859-500">www.wago.com/859-500</a> |

### Tool

#### Operating tool

|  |   |  |
|--|---|--|
|  | <b>Item no.: 210-719</b><br>Operating tool; Blade: 2.5 x 0.4 mm; with a partially insulated shaft | <a href="http://www.wago.com/210-719">www.wago.com/210-719</a> |
|--|---|--|

### Downloads

#### Documentation

#### Additional Information

|                        |             |                 |          |
|------------------------|-------------|-----------------|----------|
| Technical explanations | Apr 3, 2019 | pdf<br>2.0 MB   | Download |
| THR Soldering Process  |             | pdf<br>548.2 kB | Download |

Subject to changes. Please also observe the further product documentation!

## CAD/CAE-Data

### CAD data

|                        |                     |                          |
|------------------------|---------------------|--------------------------|
| 2D/3D Models 2086-1230 | <a href="#">URL</a> | <a href="#">Download</a> |
|------------------------|---------------------|--------------------------|

### CAE data

|                        |                     |                          |
|------------------------|---------------------|--------------------------|
| ZUKEN Portal 2086-1230 | <a href="#">URL</a> | <a href="#">Download</a> |
|------------------------|---------------------|--------------------------|

## Environmental Product Compliance

### Compliance Search

|  |                     |                          |
|--|---------------------|--------------------------|
| Environmental Product Compliance 2086-1230 | <a href="#">URL</a> | <a href="#">Download</a> |
|--|---------------------|--------------------------|

THR PCB terminal block; push-button; 1.5 mm<sup>2</sup>; Pin spacing 3.5 mm; 10-pole; Push-in CAGE CLAMP®; 1,50 mm<sup>2</sup>; black

## Installation Notes

### Conductor termination



Inserting solid conductor via push-in termination.

### Conductor removal

Subject to changes. Please also observe the further product documentation!



Removing fine-stranded conductors via push-buttons.

#### Conductor termination

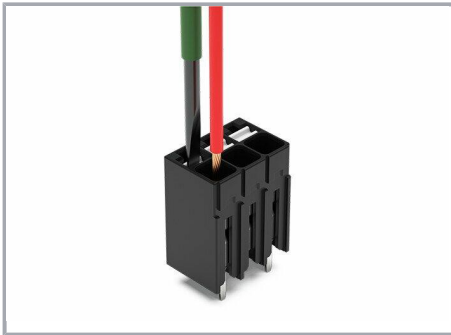

Inserting and removing fine-stranded conductors via push-buttons.

#### Testing



Testing via 1 mm Ø test pin.

Touch contact with current bar.

#### Marking

Subject to changes. Please also observe the further product documentation!



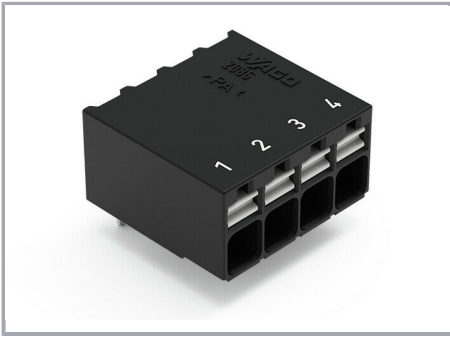

Pole marking via direct marking  
perpendicular to conductor entry.

Subject to changes. Please also observe the further product documentation!