



Volume 11: Vehicle and Commercial Controls

EATON

Powering Business Worldwide

Dimensions, Weights and Ratings

Dimensions, weights and ratings given in this catalog **are approximate and should not be used for construction purposes**. Drawings containing exact dimensions are available upon request. All listed product specifications and ratings are subject to change without notice. Photographs are representative of production units.

Terms and Conditions

All prices and discounts are subject to change without notice. When price changes occur, they are published in Eaton's *Price and Availability Digest* (PAD). All orders accepted by Eaton's Electrical Sector are subject to the general terms and conditions as set forth in Appendix 1—Eaton Terms & Conditions.

Technical and Descriptive Publications

This catalog contains brief technical data for proper selection of products. Further information is available in the form of technical information publications and illustrated brochures. If additional product information is required, contact your local Eaton Products Distributor, call **1-800-525-2000** or visit our website at **www.eaton.com**.

Compliance with Nuclear Regulation 10 CFR 21

Eaton products are sold as commercial grade products not intended for application in facilities or activities licensed by the United States Nuclear Regulatory Commission for atomic purposes, under 10 CFR 21. Further certification will be required for use of these products in a safety-related application in any nuclear facility licensed by the U.S. Nuclear Regulatory Commission.

WARNING

The installation and use of Eaton products should be in accordance with the provisions of the U.S. National Electrical Code® and/or other local codes or industry standards that are pertinent to the particular end use. Installation or use not in accordance with these codes and standards could be hazardous to personnel and/or equipment.

These catalog pages do not purport to cover all details or variations in equipment, nor to provide for every possible contingency to be met in connection with installation, operation or maintenance. Should further information be desired or should particular problems arise which are not covered sufficiently for the purchaser's purposes, the matter should be referred to the local Eaton Products Distributor or Sales Office. The contents of this catalog shall not become part of or modify any prior or existing agreement, commitment or relationship. The sales contract contains the entire obligation of Eaton's Electrical Sector. The warranty contained in the contract between the parties is the sole warranty of Eaton. Any statements contained herein do not create new warranties or modify the existing warranty.



Powering Business Worldwide

Eaton is a global leader in power distribution, power quality, control and automation, and monitoring products.

At Eaton, we believe a reliable, efficient and safe power system is the foundation of every successful enterprise. Through innovative technologies, cutting-edge products and our highly skilled services team, we empower businesses around the world to achieve a powerful advantage.

In addition, Eaton is committed to creating and maintaining powerful customer relationships built on a foundation of excellence. From the products we manufacture to our dedicated customer service and support, we know what's important to you.

Solutions

Eaton takes the complexity out of power systems management with a holistic and strategic approach, leveraging our industry-leading technology, solutions and services. We focus on the following three areas in all we do:

- Reliability—maintain the appropriate level of power continuity without disruption or unexpected downtime
- Efficiency—minimize energy usage, operating costs, equipment footprint and environmental impact
- Safety—identify and mitigate electrical hazards to protect what you value most

Using the Eaton Catalog Library

As we grow, it becomes increasingly difficult to include all products in one or two comprehensive catalogs. Knowing that each user has their specific needs, we have created a library of catalogs for our products that when complete, will contain 15 volumes. Since the volumes will continuously be a work in progress and updated, each volume will stand alone. Refer to our volume directory, MZ08100001E, for a quick glance of where to look for the products you need. The 15 volumes include:

- Volume 1—Residential and Light Commercial (CA08100002E)
- Volume 2—Commercial Distribution (CA08100003E)
- Volume 3—Power Distribution and Control Assemblies (CA08100004E)
- Volume 4—Circuit Protection (CA08100005E)
- Volume 5—Motor Control and Protection (CA08100006E)
- Volume 6—Solid-State Motor Control (CA08100007E)
- Volume 7—Logic Control, Operator Interface and Connectivity Solutions (CA08100008E)
- Volume 8—Sensing Solutions (CA08100010E)
- Volume 9—Original Equipment Manufacturer (CA08100011E)
- Volume 10—Enclosed Control (CA08100012E)
- Volume 11—Vehicle and Commercial Controls (CA08100013E)
- Volume 12—Aftermarket, Renewal Parts and Life Extension Solutions (CA08100014E)
- Volume 13—Counters, Timers and Tachometers (CA08100015E)—Available in electronic format only
- Volume 14—Fuses (CA08100016E)—Available in electronic format only
- Volume 15—Solar Inverters and Electrical Balance of System (CA08100018E)

These volumes are not all-inclusive of every product, but they are meant to be an overview of our product lines. For our full range of product solutions and additional product information, consult Eaton.com/electrical and other catalogs and product guides in our literature library. These references include:

- The Consulting Application Guide (CA08104001E)
- The Eaton Power Quality Product Guide (COR01FYA)

If you don't have the volume that contains the product or information that you are looking for, not to worry. You can access every volume of the catalog library at Eaton.com/electrical in the Literature Library.

By installing our Automatic Tab Updater (ATU), you can be sure you always have the most recent version of each volume and tab.

Contact Us

If you need additional help, you can find contact information under the Customer Care heading of Eaton.com/electrical.

Product Selection Guide



TAB 1—Electronic Products

Description	Page
E31 eSM	V11-T1-2
E30 eSM	V11-T1-7
E32 eSM	V11-T1-10
E33 eSM	V11-T1-14
eVu	V11-T1-17



TAB 2—Rockers

Description	Page
Introduction	V11-T2-2
NGR	V11-T2-8
SVR	V11-T2-32
Dual Motion Safety Switch	V11-T2-43
1500/2500	V11-T2-45
1600/2600	V11-T2-49
Rockette	V11-T2-56
8006/8007—EURO SR	V11-T2-64
8004/8005 Euro Full-Size	V11-T2-67
X Series	V11-T2-70
8064/8065 ESPORT	V11-T2-74
Accessories	V11-T2-78
Technical Data	V11-T2-80
Symbol Library	V11-T2-82



TAB 3—Special Devices

Description	Page
High Capacity Switches	V11-T3-2
Panelboard Switches	V11-T3-3
Keylock Switches, General Purpose/Heavy Duty—AC/DC Rated	V11-T3-5
Locking Rocker	V11-T3-9



TAB 4—Toggle Switches

Description	Page
Introduction	V11-T4-2
Military Purpose Toggles	V11-T4-3
Illuminated AC Rated Toggles	V11-T4-9
General Purpose Toggles—AC Rated	V11-T4-11
General Purpose Toggles—AC/DC Rated	V11-T4-20
X Series Toggles	V11-T4-24
Heavy Duty Hesitation Switches	V11-T4-27
Accessories	V11-T4-31
Technical Data	V11-T4-35



TAB 5—Dimmers and Wipers

Description	Page
Paddle and Slide Controls	V11-T5-2
Rotary Wipers	V11-T5-4



TAB 6—Pushbuttons

Description	Page
AC Rated	V11-T6-2
Illuminated AC/DC Rated	V11-T6-8
XP Series Sealed Pushbutton	V11-T6-21

TAB 7—Definitions and Index

Description	Page
Definitions	V11-T7-1
Index	V11-T7-2

E31 eSM—Multiplexed Keypad



E30 eSM—Multiplexed Rockers



E32 eSM—Multiplexed Rockers



E33 eSM—Sealed Multiplex Rocker Switch Units



eVu—Electronic Vehicle Display



1.1 E31 eSM—Keypad Multiplexed Switch Module	
Product Description	V11-T1-2
Application Description	V11-T1-2
Features and Benefits	V11-T1-2
Catalog Number Selection	V11-T1-3
Product Selection	V11-T1-4
Technical Data and Specifications	V11-T1-5
Dimensions	V11-T1-5
1.2 E30 eSM—Multiplexed Rocker Switch Units	
Product Description	V11-T1-7
Application Description	V11-T1-7
Product Selection	V11-T1-7
Technical Data and Specifications	V11-T1-8
Wiring	V11-T1-9
Dimensions	V11-T1-9
1.3 E32 eSM—Multiplexed Rocker Switch Units	
Product Description	V11-T1-10
Application Description	V11-T1-10
Features and Benefits	V11-T1-10
Product Selection	V11-T1-11
Accessories	V11-T1-11
Wiring	V11-T1-12
Dimensions	V11-T1-13
1.4 E33 eSM—Sealed Multiplexed Rocker Switch Units	
Product Description	V11-T1-14
Application Description	V11-T1-14
Features and Benefits	V11-T1-14
Product Selection	V11-T1-15
Wiring	V11-T1-15
Technical Data and Specifications	V11-T1-15
Dimensions	V11-T1-16
1.5 eVu—Electronic Vehicle Display	
Product Description	V11-T1-17
Application Description	V11-T1-17
Features	V11-T1-17
Product Selection	V11-T1-17
Dimensions	V11-T1-17

E31 eSM—Keypad Multiplexed Switch Module



Product Description

Because your vehicle is continuously exposed to nature's elements, we offer the latest in Eaton's multiplexed line of switch product, the E31 Keypad eSM. Eaton's E31 Keypad eSM multiplex switch module offers a flexible and sealed solution for high-density switch requirements in severe environments. The keypad can be configured with any graphic/switch, as well as with customer-defined illumination. For customers requiring additional switches, expansion modules can be used with no requirement for additional CAN nodes. For additional product flexibility and differentiated operator control, the E31 Keypad eSM is designed to communicate with Eaton's E32 and E33 sealed rocker expansion modules.

Application Description

Great for specialty vehicle, construction, and agricultural equipment markets. The eSM product is especially suitable for severe environmental applications and where there is a desire to move to a multiplexed solution to simplify wiring and control requirements. Typical applications are:

Target Market Segments:

- Tractors
- Wheel loaders
- Refuse vehicles
- Concrete mixers
- Street sweepers
- Mining equipment
- Emergency vehicles
- Transit buses

Contents

Description

E31 eSM—Keypad Multiplexed Switch Module

	<i>Page</i>
Catalog Number Selection	V11-T1-3
Product Selection	V11-T1-4
Technical Data and Specifications	V11-T1-5
Dimensions	V11-T1-5

Features and Benefits

Key Features

- Fully compliant with J1939/CAN 2.0b messaging
- IP68 degree of protection from front and rear of module
- Rocker and keypad expansion module capability
- Exceptional illumination characteristics
 - LED backlighting of icons
 - Four color daylight-visible indicators per switch
 - Message-controlled dimming and flash rates
- Large switch surface area and alignment ridges for ease of gloved hand use
- Exceptional tactile and audible feedback of switch actuation
- Electrical/mechanical life to over 1,000,000 cycles
- 9–32 Vdc operating voltage
- Immunity per SAE J1455/1113
 - Power disturbance
 - Radiated immunity
 - Radiated emissions

Advantages

- Reduced assembly labor due to ease of installation, allowing for mounting and connection of eight switches at one time as opposed to individually
- Reduced wire harness complexity; uses one harness to a controller, reducing wiring, connection point, and controller requirements
- Reduced harness size offers an overall reduction in weight, improving operational efficiency of the equipment
- Increase in life-cycle over traditional electromechanical switches
- Front, rear, and panel sealing for harsh environments

Catalog Number Selection

How To Order—E31 eSM—Keypad Multiplexed Switch Module, 2x4

To determine complete catalog number, start with the appropriate control type and add the appropriate code letters and/or numbers.

Example: **E31 2 4 M 4 W 1 CV 1**

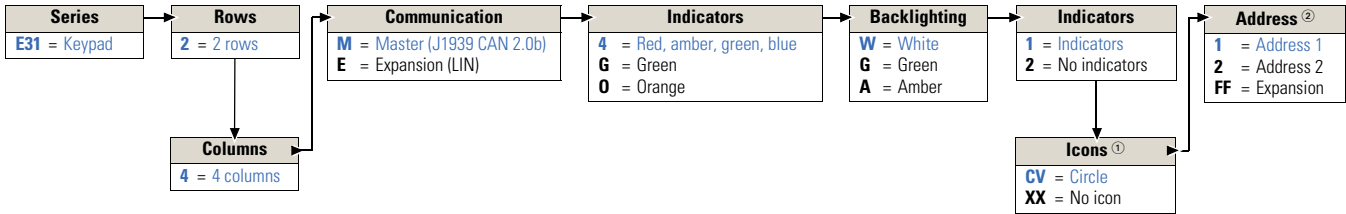

How To Order—E31 eSM—Keypad Master Module, 4x3

To determine complete catalog number, start with the appropriate control type and add the appropriate code letters and/or numbers.

Example: **E31 4 3 M 4 W CV 1**

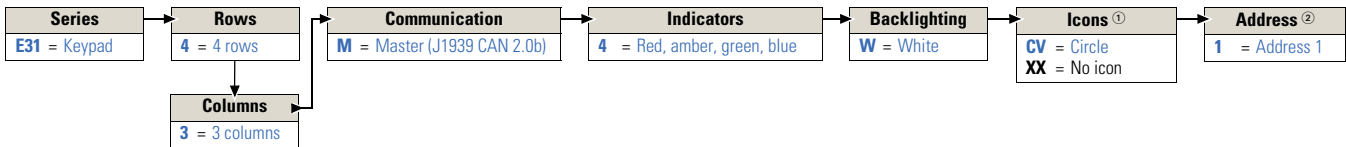

How To Order—E31 eSM—Keypad Master Module, 3x5

To determine complete catalog number, start with the appropriate control type and add the appropriate code letters and/or numbers.

Example: **E31 3 5 M 4 W CV 1**

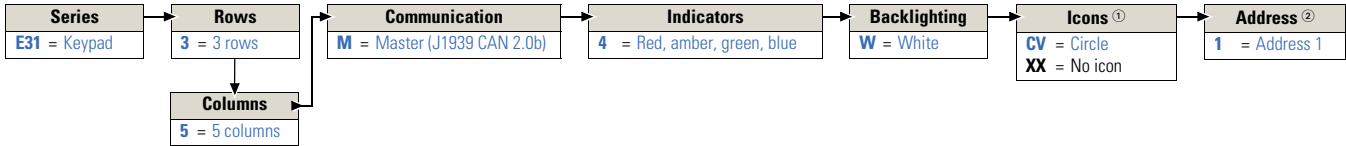

Notes

- ① Contact Eaton sales for custom graphics. See V11-T2-80–V11-T2-84 and V11-T2-95–V11-T2-102, symbols library, for available graphics.
- ② For use of multiple masters on one system. (Address 3–8 available as special order.)

Product Selection

Master

E3124M4W1CV1



E31 Keypad eSM Master Module, 2x4

Basic Part	Indicator Colors	Backlighting	Icon Graphic	Address	Catalog Number
E3124M	Red, amber, green, blue	White	Circle	1	E3124M4W1CV1
				2	E3124M4W1CV2
			None	1	E3124M4W1XX1
				2	E3124M4W1XX2
	Green	Green	Circle	1	E3124MGG1CV1
				2	E3124MGG1CV2
			None	1	E3124MGG1XX1
				2	E3124MGG1XX2
Orange	Amber	Circle	1	E3124MOA1CV1	
			2	E3124MOA1CV2	
		None	1	E3124MOA1XX1	
			2	E3124MOA1XX2	

E3143M—Custom



E31 Keypad eSM Master Module, 4x3

Basic Part	Indicator Colors	Backlighting	Icon Graphic	Address	Catalog Number
E3143M	Red, amber, green, blue	White	Circle	1	E3143M4W1CV1
				2	E3143M4W1CV2
			None	1	E3143M4W1XX1
				2	E3143M4W1XX2

E3135M—Custom



E31 Keypad eSM Master Module, 3x5

Basic Part	Indicator Colors	Backlighting	Icon Graphic	Address	Catalog Number
E3135M	Red, amber, green, blue	White	Circle	1	E3135M4W1CV1
				2	E3135M4W1CV2
			None	1	E3135M4W1XX1
				2	E3135M4W1XX2

Expansion

E3124EGG1XXFF

E31 Keypad eSM Expansion Module, 2x4 ^①

Basic Part	Indicator Colors	Backlighting	Icon Graphic	Address	Catalog Number
E3124E	Red, amber, green, blue	White	Circle	FF	E3124E4W1CVFF
				FF	E3124E4W1XXFF
			None	FF	E3124EGG1CVFF
				FF	E3124EGG1XXFF
	Green	Green	Circle	FF	E3124EGG1CVFF
				FF	E3124EGG1XXFF
			None	FF	E3124E0A1CVFF
				FF	E3124E0A1XXFF

Note

^① Expansion keypad module is available in 2x4 configuration only.

Technical Data and Specifications

Master Module Wiring Harness

The interconnection between the master module and the controller uses a minimum four-wire harness with an additional two pins associated to expansion module interconnection. Wire sizes of 16–20 AWG can be accommodated with the Deutsch connector shown in the mating connector information.

Wiring Harness

PIN	Master	Expansion
1	Vbat	Vbat
2	Common	Common
3	CAN (+)	LIN
4	CAN (-)	LIN
5	Common	Common
6	LIN	Vbat

Environmental and Electronic Specifications

- Operational temperature: -40° to +85°C
- Storage temperature: -40° to +95°C
- Operational voltage: 9–32 Vdc
- Degree of protection: IP68
- Mechanical shock: 30g for 11 msec
- Handling drop: 1m
- Electrical/mechanical life: 1M cycles
- Load dump
 - SAE J1455: 100V/12V systems
 - SAE J1113/11: 174V for 24V systems

Mating Connector Information

Deutsch DT Series connector
 6-pin connector: DT06-6S
 • EP11 (Black–Master)
 • E008 (Gray–Expansion)
 6-pin wedge lock: W6S
 Female terminal: 0462-201-16141 (16-18-20 AWG)
 Hole plug: 0413-217-1605
 Crimper: HDT-48-00



E32 and E33 Rocker Expansion Modules

The Keypad eSM master module is capable of supporting Eaton’s E32 and E33 product line of rocker eSMs. The E32 and E33 product line is an above-panel-style rocker switch module that contains any combination of rocker or indicator functionality with no additional CAN node requirement to the system. Similar to the keypad, the rocker module offers icon graphic illumination with up to four center indicator bar LEDs for status or mode. This product is also fully functional to support dimming and flashing capabilities through software command.

Dimensions

Approximate Dimensions in mm [in]

2x4 Mounting Dimensions

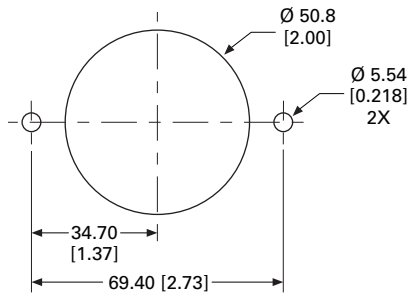

E31 Keypad Master or Expansion Module

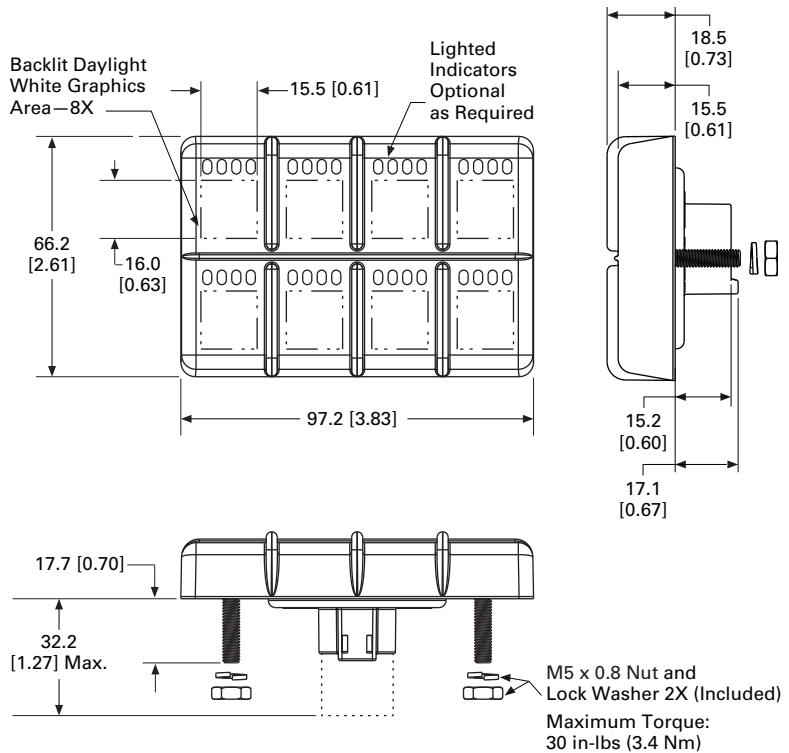

1.1

Electronic Products

E31 eSM—Keypad Multiplexed Switch Module

1

Approximate Dimensions in mm [in]

4x3 Mounting Dimensions

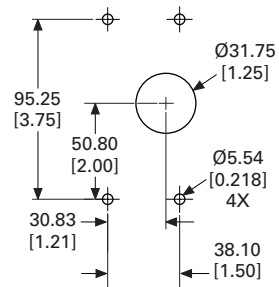

Recommended Panel Opening

E31 Keypad Master Module

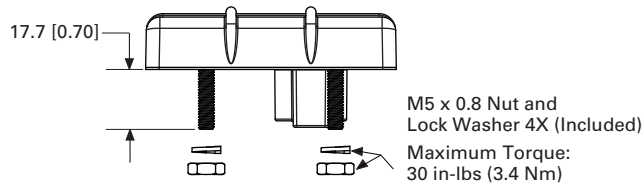
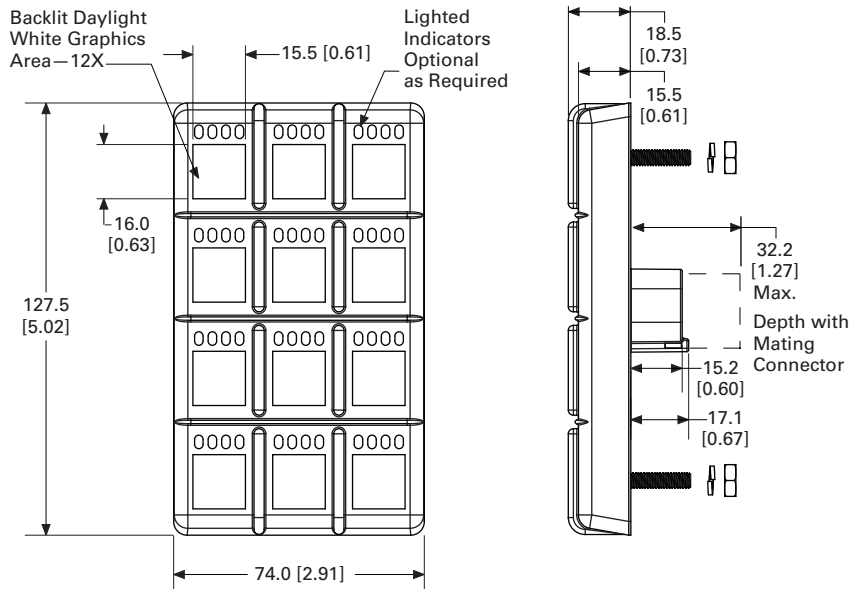

3x5 Mounting Dimensions

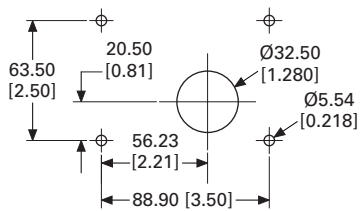

Recommended Panel Opening

E31 Keypad Master Module

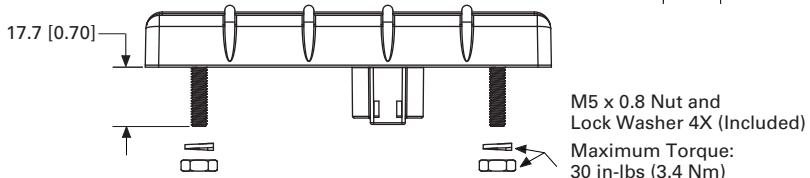
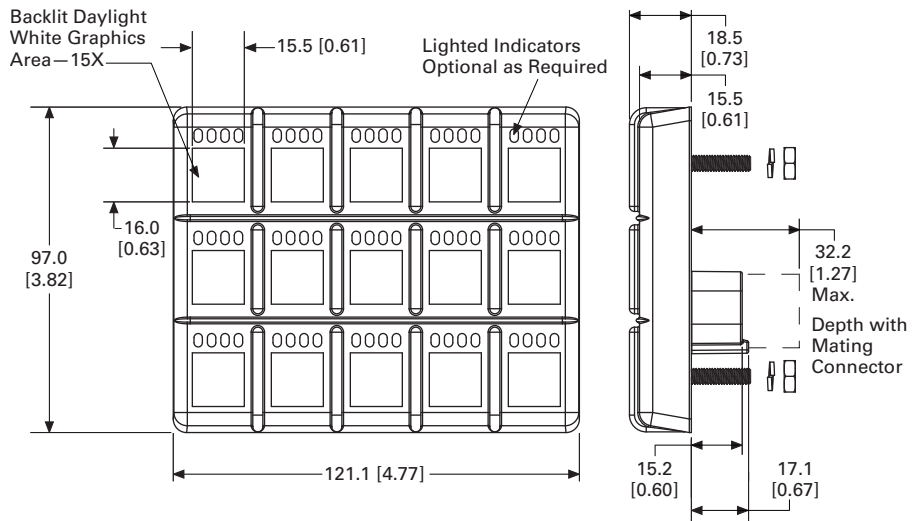

E30 eSM—Multiplexed Rocker Switch Units



Contents

Description

E30 eSM—Multiplexed Rocker Switch Units	
Technical Data and Specifications	V11-T1-8
Wiring	V11-T1-9
Dimensions	V11-T1-10

Product Description

Tailored to meet the same look and feel of Eaton’s NGR product line, the E30 eSM offers the added benefits of multiplexed control and system simplification. The E30 eSM is a below-panel styled multiplexed rocker module capable of communicating via SAE J1939 CAN 2.0b. The modules are set up in a master-expansion configuration capable of supporting up to seven

expansion modules per master thus minimizing the impact on a controller to a single CAN node. Additionally, up to eight master modules per system can be accommodated. Communication with the expansion modules is done via a four-wire sub-bus.

Multiplexing of switches can significantly reduce harness costs and complexity as well as improve installation cycle time.

Application Description

The E30 eSM is especially suited for applications that require both high current independently wired switches using Eaton NGR switches as well as those applications realizing the benefits of multiplexing. The E30 eSM is styled to match the Eaton NGR switch for a consistent look and feel to your dash panel.

Customization of the E30 eSM is done by creating an application specific rocker with icons representing the function as well as by use of colored LEDs to highlight status. Two and three position as well as momentary or maintained circuits are identified using a sub-actuator to offer complete flexibility.

Target Market Segments:

- Motor coach/bus
- Specialty vehicle
- Truck

The E30 eSM also has the capability of having a separate input for key switch and dimmer control functions to increase the flexibility of the product to interface seamlessly to your vehicle.

Master Expansion Modules

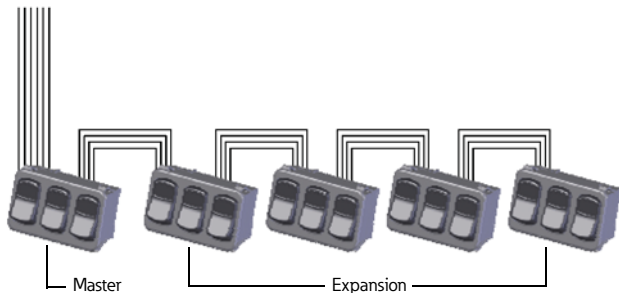

Product Selection

Note: All products are custom ordered. Contact your local Eaton Sales Representative.

Technical Data and Specifications

E30 eSM Specifications

Description	Specification
Power supply	12 Vdc regulated power, 1.5A
Operating temperature	-40° to 85°C
Storage temperature	-40° to 85°C
Sealing	IP42
Illumination	Dependent on search lighting, customer defined LED color
Switch life cycle	
Electrical life	250,000 cycles
Mechanical life	250,000 cycles
Radiated immunity	SAE J1113/21, 100 v/m
Radiated emissions	SAE J1113/41, Class 2
Dimming	0-10 Vdc Analog Input (0 = 0% and 10V = 100% brightness)
Connectors	Delphi Micro VHT 15499927 Delphi Micro VHT 13513469

Power Supply

A regulated 12 Vdc power supply capable of providing 1.5A should be connected to terminals 1, 5 and 6 of the six-pole connector of the master module only. All connected expansion modules receive their supply power from the master module.

Diagnostics

The LED indicators at the back of the modules show the status of the internal diagnostics as follows:

Diagnostics

Label	Color	Meaning
J1939 ACTIVE	Red	CANbus active
MODULE ACTIVE	Amber	Sub bus active
SWITCH CHANGE	Green	Switch change

Communication

The communication to and from the master module is fully compliant to the SAE J1939/CAN 2.0b protocol.

The application-specific J1939 message parameters are as follows:

Transmission Repetition

Description	Specification
Transmission repetition rate	100 ms
Data length	8 bytes
Data page	0
PDU format	255
PDU specific	160
Default priority	5
Parameter group number	65440

SAE J1455

Description	Specification
Dust test (Non-operational)	SAE J726 Course
Mechanical vibration	2gs from 10 to 2 kHz
Mechanical shock	30g
Handling drop	1m, 3-axis
Load dump transient	Table 4A and 4B
Reverse voltage	-28 Vdc for 5 mins
Over-voltage	48 Vdc for 5 mins
Under-voltage	4 Vdc for 5 mins

Message Contents

Status

Byte	Status
Byte 1	Master module status
Byte 2	Expansion module 1 status
Byte 3	Expansion module 2 status
Byte 4	Expansion module 3 status
Byte 5	Expansion module 4 status
Byte 6	Expansion module 5 status
Byte 7	Expansion module 6 status
Byte 8	Expansion module 7 status

Within each status byte, the bits are assigned to the individual switches as follows:

Bit	Switch
Bit 8&7	Not defined
Bit 5&6	Switch 1 status
Bit 3&4	Switch 2 status
Bit 1&2	Switch 3 status

where the switches are numbered as shown below.

Switches

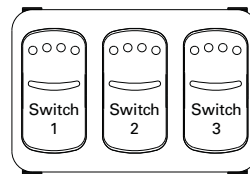

The two status bit pairs represent the switch state in the following manner:

Bit	Switch
00	Switch in DOWN position
01	Switch in MIDDLE position
10	Switch in UP position
11	Not defined

where the position assignment is as shown below.

Position Assignment

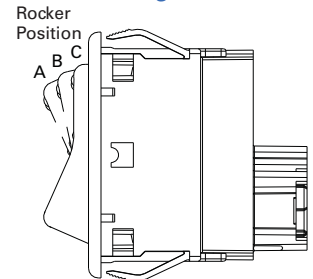

A = DOWN
B = MIDDLE
C = UP

Wiring

The master unit is connected using six unshielded wires. The connection from the master to the first expansion module and between any consecutive expansion modules is made using four unshielded wires.

Master Module

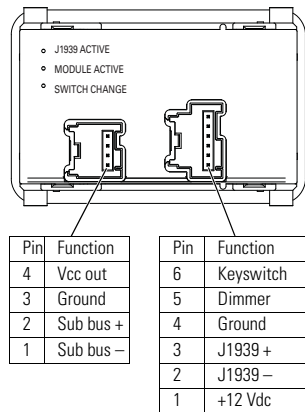

Expansion Module

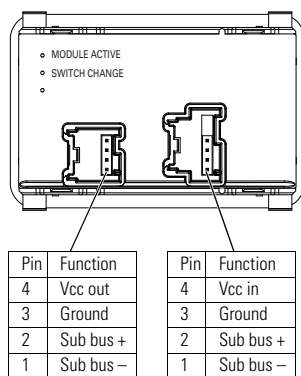

Master wiring:

- Six unshielded wires

Expansion wiring:

- Four unshielded wires

Dimensions

Approximate Dimensions in Inches (mm)

Mounting Dimensions

If you want to mount the modules in a panel, the opening in the panel should be rectangular, 2.835 in wide and 1.732 in high (72.00 mm wide and 44.00 mm high).

The panel thickness should be between 0.039 and 0.157 in (1.00 and 4.00 mm).

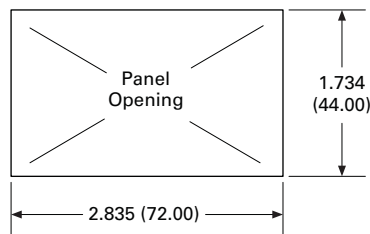

E30 eSM Multiplexed Rocker Switch Units

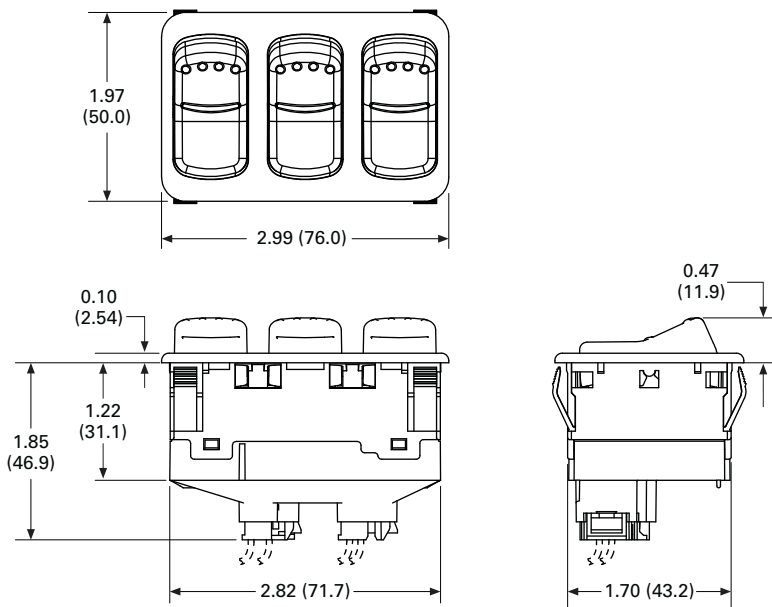



Contents

Description

	<i>Page</i>
E32 eSM—Multiplexed Rocker Switch Units	
Product Selection	V11-T1-13
Accessories	V11-T1-13
Wiring	V11-T1-15
Dimensions	V11-T1-17

Product Description

Multiplexed Master Module using a LIN sub bus to communicate with up to seven expansion modules.

Offering a high level of flexibility, the above-panel electronic multiplex switch module (E32 eSM) covers your wide range of switch and indicator applications using standard or custom graphics, as well as a full range of circuits and illumination options. The above-panel E32 eSM has top, center and bottom LED lighting with software that offers advanced circuit and lighting flexibility, including dimming and flashing options via J1939 CANbus communication. The indicator bar can be lighted with up to four separate colors to indicate operational status, vehicle mode and faults. All standard combinations of maintained and momentary switch actions, matching indicator caps and dummy plugs, along with the complementary styled SVR electromechanical rocker switch are available to complete the offering.

Compared with electromechanical switches, multiplexed switch modules offer several advantages.

- Reduced assembly labor due to ease of installation, allowing for mounting and connection of three switches at one time versus individually
- Reduced wire harness complexity, using one harness to a controller to accommodate up to 24 switches and a three-wire interconnect between expansion and master modules
- Reduced harness size offers an overall reduction in weight, improving operational efficiency of the equipment
- Increase in switch life-cycle over traditional electromechanical switches (500k cycles)

Application Description

Target Market Segments

This product is targeted at the bus/coach, truck and specialty vehicle markets. The product is especially suitable where a customer has “gangs” of switches mounted in a panel or dashboard, and expansion modules can be connected easily to a master module.

- On-road specialty vehicle
- EMS vehicles
- Street sweepers
- Recreational vehicles
- Motor coach/bus
- Refuse vehicles

Features and Benefits

- Fully compliant with J1939 CAN 2.0b messaging
- LED lighting in top, center and bottom positions
- Late point definition of circuit and rockers to reduce inventory and accommodate multiple application requirements
- 9–16 Vdc operating voltage
- 16–32 Vdc operating voltage
- IP53 degree of protection from the front
- Easy address assignment
- Immune to SAE J1455 and J1113 power disturbances
- Front panel removable for ease of maintenance
- Sleep mode available to reduce current draw on the battery
- Wake on switch change configurable
- Decorative-style rocker with matching indicator option available
- Colored rocker options
- CAN controlled digital logic output—500 mA

Product Selection

Note: All fully-assembled products are custom ordered. Contact your local Eaton Sales Representative.



Modules

Voltage	Module	Icon Lighting	Status Bar Lighting	Catalog Number
9–16V	Master	Amber	Amber	E321AAAAAAAAA01
		Green	Green	E321GGGGGGGGG01
		White	Red, Amber, Green, Blue	E321W4WW4WW4W01
	Expansion	Amber	Amber	E322AAAAAAAAA01
		Green	Green	E322GGGGGGGGG01
		White	Red, Amber, Green, Blue	E322W4WW4WW4W01
	Indicator expansion	Amber	Amber	E322AAAAAAAAA17
		Green	Green	E322GGGGGGGGG17
		White	Red, Amber, Green, Blue	E322W4WW4WW4W17
16–32V	Master	Amber	Amber	E323AAAAAAAAA01
		Green	Green	E323GGGGGGGGG01
		White	Red, Amber, Green, Blue	E323W4WW4WW4W01
	Expansion	Amber	Amber	E324AAAAAAAAA01
		Green	Green	E324GGGGGGGGG01
		White	Red, Amber, Green, Blue	E324W4WW4WW4W01
	Indicator expansion	Amber	Amber	E324AAAAAAAAA17
		Green	Green	E324GGGGGGGGG17
		White	Red, Amber, Green, Blue	E324W4WW4WW4W17

Accessories

Rockers

Color	Description	Catalog Number
Black	Full-throw actuator	53-7350
	Half-throw up actuator	53-7350-2
	Half-throw down actuator	53-7350-3
Red	Full-throw actuator	53-7350-4
	Half-throw up actuator	53-7350-5
	Half-throw down actuator	53-7350-6
Black	Indicator	53-7354
	Dummy plug	53-7354-2
	Panel plug	17-24241

Circuit Sub-Actuators

Color	Circuit (Up-Middle-Down)			Catalog Number
Black	On	On	None	61-4043
Red	Momentary	On	None	61-4043-2
Light blue	On	On	On	61-4043-3
White	Momentary	On	Momentary	61-4043-4
Yellow	Momentary	On	On	61-4043-5
Gray	On	None	On	61-4043-6
Pink	Momentary	None	On	61-4043-7
Maroon	None	On	On	61-4043-8
Light purple	None	On	Momentary	61-4043-9
Orange	On	On	Momentary	61-4043-10
Green	On	None	Momentary	61-4043-11

1

Wiring

Master Module Wire Harness

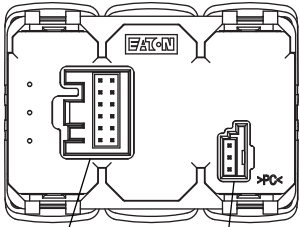

Pin	Function
1	VBAT (clamp 30)
2	Ground
3	CAN high
4	CAN low
5	500 mA output
6	Address 1
7	Address 2
8	Address 3
9	Address 4
10	No connect
11	No connect
12	No connect

Pin	Function
1	VBAT (clamp 30)
2	Ground
3	LIN sub bus

The interconnection between master module and controller uses a simple four-wire harness with addressing specified by jumping between pins 6 to 9. An additional pin-out is provided for a 500 mA output if required.

Mating Connector Information

Housing:

- ETN 28-6982
- Amp/Tyco #1394048-1
- ETN 49-7867
- Amp/Tyco #2-1355524-3

Expansion Module Wire Harness

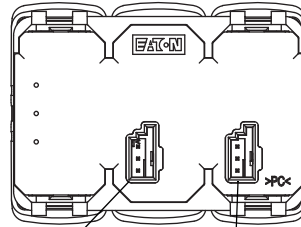

Pin	Function
1	VBAT (clamp 30)
2	Ground
3	LIN sub bus

Pin	Function
1	VBAT (clamp 30)
2	Ground
3	LIN sub bus

The interconnection between modules uses a cost-effective three-wire harness. This simplified wire harness reduces cost, weight and assembly labor for the end-user.

Mating Connector Information

Terminal:

- ETN 28-6983
- Amp/Tyco #1-1718346-1 Coding A
- ETN 80-20608
- Amp/Tyco #963715-1

Master Address Assignment

The master switch module address is set using jumpers in the wire harness to connect the following pins:

Master Address Assignment

Terminal Pins Connected	Address
6-7	A1
6-8	A2
6-9	A3
7-8	A4
7-9	A5
8-9	A6
6-7, 8-9	A7
6-8, 7-9	A8

Manufacturing Flexibility

E32 eSM offers a tremendous amount of flexibility including options for complete assemblies to be provided as well as late-point definable rocker and circuit. Individual components can be purchased independently and assembled to create any combination of circuits and icons which is especially suited for low volume/high mix applications minimizing inventory requirements. Rockers and indicators can also be laser-etched with custom icons by Eaton or other to accommodate application specific requirements. Contact your Eaton representative to discuss the Eaton solution further.

Dimensions

Approximate Dimensions in mm

Mounting Instructions

The modules are easily mounted with plastic retention clips. Modules are mounted in a single, space-saving cutout, reducing assembly time and accommodating up to three switches in a compact design.

The unit will accommodate 1.5 to 3 mm panel thickness.

Mounting Dimensions

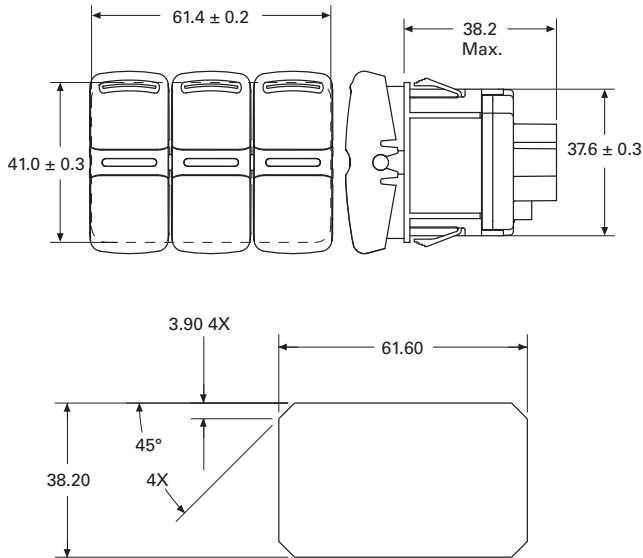



Product Description

Sealed Multiplexed Master Module using a LIN sub bus to communicate with up to seven expansion modules.

Eaton is pleased to introduce the newest line of multiplexed electronic Switch Modules (eSM), the E33 product line. The E33 eSM offers an increased level of flexibility over previous modules including:

- Fully sealed to IP68 from the front and rear
- Locking rocker options
- Palm guard option

The E33 eSM offers a complete range of switch circuits as well as indicator options to meet all your control requirements. Similar to the E32 eSM product line, the E33 eSM includes individual icon lighting as well as a multi-color center indicator option allowing for steady state, flashing and dimming controlled via messaging. Additional flexibility is available by using the Eaton IP68 sealed SVR switch line for high-current, hard-wired applications in conjunction with our multiplexed solution.

Compared with electromechanical switches, multiplexed switch modules offer several advantages.

- Reduced assembly labor due to ease of installation, allowing for mounting and connection of three switches at one time versus individually
- Reduced wire harness complexity, using one harness to accommodate up to 24 switches and a three-wire interconnect between expansion and master modules
- Reduced harness size offers an overall reduction in weight, improving operational efficiency of the equipment
- Increase in switch life-cycle over traditional electromechanical switches (500k cycles)
- Reduced connections resulting in less possible failure points

Contents

Description

	<i>Page</i>
E33 eSM—Keypad Multiplexed Switch Module	
Product Selection	V11-T1-22
Wiring	V11-T1-22
Technical Data and Specifications	V11-T1-22
Dimensions	V11-T1-23

Application Description

Target Market Segments

This product is targeted at harsh environment applications where a ruggedized product is needed to meet demanding requirements. Additionally, applications where there is concern over inadvertent switch actuation driving the need for guarding or locking features are also well-suited. Typical applications include:

- Construction equipment
- Agricultural equipment
- Specialty vehicle
- Material handling
- Emergency vehicle
- School and transit bus

Features and Benefits

- Fully compliant with J1939 CAN 2.0b messaging
- IP68 degree of protection front and rear
- 9–32 Vdc rated
- Immune to SAE J1455 and J1113 power disturbances
- Top, bottom and full guard option available
- Locking rocker available
- Front panel removable for ease of maintenance
- Sleep mode available to reduce current draw on the battery
- Wake on switch change configurable
- LED lighting in top, center-indicator and bottom position
- Decorative style rocker with matching indicator option
- Late point definition of circuit and rockers to reduce inventory
- Diagnostics

Contact your Eaton sales engineer for availability.

Product Selection

Note: All fully-assembled products are custom ordered. Contact your local Eaton Sales Representative.

Wiring

Master/Expansion Module Wire Harness

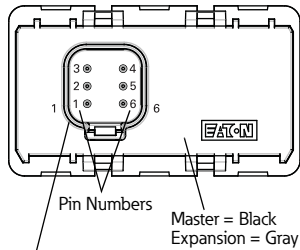

Pin	Master	Expansion
1	VBATT	VBATT
2	Common	Common
3	CAN High	LIN
4	CAN Low	LIN
5	Common	Common
6	LIN	VBATT

The interconnection between master module and controller uses a simple four-wire harness. Addressing of the master can be done by software or via address claim process. Interconnect wiring between master-expansion as well as expansion-expansion uses a three-wire harness.

Mating Connector Information

- Mating connector: Deutsch plug DT06-6S
- Wedge lock: W6S
- Socket contact: 0462-201-16141 (1.0–0.5 mm² [16–20 AWG])
- Hole plug: 0413-217-1605

Technical Data and Specifications

E33 eSM Specifications

Description	Specification
Operating temperature	–40° to 85°C
Storage temperature	–40° to 95°C
Operating voltage	9–32 Vdc
Environmental sealing	IP68
Mechanical shock	30g for 11 ms
Mechanical vibration	MIL-STD-202F/201A 2.0g random
Immunity to SAE J1455 and J1113 power disturbances	
Communication	
Master	SAE J1939 CAN 2.0b
Expansion	LIN 2.0

Contact your Eaton sales engineer for availability.

1

Dimensions

Approximate Dimensions in Inches (mm)

Standard Cut-Out

The modules are easily mounted with plastic retention clips. Modules are mounted in a single, space-saving cutout reducing assembly time and accommodating up to three switches in a compact design.

Serviceability

By modifying the standard cut-out to include the optional front panel removable slots shown below, the modules are easily serviceable from the front of the panel without further disassembly.

Due to the E33's design allowing for late-point definition on assembly, both the actuator and circuit profile are serviceable as individual components.

Standard Cut-Out

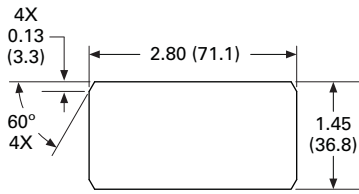

Recommended Panel Opening
Panel Thickness: 0.04–0.16 (1.0–4.0)

Optional Panel Opening Features

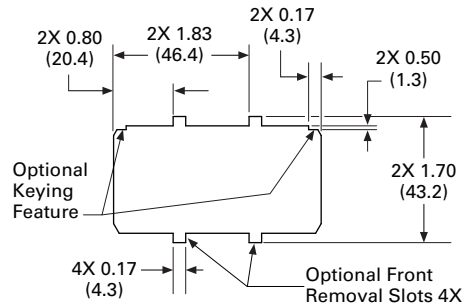

E33 eSM Sealed Multiplexed Rocker Switch Units

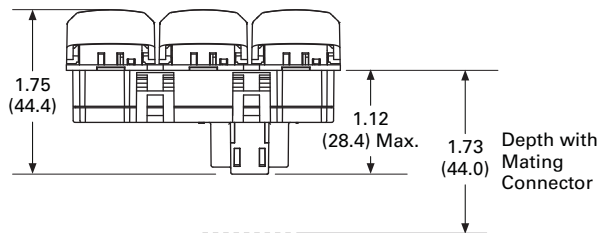
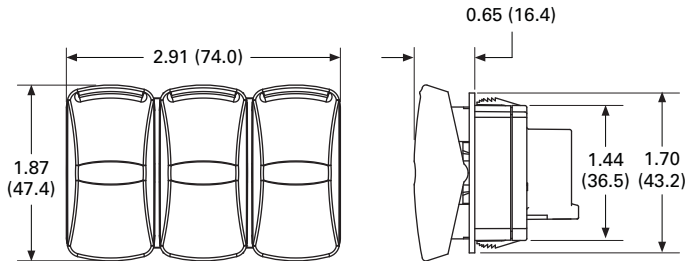

E33 eSM Sealed Multiplexed Rocker Switch Units (Palm Guard Version)

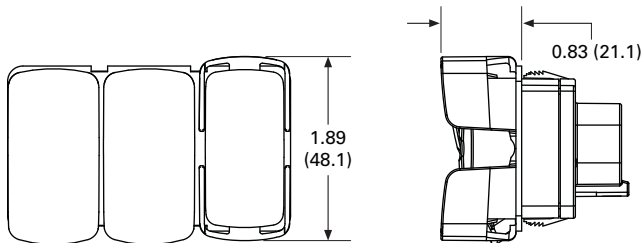

Contact your Eaton sales engineer for availability.

eVu—Electronic Vehicle Display



Product Description

With a focus on communications, convenience and safety, Eaton is pleased to introduce eVu.

Rugged dashpanel displays simplify the viewing, selecting and inputting of key equipment/trip data.

Working in sync with existing controllers and networks, the displays provide the driver with valuable feedback on vehicle status and performance.

eVu displays offer a great deal of flexibility which can include:

- Internal warning/alert buzzer
- Backlighting legend displays
- Sunlight readable LCD characters
- Internal power supply
- Analog or discrete switch inputs
- Up to 2.5 digit character display
- 8-segment bar graph
- Individual LED control

So, what's the e for?

Easy, **e**lectronic and **e**volutionary. eVu fills the gap (literally) between on-board systems and displays, ideal for application-specific functions.

Application Description

Typical applications for information display include:

- Temperature
- Pressure
- Speed
- Distance
- Capacity
- Transmission
- Warnings/alarms
- System information

Safety

eVu displays are easier to access than typical touch screens or soft-key applications. Keeping the dashboard displays within the driver's line of vision helps keep the driver and everyone else on the road safe. Additionally, the eVu displays are designed to meet SAE-1455 specification.

What Do You Want to View?

There are many types of eVu displays and they can be customized with various colors, resolutions and character configurations. Choose the functionality you want with the flexibility you need.

Contents

Description

eVu—Electronic Vehicle Display

Features

Communication and Networking

eVu displays can interface with smart engines, controllers and equipment software via established J1939 and J1708 communication protocols.

In addition, eVu displays can receive input from analog transducers and sub-systems. Analog inputs can be either 0–20 mA or 0–10V. Additional input options exist for up to six logic states.

Designed for Easy Installation

Some advancements in technology create installation obstacles. That isn't the case with eVu. The displays fit into the same cutouts as standard Eaton NGR rocker switches, 0.866 x 1.732 in (22.00 x 44.00 mm), making installation easy. The simplified architecture not only saves dash space, it also saves costs.

Product Selection

Note: All products are custom ordered. Contact your local Eaton Sales Representative.

Dimensions

Approximate Dimensions in mm [in]

Mounting Instructions

Product is designed to mount in panels between 1 to 4 mm (0.039 to 0.157 in) thick.

eVu—Electronic Vehicle Display

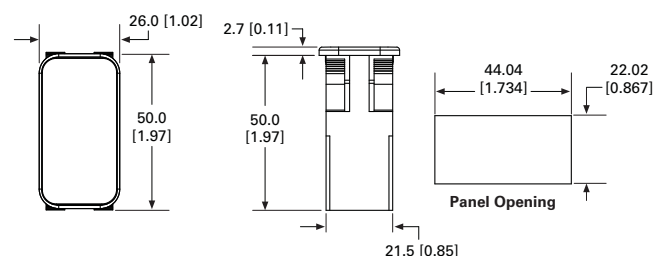

NGR



SVR



Rockette



EURO SR



ESPORT



2.1 Introduction	
Product Selection Guide	V11-T2-3
2.2 NGR	
Product Description	V11-T2-8
Catalog Number Selection	V11-T2-10
2.3 SVR	
Product Description	V11-T2-32
Catalog Number Selection	V11-T2-34
2.4 Dual Motion Safety Switch	
Product Description	V11-T2-43
Catalog Number Selection	V11-T2-44
2.5 1500/2500	
Product Description	V11-T2-45
Catalog Number Selection	V11-T2-46
2.6 1600/2600	
Product Description	V11-T2-49
Catalog Number Selection	V11-T2-50
2.7 Rockette	
Product Description	V11-T2-56
Catalog Number Selection	V11-T2-57
2.8 8006/8007—EURO SR	
Product Description	V11-T2-64
Catalog Number Selection	V11-T2-65
2.9 8004/8005—Euro Full Size	
Product Description	V11-T2-67
Catalog Number Selection	V11-T2-68
2.10 X Series	
Product Description	V11-T2-70
Catalog Number Selection	V11-T2-71
X Series Symbols Library	V11-T2-72
2.11 8064/8065 ESPORT	
Product Description	V11-T2-74
Catalog Number Selection	V11-T2-75
Icon/Legend Selection	V11-T2-76
2.12 Accessories	
Dimensions	V11-T2-78
2.13 Technical Data	
Rocker, Toggle and Pushbuttons	V11-T2-80
Rocker Switch Circuit Diagrams	V11-T2-81
2.14 Symbol Library	
NGR, SVR, E31, E32 and E33 eSM Symbols	V11-T2-82
NGR Only Symbols	V11-T2-87
SVR, E31, E32 and E33 eSM Symbols	V11-T2-97

Rocker Switch Products

2



Contents

Description

Rocker Selection Guide	V11-T2-3
NGR Rocker Switches	V11-T2-8
SVR—Sealed Vehicle Rockers	V11-T2-32
Dual Motion Safety Switches	V11-T2-43
1500/2500—Midsize AC Rated	V11-T2-45
1600/2600—Midsize AC Only	V11-T2-49
Rockette—General Purpose AC Rated	V11-T2-56
8006/8007—EURO SR	V11-T2-64
8004/8005—Euro Full Size	V11-T2-67
X Series Rockers	V11-T2-70
8064/8065—ESPORT	V11-T2-74
Accessories	V11-T2-78
Technical Data	V11-T2-80
Symbols Library	V11-T2-82

Rocker Selection Guide

See Technical Data and Dimensions for more details.

Rocker Switches—Illuminated and Non-Illuminated

NGR

SVR



Features

Ratings	15A at 125 Vac, 10A at 250 Vac; 15A at 28 Vdc (14 Vdc rating)	12A at either 12 or 24 Vdc
Certifications	RoHS, UL® Approvable	RoHS, UL Approvable
Panel Opening	Rectangular	Octagonal
Single- and two-pole length	1.734 in (44.04 ± 0.13 mm)	0.830 in (21.10 mm); 0.680 in (17.30 mm)
Single-pole width	0.867 in (22.02 ± 0.13 mm)	1.450 in (36.80 mm); 1.190 in (30.20 mm)
Two-pole width	0.867 in (22.02 ± 0.13 mm)	1.450 in (36.80 mm); 1.190 in (30.20 mm)
Seal		
Top (internal)	✓	✓
Bottom (internal)	—	✓
Panel	✓	✓
Actuator		
Rocker without bezel	—	✓
Rocker with bezel	✓	✓
Paddle	✓	✓
Snap-in lens	✓	✓
Locking	✓	—
Label	✓	—
Decorative		
Laser-etch	✓	✓
Pad-print	✓	✓
Poles		
Single	✓	✓
Double	✓	✓
Four	—	—
Termination		
Spade	✓	✓
Solder	—	—
Screw	—	—
Weld lugs	—	—
Illumination		
Incandescent 6 Vdc	—	—
Incandescent 12 Vdc	—	—
Incandescent 14 Vdc	✓	—
Incandescent 18 Vdc	✓	—
Incandescent 24 Vdc	—	—
Incandescent 28 Vdc	✓	—
Neon 110V	—	—
Neon 125V	—	—
Neon 250V	—	—
14V LED	✓	✓
28V LED	✓	✓
Catalog Number Selection	Page V11-T2-10	Page V11-T2-34
Technical Data	Page V11-T2-16	Page V11-T2-36
Circuit Diagrams	Page V11-T2-17	Page V11-T2-37
Dimensions	Page V11-T2-30	Page V11-T2-38
Icon/Legend Symbols Library	Page V11-T2-82	Page V11-T2-82

See Technical Data and Dimensions for more details.

Rocker Switches—Illuminated and Non-Illuminated, continued

2

Dual Motion Safety Switch

1500/2500



Features

Ratings	10A at 250 Vac, 15A at 125 Vac, 3/4 hp at 250 Vac	Up to 22A at 125 Vac, 16A at 250 Vac
Certifications	UL, CSA®, RoHS	UL, CSA, ENEC, RoHS
Panel Opening	Octagonal	Rectangular
Single- and two-pole length	1.450 in (36.80 mm); 1.190 in (30.20 mm)	1.075 in (27.30 ± 0.10 mm)
Single-pole width	0.830 in (21.10 mm); 0.680 in (17.20 mm)	0.483 in (12.27 ± 0.07 mm)
Two-pole width	N/A	0.876 in (22.25 ± 0.10 mm)
Seal		
Top (internal)	—	—
Bottom (internal)	—	—
Panel	—	—
Actuator		
Rocker without bezel	—	—
Rocker with bezel	✓	✓
Paddle	✓	✓
Snap-in lens	—	—
Locking	—	—
Label	—	—
Decorative		
Laser-etch	—	—
Pad-print	✓	✓
Poles		
Single	✓	✓
Double	—	✓
Four	—	—
Termination		
Spade	✓	✓
Solder	✓	✓
Screw	✓	—
Weld lugs	—	—
Illumination		
Incandescent 6 Vdc	—	✓
Incandescent 12 Vdc	—	✓
Incandescent 14 Vdc	—	—
Incandescent 18 Vdc	—	—
Incandescent 24 Vdc	—	✓
Incandescent 28 Vdc	—	—
Neon 110V	—	—
Neon 125V	—	✓
Neon 250V	—	✓
14V LED	—	—
28V LED	—	—
Catalog Number Selection	Page V11-T2-44	Page V11-T2-46
Technical Data	—	Page V11-T2-48
Circuit Diagrams	—	Page V11-T2-80
Dimensions	Page V11-T2-44	Page V11-T2-48
Icon/Legend Symbols Library	—	Page V11-T2-55

See Technical Data and Dimensions for more details.

Rocker Switches—Illuminated and Non-Illuminated, continued

1600/2600

Rockette



Features

Ratings	Up to 22A at 125 Vac, 16A at 250 Vac	Up to 15A at 125 Vac, 10A at 250 Vac, 3/4 hp at 250 Vac
Certifications	UL, CSA, ENEC, RoHS	UL, CSA, RoHS
Panel Opening	Rectangular	Octagonal
Single- and two-pole length	1.075 in (27.30 ± 0.10 mm)	1.450 in (36.83 mm); 1.190 in (30.23 mm)
Single-pole width	0.483 in (12.27 ± 0.07 mm)	0.830 in (21.80 mm); 0.680 in (17.27 mm)
Two-pole width	0.876 in (22.25 ± 0.10 mm)	0.830 in (21.80 mm); 0.680 in (17.27 mm)
Seal		
Top (internal)	—	✓
Bottom (internal)	—	—
Panel	—	—
Actuator		
Rocker without bezel	—	—
Rocker with bezel	✓	✓
Paddle	✓	—
Snap-in lens	—	—
Locking	—	—
Label	—	—
Decorative		
Laser-etch	—	—
Pad-print	✓	✓
Poles		
Single	✓	—
Double	✓	✓
Four	—	✓
Termination		
Spade	✓	✓
Solder	✓	✓
Screw	—	✓
Weld lugs	—	—
Illumination		
Incandescent 6 Vdc	✓	—
Incandescent 12 Vdc	✓	—
Incandescent 14 Vdc	—	✓
Incandescent 18 Vdc	—	—
Incandescent 24 Vdc	✓	—
Incandescent 28 Vdc	—	✓
Neon 110V	—	✓
Neon 125V	—	—
Neon 250V	—	—
14V LED	—	—
28V LED	—	—
Catalog Number Selection	Page V11-T2-50	Page V11-T2-57
Technical Data	Page V11-T2-54	Page V11-T2-60
Circuit Diagrams	Page V11-T2-80	Page V11-T2-80
Dimensions	Page V11-T2-54	Page V11-T2-60
Icon/Legend Symbols Library	Page V11-T2-55	—

See Technical Data and Dimensions for more details.

Rocker Switches—Illuminated and Non-Illuminated, continued

2

8006/8007

8004/8005



Features

Ratings	10A at 250 Vac, 15A at 125 Vac, 3/4 hp at 250 Vac, recommended up to 15A at 28 Vdc	10A at 250 Vac, 15A at 125 Vac, 3/4 hp at 250 Vac, recommended up to 15A at 28 Vdc
Certifications	UL(CUR), RoHS	UL(CUR), RoHS
Panel Opening	Octagonal	Rectangular
Single- and two-pole length	1.450 in (36.85 mm); 1.190 in (30.23 mm)	1.734 in (44.04 ± 0.13 mm)
Single-pole width	0.830 in (21.08 mm); 0.680 in (17.27 mm)	0.867 in (22.02 ± 0.13 mm)
Two-pole width	0.830 in (21.08 mm); 0.680 in (17.27 mm)	0.867 in (22.02 ± 0.13 mm)
Seal		
Top (internal)	✓	✓
Bottom (internal)	—	—
Panel	—	—
Actuator		
Rocker without bezel	—	—
Rocker with bezel	✓	✓
Paddle	✓	—
Snap-in lens	✓	✓
Locking	—	—
Label	—	✓
Decorative		
Laser-etch	—	—
Pad-print	✓	✓
Poles		
Single	✓	✓
Double	✓	✓
Four	—	—
Termination		
Spade	✓	✓
Solder	✓	✓
Screw	✓	✓
Weld lugs	—	—
Illumination		
Incandescent 6 Vdc	—	—
Incandescent 12 Vdc	—	—
Incandescent 14 Vdc	✓	✓
Incandescent 18 Vdc	✓	✓
Incandescent 24 Vdc	—	—
Incandescent 28 Vdc	✓	✓
Neon 110V	—	—
Neon 125V	✓	✓
Neon 250V	✓	✓
14V LED	—	—
28V LED	—	—
Catalog Number Selection	Page V11-T2-65	Page V11-T2-68
Technical Data	Page V11-T2-66	Page V11-T2-69
Circuit Diagrams	Page V11-T2-80	Page V11-T2-80
Dimensions	Page V11-T2-66	Page V11-T2-69
Icon/Legend Symbols Library	—	—

See Technical Data and Dimensions for more details.

Rocker Switches—Illuminated and Non-Illuminated, continued

X Series

8064/8065



Features

Ratings	16A 125V, 10A 277V, 3/4 hp 277V Recommended 21A 14 Vdc or 10A 28 Vdc	10A at 250 Vac, 15A at 125 Vac, 3/4 hp at 250 Vac, recommended up to 15A at 28 Vdc
Certifications	UL(CUR); RoHS, T85	UL(CUR); RoHS
Panel Opening	Rectangular	Rectangular
Single- and two-pole length	1.46 in (37.00 ± 0.1 mm)	1.734 in (44.04 ± 0.13 mm)
Single-pole width	0.83 in (21.20 ± 0.1 mm)	0.867 in (22.02 ± 0.13 mm)
Two-pole width	0.83 in (21.20 ± 0.1 mm)	0.867 in (22.02 ± 0.13 mm)
Seal		
Top (internal)	✓	—
Bottom (internal)	—	—
Panel	—	—
Actuator		
Rocker without bezel	—	—
Rocker with bezel	✓	✓
Paddle	—	✓
Snap-in lens	—	—
Locking	—	—
Label	—	✓
Decorative		
Laser-etch	✓	—
Pad-print	—	✓
Poles		
Single	✓	✓
Double	✓	✓
Four	—	—
Termination		
Spade	✓	✓
Solder	✓	—
Screw	✓	—
Weld lugs	—	—
Illumination		
Incandescent 6 Vdc	—	—
Incandescent 12 Vdc	—	—
Incandescent 14 Vdc	—	—
Incandescent 18 Vdc	—	—
Incandescent 24 Vdc	—	—
Incandescent 28 Vdc	—	—
Neon 110V	—	—
Neon 125V	—	—
Neon 250V	—	—
14V LED	✓	✓
28V LED	✓	✓
125V LED	✓	—
277V LED	✓	—
Catalog Number Selection	Page V11-T2-71	Page V11-T2-75
Technical Data	Page V11-T2-72	Page V11-T2-76
Circuit Diagrams	Page V11-T2-72 (Light Diagrams)	Page V11-T2-80
Dimensions	Page V11-T2-73	Page V11-T2-77
Icon/Legend Symbols Library	Page V11-T2-72	Page V11-T2-76

NGR Rocker Switches

2



Product Description

Eaton presents its NGR Rocker Switches. This field-proven line of full-sized rocker switches, initially developed for the heavy truck industry, is now found in a variety of vehicle-related applications.

The NGR offers both European styling and ergonomic design while still providing the solid durability that you have come to expect from Eaton switches.

Illuminated and non-illuminated versions with either incandescent bulbs or LEDs are available in either dependent or independent circuits and in a variety of popular switching circuits.

The NGR also offers a variety of rocker buttons and indicators with laser-etched or pad-printed icons, insertable lenses and adhesive-backed labels.

Features

- Sealing
Standard switch provides splash and dust resistance to IP42. The sealed version is sealed to IP67 when supplied with panel seal.
- Rocker
The standard actuator for the NGR is a clean, European-styled, two-face rocker made of high-quality thermoplastic material. The rocker is replaceable and snaps on and off the switch. Both the rocker and the bezel are supplied with an aesthetically pleasing matte finish. Different colors are also available, but black is standard. Rockers can be ordered separately.

Contents

<i>Description</i>	<i>Page</i>
NGR Rocker Switches	
Switch Base	V11-T2-10
Rocker Buttons/Actuators	V11-T2-11
Lens Selection	V11-T2-13
NGR Complete Indicators and Indicator Caps	V11-T2-14
NGR Indicator Base and Indicator Caps	V11-T2-15
Technical Data and Specifications	V11-T2-16
Standard Circuit Diagrams	V11-T2-17
Dimensions	V11-T2-30

- Lighting
Each switch is capable of accommodating two incandescent light bulbs or LEDs for lighting purposes. A lamp or LED can be located at either end of the switch and oriented to be circuit dependent or independent. The incandescent bulbs are front replaceable. Two lamp or LED voltages, 14 Vdc and 28 Vdc, are standard. For additional voltages or colors, consult your local Eaton Sales Representative.

Standards and Certifications

- Approvable under stringent UL and CSA standards
- For information, contact your local Eaton Sales Representative
- RoHS Compliant ^①



Note

^① Visit www.eaton.com/vcbu for the most up-to-date list of verified part numbers.

Options

- Circuits
 - 1PST, 1PDT, 2PST and 2PDT
 - Maintained and momentary action
- Common lamp ground jumper for dual lamp units
- Multiple LEDs for daylight readability
- Additional colors of rockers, mounting bezels and lenses are available
- Special circuits
- Special ratings
- Pad-printed legends on lens, rocker and bezel
- Special lamps and lamp voltages
- Dry circuit capabilities
- Custom back-lit legends available
- Reversing jumpers (internal)

- Gang mounting system, see **Page V11-T2-79**
- Locking rocker with locking feature in UP and/or DOWN positions
- Indicators with laser-etched or insertable lenses, or adhesive labels
- IP67 rated sealed switch
- Polarized lock-on connectors, see **Page V11-T2-78**
 - 28-5637-2 for Packard terminals
 - 28-5940 for AMP terminals
- Panel plug 17-21543
- Replacement bulb catalog number
 - 14V: 28-5901
 - 28V: 28-5909

For more information on additional options, contact your local Eaton Sales Representative.

Legends

Two legend areas are provided on the ends of each rocker of sufficient size to accommodate two lines consisting of four Helvetica Narrow 12-point characters. Legends may be non-illuminated or illuminated. The NGR offers three styles of illuminated legends.

Single-piece back-lit—Back-lighting is a high-quality automotive/truck industry technique. The legend can appear daylight white or dead-front when non-illuminated but, depending on the back-lit color chosen, will change color when illuminated. Examples of standard back-lit legends are found on **Pages V11-T2-82 to V11-T2-96**.

Snap-in lenses—This rocker will have either one or two snap-in lenses in the legend areas. Legends are typically pad-printed on the lens in black or white. Snap-in lenses are available in six standard colors and can be ordered separately.

Label rocker—This rocker has a one-piece adhesive-backed label inserted into a recessed area on the face of the button. Legends can be done in several colors and be illuminated or non-illuminated. Contact your local Eaton Sales Representative for suggested sources.

Flexible Ordering System

You can order assembled switches or the switch base and actuator separately.

Use the final code in the switch base catalog number, **Page V11-T2-10**, to denote assembly instructions.



To order rocker and switch base assembled, contact your local Eaton Sales Representative.

To order rocker buttons, see **Page V11-T2-11**.

To order lenses, see **Page V11-T2-13**.

To order indicator caps, see **Page V11-T2-15**. For a complete indicator, see **Page V11-T2-14**.

Catalog Number Selection

How To Order—Switch Base

To determine complete catalog number, start with the appropriate base prefix and add the appropriate code letters and/or numbers.

Example: NGR 1501 4 B N A 0 N

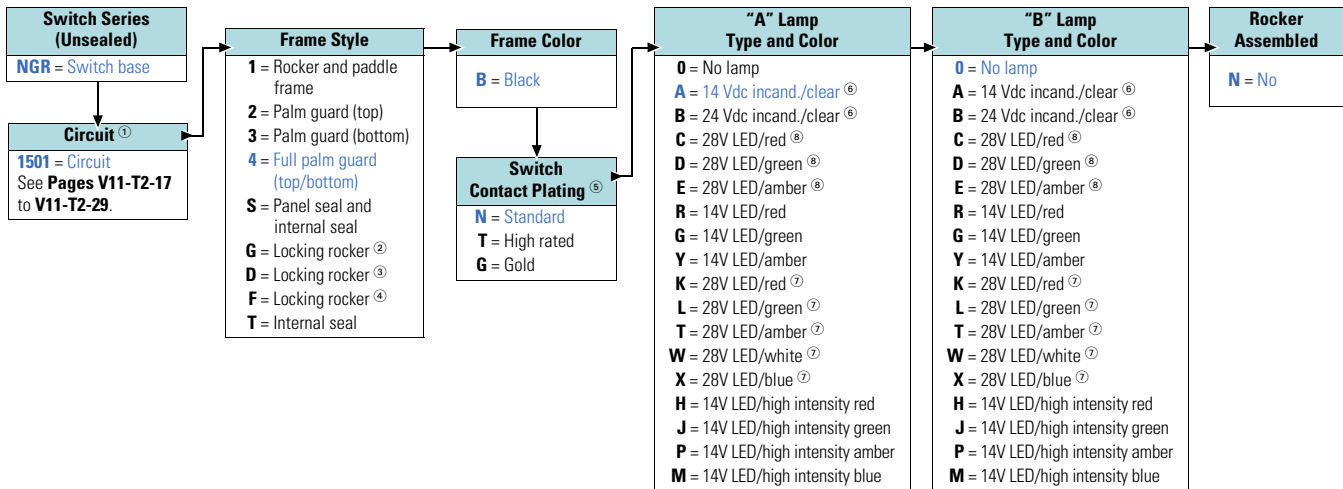

Notes

- ① Circuits show lighting options available. See **Pages V11-T2-17 to V11-T2-29**.
- ② Locks in DOWN position.
- ③ Locks in UP and DOWN positions.
- ④ Locks in UP position.
- ⑤ Switch contact construction plating—
 N = Standard: Recommended for use on loads up to 12 amps at 14 Vdc.
 T = High Rated: Recommended for use on loads greater than 12 amps at 14 Vdc.
 G = Gold: Recommended for use on dry circuit/low level switching.
- ⑥ Replaceable.
- ⑦ Replaceable/wedge base LED.
- ⑧ PCB version LED.

Rocker Buttons/Actuators



Catalog Number Selection

How To Order—Rocker Buttons/Actuators

To determine complete catalog number, start with the appropriate button type and add the appropriate code letters and/or numbers.

Example: **3 C A F A 1 B A E C 4 A 3**

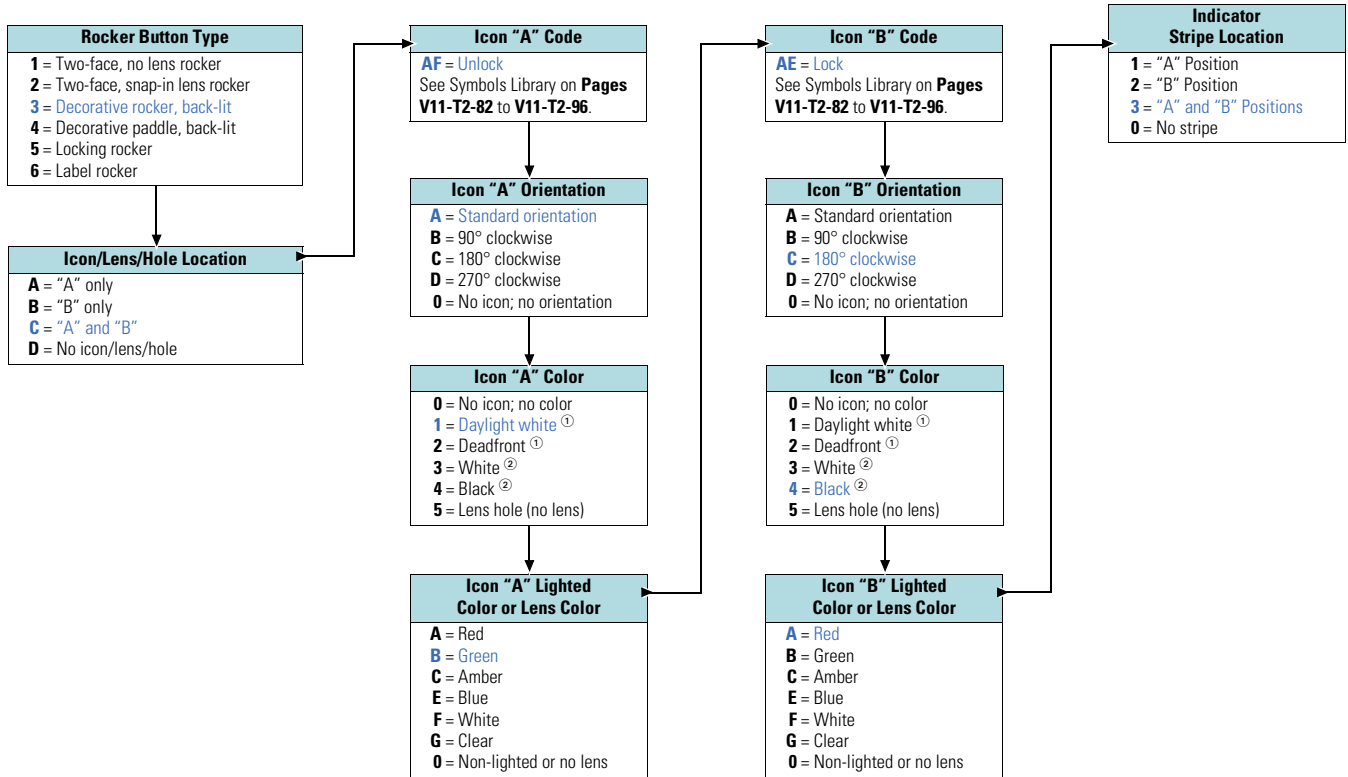

Notes
 ① Decorative rocker only.
 ② Two-face rocker only.

Icon Location Examples

Location A

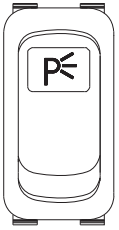

Rocker with Icon in "A" Position (Code A)

Location C

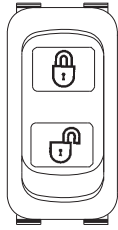

Rocker with Icon in "C" Position (Code C)

Location B

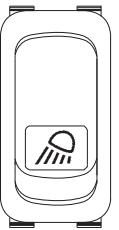

Rocker with Icon in "B" Position (Code B)

Icon Orientation Examples

Orientation A

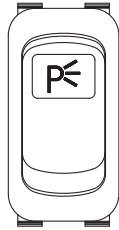

Rocker with Standard Orientation (Code A)

Orientation C

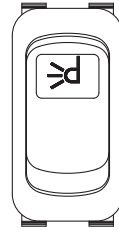

Rocker with Icon at 180° Clockwise (Code C)

Orientation B

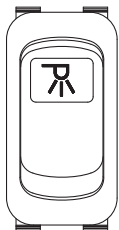

Rocker with Icon at 90° Clockwise (Code B)

Orientation D

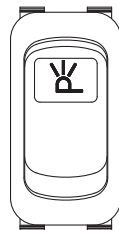

Rocker with Icon at 270° Clockwise (Code D)



Lens Selection

For NGR Rocker Type "2" and Indicator Type "2CAP" only.

Catalog Number Selection

How To Order—Translucent Lenses ①②

To determine complete catalog number, start with the appropriate base prefix and add the appropriate code letters and/or numbers.

Example: **28-5863-2 AF A**

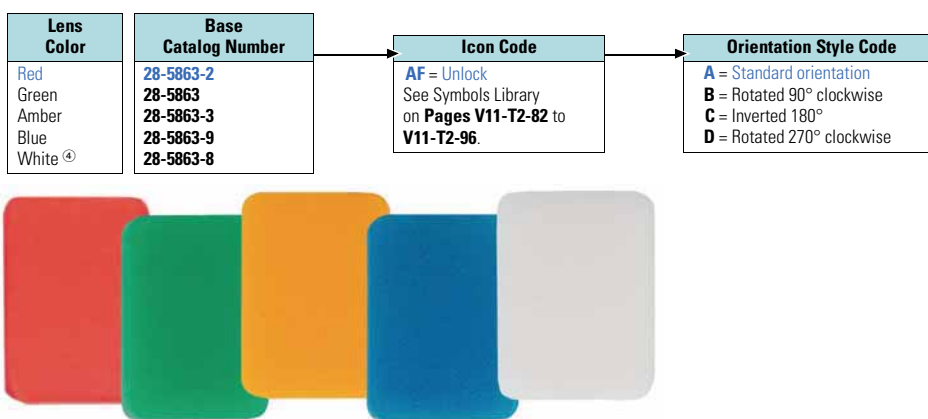

How To Order—Transparent Lenses ①②

To determine complete catalog number, start with the appropriate base prefix and add the appropriate code letters and/or numbers.

Example: **28-5863-5 AF A**

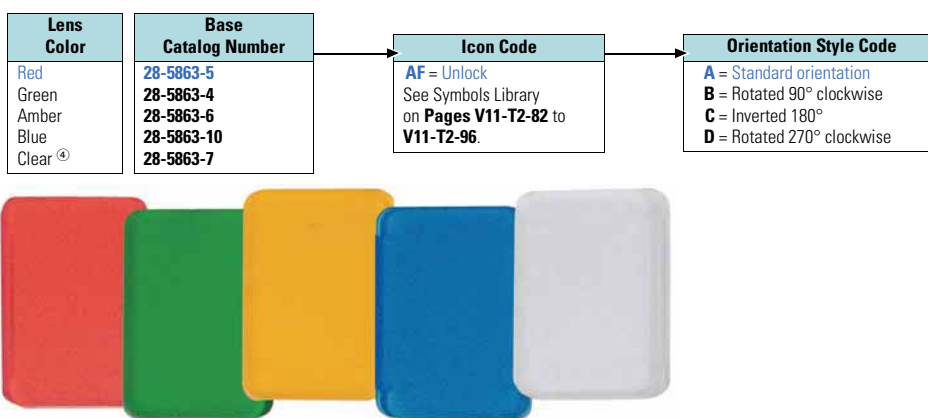

Notes

- ① When ordering a lens with an icon for the code **B** (bottom) position, specify code **C** orientation.
- ② Standard lens type.
- ③ Non-standard lens type.
- ④ Standard pad print for white and clear lens is black.

Complete Indicator and Indicator Cap Assembled

2



NGR Complete Indicators and Indicator Caps

To order rocker buttons, see **Page V11-T2-11**.

To order lenses, see **Page V11-T2-13**.

Catalog Number Selection

How To Order—Complete Indicator

To determine complete catalog number, start with the appropriate indicator type and add the appropriate code letters and/or numbers.

Example: **2N C AA R 1 B AB A 0 A**

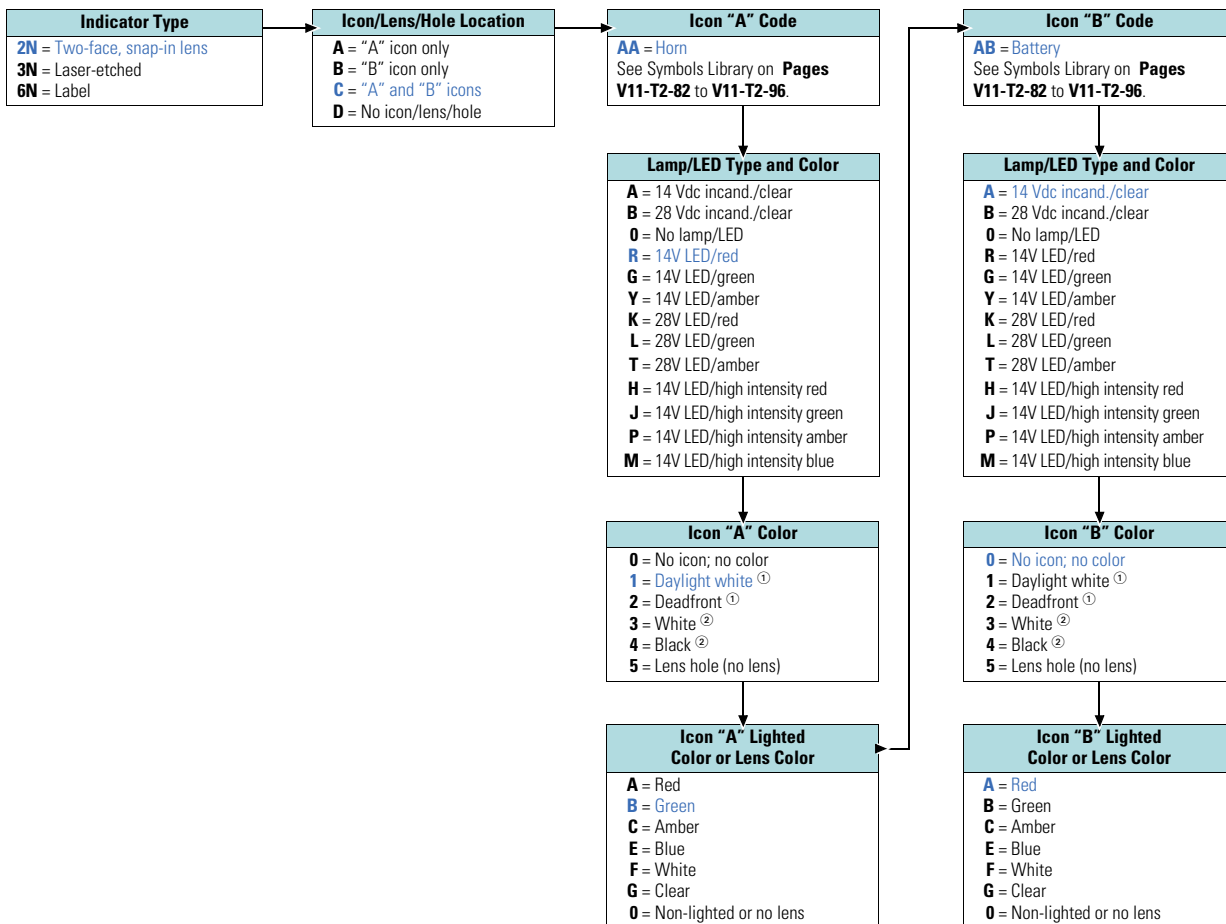

Notes

^① Decorative rocker only.

^② Two-face rocker only.



NGR Indicator Base and Indicator Caps

To order rocker buttons, see **Page V11-T2-11**.
 To order lenses, see **Page V11-T2-13**.
 To order complete indicator, see **Page V11-T2-14**.

Catalog Number Selection

How To Order—Indicator Base

To determine complete catalog number, start with the appropriate base prefix and add the appropriate code letters and/or numbers.

Example: NGRIND A 0 N

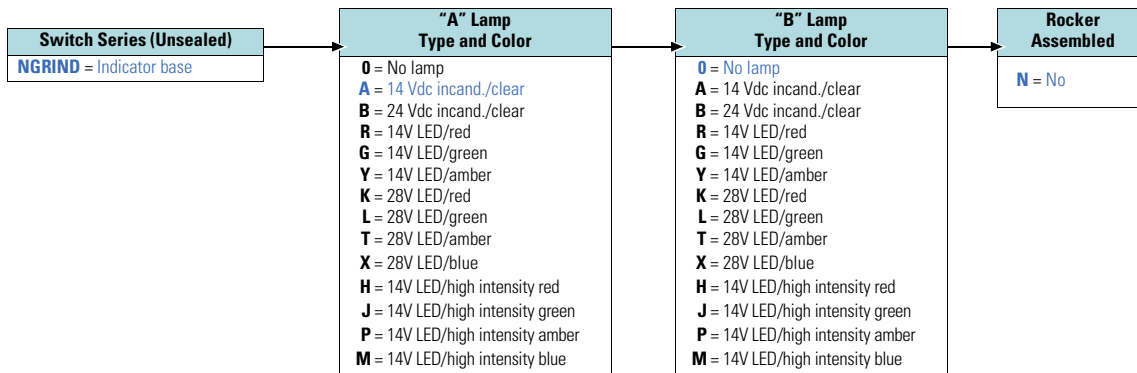

How To Order—Indicator Cap

To determine complete catalog number, start with the appropriate indicator type and add the appropriate code letters and/or numbers.

Example: 2CAP C AB 1 B AH 0 A

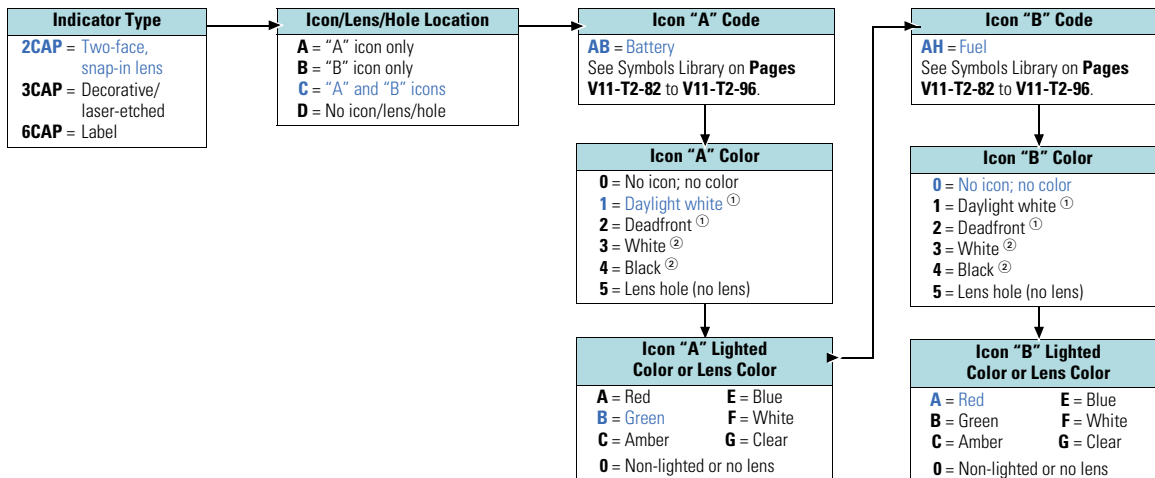

Notes
 ① Decorative rocker only.
 ② Two-face rocker only.

Technical Data and Specifications

2

NGR Rocker Switches

Description	Specification
Ratings ^①	15A at 125 Vac, 10A at 250 Vac 15A at 28 Vdc (14 Vdc rating) Approvable under stringent UL and CSA standards
Contact mechanism	Slow-make/slow-break contact mechanism Butt action contact mechanism designed specifically for use on AC and low voltage DC applications
Contact material— Standard construction	Movable—copper alloy with silver alloy contact face button Stationary—silver-plated copper alloy with silver alloy contact face button
Mechanical life	250,000 operations, minimum
Electrical life	200,000 operations, minimum
Terminal type	Standard 0.25 in (6.35 mm) spade, silver-plated copper alloy
Base material	High-grade thermoplastic molding material
Dielectric	1000V rms, minimum
Mounting means	Snap-in mounting with plastic bezel
Mounting hole	Rectangular panel cutout 1.734 x 0.867 in (44 x 22 mm)
Panel thickness	0.040 to 0.156 in (1.0 to 4.0 mm) ^{② ③}
IP rating	Standard IP42; sealed option IP67
Operating temperature range	–40° to 185°F (–40° to 85°C)

Notes

- ① For information, contact your local Eaton Sales Representative.
- ② Best results obtained between 0.060 and 0.118 in (1.5 and 3.0 mm).
- ③ On sealed versions, recommended panel thickness between 0.079 and 0.118 in (2.0 and 3.0 mm).

Standard Circuit Diagrams

Single-Pole

Circuit No.	Schematic (Shown in UP Position)	Circuit with Rocker In ...		
		DOWN Position	CENTER Position	UP Position
1001		OFF	NONE	ON
1501		OFF	NONE	ON
1502		OFF	NONE	ON
1503		OFF	NONE	ON
1504		OFF	NONE	ON
1505		OFF	NONE	ON
1506		OFF	NONE	ON
1507		OFF	NONE	ON
1508		OFF	NONE	ON

Two-Pole

Circuit No.	Schematic (Shown in UP Position)	Circuit with Rocker In ...		
		DOWN Position	CENTER Position	UP Position
2001		OFF	NONE	ON
2501		OFF	NONE	ON
2502		OFF	NONE	ON
2503		OFF	NONE	ON
2504		OFF	NONE	ON
2505		OFF	NONE	ON
2506		OFF	NONE	ON
2507		OFF	NONE	ON
2508		OFF	NONE	ON

2.2

Rockers

NGR Rocker Switches

Single-Pole

2

Circuit No.	Schematic (Shown in UP Position)	Circuit with Rocker In ...		
		DOWN Position	CENTER Position	UP Position
1002		OFF	NONE	MOM. ON 2B-3
1521		OFF	NONE	MOM. ON 2B-3-9
1522		OFF	NONE	MOM. ON 2B-3-10
1523		OFF	NONE	MOM. ON 2B-3
1524		OFF	NONE	MOM. ON 2B-3
1525		OFF	NONE	MOM. ON 2B-3-9
1526		OFF	NONE	MOM. ON 2B-3-10
1528		OFF	NONE	MOM. ON 2B-3

Two-Pole

Circuit No.	Schematic (Shown in UP Position)	Circuit with Rocker In ...		
		DOWN Position	CENTER Position	UP Position
2002		OFF	NONE	MOM. ON 2B-3 5B-6
2521		OFF	NONE	MOM. ON 2B-3-9 5B-6
2522		OFF	NONE	MOM. ON 2B-3-10 5B-6
2523		OFF	NONE	MOM. ON 2B-3 5B-6
2524		OFF	NONE	MOM. ON 2B-3 5B-6
2525		OFF	NONE	MOM. ON 2B-3-9 5B-6
2526		OFF	NONE	MOM. ON 2B-3-10 5B-6
2528		OFF	NONE	MOM. ON 2B-3 5B-6

Single-Pole

Circuit No.	Schematic (Shown in UP Position)	Circuit with Rocker In ...		
		DOWN Position	CENTER Position	UP Position
1003		ON	NONE	ON
		2B-1	—	2B-3
1541		ON	NONE	ON
		2B-1	—	2B-3-9
1542		ON	NONE	ON
		2B-1	—	2B-3-10
1543		ON	NONE	ON
		2B-1	—	2B-3
1544		ON	NONE	ON
		2B-1	—	2B-3
1545		ON	NONE	ON
		2B-1	—	2B-3-9
1546		ON	NONE	ON
		2B-1	—	2B-3-10
1547		ON	NONE	ON
		2B-1-10	—	2B-3-9
1548		ON	NONE	ON
		2B-1	—	2B-3

Two-Pole

Circuit No.	Schematic (Shown in UP Position)	Circuit with Rocker In ...		
		DOWN Position	CENTER Position	UP Position
2003		ON	NONE	ON
		2B-1	—	2B-3 5B-6
2541		ON	NONE	ON
		2B-1	—	2B-3-9 5B-6
2542		ON	NONE	ON
		2B-1	—	2B-3-10 5B-6
2543		ON	NONE	ON
		2B-1	—	2B-3 5B-6
2544		ON	NONE	ON
		2B-1	—	2B-3 5B-6
2545		ON	NONE	ON
		2B-1	—	2B-3-9 5B-6
2546		ON	NONE	ON
		2B-1	—	2B-3-10 5B-6
2547		ON	NONE	ON
		2B-1-10	—	2B-3-9 5B-6
2548		ON	NONE	ON
		2B-1	—	2B-3 5B-6

2.2

Rockers

NGR Rocker Switches

Single-Pole

2

Circuit No.	Schematic (Shown in UP Position)	Circuit with Rocker In ...		
		DOWN Position	CENTER Position	UP Position
1004		ON	OFF	ON
1561		ON	OFF	ON
1562		ON	OFF	ON
1563		ON	OFF	ON
1564		ON	OFF	ON
1565		ON	OFF	ON
1566		ON	OFF	ON
1567		ON	OFF	ON
1568		ON	OFF	ON

Two-Pole

Circuit No.	Schematic (Shown in UP Position)	Circuit with Rocker In ...		
		DOWN Position	CENTER Position	UP Position
2004		ON	OFF	ON
2561		ON	OFF	ON
2562		ON	OFF	ON
2563		ON	OFF	ON
2564		ON	OFF	ON
2565		ON	OFF	ON
2566		ON	OFF	ON
2567		ON	OFF	ON
2568		ON	OFF	ON

Single-Pole

Circuit No.	Schematic (Shown in UP Position)	Circuit with Rocker In ...		
		DOWN Position	CENTER Position	UP Position
1005		MOM. ON	OFF	MOM. ON
		2B-1	—	2B-3
1581		MOM. ON	OFF	MOM. ON
		2B-1	—	2B-3-9
1582		MOM. ON	OFF	MOM. ON
		2B-1	—	2B-3-10
1583		MOM. ON	OFF	MOM. ON
		2B-1	—	2B-3
1584		MOM. ON	OFF	MOM. ON
		2B-1	—	2B-3
1585		MOM. ON	OFF	MOM. ON
		2B-1	—	2B-3-9
1586		MOM. ON	OFF	MOM. ON
		2B-1	—	2B-3-10
1587		MOM. ON	OFF	MOM. ON
		2B-1-10	—	2B-3-9
1588		MOM. ON	OFF	MOM. ON
		2B-1	—	2B-3

Two-Pole

Circuit No.	Schematic (Shown in UP Position)	Circuit with Rocker In ...		
		DOWN Position	CENTER Position	UP Position
2005		MOM. ON	OFF	MOM. ON
		2B-1	—	2B-3
		5B-4	—	5B-6
2581		MOM. ON	OFF	MOM. ON
		2B-1	—	2B-3-9
		5B-4	—	5B-6
2582		MOM. ON	OFF	MOM. ON
		2B-1	—	2B-3-10
		5B-4	—	5B-6
2583		MOM. ON	OFF	MOM. ON
		2B-1	—	2B-3
		5B-4	—	5B-6
2584		MOM. ON	OFF	MOM. ON
		2B-1	—	2B-3
		5B-4	—	5B-6
2585		MOM. ON	OFF	MOM. ON
		2B-1	—	2B-3-9
		5B-4	—	5B-6
2586		MOM. ON	OFF	MOM. ON
		2B-1	—	2B-3-10
		5B-4	—	5B-6
2587		MOM. ON	OFF	MOM. ON
		2B-1-10	—	2B-3-9
		5B-4	—	5B-6
2588		MOM. ON	OFF	MOM. ON
		2B-1	—	2B-3
		5B-4	—	5B-6

2.2

Rockers

NGR Rocker Switches

Single-Pole

2

Circuit No.	Schematic (Shown in UP Position)	Circuit with Rocker In ...		
		DOWN Position	CENTER Position	UP Position
1006		ON	OFF	MOM. ON
		2B-1	—	2B-3
1601		ON	OFF	MOM. ON
		2B-1	—	2B-3-9
1602		ON	OFF	MOM. ON
		2B-1	—	2B-3-10
1603		ON	OFF	MOM. ON
		2B-1	—	2B-3
1604		ON	OFF	MOM. ON
		2B-1	—	2B-3
1605		ON	OFF	MOM. ON
		2B-1	—	2B-3-9
1606		ON	OFF	MOM. ON
		2B-1	—	2B-3-10
1607		ON	OFF	MOM. ON
		2B-1-10	—	2B-3-9
1608		ON	OFF	MOM. ON
		2B-1	—	2B-3

Two-Pole

Circuit No.	Schematic (Shown in UP Position)	Circuit with Rocker In ...		
		DOWN Position	CENTER Position	UP Position
2006		ON	OFF	MOM. ON
		2B-1	—	2B-3
		5B-4	—	5B-6
2601		ON	OFF	MOM. ON
		2B-1	—	2B-3-9
		5B-4	—	5B-6
2602		ON	OFF	MOM. ON
		2B-1	—	2B-3-10
		5B-4	—	5B-6
2603		ON	OFF	MOM. ON
		2B-1	—	2B-3
		5B-4	—	5B-6
2604		ON	OFF	MOM. ON
		2B-1	—	2B-3
		5B-4	—	5B-6
2605		ON	OFF	MOM. ON
		2B-1	—	2B-3-9
		5B-4	—	5B-6
2606		ON	OFF	MOM. ON
		2B-1	—	2B-3-10
		5B-4	—	5B-6
2607		ON	OFF	MOM. ON
		2B-1-10	—	2B-3-9
		5B-4	—	5B-6
2608		ON	OFF	MOM. ON
		2B-1	—	2B-3
		5B-4	—	5B-6

Single-Pole

Circuit No.	Schematic (Shown in UP Position)	Circuit with Rocker In ...		
		DOWN Position	CENTER Position	UP Position
1007		ON	NONE	MOM ON
		2B-1	—	2B-3
1621		ON	NONE	MOM ON
		2B-1	—	2B-3-9
1622		ON	NONE	MOM ON
		2B-1	—	2B-3-10
1623		ON	NONE	MOM ON
		2B-1	—	2B-3
1624		ON	NONE	MOM ON
		2B-1	—	2B-3
1625		ON	NONE	MOM ON
		2B-1	—	2B-3-9
1626		ON	NONE	MOM ON
		2B-1	—	2B-3-10
1627		ON	NONE	MOM ON
		2B-1-10	—	2B-3-9
1628		ON	NONE	MOM ON
		2B-1	—	2B-3

Two-Pole

Circuit No.	Schematic (Shown in UP Position)	Circuit with Rocker In ...		
		DOWN Position	CENTER Position	UP Position
2007		ON	NONE	MOM ON
		2B-1	—	2B-3 5B-6
2621		ON	NONE	MOM ON
		2B-1	—	2B-3-9 5B-6
2622		ON	NONE	MOM ON
		2B-1	—	2B-3-10 5B-6
2623		ON	NONE	MOM ON
		2B-1	—	2B-3 5B-6
2624		ON	NONE	MOM ON
		2B-1	—	2B-3 5B-6
2625		ON	NONE	MOM ON
		2B-1	—	2B-3-9 5B-6
2626		ON	NONE	MOM ON
		2B-1	—	2B-3-10 5B-6
2627		ON	NONE	MOM ON
		2B-1-10	—	2B-3-9 5B-6
2628		ON	NONE	MOM ON
		2B-1	—	2B-3 5B-6

Single-Pole

2

Circuit No.	Schematic (Shown in UP Position)	Circuit with Rocker In ...		
		DOWN Position	CENTER Position	UP Position
3003		OFF	ON	ON
3541		OFF	ON	ON
3542		OFF	ON	ON
3543		OFF	ON	ON
3544		OFF	ON	ON
3545		OFF	ON	ON
3546		OFF	ON	ON
3547		OFF	ON	ON
3548		OFF	ON	ON

Two-Pole

Circuit No.	Schematic (Shown in UP Position)	Circuit with Rocker In ...		
		DOWN Position	CENTER Position	UP Position
3004		OFF	ON	ON
3561		OFF	ON	ON
3562		OFF	ON	ON
3563		OFF	ON	ON
3564		OFF	ON	ON
3565		OFF	ON	ON
3566		OFF	ON	ON
3567		OFF	ON	ON
3568		OFF	ON	ON

Single-Pole

Circuit No.	Schematic (Shown in UP Position)	Circuit with Rocker In ...		
		DOWN Position	CENTER Position	UP Position
5001		ON	NONE	OFF
5501		ON	NONE	OFF
5502		ON	NONE	OFF
5503		ON	NONE	OFF
5504		ON	NONE	OFF
5505		ON	NONE	OFF
5506		ON	NONE	OFF
5507		ON	NONE	OFF
5508		ON	NONE	OFF

Two-Pole

Circuit No.	Schematic (Shown in UP Position)	Circuit with Rocker In ...		
		DOWN Position	CENTER Position	UP Position
5510		ON	NONE	OFF
5511		ON	NONE	OFF
5512		ON	NONE	OFF
5513		ON	NONE	OFF
5514		ON	NONE	OFF
5515		ON	NONE	OFF
5516		ON	NONE	OFF
5517		ON	NONE	OFF
5518		ON	NONE	OFF

2.2

Rockers

NGR Rocker Switches

Single-Pole

2

Circuit No.	Schematic (Shown in UP Position)	Circuit with Rocker In ...		
		DOWN Position	CENTER Position	UP Position
5002		MOM. ON	NONE	OFF
		2B-1	—	—
5521		MOM. ON	NONE	OFF
		2B-1-9	—	—
5522		MOM. ON	NONE	OFF
		2B-1-10	—	—
5523		MOM. ON	NONE	OFF
		2B-1	—	—
5524		MOM. ON	NONE	OFF
		2B-1	—	—
5525		MOM. ON	NONE	OFF
		2B-1-9	—	—
5526		MOM. ON	NONE	OFF
		2B-1-10	—	—
5528		MOM. ON	NONE	OFF
		2B-1	—	—

Circuit No.	Schematic (Shown in UP Position)	Circuit with Rocker In ...		
		DOWN Position	CENTER Position	UP Position
5003		ON	ON	OFF
		2A-1	2A-2B	2B-3
5541		ON	ON	OFF
		2A-1	2A-2B	2B-3-9
5542		ON	ON	OFF
		2A-1	2A-2B	2B-3-10
5543		ON	ON	OFF
		2A-1	2A-2B	2B-3
5544		ON	ON	OFF
		2A-1	2A-2B	2B-3
5545		ON	ON	OFF
		2A-1	2A-2B	2B-3-9
5546		ON	ON	OFF
		2A-1	2A-2B	2B-3-10
5547		ON	ON	OFF
		2A-1-10	2A-2B	2B-3-9
5548		ON	ON	OFF
		2A-1	2A-2B	2B-3

Two-Pole

Circuit No.	Schematic (Shown in UP Position)	Circuit with Rocker In ...			Circuit No.	Schematic (Shown in UP Position)	Circuit with Rocker In ...		
		DOWN Position	CENTER Position	UP Position			DOWN Position	CENTER Position	UP Position
3001		ON	ON	ON	3002		OFF	1-ON	2-ON
		5B-4-2B-1	5B-4-2B-3	2B-3 5B-6			2B-1 5B-4	2B-3 5B-4	2B-3 5B-6
3501		ON	ON	ON	3521		OFF	1-ON	2-ON
		5B-4-2B-1	5B-4-2B-3-9	2B-3-9 5B-6			2B-1 5B-4	2B-3-9 5B-4	2B-3-9 5B-6
3502		ON	ON	ON	3522		OFF	1-ON	2-ON
		5B-4-2B-1	5B-4-2B-3-10	2B-3-10 5B-6			2B-1 5B-4	2B-3-10 5B-4	2B-3-10 5B-6
3503		ON	ON	ON	3523		OFF	1-ON	2-ON
		5B-4-2B-1	5B-4-2B-3	2B-3 5B-6			2B-1 5B-4	2B-3 5B-4	2B-3 5B-6
3504		ON	ON	ON	3524		OFF	1-ON	2-ON
		5B-4-2B-1	5B-4-2B-3	2B-3 5B-6			2B-1 5B-4	2B-3 5B-4	2B-3 5B-6
3505		ON	ON	ON	3525		OFF	1-ON	2-ON
		5B-4-2B-1	5B-4-2B-3	2B-3 5B-6			2B-1 5B-4	2B-3-9 5B-4	2B-3-9 5B-6
3506		ON	ON	ON	3526		OFF	1-ON	2-ON
		5B-4-2B-1	5B-4-2B-3	2B-3 5B-6			2B-1 5B-4	2B-3-10 5B-4	2B-3-10 5B-6
3507		ON	ON	ON	3527		OFF	1-ON	2-ON
		5B-4-2B-1	5B-4-2B-3-9	2B-3-9 5B-6			2B-1-10 5B-4	2B-3-9 5B-4	2B-3-9 5B-6
3508		ON	ON	ON	3528		OFF	1-ON	2-ON
		5B-4-2B-1	5B-4-2B-3	2B-3 5B-6			2B-1 5B-4	2B-3 5B-4	2B-3 5B-6

Two-Pole

2

Circuit No.	Schematic (Shown in UP Position)	Circuit with Rocker In ...		
		DOWN Position	CENTER Position	UP Position
3005		MOM. ON	ON	MOM. ON
		2B-1 5B-4	2B-1 5B-6	2B-3 5B-6
3581		MOM. ON	ON	MOM. ON
		2B-1 5B-4	2B-1 5B-6	2B-3-9 5B-6
3582		MOM. ON	ON	MOM. ON
		2B-1 5B-4	2B-1 5B-6	2B-3-10 5B-6
3583		MOM. ON	ON	MOM. ON
		2B-1 5B-4	2B-1 5B-6	2B-3 5B-6
3584		MOM. ON	ON	MOM. ON
		2B-1 5B-4	2B-1 5B-6	2B-3 5B-6
3585		MOM. ON	ON	MOM. ON
		2B-1 5B-4	2B-1 5B-6	2B-3-9 5B-6
3586		MOM. ON	ON	MOM. ON
		2B-1 5B-4	2B-1 5B-6	2B-3-10 5B-6
3587		MOM. ON	ON	MOM. ON
		2B-1-10 5B-4	2B-1-10 5B-6	2B-3-9 5B-6
3588		MOM. ON	ON	MOM. ON
		2B-1 5B-4	2B-1 5B-6	2B-3 5B-6

Circuit No.	Schematic (Shown in UP Position)	Circuit with Rocker In ...		
		DOWN Position	CENTER Position	UP Position
4001		NONE	ON	MOM. ON
		2B-1 5B-4	2B-1 5B-4	2B-3 5B-6
4501		NONE	ON	MOM. ON
		2B-1 5B-4	2B-1 5B-4	2B-3-9 5B-6
4502		NONE	ON	MOM. ON
		2B-1 5B-4	2B-1 5B-4	2B-3-10 5B-6
4503		NONE	ON	MOM. ON
		2B-1 5B-4	2B-1 5B-4	2B-3 5B-6
4504		NONE	ON	MOM. ON
		2B-1 5B-4	2B-1 5B-4	2B-3 5B-6
4505		NONE	ON	MOM. ON
		2B-1 5B-4	2B-1 5B-4	2B-3-9 5B-6
4506		NONE	ON	MOM. ON
		2B-1 5B-4	2B-1 5B-4	2B-3-10 5B-6
4507		NONE	ON	MOM. ON
		2B-1-10 5B-4	2B-1-10 5B-4	2B-3-9 5B-6
4508		NONE	ON	MOM. ON
		2B-1 5B-4	2B-1 5B-4	2B-3 5B-6

Two-Pole

Circuit No.	Schematic (Shown in UP Position)	Circuit with Rocker In ...			Circuit No.	Schematic (Shown in UP Position)	Circuit with Rocker In ...		
		DOWN Position	CENTER Position	UP Position			DOWN Position	CENTER Position	UP Position
5004		ON	ON	OFF	5005		2-ON	1-ON	OFF
	2A-1 5A-4	2A-2B 5A-5B	2B-3 5B-6			2B-1 5B-4	2B-3 5B-4	2B-3 5B-6	
5561		ON	ON	OFF	5581		2-ON	1-ON	OFF
	2A-1 5A-4	2A-2B 5A-5B	2B-3-9 5B-6			2B-1 5B-4	2B-3-9 5B-4	2B-3-9 5B-6	
5562		ON	ON	OFF	5582		2-ON	1-ON	OFF
	2A-1 5A-4	2A-2B 5A-5B	2B-3-10 5B-6			2B-1 5B-4	2B-3-10 5B-4	2B-3-10 5B-6	
5563		ON	ON	OFF	5583		2-ON	1-ON	OFF
	2A-1 5A-4	2A-2B 5A-5B	2B-3 5B-6			2B-1 5B-4	2B-3 5B-4	2B-3 5B-6	
5564		ON	ON	OFF	5584		2-ON	1-ON	OFF
	2A-1 5A-4	2A-2B 5A-5B	2B-3 5B-6			2B-1 5B-4	2B-3 5B-4	2B-3 5B-6	
5565		ON	ON	OFF	5585		2-ON	1-ON	OFF
	2A-1 5A-4	2A-2B 5A-5B	2B-3-9 5B-6			2B-1 5B-4	2B-3-9 5B-4	2B-3-9 5B-6	
5566		ON	ON	OFF	5586		2-ON	1-ON	OFF
	2A-1 5A-4	2A-2B 5A-5B	2B-3-10 5B-6			2B-1 5B-4	2B-3-10 5B-4	2B-3-10 5B-6	
5567		ON	ON	OFF	5587		2-ON	1-ON	OFF
	2A-1-10 5A-4	2A-2B 5A-5B	2B-3-9 5B-6			2B-1-10 5B-4	2B-3-9 5B-4	2B-3-9 5B-6	
5568		ON	ON	OFF	5588		2-ON	1-ON	OFF
	2A-1 5A-4	2A-2B 5A-5B	2B-3 5B-6			2B-1 5B-4	2B-3 5B-4	2B-3-9 5B-6	
				6001		ON	NONE	ON	
						2A-2B-5A-5B- 10-1-4-3	—	3-6-1	

2.2

Rockers

NGR Rocker Switches

Dimensions

Approximate Dimensions in Inches (mm)

2

Switch Base with Rocker Button

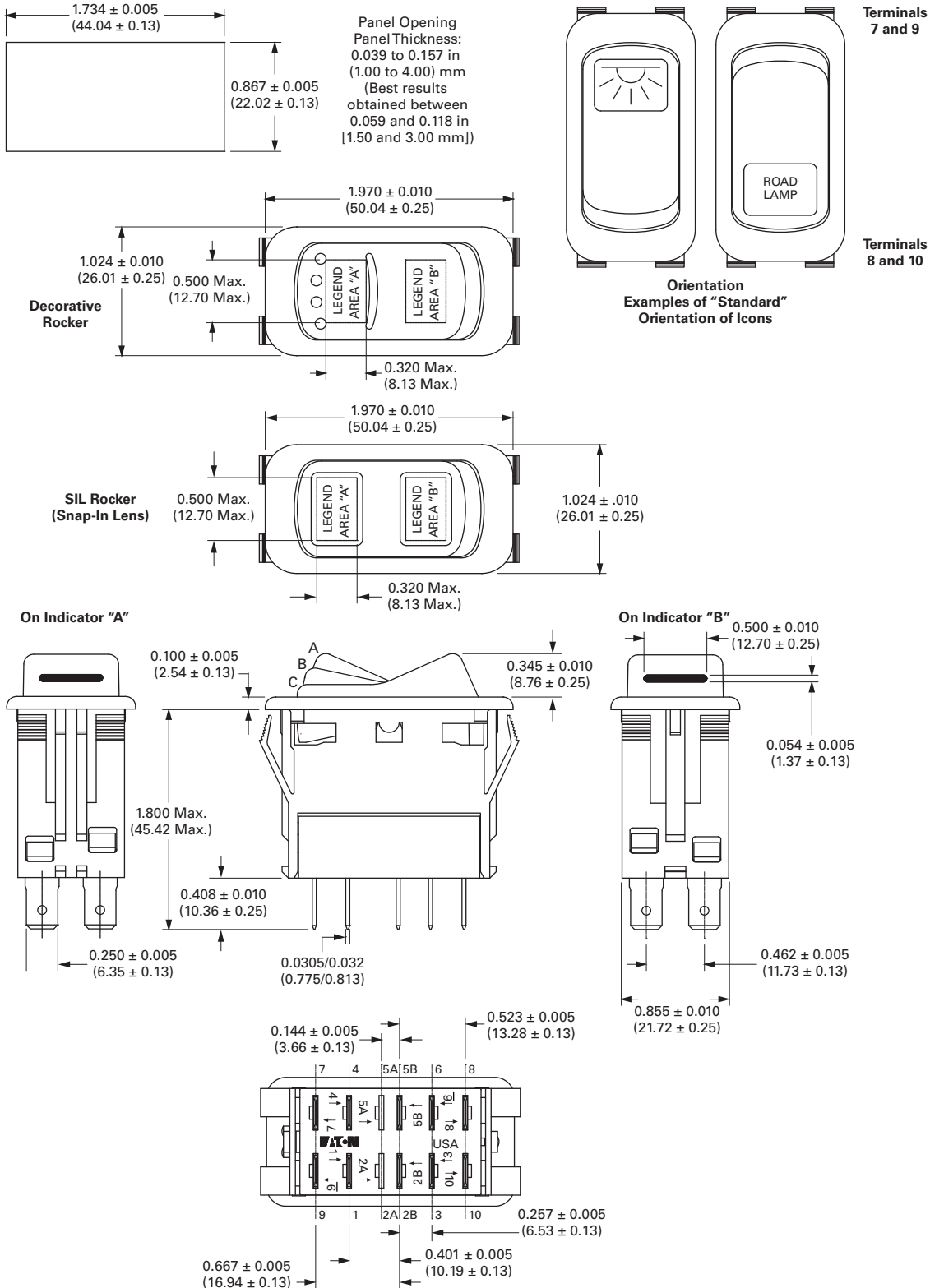

Approximate Dimensions in Inches (mm)

Locking Rocker

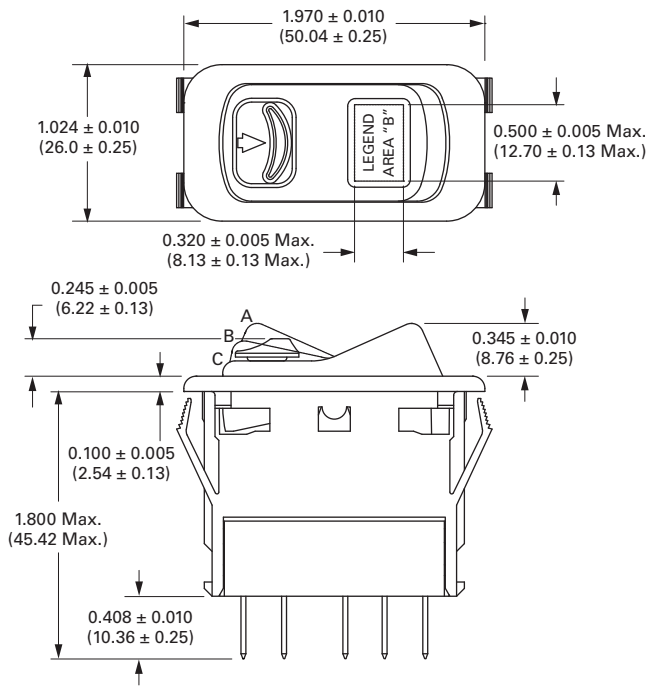

Sealed Rocker

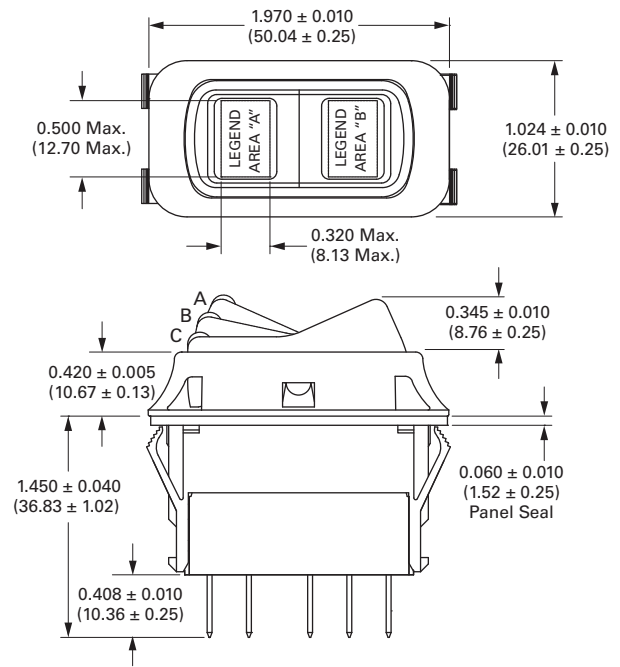

Indicator

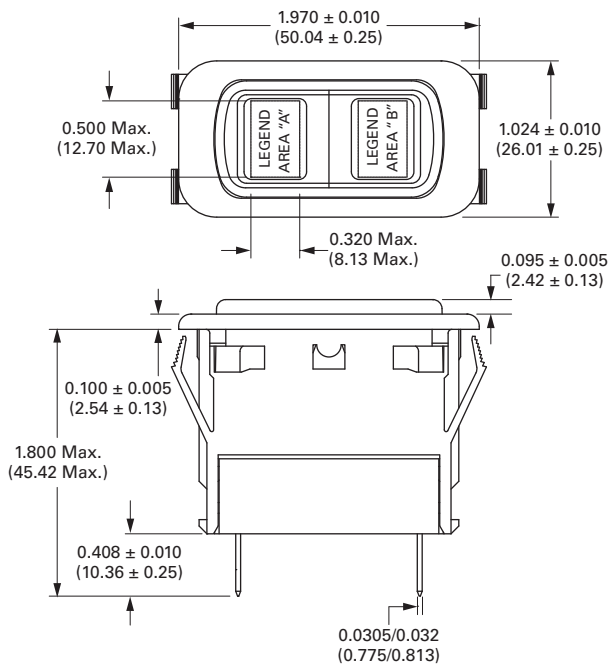

Label Rocker

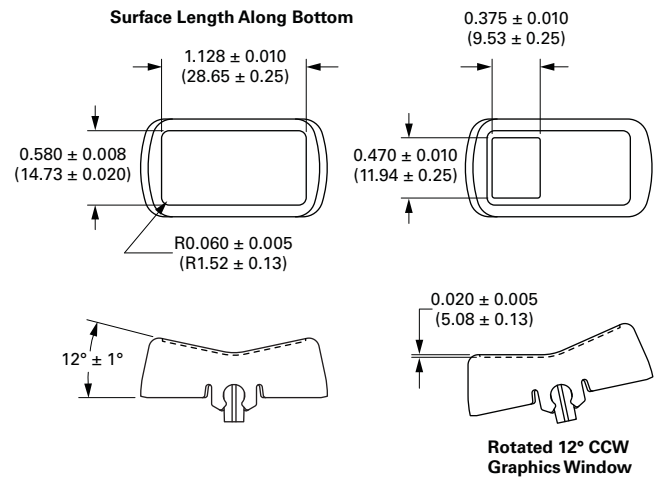

Note: Graphics window may be on both ends or either end of part. Dimensions shown are typical.

SVR—Sealed Vehicle Rocker

2



Product Description

The Sealed Vehicle Rocker (SVR) switch from Eaton’s electrical business now offers an above panel actuator style in addition to the below panel and paddle actuators. Designed to meet the severe environmental requirements of the construction and agricultural vehicle markets, the SVR is sealed at the front and back of the switch and meets the rigorous sealing requirements of IP68.

The small switch footprint minimizes the space taken on switch panels. SVR switches are assembled into panels by pressing the switch through the top of the panel and are held in place by retention tabs molded into the body of the switch; mounting hardware or special tools are not necessary.

The SVR is offered in single- and two-pole switch circuits, with two- and three-position momentary and maintained circuits available. Switch and illumination circuits are terminated with 0.11 in (2.8 mm) tin-plated copper alloy spade terminals. The SVR connector can be loaded with the appropriate terminals and/or wire seals to accomplish sealing at the back end of the switch.

Contents

Description

	<i>Page</i>
SVR—Sealed Vehicle Rockers	
Above-Panel Rocker Switch	V11-T2-34
Below-Panel Rocker Switch	V11-T2-35
Technical Data and Specifications	V11-T2-36
Circuit Diagrams	V11-T2-37
Dimensions	V11-T2-38

Features

You can order assembled switches or the switch base and actuator separately.

Use the final code in the switch base catalog number, **Pages V11-T2-34** and **V11-T2-35**, to denote assembly instructions.

Actuator

The SVR switch family includes three styles of actuators: above panel, below panel and paddle.

Switch performance and specifications are the same for all actuator styles. Black is standard, but other colors are also available. Matte finish is standard on all actuator styles, matching the finish on the bezels and all other visible SVR switch features and accessories.

Actuator Styles

- Above panel rocker button offers new styling and a larger surface area. Eaton can offer assistance with unique designs of above panel actuators for applications where differentiation is desired
- Below panel rocker button is the same two-faced European styling that has been offered for SVR since its initial release. Indicator style matches the below panel rocker button style
- Paddle actuator allows toggle-type actuation of the SVR switch

Standards and Certifications

- Approvable under stringent UL and CSA standards
- For information, contact your local Eaton Sales Representative
- RoHS Compliant ^①



Note

^① Visit www.eaton.com/vcbu for the most up-to-date list of verified part numbers.

Illumination

Long life LEDs provide backlighting illumination for the SVR switch. Backlighting can be either independent of or dependent on the switch circuits, or a combination of both. Standard LED color is amber, with red, green and blue also available. LED protection circuitry is available to protect the LED from overvoltage and reverse voltage conditions.

Contact your local Eaton Sales Representative for more specific information about standard and custom circuit options.

Backlighting

- Each switch can accommodate up to two LEDs that can be connected to be either circuit dependent or independent
- Standard LED color is amber, with red, green and blue also available. Long life (100,000 hours) LEDs are standard
- Standard LED voltages are 12 and 24 Vdc
- The below panel rocker button style includes a single-piece back-lit actuator with laser-etched icons in either daylight white or deadfront styles. Without illumination, the icon is either daylight white or deadfront, but will change to the color of the chosen light source when illuminated

Snap-in Lenses

- Above and below panel rocker buttons are available with or without one or two translucent lenses. Five standard lens colors are available: white, red, green, blue and amber

Icons

- Icon areas are provided on each end of the rocker button. Icons may be illuminated or non-illuminated and are pad-printed in a contrasting color either directly on the rocker button or the lens

Mounting Means

Snap-in mounting using four flexible plastic retainers integral with switch frame.

Circuits

The SVR switch is capable of single- or two-pole configurations with two- or three-position maintained, momentary or a combination of actuations.

The addition of jumpers between switch terminals expands the circuit possibilities.

Contact your local Eaton Sales Representative for more specific information about SVR standard and custom circuit options.

Standard Circuit Options

- ON–NONE–ON
- ON–OFF–ON
- ON*–OFF–ON*
- ON*–OFF–ON
- ON–ON–ON
- ON*–NONE–ON
- ON*–ON–ON*
- ON*–ON–ON

Note: * = Momentary. See Electrical Circuit Diagrams on Page V11-T2-37.

Sealing

SVR design includes a sealed contact chamber with dust and water resistance to IP68. The harness connection can also be sealed by using AMP wire seals Catalog Number 828905-1 (14–16 gauge) or 828904-1 (18–20 gauge) to seal the wires to the connector. For an application where a connector cavity is not being used, it can be sealed with AMP sealing plug Catalog Number 828922-1.

The above panel version may also be sealed to the panel using panel seal Catalog Number 32-2245.

Options

- Additional colors of actuators, mounting bezels and lenses
- Special circuits
- Special ratings
- Pad printing on the below panel switch bezel
- Low current capabilities
- Custom back-lit icons
- Gang-mount system including end bezel Catalog Number 17-22146 and center bezel 17-22152
- Palm Guard (below panel switch only) at either or both ends of the switch frame
- Indicators with insertable lenses
- Polarized lock-on connector Catalog Number 25-13936
- Panel plug with connector retention feature Catalog Number 17-22145
- Non-illuminated below panel paddle actuator

Note: Contact your local Eaton Sales Representative for additional information on options.

Above-Panel Rocker Switch

2



Catalog Number Selection

How To Order—Above-Panel SVR Switch

To determine complete catalog number, start with the appropriate switch series and add the appropriate code letters and/or numbers.

Example: S A C M 2 X D G A T R A V X X

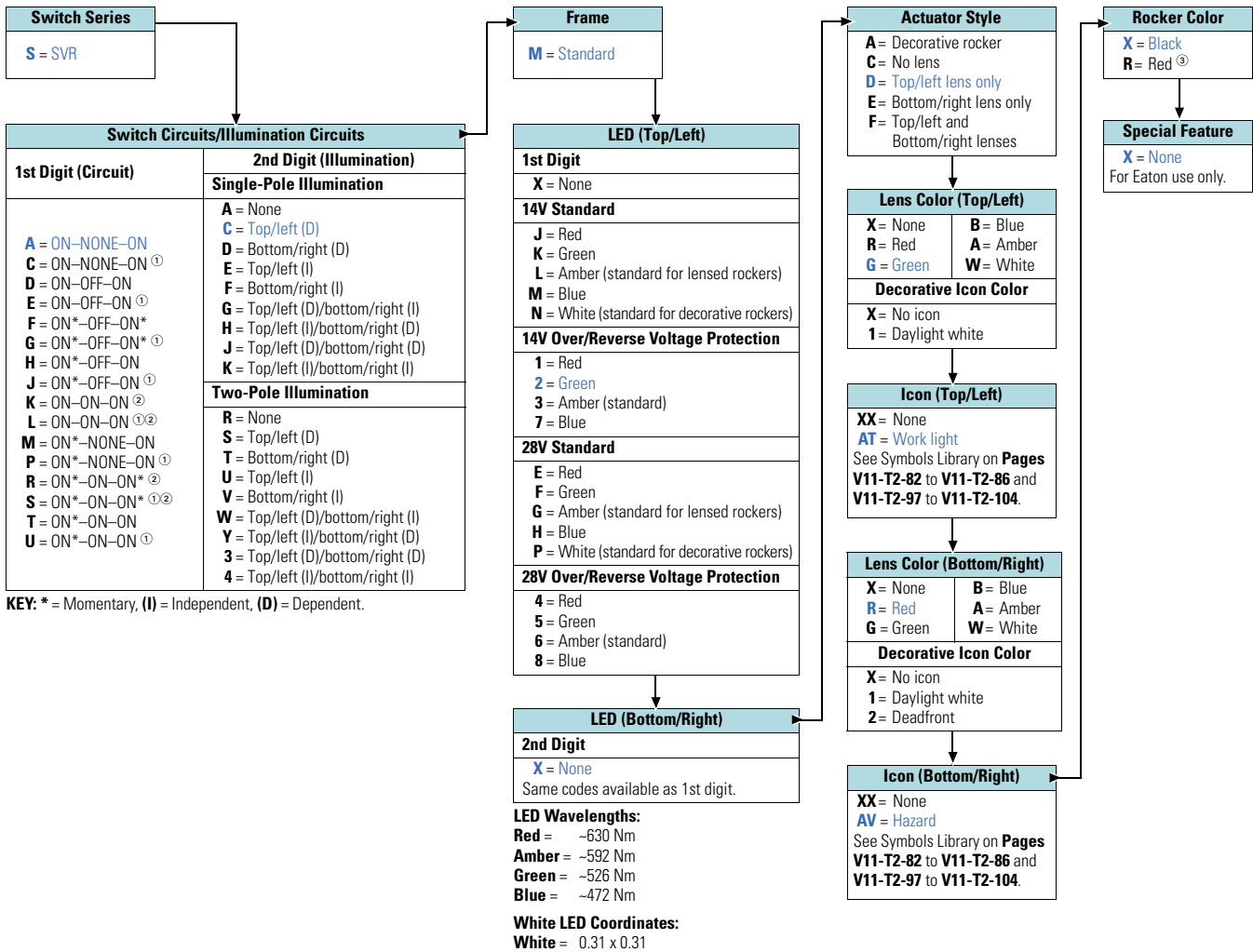

Notes

- ① Gold plated.
- ② Two-pole only. See Electrical Circuit Diagrams on Page V11-T2-37 and Illumination Circuit Diagrams on Page V11-T2-38.
- ③ For red rocker, only actuator style options A, C and F are available.



Below-Panel Rocker Switch

Catalog Number Selection

How To Order—Below-Panel Rocker Switch

To determine complete catalog number, start with the appropriate switch series and add the appropriate code letters and/or numbers.

Example: S AC S 2X 3 G AT R AC X X

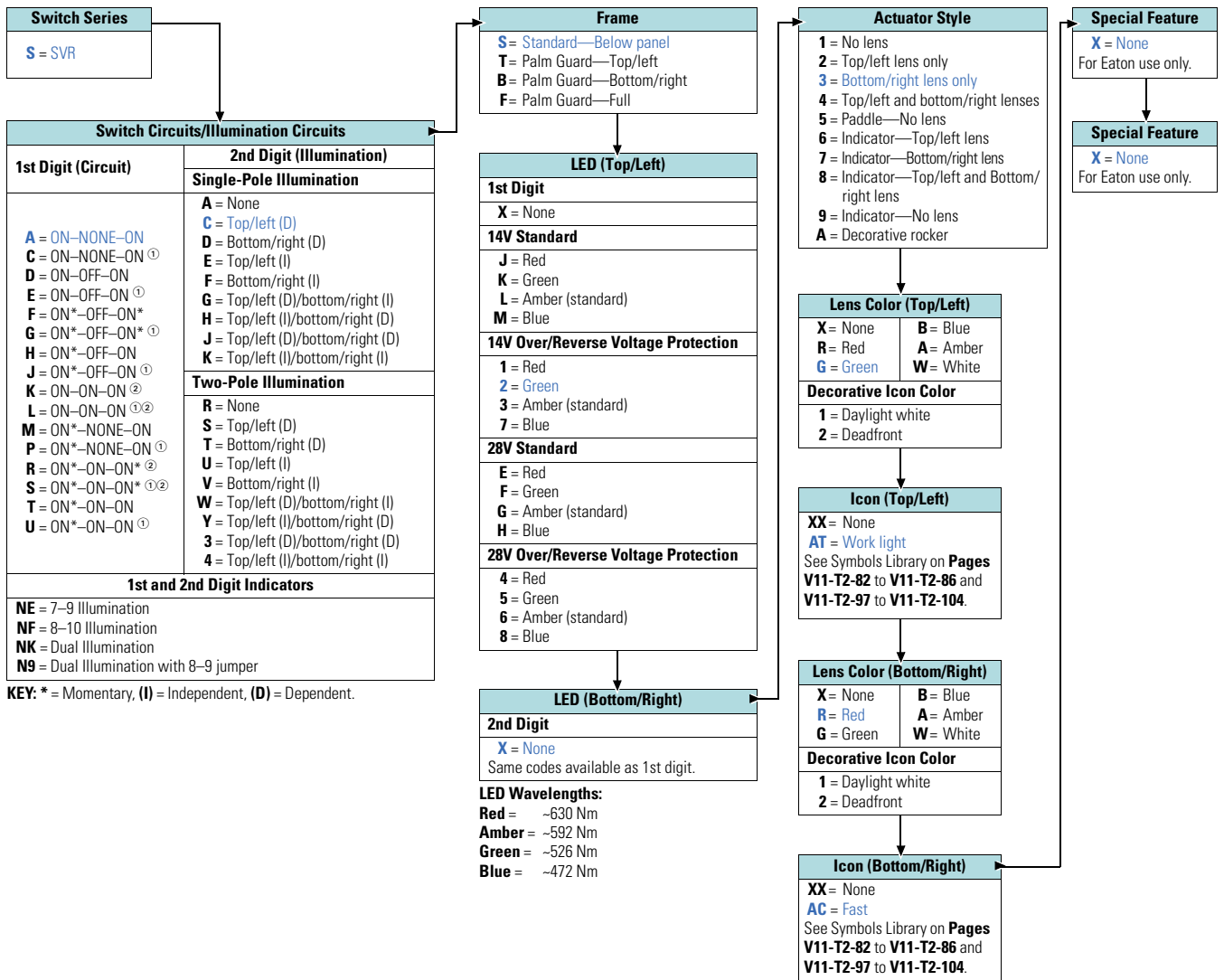

Notes

- ① Gold plated.
- ② Two-pole only. See Electrical Circuit Diagrams on Page V11-T2-37 and Illumination Circuit Diagrams on Page V11-T2-38.

Technical Data and Specifications

2

SVR—Sealed Vehicle Rocker

Description	Specification
Ratings	12A at either 12 or 24 Vdc, can be approved under stringent UL and CSA standards
Electrical life	
Standard plating	50,000 operations at 12A at either 12 or 24 Vdc. Life cycle testing conducted using both inductive and resistive loads
Gold plating	250,000 (maintained circuits)/50,000 (momentary circuits) operations at 10 mA at either 12 or 24 Vdc
Mechanical life	
Maintained circuits	250,000 operations minimum
Momentary circuits	50,000 operations minimum
Circuits	Single- or two-pole, two- or three-position, with momentary and maintained capabilities
Dielectric strength	1500 volts rms minimum
Operate force	1–3 lbs (4.4–13.2 Nm) depending on circuit configuration and actuator style
Temperature	
Operating range	–40° to 185°F (–40° to 85°C)
Storage range	–40° to 185°F (–40° to 85°C)
Contact material	
Movable	Copper alloy with silver alloy contact surface
Stationary	Silver-plated copper alloy with silver alloy contact surface
Gold-plated	Contacts are available for low level electrical loads
Terminal type	Standard 0.11 in (2.8 mm) tin-plated copper alloy spade terminal Mates to AMP Junior Power Timer Terminals ^① Catalog Number 927766-3 (14–16 gauge) Catalog Number 927770-3 (18–20 gauge)
Plastic component UL ratings	
Base material	UL 94 V-0
Frame material	UL 94 H-B
IP rating	IP68
Sub-actuator material	UL 94 V-0
Actuator material	UL 94 V-0 (above panel rocker button) UL 94 H-B (below panel rocker button and paddle actuator)
Mounting hole	Standard panel cutout of 1.45 x 0.83 in (36.8 x 21.1 mm)
Panel thickness	0.04 to 0.16 in (1.0 to 4.0 mm) Best results obtained between 0.06 and 0.12 in (1.5 and 3.0 mm)

Note

^① See also Sealing, **Page V11-T2-33**, for additional AMP components to seal the connector interface.

Circuit Diagrams

Switch Circuit Schematics

Code	Single-Pole Schematic (Shown in Top/left Actuated Position)	TOP/ LEFT Actuated	CENTER	BOTTOM/ RIGHT Actuated
A C (Gold)		ON	NONE	ON
		2-3	—	2-1
D E (Gold)		ON	OFF	ON
		2-3	—	2-1
F G (Gold)		MOM. ON	OFF	MOM. ON
		2-3	—	2-1
H J (Gold)		MOM. ON	OFF	ON
		2-3	—	2-1
K L (Gold)		Two-pole only		
M P (Gold)		MOM. ON	NONE	ON
		2-3	—	2-1
R S (Gold)		Two-pole only		
T U (Gold)		MOM. ON	ON	ON
		2-3	2-1	2-1

Code	Two-Pole Schematic (Shown in Top/left Actuated Position)	TOP/ LEFT Actuated	CENTER	BOTTOM/ RIGHT Actuated
A C (Gold)		ON	NONE	ON
		2-3	—	2-1
		5-6	—	5-4
D E (Gold)		ON	OFF	ON
		2-3	—	2-1
		5-6	—	5-4
F G (Gold)		MOM. ON	OFF	MOM. ON
		2-3	—	2-1
		5-6	—	5-4
H J (Gold)		MOM. ON	OFF	ON
		2-3	—	2-1
		5-6	—	5-4
K L (Gold)		ON	ON	ON
		2-3	5-4-2-3	5-4-2-1
		5-6		
M P (Gold)		MOM. ON	NONE	ON
		2-3	—	2-1
		5-6	—	5-4
R S (Gold)		MOM. ON	ON	MOM. ON
		2-3	5-4-2-3	5-4-2-1
		5-6		
T U (Gold)		MOM. ON	ON	ON
		2-3	2-1	2-1
		5-6	5-4	5-4

Illumination Schematics

Single-Pole Code	Two-Pole Code	Schematic ①
A	R	None
C	S	
D	T	
E	U	
F	V	
G	W	
H	Y	
J	3	
K	4	

Illumination Code	Schematic ①
9	

Note
 ① LED for terminals 7–9 is at top/left side of switch.
 LED for terminals 8–10 is at bottom/right of switch.

Dimensions

Above-Panel Rocker

Approximate Dimensions in Inches (mm)

Above-Panel (Pad-Printed) Rocker Switch

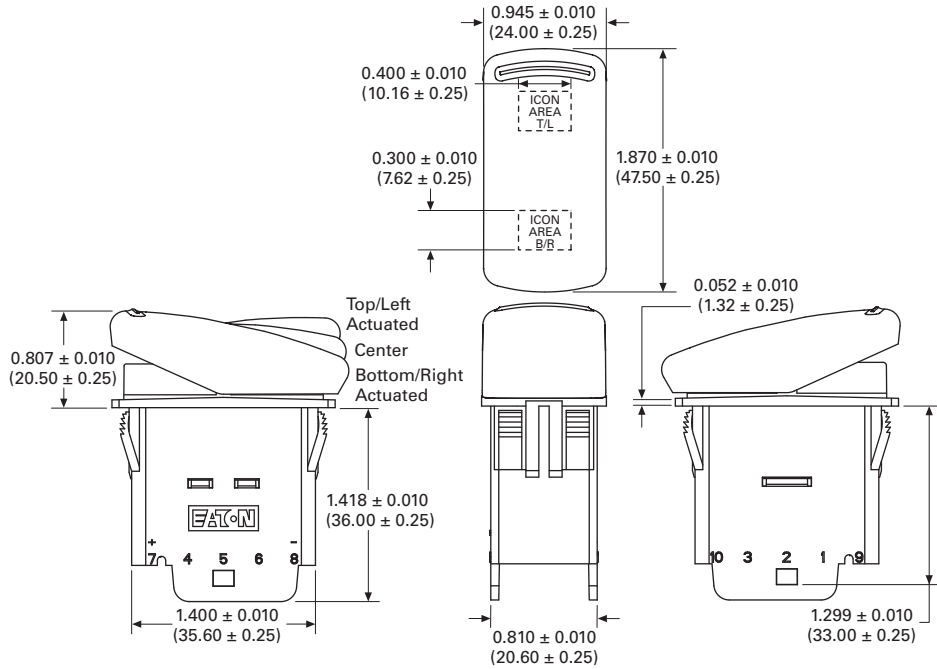

Above-Panel Decorative (Laser-Etched) Rocker Switch

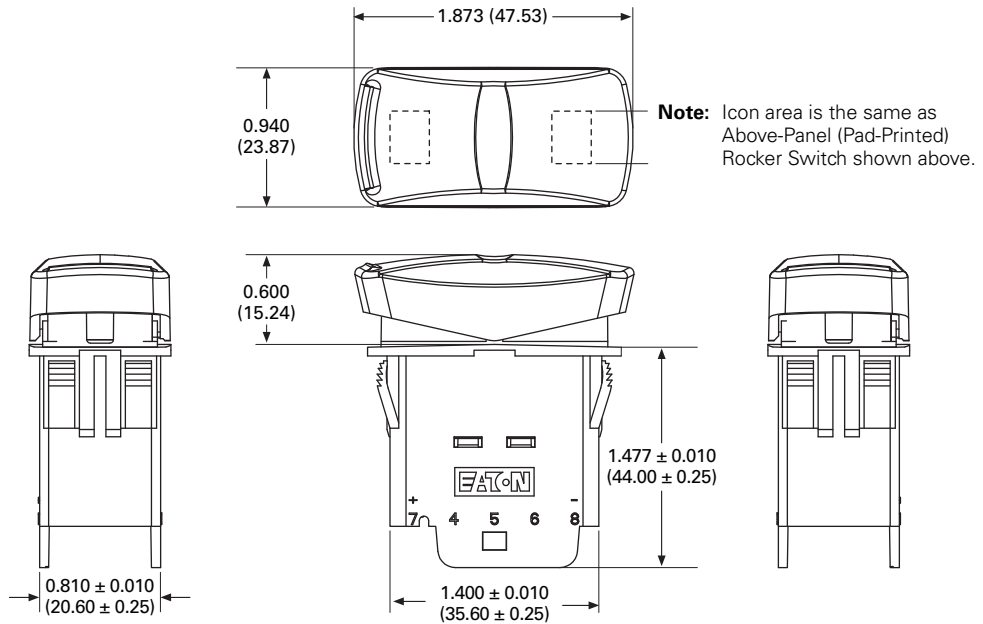

Above-Panel Rocker

Approximate Dimensions in Inches (mm)

Panel Seal Gasket (Above Only)

Catalog Number 32-2245

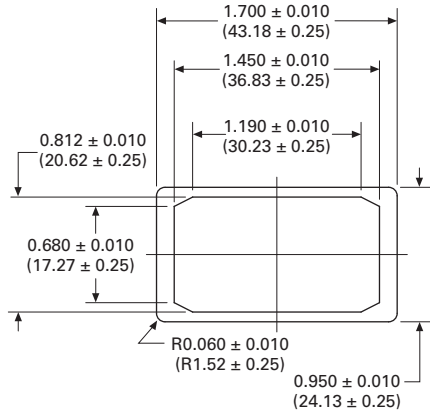

Panel Opening (Above and Below)

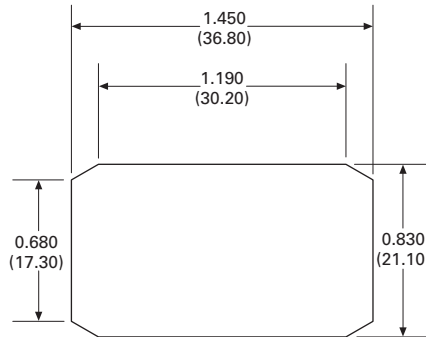

Note: Recommended panel thickness 0.039–0.157 in (1.00–4.00 mm). Best results obtained between 0.059 and 0.118 in (1.50 and 3.00 mm).

Below-Panel Rocker

Approximate Dimensions in Inches (mm)

2

Below-Panel Rocker Switch with Actuator

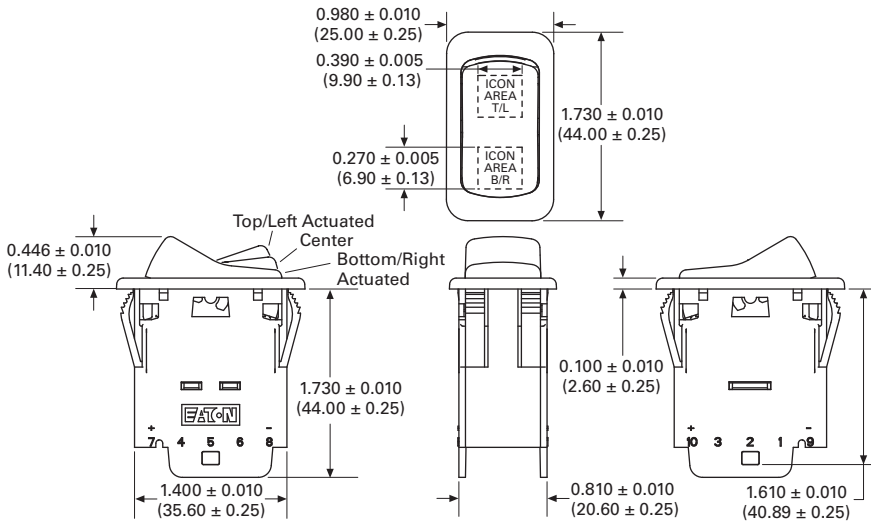

Panel Actuator (Below-Panel Only)

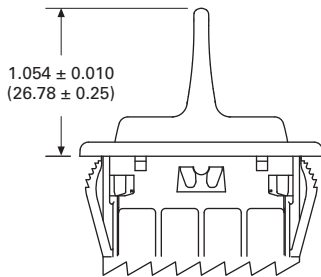

Panel Guard (Below-Panel Only)

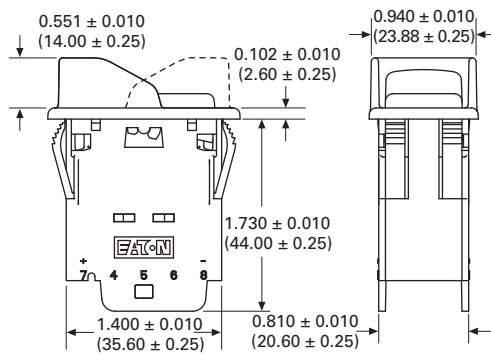

Below-Panel Rocker

Approximate Dimensions in Inches (mm)

Indicator (Below-Panel Only)

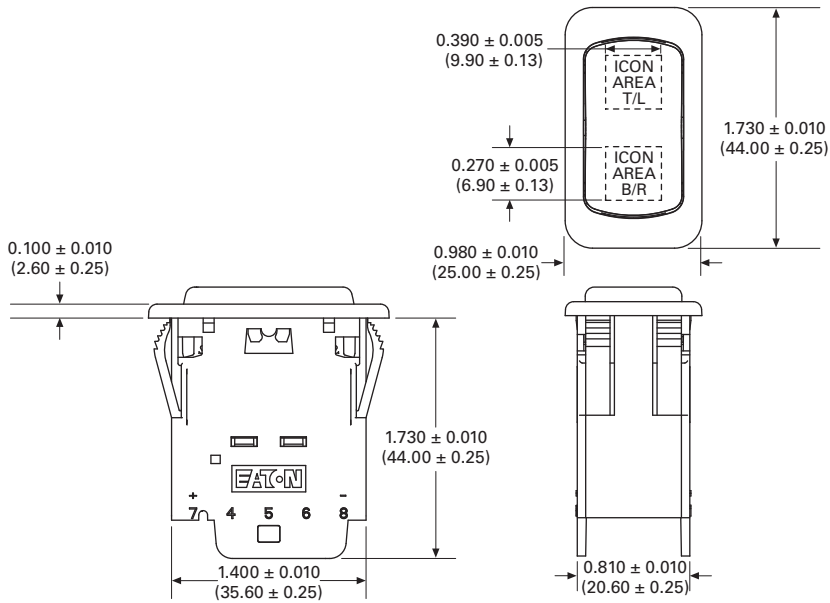

Accessories

Approximate Dimensions in Inches (mm)

2

Gang Mount System

End Bezel Catalog Number 17-22146

Center Bezel Catalog Number 17-22152

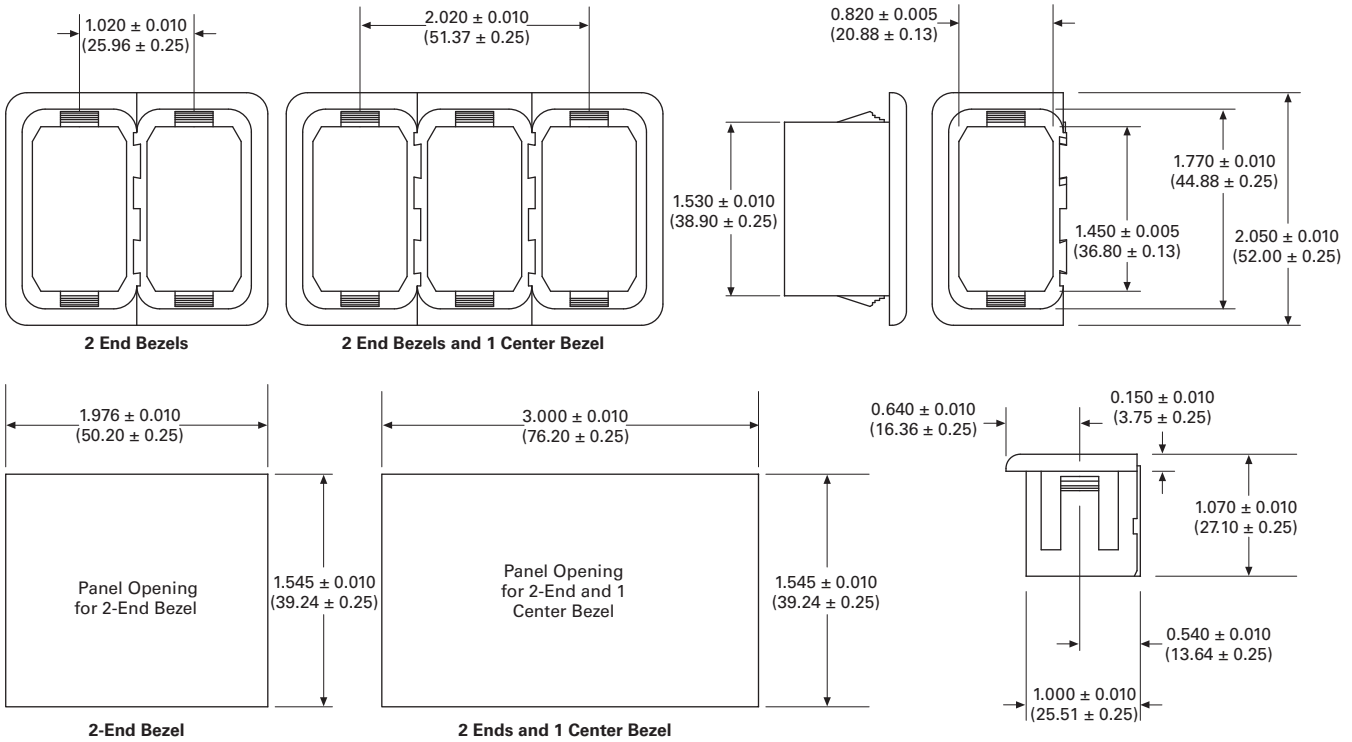

Panel Plug

Catalog Number 17-22145

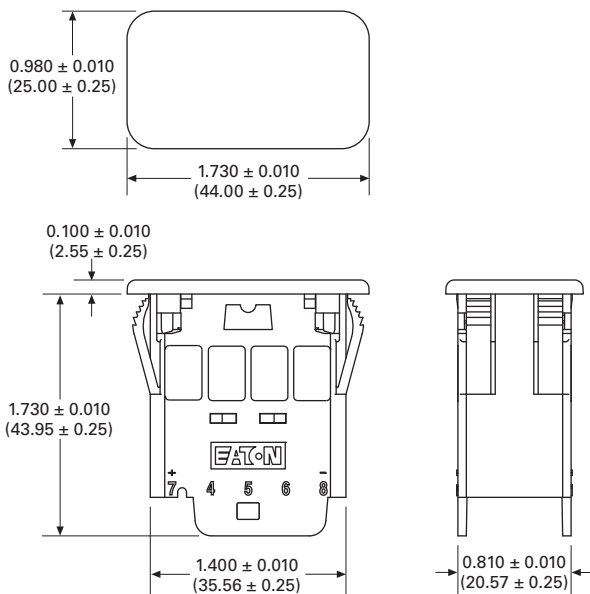

Connector

Catalog Number 25-13936

AMP Terminal Catalog Numbers:
 927766-3 (14–16 gauge)
 927770-3 (18–20 gauge)
 AMP Wire Seal Catalog Numbers:
 828905-1 (14–16 gauge)
 828904-1 (18–20 gauge)
 AMP Sealing Plug Catalog Number:
 828922-1

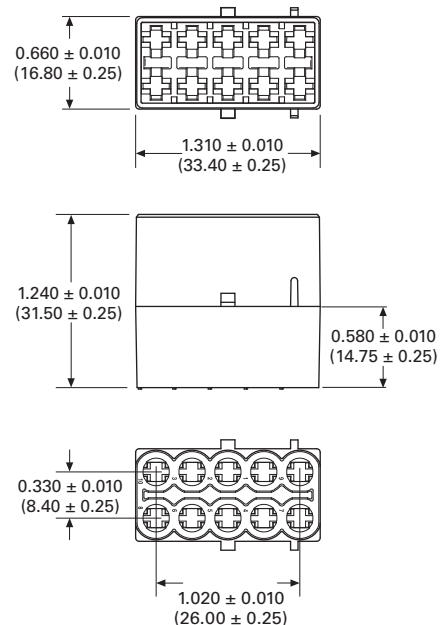

Dual Motion Safety Switch



Contents

Description

Page

Dual Motion Safety Switches	
Catalog Number Selection	V11-T2-44
Dimensions	V11-T2-44

Product Description

Eaton's Vehicle Control business offers these new dual motion safety switches to prevent accidental actuation and protect operator personnel and equipment.

These rockers are available in two standard circuit options: OFF (locked)—None—ON and ON (locked)—None—ON. The locked safety feature requires two motions from the operator to place the actuator in the unlocked position. In the locked position, the operator must apply pressure on the actuator forward and an additional force in an upward motion for the switch to be moved to the unlocked position. Once in the unlocked position, the switch can easily be moved back into the locked position.

Application Description

- Farming equipment
- Fire trucks and safety vehicles
- Lawn and garden equipment
- Large transportation buses
- Industrial and commercial equipment

Features and Benefits

Dual motion safety switches are recommended up to 15A at 28 Vdc. An added benefit is its IP54 seal level. They can be used in tough environments where there may be exposure to small dust particles or water splashing against the enclosure from any direction. For available higher ratings or additional customizable circuits, please contact your local Eaton Sales Representative.

Options

There are many options to choose when building the right switch for your application. Termination types to choose from include screw type, solder lug and 0.250-inch spade terminals. Actuators are available in four standard colors with an appealing matte finish. Choose from black, red, white or yellow. Eaton also offers standard and customizable legend pad printing options on top of the actuator. There is even an option for arrows to be pad printed on the sides of the rocker to indicate the correct forward motion.

For added convenience, the bezel is designed to allow an easy snap-in switch mount into various panel thicknesses. The actuators even have ergonomic grooves to help provide the operator a firm grip when moving the actuator.

Standards and Certifications

- UL/CSA Recognition at 15A, 125 Vac; 10A, 250 Vac; 3/4 hp, 250 Vac
- RoHS Compliant ①



Note

① Visit www.eaton.com/vcibu for the most up-to-date list of verified part numbers.

Catalog Number Selection

2

8179K21Z T 51 AA A Y

Poles and Throws	Circuit with Rocker In ...			Base Part Number
	Position A	Center Position	Position B	
2PST 2PDT	OFF (lock) ON (lock)	None None	ON ON	8179K21Z 8179K22Z

Rocker Color
Y = Black
T = Red
M = White
E = Yellow

Termination Type
50 = Screw type
51 = Solder lug
52 = Quick connect (0.250 in spade)

Top Pad Print ^①
XX = None
AA = PTO
AB = Creeper engage
AC = Retarder
AD = Windrower ON/OFF
AE = Rotary lock pin cylinder

Side Arrow Pad Prints
X = None
Y = Both sides

Icon Orientation
A = Standard
B = 90° clockwise
C = 180° clockwise
D = 270° counterclockwise
X = None

Available Switch Pad Prints

Prints^②

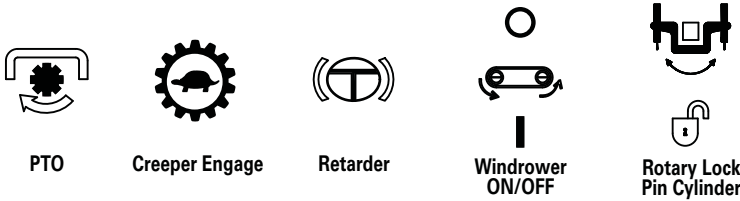

Dimensions

Approximate Dimensions in Inches (mm)

Dual Motion Safety Switch

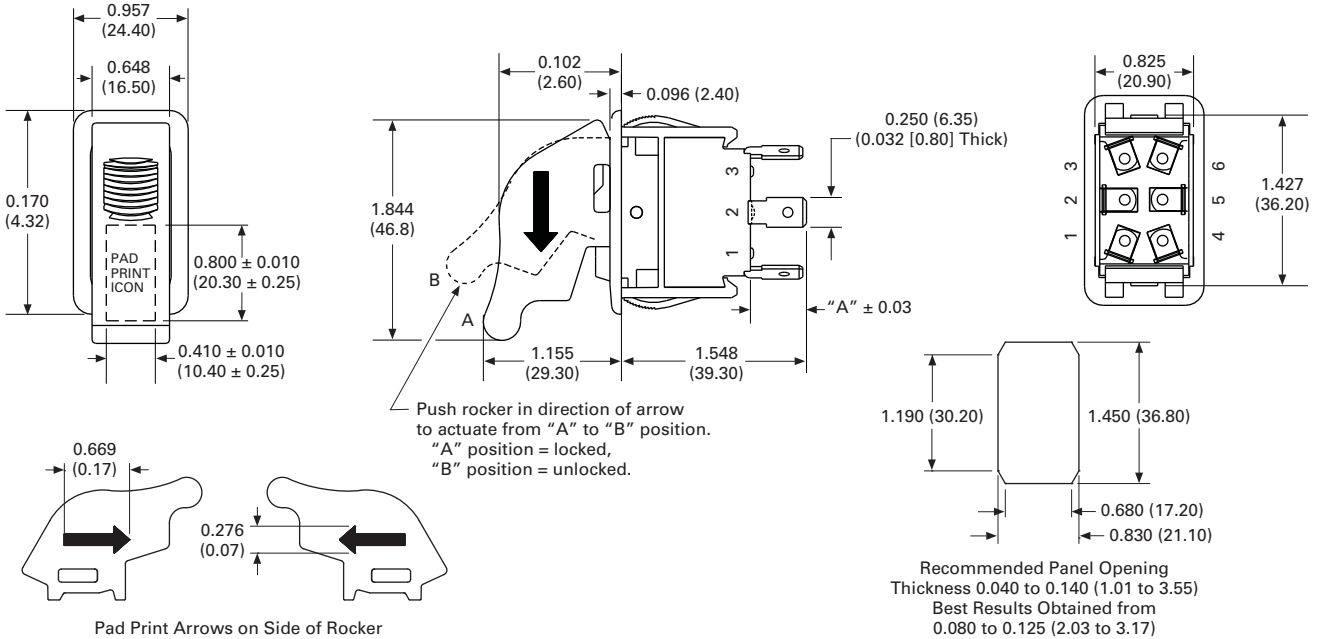

Notes

- ① Black pad print color for white and yellow rockers. White pad print color for red and black rockers.
- ② Contact your local Eaton Sales Representative for more available pad print options.

1500/2500 Series



Contents

<i>Description</i>	<i>Page</i>
1500/2500—Midsize AC Rated	
Midsize Non-Illuminated and Illuminated	V11-T2-46
Hi-Lite Rocker with High Inrush	V11-T2-47
Technical Data and Specifications	V11-T2-48
Dimensions	V11-T2-48

Product Description

Eaton’s 1500/2500 series rocker switch offers a designer touch that will enhance any product line.

Ideal applications include appliances, electronic instrumentation, data processing, communications and medical and office equipment. Custom legends are available on the switch actuator and bezel.

Options

High Inrush Option

The 1500H/2500H is designed to handle high inrush currents up to 100A peak inrush for 10 milliseconds.

Hi-Lite Rocker with High Inrush Option

This two-color rocker version brightly indicates the ON position. This version spares the expense of more costly illuminated switches and is available with the high inrush option.

Standards and Certifications

Note: See Catalog Number Selection for more detail.

International Approvals

- UL Recognized
- CSA Certified
- ENEC
- RoHS Compliant ①



Note

① Visit www.eaton.com/vcbu for the most up-to-date list of verified part numbers.

Midsize Non-Illuminated and Illuminated

To determine complete catalog number, start with the appropriate base circuit number and add the appropriate code letters and/or numbers.



2

Catalog Number Selection

How To Order—Midsize Non-Illuminated

Example: **1500** → **2 1 E 038**

Rating	Poles and Throw	Circuit with Rocker in ...			Base Circuit Number ^②	Circuit Number ^③
		UP Position	CENTER Position	DOWN Position ^①		
UL/CSA: 15A 125 Vac, 10A 250 Vac, 10A 28 Vdc, 8A 14VT; ENEC: 10(4)A 250V	1PST	ON MOM. ON ON	NONE NONE NONE	OFF OFF MOM. OFF	1500 1501 1505	1 3 4
	1PDT	ON ON	NONE NONE	ON MOM. ON	1502 1503	5 7
UL/CSA: 15A 125 Vac, 10A 250 Vac, 10A 28 Vdc, 8A 14VT; ENEC: 10(2)A 250V	1PDT	ON	OFF	ON	1504	6
UL/CSA: 10A 125 Vac, 10A 250 Vac, 10A 28Vdc, 8A 14VT; ENEC: 10(2)A 250V	1PDT	MOM. ON MOM. ON	OFF OFF	MOM. ON ON	1506 1507	9 8
	2PST	ON MOM. ON ON	NONE NONE NONE	OFF OFF MOM. OFF	2500 2501 2505	10 11 12
UL/CSA: 15A 125 Vac, 10A 250 Vac, 10A 28 Vdc, 8A 14VT; ENEC: 10(4)A 250V	2PDT	ON ON	NONE NONE	ON MOM. ON	2502 2503	13 15
	2PDT	ON	OFF	ON	2504	14
UL/CSA: 10A 125 Vac, 10A 250 Vac, 10A 28 Vdc, 8A 14VT; ENEC: 10(2)A 250V	2PDT	MOM. ON MOM. ON	OFF OFF	MOM. ON ON	2506 2507	17 16

Code letters and/or numbers.
Add to base circuit number.

Base and Bezel Color
1 = Black
2 = White
3 = Red

Rocker Color
1 = Black
2 = White
3 = Red

Terminal Type
E = 6.3 mm tabs/0.25 in quick connect
B = Solder lugs

Note: B style terminal not offered for 1506 Series.

Legend Type (Optional)
038 = ON/OFF
See Most Popular Legends table on Page V11-T2-55.

How To Order—Midsize Illuminated

Example: **2500** → **G 2 2 E 725**

Rating	Poles and Throw	Circuit with Rocker in ...			Base Circuit Number ^②	Circuit Number ^③
		UP Position	CENTER Position	DOWN Position ^①		
UL/CSA: 15A 125 Vac, 10A 250 Vac, 10A 28Vdc, 8A 14VT; ENEC: 10(4)A 250V	1PST	ON MOM. ON	NONE NONE	OFF OFF	1500 1501	18 21
	2PST	ON MOM. ON	NONE NONE	OFF OFF	2500 2501	28 30

Code letters and/or numbers.
Add to base circuit number.

Lens/Rocker Color
A = Amber
G = Green
R = Red
W = White (clear)

Lamp Voltage
0 = No lamp
1 = 125V neon
2 = 250V neon
4 = 6V filament^④
5 = 12V filament^④

Base and Bezel Color
1 = Black
2 = White
3 = Red

Terminal Type
E = 6.3 mm tabs/0.25 in quick connect
B = Solder lugs

Legend Type (Optional)
725 = ON/OFF
See Most Popular Legends table on Page V11-T2-55.

Notes

- ① 1500 Type—Lever depressed toward terminal #3. 2500 Type—Lever depressed toward terminals #13 and #26.
- ② #1500—#1507 switches are supplied in 1500 type base. #2500—#2507 switches are supplied in 2500 type base.
- ③ See Circuit Diagrams on Page V11-T2-80.
- ④ 6V, 12V filament lamps are not UL, CSA, or ENEC.



Hi-Lite Rocker with High Inrush

To determine complete catalog number, start with the appropriate base circuit type and add the appropriate code letters and/or numbers.

Catalog Number Selection

How To Order—Hi-Lite Rocker with High Inrush Option

Example: **1500H** → **1 2 4 E 038**

Rating	Poles and Throw	Circuit with Rocker in ...			Base Circuit Number	Circuit Number
		UP Pos.	CENTER Position	DOWN Position ①		
UL/CSA: 15A 125 Vac, 10A 250 Vac, 10A 28 Vdc, 8A 14VT; ENEC: 10(4)A 250V	1PST	ON MOM. ON	NONE	OFF	1500 _	1
	1PST	ON	NONE	OFF	1501 _	3
UL/CSA: 22A 125 Vac, 16A 250 Vac, 6A 125 VacL, 10A 14VT, 1 hp 125-250Vac; ENEC: 16(4)A 250V	1PST	ON	NONE	OFF	1500H ②	1
	2PST	ON	NONE	OFF	2500H	10

Code letters and/or numbers. Add to Base Circuit Number.

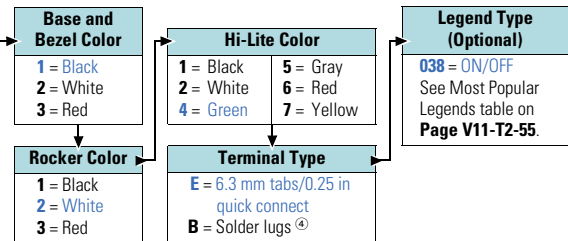

How To Order—High Inrush, Non-Illuminated

Example: **1500H** → **1 2 E 038**

Rating	Poles and Throw	Circuit with Rocker in ...			Base Circuit Number	Circuit Number
		UP Pos.	CENTER Position	DOWN Position ①		
UL/CSA: 22A 125 Vac, 16A 250 Vac, 6A 125 VacL, 10A 14VT, 1 hp 125-250 Vac; ENEC: 16(4)A 250V	1PST	ON	NONE	OFF	1500H	1
	2PST	ON	NONE	OFF	2500H	10

Code letters and/or numbers. Add to Base Circuit Number.

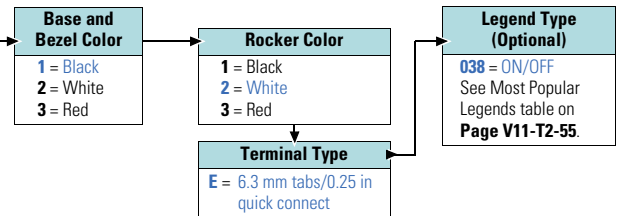

How To Order—High Inrush Illuminated

Example: **2500H** → **G 2 2 E 725**

Rating	Poles and Throw	Circuit with Rocker in ...			Base Circuit Number	Circuit Number
		UP Pos.	CENTER Position	DOWN Position ①		
UL/CSA: 22A 125 Vac, 16A 250 Vac, 6A 125 VacL, 10A 14VT, 1 hp 125-250 Vac; ENEC: 16(4)A 250V	1PST	ON	NONE	OFF	1500H	18
	2PST	ON	NONE	OFF	2500H	28

Code letters and/or numbers. Add to Base Circuit Number.

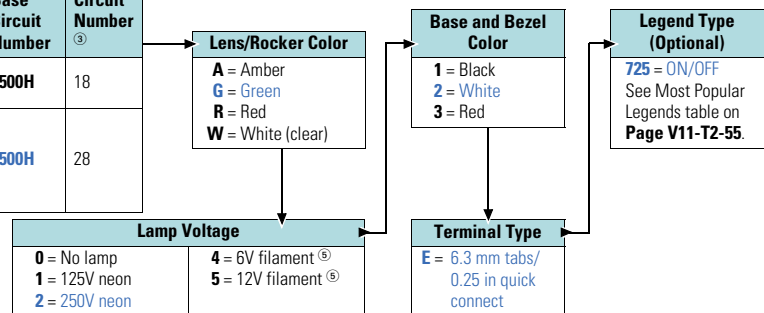

Notes

- ① 1500 Type—Lever depressed toward terminal #2. 1500H Type—Lever depressed toward terminal #3. 2500H Type—Lever depressed toward terminals #13 and #26.
- ② High inrush capabilities available only on basic catalog numbers beginning with 1500H.
- ③ See Circuit Diagrams on Page V11-T2-80.
- ④ Standard rating only.
- ⑤ 6V, 12V filament lamps are not UL, CSA, or ENEC.

Technical Data and Specifications

2

1500/2500—Midsize AC Rated

Description	Specification
Ratings	See selection tables on Pages V11-T2-46 and V11-T2-47.
Seal level	IP40
Circuits	
Standard	1PST, 1PDT, 2PST, 2PDT, maintained and momentary
High inrush option	1PST, 2PST, maintained
Hi-lite option	1PST, maintained
Contact mechanism	
Standard	Slow-make/slow-break butt contact
High inrush option	Slow-make/slow-break butt contact with mechanical break
Make—High inrush option	100A peak inrush at 250 Vac for 10 ms for 10,000 cycles minimum
Break—High inrush option	16A, 250 Vac for 10,000 cycles minimum
Contact material	Silver inlay over copper
Contact resistance	10M ohms max. at 1A, 4 Vdc

Description	Specification
Mechanical life	50,000 cycles minimum
Insulation resistance	50M ohms minimum
Dielectric withstand	1000V rms minimum
Terminal types	
Standard	6.3 mm Tabs/0.250 in Quick Connect
Optional	Solder lug
Termination material	
Common (center)	Copper fine silver-plated
End	Copper
Lamp	Brass
Mounting	See dimensions below
Operating temperature range	32° to 185°F (0° to 85°C)

Dimensions

Approximate Dimensions in Inches (mm)

1500/1500H Type Base

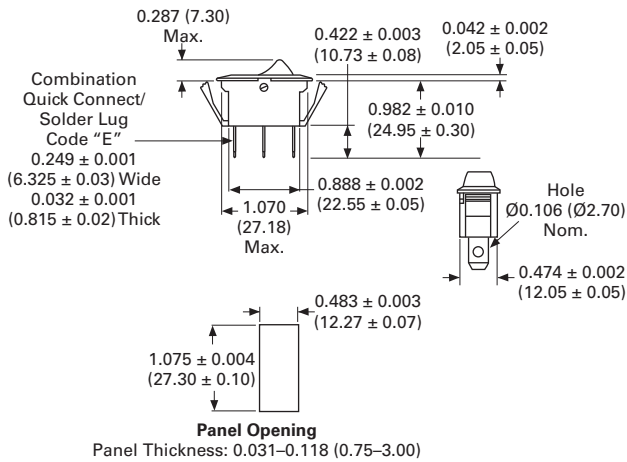
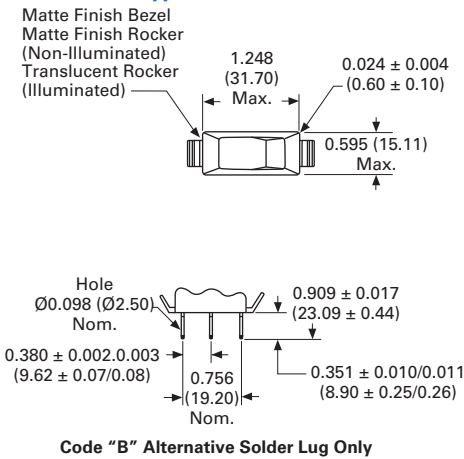

2500/2500H Type Base

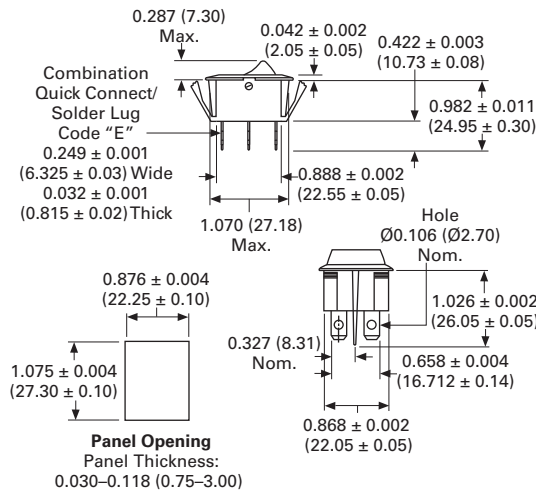
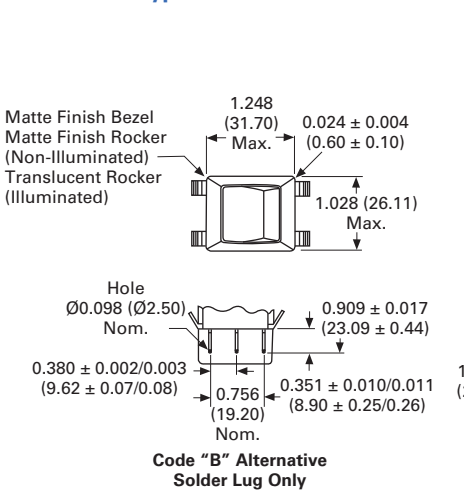

1600/2600 Series



Contents

<i>Description</i>	<i>Page</i>
1600/2600—Midsize AC Only	
Non-Illuminated Rocker	V11-T2-50
Illuminated Rocker	V11-T2-51
Splashguard	V11-T2-52
High Inrush Rockers	V11-T2-53
Technical Data and Specifications	V11-T2-54
Dimensions	V11-T2-54
Accessories	V11-T2-55
Legends	V11-T2-55

Product Description

Eaton’s 1600/2600 series of midsize snap-in rocker and paddle switches have worldwide approvals at up to 16A, 250 Vac. One switch can be used for both domestic and foreign markets.

Ideal applications include appliances, electronic instrumentation, data processing, communications, medical equipment, office equipment and many more. A wide circuit variety is offered in a choice of standard and custom colors for illuminated and non-illuminated versions. Custom legends are available on the switch lever and bezel. High inrush and splashguard are also available.

Options

High Inrush Option

The 1600H/2600H is designed to handle high inrush currents up to 100A peak inrush for 10 milliseconds.

Splashguard Option

This version features a uniquely designed seal that resists moisture and water, making it ideally suited for marine, RV and food processing applications. The oversized nylon lever with smooth, matte finish features a convenient thumb depression to ensure effortless touch control. Two-pole switches feature both a thumb depression and a convex curve. See **Page V11-T2-52**.

Standards and Certifications

Note: See Catalog Number Selection for more detail.

International Approvals

- UL Recognized
- CSA Certified ①
- ENEC
- RoHS Compliant ②



Notes

- ① Splashguard option is cRU marked only.
- ② Visit www.eaton.com/vcbu for the most up-to-date list of verified part numbers.



Non-Illuminated Rocker

To determine complete catalog number, start with the appropriate base circuit number and add the appropriate code letters and/or numbers.

Catalog Number Selection

How To Order—Non-Illuminated Rocker

Example: **1600** → **M 2 1 E 038**

Rating	Poles and Throw	Circuit with Rocker in ...			Base Circuit Number		Circuit Number ③
		UP Position	CENTER Position	DOWN Position ②	Rocker	Paddle ①	
UL/CSA: 16A 125–250 Vac, 10A 28 Vdc, 8A 14VT; ENEC: 16(4)A 250V	1PST	ON MOM. ON	NONE NONE NONE	OFF OFF MOM. OFF	1600 1601 1605	P1600 P1601 P1605	1 3 4
	1PDT	ON ON	NONE NONE	ON MOM. ON	1602 1603	P1602 P1603	5 7
UL/CSA: 16A 125–250 Vac, 10A 28 Vdc, 8A 14VT; ENEC: 10(2)A 250V	1PDT	ON	OFF	ON	1604	P1604	6
UL/CSA: 10A 125–250 Vac, 10A 28 Vdc, 8A 14VT; ENEC: 10(2)A 250V	1PDT	MOM. ON MOM. ON	OFF OFF	MOM. ON ON	1606 1607	P1606 P1607	9 8
		UL/CSA: 16A 125–250 Vac, 10A 28 Vdc, 8A 14VT; ENEC: 16(4)A 250V	2PST	ON MOM. ON ON	NONE NONE NONE	OFF OFF MOM. OFF	2600 2601 2605
UL/CSA: 16A 125–250 Vac, 10A 28 Vdc, 8A 14VT; ENEC: 16(4)A 250V	2PDT	ON ON	NONE NONE	ON MOM. ON	2602 2603	P2602 P2603	13 15
		UL/CSA: 16A 125–250 Vac, 10A 28 Vdc, 8A 14VT; ENEC: 10(2)A 250V	2PDT	ON	OFF	ON	2604
UL/CSA: 10A 125–250 Vac, 10A 28 Vdc, 8A 14VT; ENEC: 10(2)A 250V	2PDT	MOM. ON MOM. ON	OFF OFF	MOM. ON ON	2606 2607	P2606 P2607	17 16

Code letters and/or numbers.
Add to base circuit number.

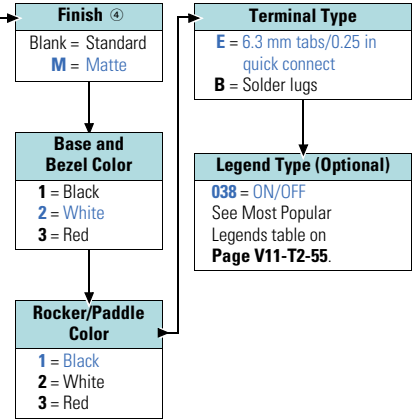

Notes

- ① Paddles are UL, CSA only.
- ② 1600 Type—Lever depressed toward terminal #3.
2600 Type—Lever depressed toward terminals #13 and #26.
- ③ See Circuit Diagrams on **Page V11-T2-80**.
- ④ To order the standard, add a "dash" to the catalog number. Example: 1600–11E.



Illuminated Rocker

To determine complete catalog number, start with the appropriate base circuit number and add the appropriate code letters and/or numbers.

Catalog Number Selection

How To Order—Illuminated Rocker

Example: **1621 X** → **W 5 3 E 038**
 X = Independent lamp

Rating	Poles and Throw	Circuit with Rocker in ...			Base Circuit Number ②	Circuit Number ③
		UP Position	CENTER Position	DOWN Position ①		
UL/CSA: 16A 125–250 Vac, 10A 28 Vdc, 8A 14VT; ENEC: 16(4)A 250V	1PST	ON	NONE	OFF	1600 1601 1620X 1621X 1625X	18
		MOM. ON	NONE	OFF		21
	1PDT	ON	NONE	OFF	1622X 1623X	20
		MOM. ON	NONE	MOM. OFF		④
	1PDT	ON	NONE	ON	1624X	④
		ON	NONE	MOM. ON		④
UL/CSA: 10A 125–250 Vac, 10A 28 Vdc, 8A 14VT; ENEC: 10(2)A 250V	1PDT	MOM. ON	OFF	MOM. ON	1626X 1627X	④
		MOM. ON	OFF	ON		④
UL/CSA: 16A 125–250 Vac, 10A 28 Vdc, 8A 14VT; ENEC: 16(4)A 250V	2PST	ON	NONE	OFF	2600 2601 2605	28
		MOM. ON	NONE	OFF		30
		ON	NONE	MOM. OFF		31
—	—	Indicator	—	—	1609	32

Code letters and/or numbers.
 Add to base circuit number.

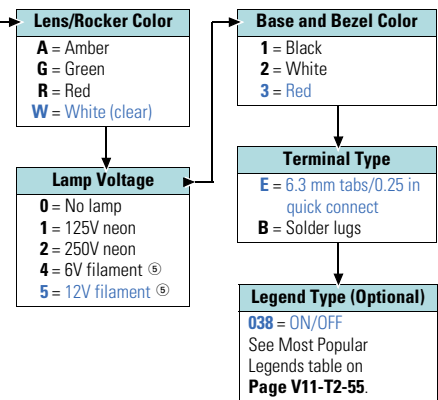

Notes

- ① 1600 Type—Lever depressed toward terminal #3.
 2600 Type—Lever depressed toward terminals #13 and #26.
- ② #1600—#1609 switches are supplied in 1600 type base.
 #1620—#1627 switches are supplied in 2600 type base. (Must have an “X” code.)
 #2600—#2605 switches are supplied in 2600 type base.
- ③ See Circuit Diagrams on **Page V11-T2-80**.
- ④ All independent lamps for IP switches to be assembled from terminal positions #24 and #26.
- ⑤ 6V, 12V filament lamps are not UL, CSA, or ENEC.

2.6

Rockers

1600/2600—Midsize AC Only

2



Splashguard

To determine complete catalog number, start with the appropriate base circuit number and add the appropriate code letters and/or numbers.

Catalog Number Selection

How To Order—Splashguard^①

Example: **B1600** → **1 2 E**

Rating ^②	Poles and Throw	Circuit with Rocker in ...			Base Circuit Number	Circuit Number ^③
		UP Position	CENTER Position	DOWN Position		
16A, 125 Vac 10A, 250 Vac	1PST	NONE	OFF	ON	B1600	1
	1PDT	NONE	ON	ON	B1601	2
10A, 125 Vac 10A, 250 Vac	1PDT	MOM. ON	OFF	MOM. ON	B1606	9
	1PDT	MOM. ON	OFF	ON	B1607	8
16A, 125 Vac 10A, 250 Vac	2PST	NONE	OFF	ON	B2600	10
	2PST	NONE	OFF	MOM. ON	B2601	11
16A, 125 Vac 10A, 250 Vac	2PDT	NONE	ON	ON	B2602	13
	2PDT	ON	OFF	ON	B2604	14
10A, 125 Vac 10A, 250 Vac	2PDT	MOM. ON	OFF	MOM. ON	B2606	17
	2PDT	MOM. ON	OFF	ON	B2607	16

Code letters and/or numbers.
Add to base circuit number.

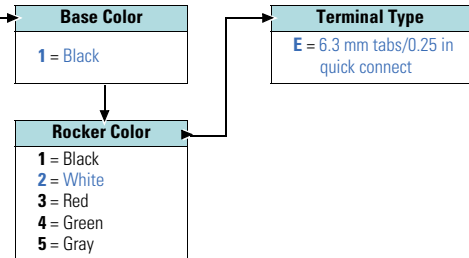

Dimensions

Approximate Dimensions in Inches (mm)

Splashguard

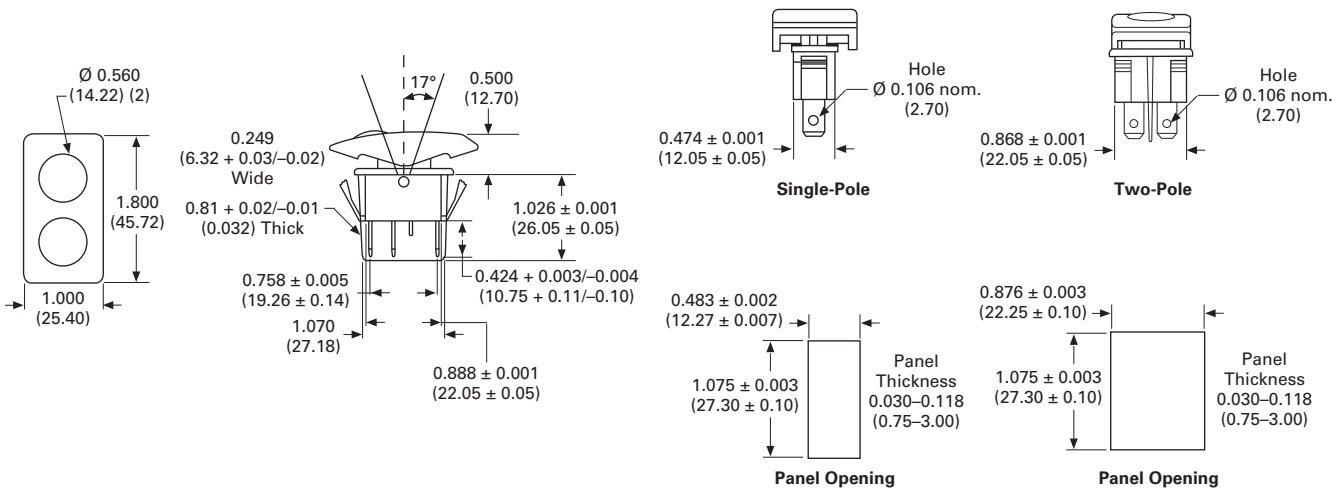

Notes

- ① Splashguard is CUR marked, but does not have ENEC approval.
- ② All circuits also recommended 10A, 28 Vdc.
- ③ See Circuit Diagrams on **Page V11-T2-80**.



High Inrush Rockers

To determine complete catalog number, start with the appropriate base circuit number and add the appropriate code letters and/or numbers.

Catalog Number Selection

How To Order—Non-Illuminated High Inrush Rockers

Example: **1600H** → **M 2 1 E 038**

Rating	Poles and Throw	Circuit with Rocker in ...			Base Circuit Number ^⑤	Circuit Number ^⑤
		UP Position	CENTER Position	DOWN Position ^②		
UL/CSA: ① 22A 125 Vac, 16A 250 Vac, 6A 125 VacL, 10A 14VT, 1 hp 125–250 Vac; ENEC: 16(4)A 250V	1PST	ON ON	NONE NONE	OFF OFF	1600H 1620H ^③	1 2
	2PST	ON	NONE	OFF	2600H	10

Code letters and/or numbers.
Add to base circuit number.

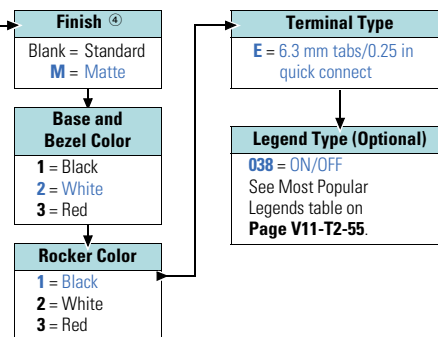

How To Order—Illuminated High Inrush Rockers

Example: **1600H** → **R 2 1 E 038**

Rating	Poles and Throw	Circuit with Rocker in ...			Base Circuit Number ^⑤	Circuit Number ^⑤
		UP Position	CENTER Position	DOWN Position ^②		
UL/CSA: ① 22A 125 Vac, 16A 250 Vac, 6A 125 VacL, 10A 14VT, 1 hp 125–250 Vac; ENEC: 16(4)A 250V	1PST	ON ON	NONE NONE	OFF OFF	1600H 1620HX ^⑥	18 19
	2PST	ON	NONE	OFF	2600H	28
—	—	Indicator	Indicator	—	1609	32

Code letters and/or numbers.
Add to base circuit number.

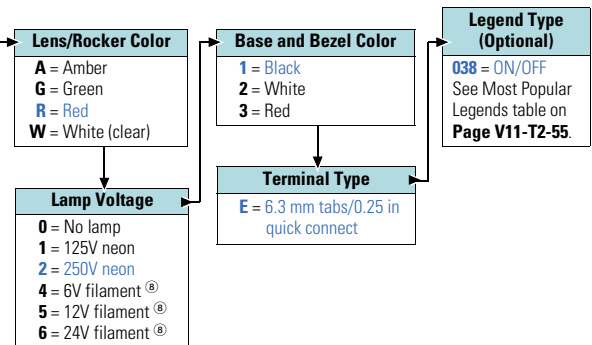

Notes

- ① UL, CSA: 1 hp at 125V or 250 Vac; 6A, 125 Vac (L) rating; 10A, 14 Vdc. Marked on request only.
- ② 1600H Type—Rocker depressed toward terminal #2.
2600H Type—Rocker depressed toward terminals #13 and #26.
- ③ 1620H switch is supplied in 2600H base.
- ④ No code required.
- ⑤ See Circuit Diagrams on Page V11-T2-80.
- ⑥ 1620H switch is supplied in 2600H type base. (Must have “X” code.)
- ⑦ 1600H Type—Rocker depressed toward terminal #3.
1620H Type—Rocker depressed toward terminals #13 and #26.
2600H Type—Rocker depressed toward terminals #13 and #26.
- ⑧ 6V, 12V, 24V filament lamps are not UL, CSA, or ENEC.

Technical Data and Specifications

1600/2600—Midsize AC Rated

2

Description	Specification
Ratings	See selection tables on Pages V11-T2-50 to V11-T2-53.
Circuits	
Standard	1PST, 1PDT, 2PST, 2PDT maintained and momentary
High inrush option	1PST, 2PST maintained
Contact mechanism	
Standard	Slow-make/slow-break butt contact
High inrush option	Slow-make/slow-break butt contact with mechanical break
Make—High inrush option	100A, 250 Vac for 10 ms for 10,000 cycles min.
Break—High inrush option	16A, 250 Vac for 10,000 cycles min.
Contact material	Silver inlay over copper
Contact resistance	10M ohms max. at 1A, 4 Vdc
Mechanical life	50,000 cycles minimum

Description	Specification
Insulation resistance	100M ohms minimum
Dielectric withstand	1000V rms minimum
Terminal types	
Standard	6.3 mm tabs/0.250 in quick connect
Optional	Solder lug
Termination material	
Common (center)	Copper fine silver-plated
End	Copper
Lamp	Brass
Mounting	See dimensions below
Operating temperature range	32° to 185°F (0° to 85°C)

Dimensions

Approximate Dimensions in Inches (mm)

1600/1600H Type Base

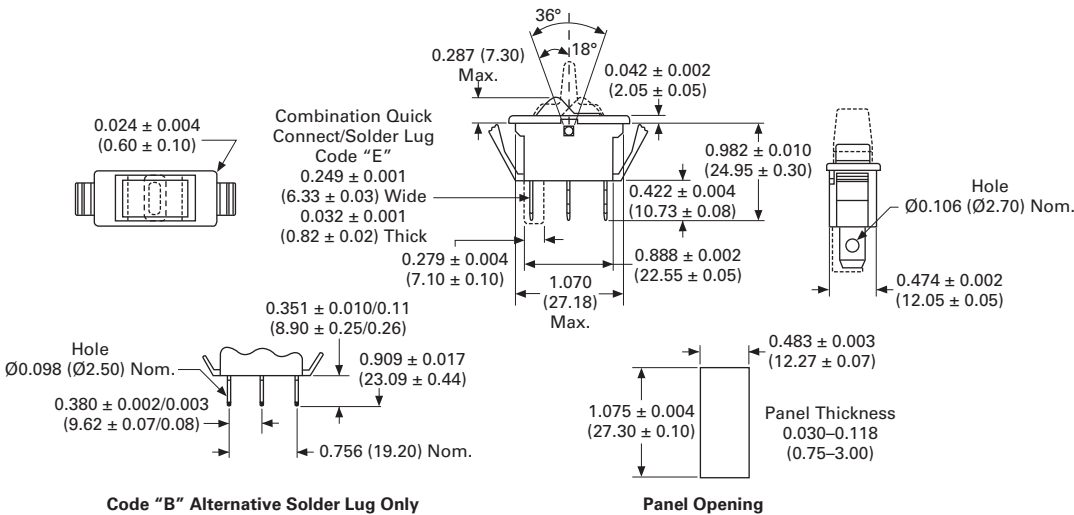

2600/2600H Type Base

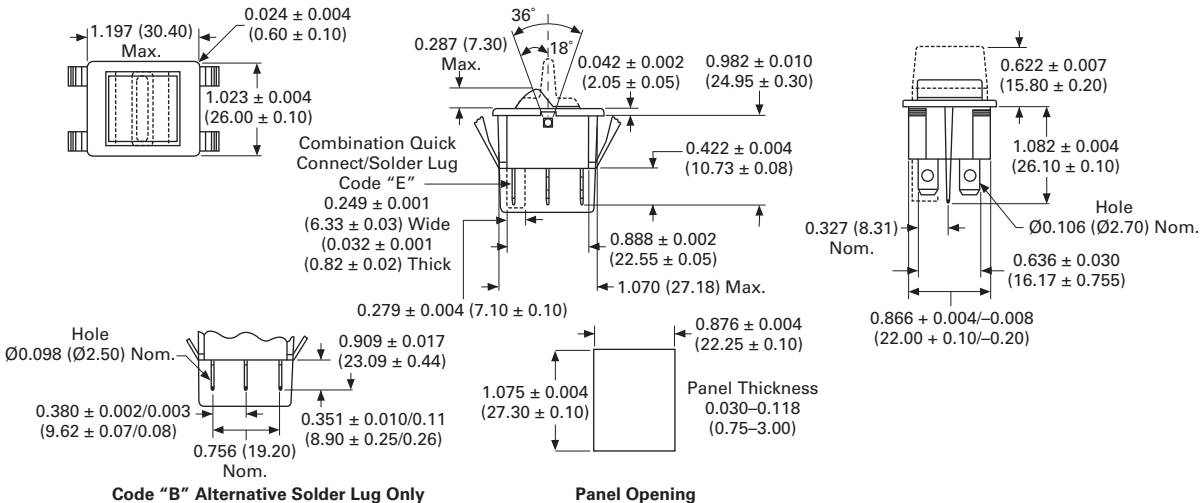

Accessories

Panel Cutout Fillers

If panel cutout fillers are required in anticipation of future rocker or paddle switch installation, order Catalog Number 1609DUM.

Specify color of base and filler portion by using the standard two-digit color code (base and lever) for non-illuminated switches.

Example: 1609DUM11

Legends

How To Order—Legends

To order a rocker with a legend marking, add the three-character code to the end of the catalog number. Example: 1500-21E becomes 1500-21E038.

Legends are for 1500/2500 and 1600/2600 only.

Most Popular Legends ^①

Legend	Code	Legend	Code	Legend	Code	Legend	Code
	014		653		714		735
	023		656		725		746
	038		657		730		752
	039		671		734		760
	630						

Note

^① For additional legend options, contact your local Eaton Sales Representative.

Rockette Series

2



Product Description

These rocker switches offer the widest selection of features available, providing the design flexibility needed to fill the requirements of a variety of applications. They are available in two versions: standard and sealed.

The Sealed Rockette features a silicone rubber seal that protects contacts and mechanisms. All switches resist contaminants such as sand, dust and moisture with both a base-to-frame seal and an actuator seal. Non-illuminated and illuminated versions are available. For Sealed Rockette selection, see table on **Page V11-T2-58**.

Features and Benefits

- Voltages
 - 110 Vac neon
 - 14 Vdc and 28 Vdc

On the illuminated version, the lamp is wired to operate in conjunction with the switch on single-throw circuit; on double-throw circuits, the lamp is independent of the switch

- Mounting
 - Flush (two screws), sub-panel and snap-in mounting
- Snap-in Mounting
 - Convenient front panel or sub-panel snap-in mounting

Available in single- and two-pole non-illuminated or in single-pole illuminated Rockette switches. Contact your local Eaton Sales Representative for three- and four-pole circuits

Unless otherwise noted, all switches with snap-in mounting are UL Recognized and CSA Certified

Contents

<i>Description</i>	<i>Page</i>
Rockette—General Purpose AC Rated	
Standard Rockette Switches	V11-T2-57
Sealed Rockette Switches	V11-T2-58
8058 Series Sealed Rockette Switches	V11-T2-59
Technical Data and Specifications	V11-T2-60
Dimensions	V11-T2-60

Options

Standard and Sealed

- Additional colors of rockers and bezels are available
- Hot stamped or pad printed legends on rocker and bezel
- Paddle actuators
- Single rocker operator on two- and three-pole circuits
- Dry circuits capabilities
- Special ratings
- Reversing jumpers
- Dead back cover (two-pole base) with wire leads
- Special circuits
- Printed circuit terminals and other terminal types
- Metal snap-in bezels
- Foam dust seal

Sealed Only

- Special voltage bulbs
- Industry standard connector available
- Two-pole illuminated circuit

Standards and Certifications

- UL Recognized
- CSA Certified
- RoHS Compliant ^①



Note

^① Visit www.eaton.com/vcbu for the most up-to-date list of verified part numbers.



Standard Rockette Switches

To determine complete catalog number, start with the appropriate base circuit number and add the appropriate code letters and/or numbers.

Catalog Number Selection

How To Order—Standard Rockette Switches

Example: **8132K21** → **E 6 T 50**

Rating	Poles and Throw	Circuit with Rocker in ...			Base Circuit Number ②	Circuit Number ④
		UP Position	CENTER Position	DOWN Position		
6A, 125 Vac 3A, 250 Vac	2PST	ON	NONE	OFF	8132K21 ③	C
	2PDT	ON MOM. ON MOM. ON	OFF NONE OFF	ON MOM. ON ON	8132K20 ③ 8132K22 ③ 8138K20 8138K30	D
15A, 125 Vac 10A, 250 Vac 3/4 hp, 250 Vac	2PST	ON MOM. ON	NONE NONE	OFF OFF	8142K21 8147K21	C
	2PDT	ON MOM. ON MOM. ON	OFF NONE OFF	ON ON MOM. ON ON	8142K20 8142K22 8148K20 8148K30	D
1000W, 125 Vac 10A, 250 Vac	2PST	ON	NONE	OFF	8150K21	C
20A, 250 Vac	2PST	ON	NONE	OFF	8155K21	C
	2PDT	ON ON	OFF NONE	ON ON	8155K20 8155K22	D
6A, 125 Vac 3A, 250 Vac	4PDT	ON	OFF	ON	8130K20 ③	F
	4PST	ON	NONE	OFF	8140K21	E
15A, 125 Vac 10A, 250 Vac ① 3/4 hp, 250 Vac	4PST	ON	OFF	ON	8140K20	F
	4PDT	ON	NONE	ON	8140K22	F

Code letters and/or numbers.
Add to base circuit number.

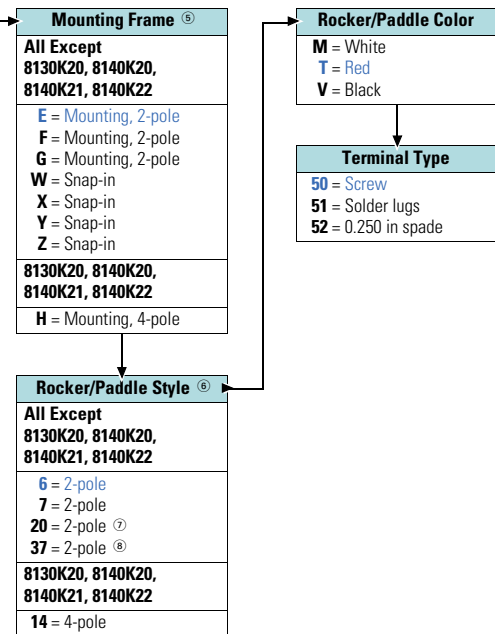

Notes

- ① These switches also have marked rating of 7A at 277 Vac and 3/4 hp at 277 Vac.
- ② Add code letters and numbers for mounting frame, rocker style and color and terminal construction.
- ③ Also rated 2A, 277 Vac; 2.5A, L125 Vac.
- ④ See Circuit Diagrams on **Page V11-T2-80**.
- ⑤ See Frame Styles on **Page V11-T2-61**.
- ⑥ See Rocker Styles on **Page V11-T2-63**.
- ⑦ Cannot be used with snap-in mounting bezel.
- ⑧ Recommended for use with snap-in mounting.



Sealed Rockette Switches

To determine complete catalog number, start with the appropriate base circuit number and add the appropriate code letters and/or numbers.

Catalog Number Selection

How To Order—Sealed Rockette Switches, Non-Illuminated

Example: **8055K23** → **E 2 V**

Rating	Poles and Throw	Circuit with Rocker in ...			Base Circuit Number			Circuit Number ①
		UP Position	CENTER Position	DOWN Position	Terminal Type			
					0.250 in Spade	Solder Lugs	Screw	
15A, 125 Vac 10A, 250 Vac 3/4 hp, 250 Vac	1PST	ON	NONE	OFF	8055K23	8055K24	8055K25	A
		ON	OFF	ON	8055K20	8055K21	8055K22	B
	1PDT	ON	NONE	ON	8055K26	8055K27	8055K28	
	MOM. ON	OFF	MOM. ON	8055K29	8055K30	8055K31	D	
15A, 125 Vac 10A, 250 Vac 3/4 hp, 250 Vac	2PST	ON	NONE	OFF	8055K43	8055K44	8055K45	A
		ON	OFF	ON	8055K40	8055K41	8055K42	B
	2PDT	ON	NONE	ON	8055K46	8055K47	8055K48	
	MOM. ON	OFF	MOM. ON	8055K49	8055K50	8055K51	D	
					8055K52	8055K53	8055K54	

Code letters and/or numbers. Add to base circuit number.

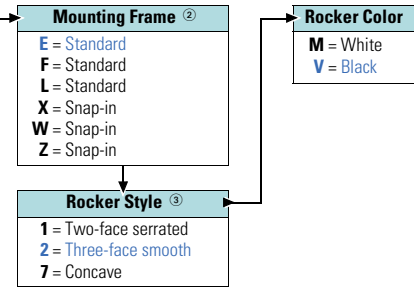

How To Order—Sealed Rockette Switches, Illuminated

Example: **8057K23** → **E 1 5 V 1**

Rating	Poles and Throw	Circuit with Rocker in ...			Base Circuit Number			Circuit Number ①
		UP Position	CENTER Position	DOWN Position	Terminal Type			
					0.250 in Spade	Solder Lugs	Screw	
15A, 125 Vac 10A, 250 Vac	1PST	ON	NONE	OFF	8057K23	8057K24	8057K25	G
	1PDT	MOM. ON	OFF	ON	8057K29	8057K30	8057K31	H

Code letters and/or numbers. Add to base circuit number.

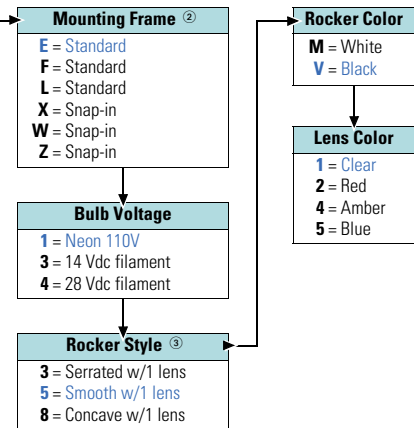

Notes

- ① See Circuit Diagrams on **Page V11-T2-80**.
- ② See Frame Styles on **Page V11-T2-61**.
- ③ See Rocker Styles on **Page V11-T2-63**.



8058 Series Sealed Rockette Switches

To determine complete catalog number, start with the appropriate base circuit number and add the appropriate code letters and/or numbers.

Catalog Number Selection

How To Order—Sealed Rockette Switches, Non-Illuminated

Example: **8058K28** → **Z 7 V**

Rating	Poles and Throw	Circuit with Rocker in ...			Base Circuit Number			Circuit Number ②
		UP Position	CENTER Position	DOWN Position	Terminal Type			
					0.250 in Spade	Solder Lugs	Screw ①	
30A, 125 Vac 25A, 250 Vac 3/4 hp, 125 Vac 2 hp, 250 Vac	1PST	ON	NONE	OFF	N/A	N/A	8058K10	A
	1PDT	ON	OFF	ON	N/A	N/A	8058K22	B
	1PDT	ON	NONE	ON	N/A	N/A	8058K28	B
	1PDT	MOM ON	OFF	ON	N/A	N/A	8058K31	B
	1PDT	MOM ON	OFF	MOM ON	N/A	N/A	8058K34	B

Code letters and/or numbers.
Add to base circuit number.

Mounting Frame ③

E = Standard ears up with two tapped holes
F = Standard flat with two holes
X = Metal snap-in
Z = Standard plastic snap-in
W = Contour plastic snap-in
L = Standard ears up with two holes

Rocker Color

M = White
T = Red
V = Black

Rocker Style ④

1 = Two-face serrated
2 = Three-face smooth
7 = Concave

8058K22E7V



8058K10X7T



8058K28Z7V



Notes

- ① Supplied with terminal screws, (Cat. No. 11-8616), unassembled.
- ② See Circuit Diagrams on **Page V11-T2-80**.
- ③ See Frame Styles on **Page V11-T2-61**.
- ④ See Rocker Styles on **Page V11-T2-63**.

Technical Data and Specifications

Rockette—General Purpose AC Rated

2

Description	Specification
Ratings and circuits	See selection tables on Pages V11-T2-57 to V11-T2-59 . Switch ratings at 125 Vac also apply to 28 Vdc.
Contact mechanism	Slow-make/slow-break contact mechanism. Butt action contact mechanism designed specifically for use on AC and low voltage DC applications
Contact material 3–6A rated	Movable—Silver-plated copper Stationary—Silver-plated copper
10–15A rated	Movable—Silver-plated copper with fine or coin silver contact face button Stationary—Copper with fine or coin silver contact face button
20A rated	Movable—Silver-plated copper with cad-oxide contact face button Stationary—Copper with cad-oxide contact face button

Description	Specification
1000W rated	Movable—Checon SK015B contact material welded to contactor Stationary—Copper with cad-oxide contact face button
Terminal types	Screw terminals—Brass designed to accept #6-32 x 3/16 binding head screws (Cat. No. 811-2), furnished unassembled Solder lug—0.250 in (6.35 mm) spade
Termination material	Screw and spade—Brass Solder—Tintillate-plated brass
Lamp voltages	110 Vac neon 14 Vdc and 28 Vdc
Mounting	Flush (two screws), sub-panel and snap-in mounting

Dimensions

Base Standard Rockette Switch Dimensions

Approximate Dimensions in Inches (mm)

Terminals

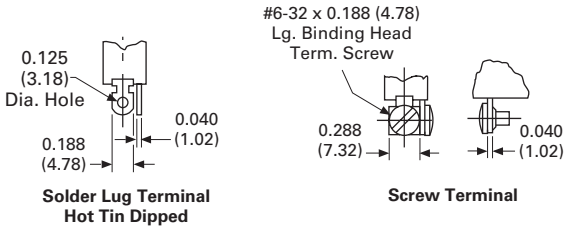

Snap-In Mounting Dimensions

Approximate Dimensions in Inches (mm)

Type W

Contoured Snap-In Bezel, Two-Pole Base

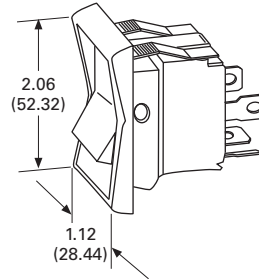

Type X

Snap-In Bezel, Single-, Two- and Four-Pole Bases

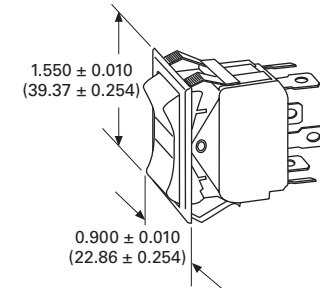

Type Y

Sub-Panel Snap-In Mounting Bezel, Single- and Two-Pole Bases

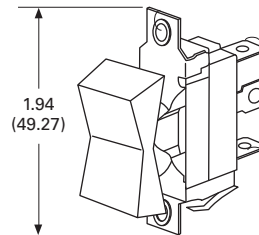

Type Z

Snap-In Mounting Bezel, Two-Pole Base Only

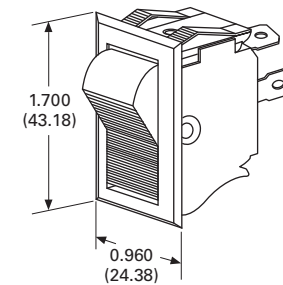

Panel Opening

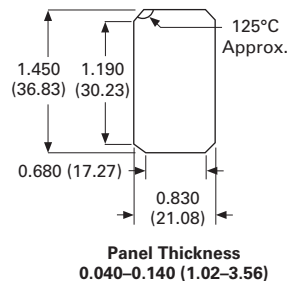

Frame Types and Rocker/Paddle Styles for Standing Switches—Non-Illuminated Dimensions

Approximate Dimensions in Inches (mm)

Two-Pole Mounting Frame Types

Type E

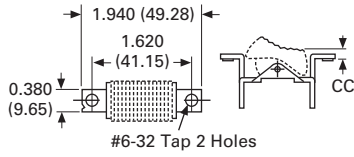

Type F

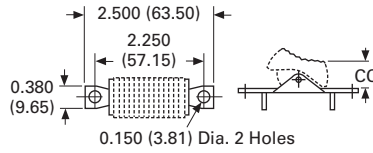

Style 37 with Type X

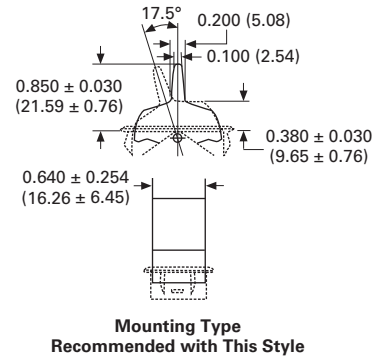

Type G

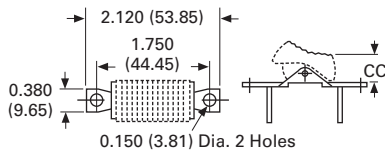

Two-Pole Rocker Styles

Style 6

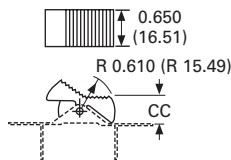

Style 7

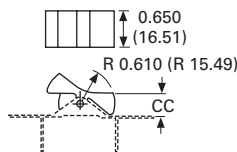

Style 20

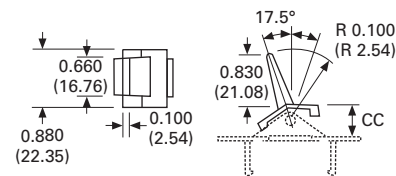

Four-Pole Mounting Frame Type

Type H

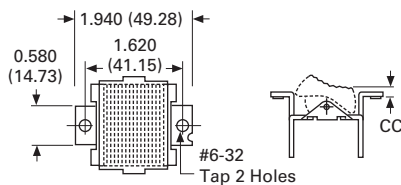

Four-Pole Rocker Styles

Style 14

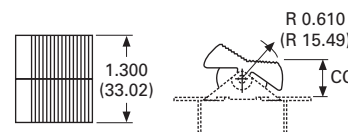

Reference Dimension "CC" — Top of Frame to Bottom of Terminal

Dimension in Inches (mm)				
Mounting Frame Type				
Two-Pole				
Rocker Style	Type E	Type F	Type G	Recommended Panel Opening
6	0.08 (2.03)	0.42 (10.67)	0.42 (10.67)	0.69 x 1.25 (17.53 x 31.75)
7	0.08 (2.03)	0.42 (10.67)	0.42 (10.67)	0.69 x 1.25 (17.53 x 31.75)
20	N/A	0.42 (10.67)	0.42 (10.67)	N/A
37	N/A	N/A	N/A	N/A

Dimension in Inches (mm)		
Mounting Frame Type		
Four-Pole		
Rocker Style	Type H	Recommended Panel Opening
14	0.08 (2.03)	1.34 x 1.25 (34.04 x 31.75)

Base Sealed Rockette Switch Dimensions

Approximate Dimensions in Inches (mm)

2 Sealed Two-Pole—Mounting Frame Type E—Rocker Style 1

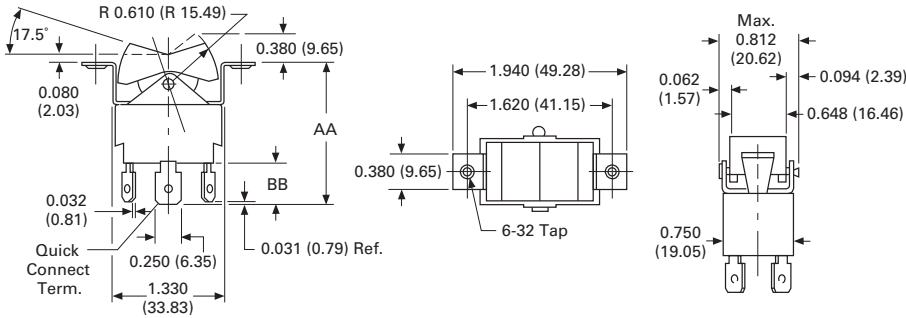

Terminals

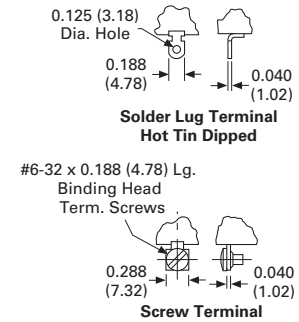

Sealed Two-Pole—Mounting Frame Type F—Rocker Style 1

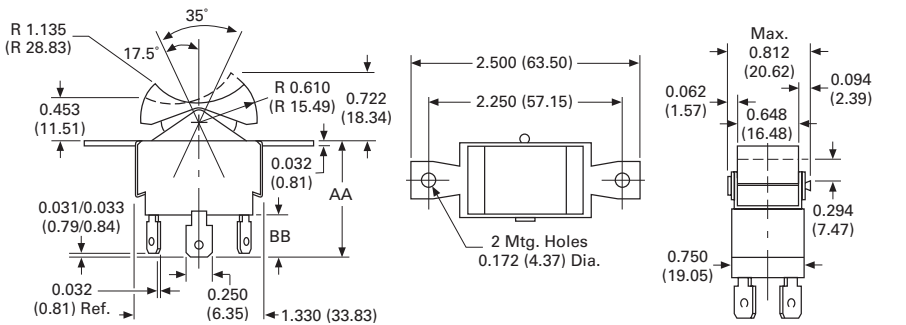

Panel Opening

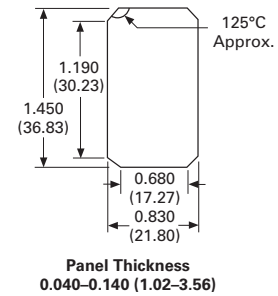

Snap-in Mounting Frame Dimensions

Approximate Dimensions in Inches (mm)

Sealed Two-Pole Switch—Mounting Frame Type W—Rocker Style 7

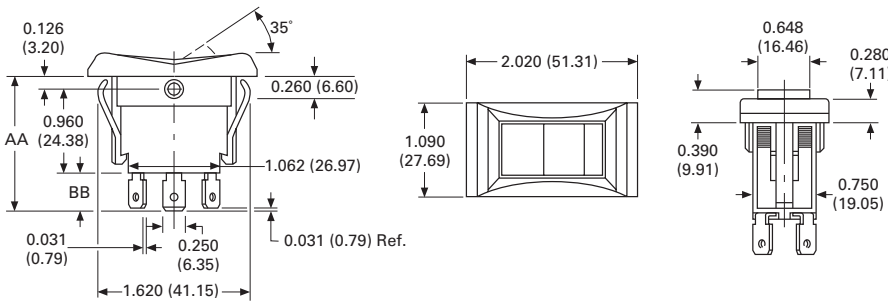

Terminals

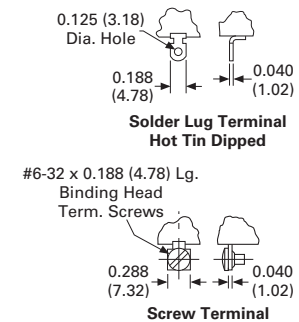

Type X

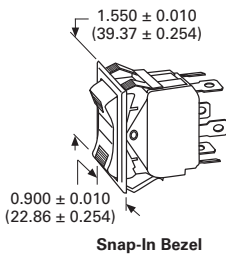

Type Z

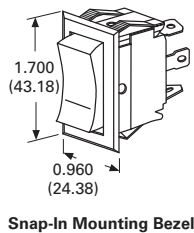

Reference Dimensions "AA" and "BB" in Inches (mm) ①

Terminal Type	Dimension "AA" (Two-Pole)						Dimension "BB"
	E Frame	F Frame	L Frame	W Frame	X Frame	Z Frame	All Frames
Screw	1.39 (35.33)	1.05 (26.62)	1.39 (35.33)	1.37 (34.82)	1.39 (35.34)	1.37 (34.82)	0.30 (7.62)
Solder lug	1.36 (34.57)	1.02 (25.86)	1.36 (34.57)	1.34 (34.06)	1.36 (34.51)	1.34 (34.06)	0.27 (6.86)
0.250 in spade	1.53 (38.89)	1.19 (30.18)	1.53 (38.89)	1.51 (38.38)	1.53 (38.89)	1.51 (38.38)	0.44 (11.18)
8058 Screw ②	1.509 (38.33)	1.145 (29.08)	1.509 (38.33)	1.808 (45.92)	1.627 (41.33)	1.528 (38.81)	0.460 (11.68)

Notes

- ① Dimension "AA"—Top of frame to bottom of terminal; "BB"—from bottom of base to bottom of terminal.
- ② #8-32 x 1/4 Phillips screw.

Dimensions for Frame Type and Rocker Styles—Sealed Switches

Approximate Dimensions in Inches (mm)

Non-Illuminated

Single- and Two-Pole Mounting Frame Types

Type E

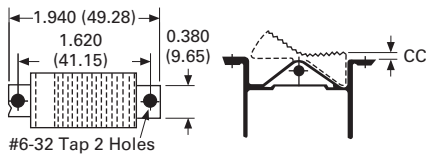

Type F

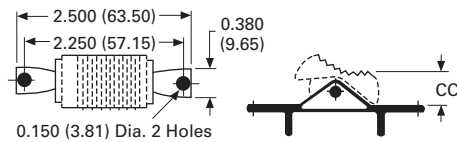

Type L

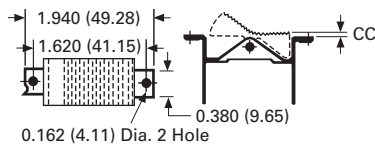

Single- and Two-Pole Rocker Styles

Style 1

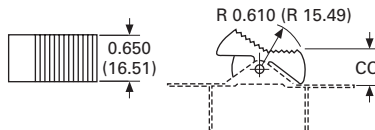

Style 2

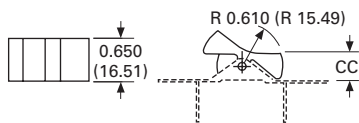

Style 7

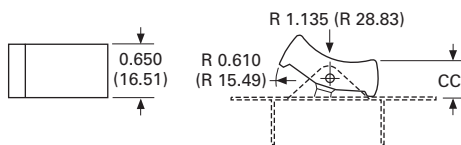

Reference Dimension "CC" — Top of Frame to Rocker Face

Rocker Style	Dimension in Inches (mm)			Recommended Panel Opening
	Mounting Frame Type			
	Single- and Two-Pole (Non-Illuminated)			
	E Frame	F Frame	L Frame	
1	0.08 (2.03)	0.42 (10.67)	0.08 (2.03)	0.69 x 1.25 (17.53 x 31.75)
2	0.08 (2.03)	0.42 (10.67)	0.08 (2.03)	0.69 x 1.25 (17.53 x 31.75)
7	0.11 (2.79)	0.45 (11.43)	0.11 (2.79)	0.69 x 1.25 (17.53 x 31.75)

Illuminated

Single-Pole Mounting Frame Types

Type E

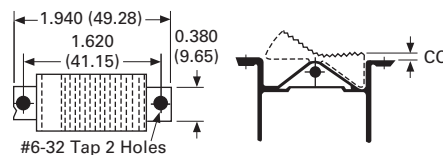

Type F

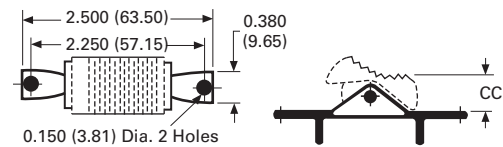

Type L

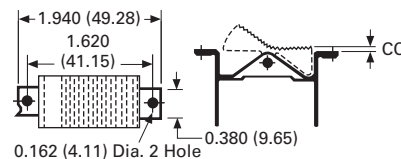

Single-Pole Rocker Styles

Style 3

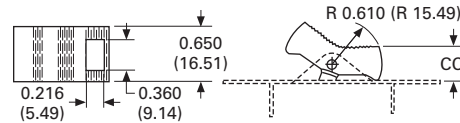

Style 5

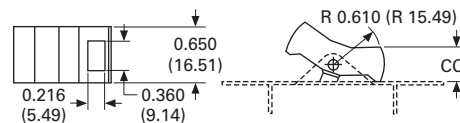

Style 8

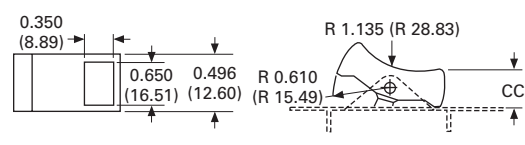

Rocker Style	Dimension in Inches (mm)			Recommended Panel Opening
	Mounting Frame Type			
	Single- and Two-Pole (Illuminated)			
	E Frame	F Frame	L Frame	
3	0.08 (2.03)	0.42 (10.67)	0.08 (2.03)	0.69 x 1.25 (17.53 x 31.75)
5	0.08 (2.03)	0.42 (10.67)	0.08 (2.03)	0.69 x 1.25 (17.53 x 31.75)
8	0.11 (2.79)	0.45 (11.43)	0.11 (2.79)	0.69 x 1.25 (17.53 x 31.75)

8006/8007 Series

2



Product Description

Field-proven in America's roughest off-road applications, the standard size EURO SR is one tough and reliable rocker switch. Available with the complete range of rugged single- and two-pole, illuminated or non-illuminated circuits.

The EURO SR Series offers snap-in mounting and can be provided with a durable silicone seal that resists dust and moisture.

All EURO SR switches are molded in an aesthetically pleasing matte finish and operate with a crisp tactile feel, allowing for easy actuation.

The EURO SR will accept loads up to 15A. Terminal numbers are stamped on base for easy identification.

Features and Benefits

- **Contact Mechanism**
Slow-make/slow-break contact mechanism. Butt action contact mechanism designed specifically for use on AC and low voltage DC applications.
- **Rocker Material**
Thermoplastic rocker actuators. Different colors are available. Rocker and bezel are a high-grade nylon supplied with matte finish.
- **Lamps**
Five lamp voltages—14 Vdc, 18 Vdc, 28 Vdc, 125 Vac neon and 250 Vac neon—are offered as standard. For additional lamp voltages, please contact your local Eaton Sales Representative.
- **Mounting Means**
Snap-in mounting with plastic bezel.
- **Seal**
Available in sealed and non-sealed versions. Sealed devices are furnished with silicone rubber seal, providing moisture and dust resistance with an IP67 rating.

Contents

Description	Page
8006/8007—EURO SR	
Catalog Number Selection	V11-T2-65
Technical Data and Specifications	V11-T2-66
Dimensions	V11-T2-66

Options

- Additional colors of rockers and bezels are available
- Special circuits
- Special ratings
- Pad-printed legends on rocker and bezel
- Special voltage bulbs
- Dry circuit capabilities
- Foam dust seal
- Reversing jumpers
- Printed circuit terminals and other terminal types
- Wire leads
- Dead back cover
- Palm guard
- Industry standard connector: 28-3426
- EURO SR panel plug: 53-3318

For information on optional features, contact your local Eaton Sales Representative.

Lens Options

- **Lens Part Numbers**
(if ordered separately)
- Green 28-5415
- Amber 28-5415-2
- Red 28-5415-3
- Blue 28-5415-4
- White 28-5415-5

Standards and Certifications

- UL Recognized and recognized component for Canada File E2702
- RoHS Compliant ^①



Note

^① Visit www.eaton.com/vcbu for the most up-to-date list of verified part numbers.



EURO SR Standard Size Euro-Style Rocker Switches

To determine complete catalog number, start with the appropriate base circuit number and add the appropriate code letters and/or numbers.

Catalog Number Selection

How To Order—EURO SR, Non-Illuminated

Example: **8006K23** → **N 1 T 1**

Rating	Poles and Throw	Circuit with Rocker in ...			Terminal Type		
		UP Position	CENTER Position	DOWN Position	0.250 in Spade	Solder Lugs	Screw
10A, 250 Vac 15A, 125 Vac 15A, 28 Vdc	1PST	2-3 2-3 ①	NONE	OFF	8006K23 8006K35	8006K24 8006K36	8006K25 8006K37
		2-3 2-3 ① 2-3 ①	OFF NONE OFF	2-1 2-1 2-1 ①	8006K20 8006K26 8006K29 8006K32	8006K21 8006K27 8006K30 8006K33	8006K22 8006K28 8006K31 8006K34
	2PST	2-3, 5-6 2-3, 5-6 ①	NONE	OFF	8006K43 8006K55	8006K44 8006K56	8006K45 8006K57
		2-3, 5-6 2-3, 5-6 ① 2-3, 5-6 ①	OFF NONE OFF	2-1, 5-4 2-1, 5-4 2-1, 5-4 ①	8006K40 8006K46 8006K49 8006K52	8006K41 8006K47 8006K50 8006K53	8006K42 8006K48 8006K51 8006K54
	2PDT ②	2-3, 5-6	5-6	OFF	8006K58	8006K59	8006K60
		5-6	5-3	5-1	8006K61	8006K62	8006K63

Code letters and/or numbers. Add to base circuit number.

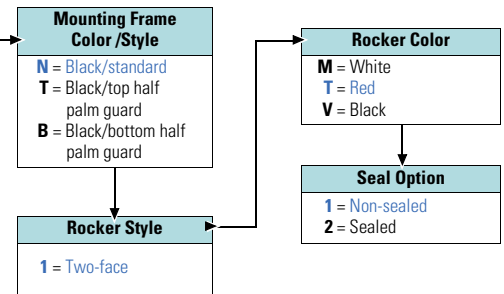

How To Order—EURO SR, Illuminated

Example: **8007K23** → **N 4 1 3 T 2 1**

Rating	Poles and Throw	Circuit with Rocker in ...			Terminal Type		
		UP Position	CENTER Position	DOWN Position	0.250 in Spade	Solder Lugs	Screw
10A, 250 Vac 15A, 125 Vac 15A, 28 Vdc	1PST	OFF NONE	NONE OFF	2-1 2-1 ①	8007K23 8007K35	8007K24 8007K36	8007K25 8007K37
		2-3 2-3 ① 2-3 ①	OFF NONE OFF	2-1 2-1 2-1 ①	8007K20 8007K26 8007K29 8007K32	8007K21 8007K27 8007K30 8007K33	8007K22 8007K28 8007K31 8007K34
	2PST	OFF 2-3, 5-6 ①	NONE OFF	2-1, 5-4 NONE	8007K43 8007K55	8007K44 8007K56	8007K45 8007K57
		2-3, 5-6 2-1, 5-4 2-3, 5-6 ① 2-3, 5-6 ①	OFF NONE OFF	2-1, 5-4 2-3, 5-6 2-1, 5-4 2-1, 5-4 ①	8007K40 8007K46 8007K49 8007K52	8007K41 8007K47 8007K50 8007K53	8007K42 8007K48 8007K51 8007K54

Code letters and/or numbers. Add to base circuit number.

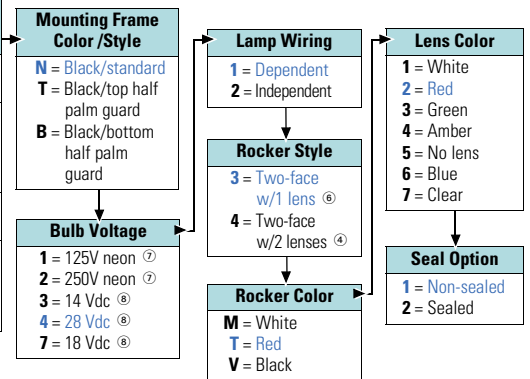

Notes

- ① Momentary contact.
- ② 3A at 250 Vac, 6A at 125 Vac.
- ③ 1/4 hp at 125–250 Vac.
- ④ All double-throw circuits, both 1PDT and 2PDT, provided with two lamps and two lenses (Rocker Style 4). When lamp is wired independent of circuit for 1PDT switches, device is supplied with lamp centered in open-pole of base.
- ⑤ Not standard with lamp wired independent of circuit. All 2PDT switches must be dependent on circuit and use Rocker Style 4.
- ⑥ Not provided standard for double-throw circuits, both 1PDT and 2PDT. Must use Rocker Style 4 for all double-throw switches.
- ⑦ Available on single-pole versions only.
- ⑧ 14 Vdc, 18 Vdc and 28 Vdc bulbs are not UL, CSA when bulb is wired dependent to switch circuit.

Technical Data and Specifications

8006/8007—EURO SR

2

Description	Specification
Ratings	15A at 125 Vac 10A at 250 Vac 3/4 hp at 250 Vac (hp rating does not apply to lighted switches) Switch ratings at 125 Vac also apply to 28 Vdc
Circuits	1PST, 1PDT, 2PST and 2PDT Maintained and momentary action
Mechanical life	Maintained—100,000 operations, minimum Momentary—25,000 operations, minimum
Electrical life	25,000 operations minimum at full load
Terminal types	Standard 0.250 in (6.35 mm) Spade—Brass Screw—Brass (terminal screws provided unassembled) Solder—Tintillate-plated brass
Base material	Thermoset molding material
Rocker material	Thermoplastic rocker actuators
Dielectric	1000V rms, minimum
Seal level	IP67 (with optional seal)
Mounting means	Snap-in mounting with plastic bezel
Operating temperature	−40° to 185°F (−40° to 85°C)

Dimensions

Approximate Dimensions in Inches (mm)

Non-Illuminated

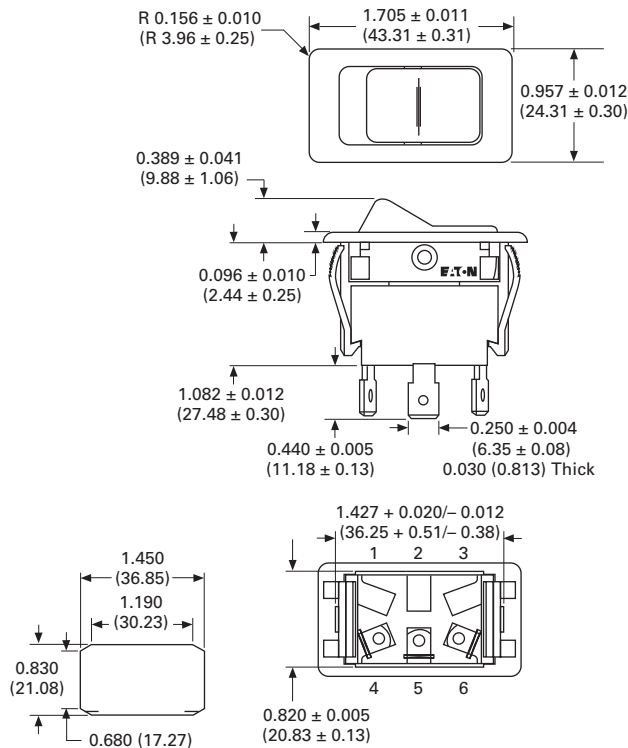

Panel Opening
Reference Only
Thickness:
0.040 to 0.140 (1.02 to 3.56)
Best Results Obtained from:
0.080 to 0.125 (2.03 to 3.18)

Illuminated

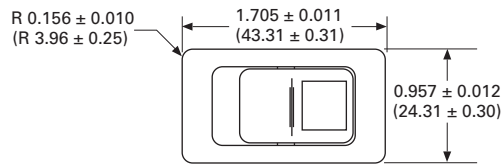

Palm Guard

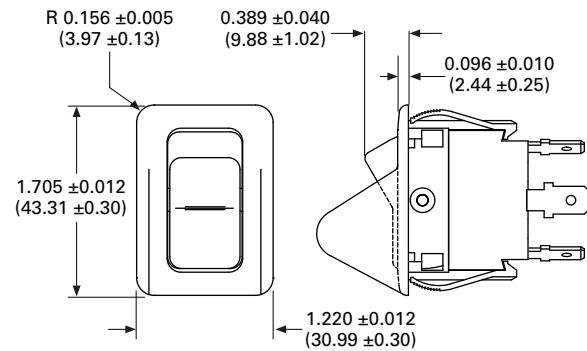

8004/8005—Euro Full Size



Contents

Description

	Page
8004/8005—Euro Full Size	
Catalog Number Selection	V11-T2-68
Technical Data and Specifications	V11-T2-69
Dimensions	V11-T2-69

Product Description

Eaton’s 8004 and 8005 Euro-Look Series features matte finish European styling and snap-in mounting. These durable switches, field-tested in the most demanding truck and marine applications, are available with a variety of standard actuator options. Options include concave, two-face, illuminated, non-illuminated and the recessed feature, which allows placement of your label on the face of our rocker. All switches in this rugged lineup can be fitted with a silicone rubber seal to provide moisture and dust-resistance. Additionally, these switches can be gang-mounted into a single panel opening. Panel blanks are also available.

Features and Benefits

- **Contact Mechanism**
Slow-make/slow-break contact mechanism. Butt action contact mechanism designed specifically for use on AC and low voltage DC applications.
- **Rocker Material**
Custom styled, multi-colored thermoplastic rocker actuators. The rocker and bezel are supplied with a matte finish.
- **Lamps**
Five lamp voltages—14 Vdc, 18 Vdc, 28 Vdc, 125 Vac neon and 250 Vac neon—are offered as standard. For additional lamp voltages, please contact your local Eaton Sales Representative.
- **Mounting Means**
Snap-in mounting with plastic bezel.
- **Seal**
Available in sealed and non-sealed versions. Sealed devices are furnished with a silicone rubber seal providing moisture and dust resistance with an IP54 rating.

Options

- Additional colors of rockers and mounting bezels are available
- Special circuits
- Special ratings
- Gold contacts
- Dry circuit capabilities
- Pad-printed legends on rocker and bezel
- Special lamp voltages
- Foam dust seal
- Reversing jumpers
- Printed circuit terminals and other terminal types
- Dead back cover (two-pole base) with wire leads
- Matching indicators
- Industry standard connector: 28-3426
- Full size Euro-Look gang mounting systems
- Full size Euro-Look panel plugs: 17-19544-2

For information on optional features, contact your local Eaton Sales Representative.

Lens Options

- **Lens Part Numbers** (if ordered separately)
 - 8005 Two-Face*
 - Green 28-3425
 - Amber 28-3425-2
 - Red 28-3425-3
 - Blue 28-3425-4
 - White 28-3425-5
 - 8005 Concave*
 - Red 28-5148
 - Green 28-5148-2
 - Amber 28-5148-3
 - Blue 28-5148-4
 - Clear 28-5148-5

Standards and Certifications

- UL Recognized and recognized component for Canada File E2702
- RoHS Compliant ①



Note

① Visit www.eaton.com/vcbu for the most up-to-date list of verified part numbers.



Full Size, Euro-Look Rocker Switches

To determine complete catalog number, start with the appropriate base circuit number and add the appropriate code letters and/or numbers.

Catalog Number Selection

How To Order—Full Size Euro, Non-Illuminated

Example: **8004K23** → **N 1 T 1**

Rating	Poles and Throw	Circuit with Rocker in ...			Terminal Type		
		UP Position	CENTER Position	DOWN Position	0.250 in Spade	Solder Lugs	Screw
10A, 250 Vac 15A, 125 Vac 15A, 28 Vdc	1PST	2-3 2-3 ①	NONE	OFF	8004K23 8004K35	8004K24 8004K36	8004K25 8004K37
		2-3 2-3 ① 2-3 ①	OFF NONE OFF	2-1 2-1 2-1 ①	8004K20 8004K26 8004K29	8004K21 8004K27 8004K30	8004K22 8004K28 8004K31
	2PST	2-3, 5-6 2-3, 5-6 ①	NONE	OFF	8004K43 8004K55	8004K44 8004K56	8004K45 8004K57
		2-3, 5-6 2-3, 5-6 2-3, 5-6 ①	OFF NONE OFF	2-1, 5-4 2-1, 5-4 2-1, 5-4 ①	8004K40 8004K46 8004K49	8004K41 8004K47 8004K50	8004K42 8004K48 8004K51
	2PDT	2-3, 5-6 2-3, 5-6 ①	5-6	OFF	8004K58	8004K59	8004K60
		5-6	5-3	5-1	8004K61	8004K62	8004K63

Code letters and/or numbers. Add to base circuit number.

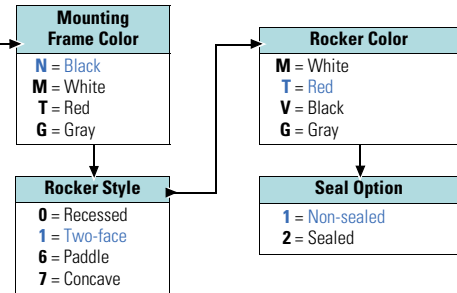

How To Order—Full Size Euro, Illuminated

Example: **8005K23** → **N 4 1 3 T 2 1**

Rating	Poles and Throw	Circuit with Rocker in ...			Terminal Type		
		UP Position	CENTER Position	DOWN Position	0.250 in Spade	Solder Lugs	Screw
10A, 250 Vac 15A, 125 Vac 15A, 28 Vdc	1PST	OFF NONE	NONE OFF	2-1 2-1 ①	8005K23 8005K35	8005K24 8005K36	8005K25 8005K37
		2-3 2-3 2-3 ① 2-3 ①	OFF NONE OFF OFF	2-1 2-1 2-1 2-1 ①	8005K20 8005K26 8005K29 8005K32	8005K21 8005K27 8005K30 8005K33	8005K22 8005K28 8005K31 8005K34
	2PST	OFF 2-3, 5-6 ①	NONE OFF	2-1, 5-4 NONE	8005K43 8005K55	8005K44 8005K56	8005K45 8005K57
		2-3, 5-6 2-1, 5-4 2-3, 5-6 ① 2-3, 5-6 ①	OFF NONE OFF OFF	2-1, 5-4 2-3, 5-6 2-1, 5-4 2-1, 5-4 ①	8005K40 8005K46 8005K49 8005K52	8005K41 8005K47 8005K50 8005K53	8005K42 8005K48 8005K51 8005K54

Code letters and/or numbers. Add to base circuit number.

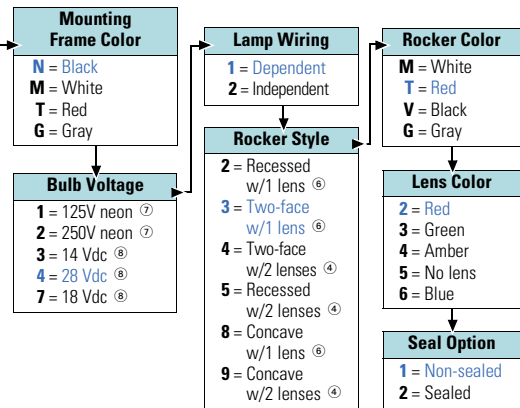

Notes

- ① Momentary contact.
- ② 3A at 250 Vac, 5A at 125 Vac.
- ③ 1/4 hp at 125–250 Vac.
- ④ All double-throw circuits, both 1PDT and 2PDT, provided with two lamps and two lenses (Rocker Style 4). When lamp is wired independent of circuit for 1PDT switches, device is supplied with lamp centered in open-pole of base.
- ⑤ Not standard available with lamp wired independent of circuit. All 2PDT switches must be dependent on circuit and use Rocker Style 4, 5 or 9.
- ⑥ Not provided standard for double-throw circuits, both 1PDT and 2PDT. Must use Rocker Style 4, 5 or 9 for all double-throw switches.
- ⑦ Available on single-pole versions only.
- ⑧ 14 Vdc and 28 Vdc bulbs are not UL, CSA when bulb is wired dependent to switch circuit.

Technical Data and Specifications

8004/8005—Euro Full Size

Description	Specification
Ratings	15A at 125 Vac; 10A at 250 Vac; 3/4 hp at 250 Vac (hp rating does not apply to lighted switches) Switch ratings at 125 Vac also apply to 28 Vdc
Circuits	1PST, 1PDT, 2PST and 2PDT; Maintained and momentary action
Contact material	Movable—Silver-plated copper with fine or coin silver contact face button Stationary—Copper with fine or coin silver contact face button
Mechanical life	Maintained—100,000 operations, minimum Momentary—25,000 operations, minimum
Electrical life	25,000 operations minimum at full load
Terminal types	Standard 0.250 in (6.35 mm) spade—Brass Screw—Brass #6-32 x 3/16 (terminal screws provided unassembled) Solder—Tintillate-plated brass; tintillate spade terminals
Base material	Thermoset molding material
Dielectric	1000V rms, minimum
Seal level	IP54 (with optional seal)
Mounting means	Snap-in mounting with plastic bezel

Dimensions

Approximate Dimensions in Inches (mm)

Non-Illuminated

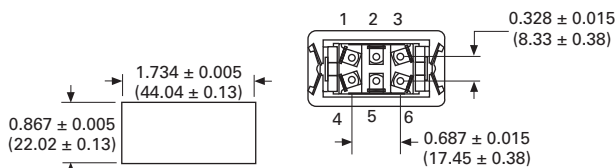
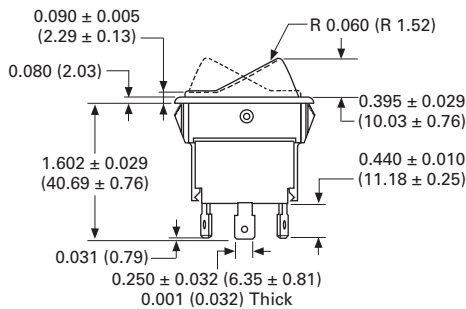
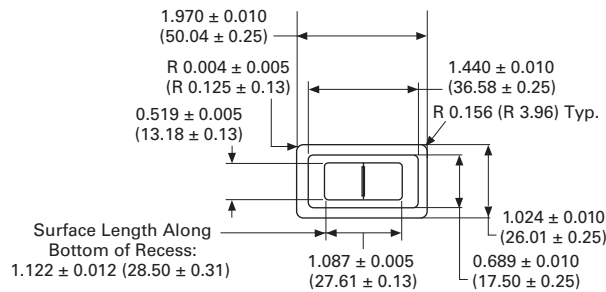

Panel Opening
Reference Only
Thickness:
0.030 to 0.190 (0.76 to 4.83)
Best Results Obtained From:
0.080 to 0.130 (2.03 to 3.30)

Illuminated

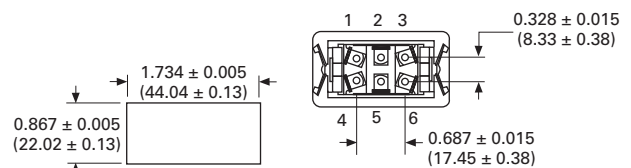
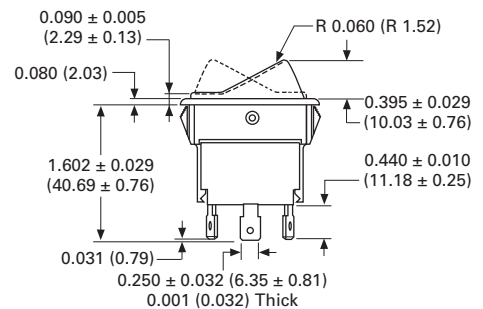
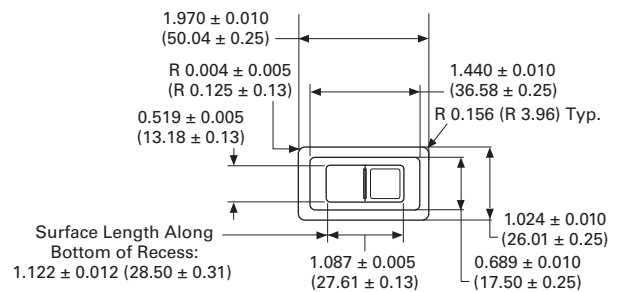

Panel Opening
Reference Only
Thickness:
0.030 to 0.190 (0.76 to 4.83)
Best Results Obtained From:
0.080 to 0.130 (2.03 to 3.30)

X Series Rockers—XR

2



Contents

Description

Page

X Series Rockers	
Catalog Number Selection	V11-T2-71
X Series Symbols Library	V11-T2-72
Technical Data and Specifications	V11-T2-72
Light Diagrams	V11-T2-72
Dimensions	V11-T2-73

Product Description

The Electrical Sector is pleased to offer X Series Rockers for use in outdoor applications to meet almost every market need.

These sleek style rockers are molded in a unique smooth matte finish. The bezel is also unique with a more modern rounded-rectangular design with an oval shaped rocker. X Series Rockers are available in single- and double-pole with various circuit options, LED illumination, and laser etching.

- Frames and actuator colors are black
- Switches provided with 0.025 spade quick connect terminals

Application Description

Market Applications

- Agriculture
- Bus
- Commercial
- Marine
- Specialty Vehicle
- Truck

Features and Benefits

- Seal
Standard IP56 Sealing per IES 60529.
- Illumination
Standard LED voltages offered include 14 Vdc and 125 Vac.
- Material
Frames are nylon and actuators are nylon with glass fiber with both meeting UL flame: 94HB. Terminals are silver plated brass.
- Mounting Means
Easy snap-in mounting with plastic bezel.
- Label
Eaton part number etched on switch for easy inventory management.

Options

- Panel plug: 53-3318
- Industry standard connector: 28-3426
- For information on optional features, contact your local Eaton Sales Representative.

Standards and Certifications

- UL Recognized and recognized component for Canada File E2702
- T85
- RoHS Compliant

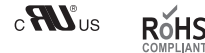

Product Selection Guide

Seal	Actuator	Decorative	Termination	Illumination
Top ✓	Rocker without bezel —	Laser-etch ✓	Spade ✓	Incandescent 6 Vdc —
Bottom —	Rocker with bezel ✓	Pad-print —	Solder —	Incandescent 12 Vdc —
Panel —	Paddle —		Screw —	Incandescent 14 Vdc —
	Snap-in lens —	Poles	Weld lugs —	Incandescent 18 Vdc —
	Locking —	Single ✓		Incandescent 24 Vdc —
	Label —	Double ✓		Incandescent 28 Vdc —
		Four —		Neon 110V —
				Neon 125V —
				Neon 250V —
				14 Vdc LED ✓
				28 Vdc LED —
				125 Vac LED ✓
				277 Vac LED —



X Series Rockers

Catalog Number Selection

Standard rating 16A 125V, 10A 277V, 3/4 hp 277V
Also recommended for use in applications up to 21A 14 Vdc
IP56 per IES 60529

Product Selection

XR Series Rocker



X Series Rockers

Lamp Voltage	Switch Function	Light Circuit ^③	Lens Color T. 1-4	T. 3-6	Switch Markings	Catalog Number
None	SPST OFF-ON	X = None	None	None	Int'1 ON/OFF ^④	XRAXXXNV1CU
	SPST OFF-ON	X = None	None	None	ON/OFF ^④	XRAXXXNV1DB
14 Vdc LED	SPST OFF-ON	E =	None	Amber	None	XR1AEX4NV1XX
	SPST OFF-ON	E =	None	Green	None	XR1AEX3NV1XX
	SPST OFF-ON	E =	None	Red	None	XR1AEX2NV1XX
	SPDT ON-ON	G =	Amber	Amber	None	XR1CG44NV1XX
	SPDT ON-ON	G =	Green	Green	None	XR1CG33NV1XX
	SPDT ON-OFF-ON	G =	Amber	Amber	None	XR1BG44NV1XX
	SPDT ON-OFF-ON	G =	Green	Green	None	XR1BG33NV1XX
	SPDT (ON)-OFF-(ON)	G =	Amber	Amber	None	XR1EG44NV1XX
	SPDT (ON)-OFF-(ON)	G =	Green	Green	None	XR1EG33NV1XX
None	DPST OFF-ON ^②	X = None	None	None	Int'1 ON/OFF ^④	XRXXNV1CU
	DPST OFF-ON ^②	X = None	None	None	ON/OFF ^④	XRXXNV1DB
	DPST OFF-ON	X = None	None	None	None	XRXXNV1XX
	DPST ON-ON	X = None	None	None	None	XRXXNV1XX
125 Vac LED ^①	SPST OFF-ON	E =	None	Amber	None	XR3AEX4NV1XX
	SPST OFF-ON	E =	None	Green	None	XR3AEX3NV1XX
	SPST OFF-ON	E =	None	Red	None	XR3AEX2NV1XX
	SPDT ON-ON	G =	Amber	Amber	None	XR3CG44NV1XX
	SPDT ON-ON	G =	Green	Green	None	XR3CG33NV1XX
	SPDT ON-OFF-ON	G =	Amber	Amber	None	XR3BG44NV1XX
	SPDT ON-OFF-ON	G =	Green	Green	None	XR3BG33NV1XX
	SPDT (ON)-OFF-(ON)	G =	Amber	Amber	None	XR3EG44NV1XX
SPDT (ON)-OFF-(ON)	G =	Green	Green	None	XR3EG33NV1XX	

Notes

- ① Available in AC applications only.
- ② Double-pole not available illuminated; it is available laser etched.
- ③ See Circuit Diagrams on **Page V11-T2-72**.
- ④ See Symbols Library on **Page V11-T2-72**.

X Series Symbols Library

2

Inscription	Catalog Number Suffix	Inscription	Catalog Number Suffix
— ○	CU	ON OFF	DB

Technical Data and Specifications

X Series

Description	Specification
Ratings	16A 125V, 10A 277V, 3/4 hp 277V; recommended 21A 14 Vdc or 10A 28 Vdc
Operating temperature	-4° to 176°F (-20° to 80°C)

Light Diagrams

X Series

Light Circuit Letter	Functions	Light Circuit Letter	Functions	Light Circuit Letter	Functions
X	All	E	SPST	G	SPDT
1 ● ● 4 2 ● ● 5 3 ● ● 6			<p>Jumpers (3-4)</p>		

Dimensions

Approximate Dimensions in Inches (mm)

Mounting Hole

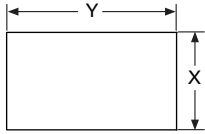

Dimensions

Thickness	0.03–0.12 (0.75–3.0)
X	0.83 +0.01 (21.2 +0.1)
Y	1.46 + 0.01 (37.0 +0.1)

X Series

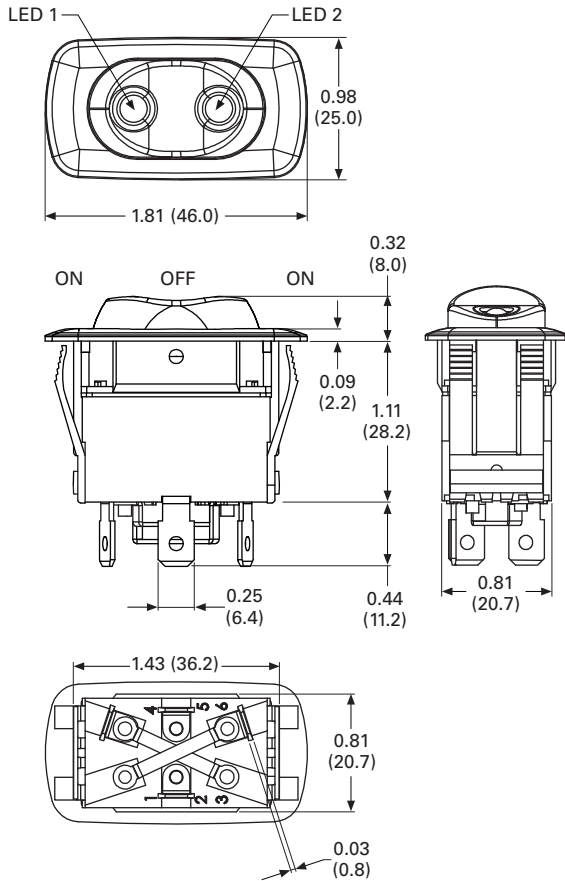

8064/8065 Series

2



Product Description

The ergonomically designed ESPORT Series comes with a large, independent LED-illuminated indicator window that clearly identifies the switch's labeled function—your label or ours. The switch can be ordered with an LED illuminated actuator, as well. All ESPORT switches are molded in a clean matte finish and operate with a definite tactile feel. Actuation of the switch feels crisp. Also, ESPORT switches will accept loads up to 15A. Due to the LED's long life, lamp replacement should not be necessary.

Tested in America's toughest truck applications, the ESPORT switch is reliable and durable and is available with a full range of rugged single- and two-pole circuits. It has an optional polarized lock-on connector. Spade switch terminals are tin-plated for long storage life.

Features and Benefits

- Contact Mechanism

Slow-make/slow-break contact mechanism. Butt action contact mechanism designed specifically for use on AC and low voltage DC applications.

- Rocker Material

Thermoplastic rocker actuators. Different colors are available. The rocker and the bezel are a high-grade nylon and are supplied with an aesthetically pleasing matte finish.

- Lamps

Durable, long-life LED illumination; 14 Vdc is standard. Integral indicator is illuminated by two independent green, yellow or red LEDs while the actuator is lighted using one dependent LED. For additional LED voltages and/or colors, contact your local Eaton Sales Representative.

- Mounting Means

Snap-in mounting with plastic bezel.

Contents

Description

8064/8065—ESPORT

	<i>Page</i>
Catalog Number Selection	V11-T2-75
Technical Data and Specifications	V11-T2-76
Icon/Legend Selection	V11-T2-76
Dimensions	V11-T2-77

Options

- Additional colors of rockers and mounting bezels are available
- Special circuits
- Special ratings
- Dry circuit capabilities
- Pad-printed legends on lens, rocker and bezel
- Special indicator legend labels
- Special LEDs and LED voltages
- Special actuators
- Reversing jumpers
- Solder terminals and other terminal types
- Wire leads
- Polarized lock-on connector: 28-5558
- Full-size Euro-Look panel plugs: 17-19544-2

For information on optional features, contact your local Eaton Sales Representative.

Standards and Certifications

- UL Recognized and recognized component for Canada: File 2702
- RoHS Compliant ^①



Note

^① Visit www.eaton.com/vcbu for the most up-to-date list of verified part numbers.



ESPORT Full-Size Rocker Switches

To determine complete catalog number, start with the appropriate base circuit number and add the appropriate code letters and/or numbers.

Catalog Number Selection

How To Order—ESPORT, Non-Illuminated

Example: **8064K10** → **L R Z 1 W 2**

Rating	Poles and Throw	Circuit with Rocker in ...			Base Circuit Number
		UP Position	CENTER Position	DOWN Position	
15A, 125 Vac 15A, 28 Vdc	1PST	5-6	NONE	OFF	8064K10
		OFF	NONE	5-4	8064K11
	1PDT	2-3	OFF	2-1	8064K14
		2-3	NONE	2-1	8064K12
		2-3 ^①	OFF	2-1	8064K17
		2-3 ^①	OFF	2-1 ^①	8064K16
	2PST	2-3, 5-6	NONE	OFF	8064K20
		OFF	NONE	2-1, 5-4 ^①	8064K21
	2PDT	2-3, 5-6	OFF	2-1, 5-4	8064K24
		2-3, 5-6	NONE	2-1, 5-4	8064K22
		2-3, 5-6 ^①	OFF	2-1, 5-4	8064K27
		2-3, 5-6 ^①	OFF	2-1, 5-4	8064K26

Code letters and/or numbers.
Add to base circuit number.

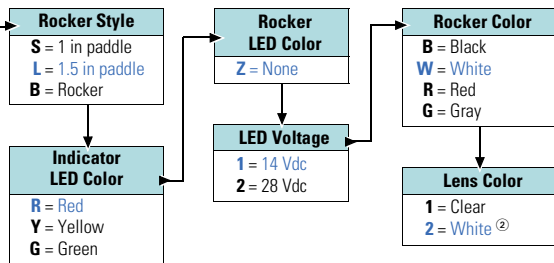

How To Order—ESPORT, Illuminated

Example: **8065K10** → **S R Y 1 W 2**

Rating	Poles and Throw	Circuit with Rocker in ...			Base Circuit Number
		UP Position	CENTER Position	DOWN Position	
15A, 125 Vac 15A, 28 Vdc	1PST	5-6	NONE	OFF	8065K10

Code letters and/or numbers.
Add to base circuit number.

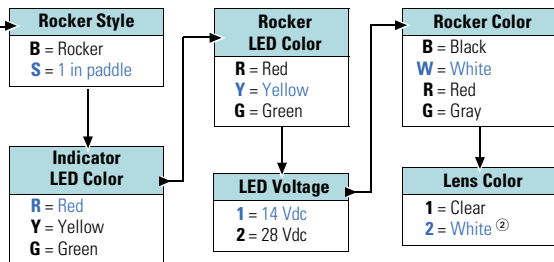

Notes

- ① Momentary contact.
- ② White lenses are furnished unassembled.

Technical Data and Specifications

8064/8065—ESPORT





2

Description	Specification
Ratings	15A at 125 Vac; 10A at 250 Vac; 3/4 hp at 250 Vac Switch ratings at 125 Vac also apply to 28 Vdc
Circuits	1PST, 1PDT, 2PST and 2PDT Maintained and momentary action
Contact material	Movable—Silver-plated copper with silver contact face button Stationary—Copper with silver contact face button
Mechanical life	Maintained—100,000 operations, minimum Momentary—25,000 operations, minimum
Terminal types	Switch—Standard 0.250 in (6.35 mm) spade, tinned-plated brass Integral indicator—0.110 x 0.032 in (2.79 x 0.813 mm) spade, tinned-plated brass
Base material	Thermoset molding material
Dielectric	1000V rms, minimum
Mounting means	Snap-in mounting with plastic bezel

Icon/Legend Selection

- All labels below come with adhesive backing
- Label legends are distinct and easily readable when illuminated from behind
- Additional labels are available upon request. Contact your local Eaton Sales Representative

Icons and Legends

Legend	Style	Ordering Code ^①	Icon	Description	Ordering Code ^①
Dome Light		0055		Windshield Wiper SAE Specification No. J1362-0086 White graphic on a black background	0057
Work Light		0056			
TV/VCR		0065			
Fridge		0066		Windshield Washer SAE Specification No. J1362-0087 White graphic on a black background	0986
Cruise ON/OFF		0067			
Brake Select	Helvetica Narrow	0068			
Brake ON/OFF	0.135 in (3.43 mm) high White translucent letters	0069		Master Lighting Switch SAE Specification No. J1362-5012 White graphic on a black background	0687
Fan Override	Opaque black background	0071			
Cruise Set		0681			
Engine Brake		0682		Fog Lights SAE Specification No. J1362-0633 White graphic on a black background	0684
Left Window		0683			
Power Mirror		0688		Clearance/Position Light SAE Specification No. J1362-0456 White graphics on a black background	0686
Right Window		0689			

Note

- ^① Ordering Code: If a standard label is required, add the Ordering Code to the end of ESPORT Switch part number preceded by a dash. Example: To order 8065K10BYR1B1 with the 0684 Fog Lights label, the part number will be 8065K10BYR1B1-0684.

Dimensions

Approximate Dimensions in Inches (mm)

Non-Illuminated and Illuminated

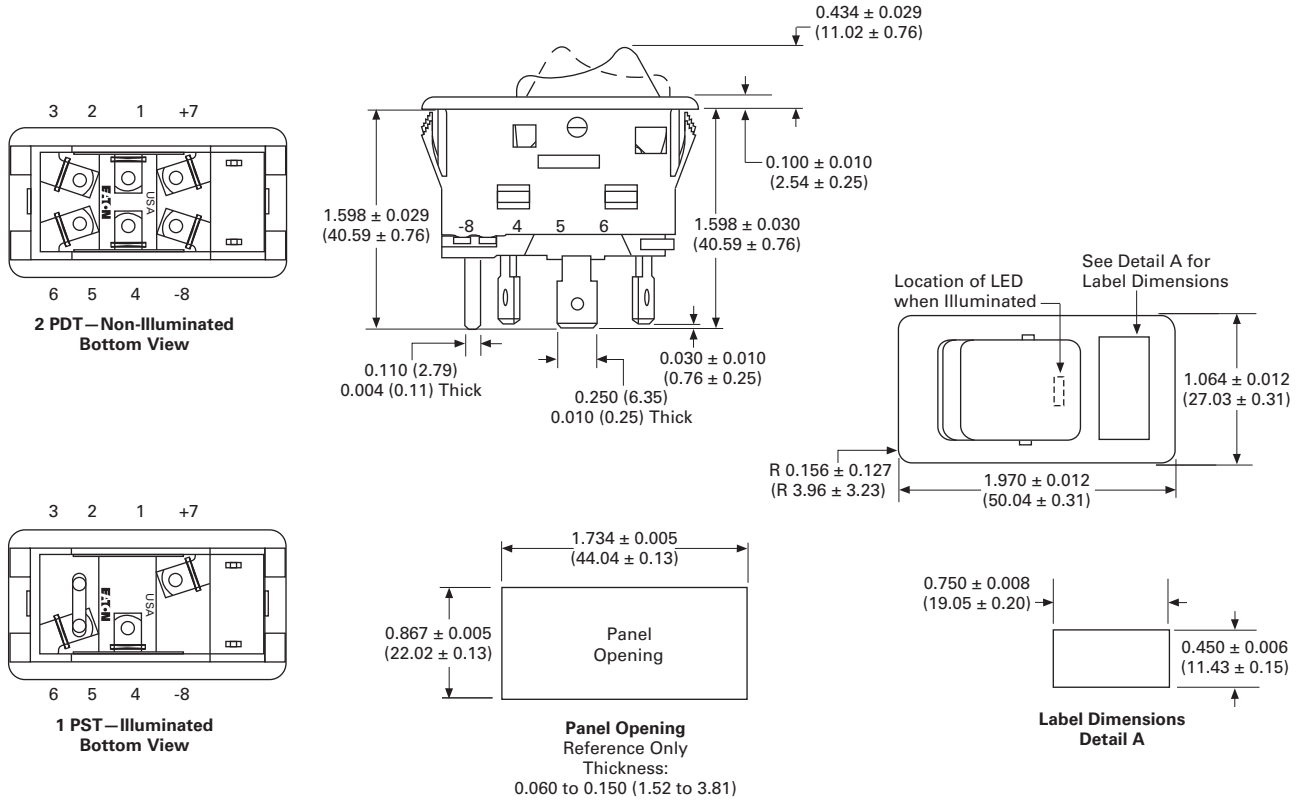

Dimensions for NGR, EURO SR, Full Size Euro-Look and ESPORT Rocker Accessories

Approximate Dimensions in Inches (mm)

2

NGR Connector

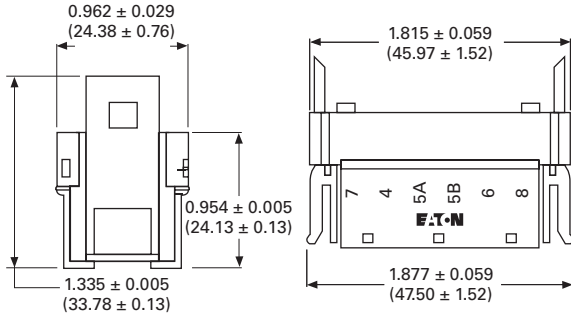

NGR Connector Catalog Number **28-5637-2** accepts Packard 12015870 Metri-Pack terminals or AMP compatible connector **28-5940** accepts AMP terminals 42100-2.

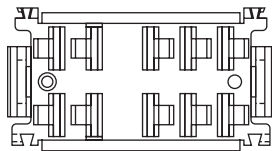

Euro/SR and Full Size Euro-Look Connector

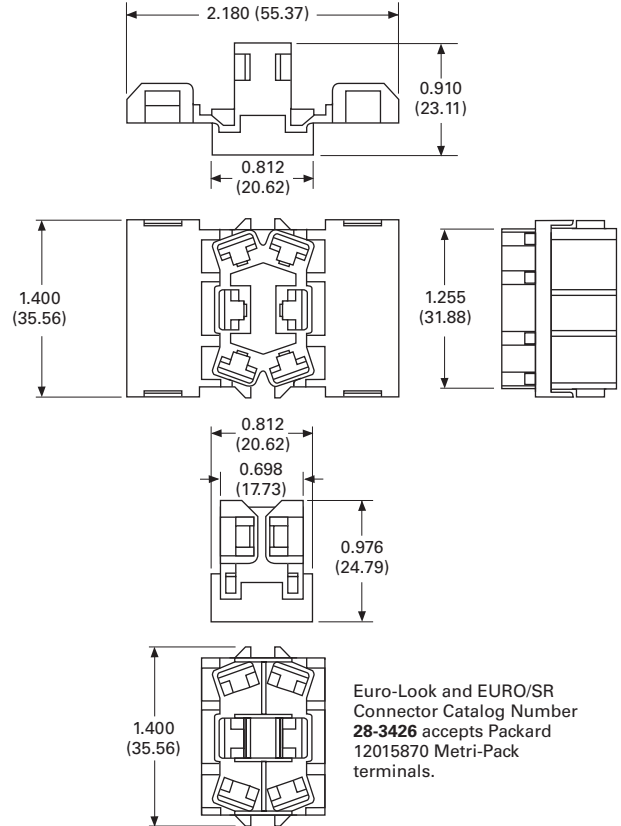

Euro-Look and EURO/SR Connector Catalog Number **28-3426** accepts Packard 12015870 Metri-Pack terminals.

ESPORT Connector

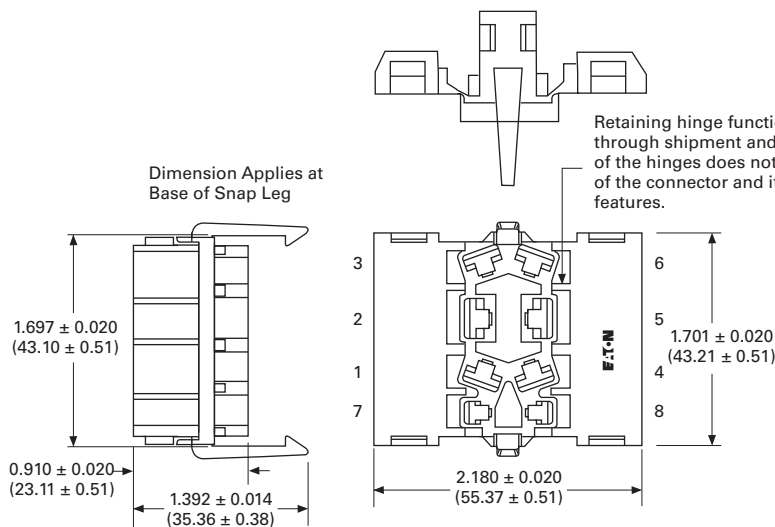

ESPORT Connector Catalog Number **28-5558**
 Locations 1, 2, 3, 4, 5 and 6 accept Packard 12015870 Metri-Pack terminals.
 Locations 7 and 8 accept Packard 12034046 Metri-Pack terminals.

Approximate Dimensions in Inches (mm)

Gang Mounting System

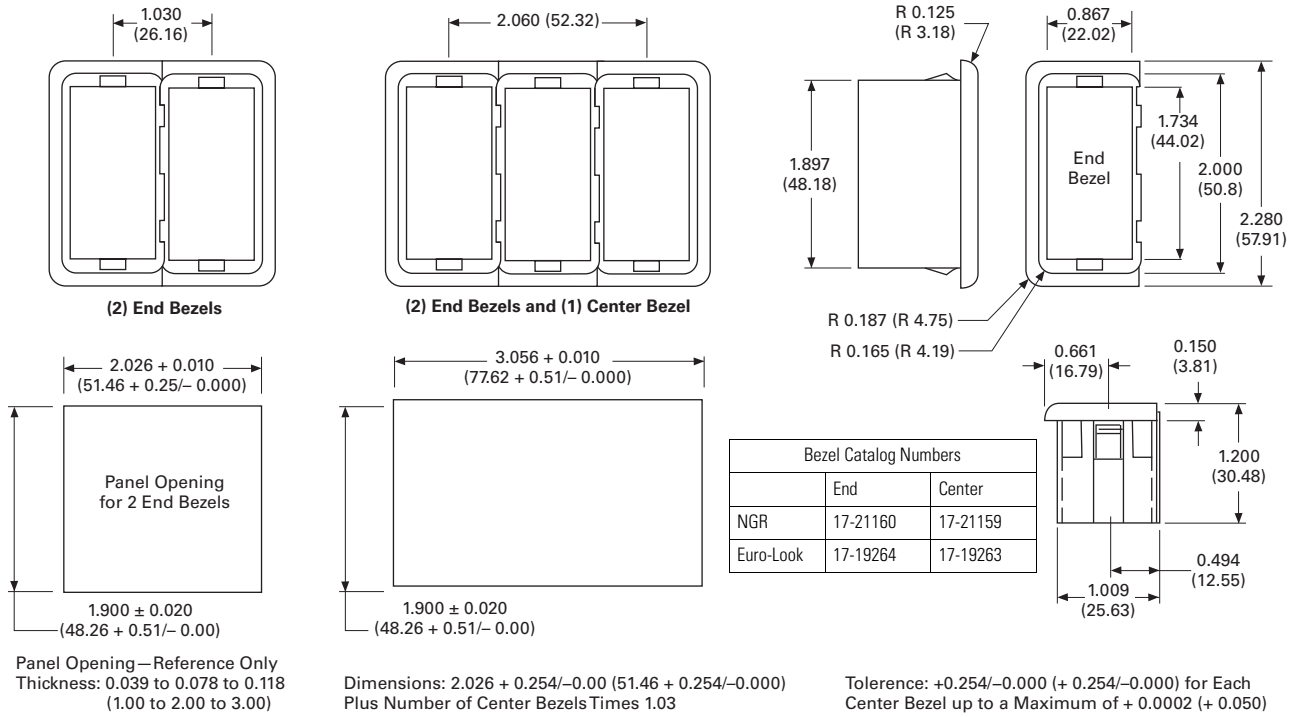

NGR, Euro-Look and ESPORT Panel Plugs

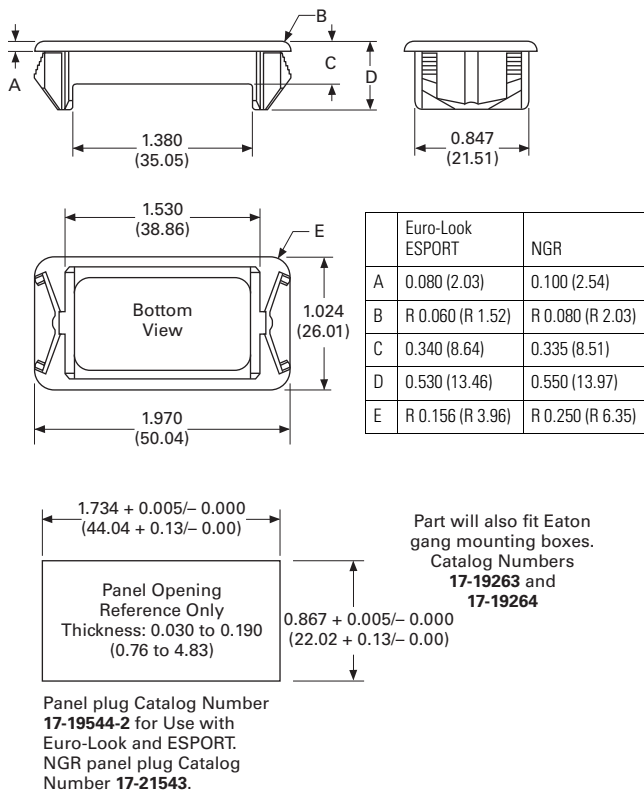

EURO SR Panel Plugs

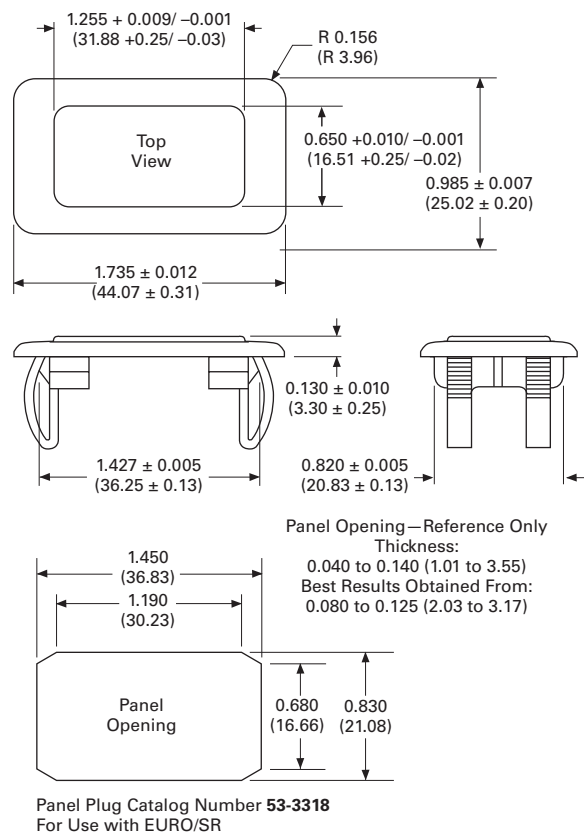

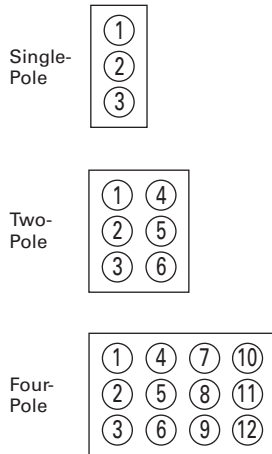

Terminal Identification

When specified on order, switches will have the terminals identified as shown in the illustration at right. Terminal markings will be ink-stamped on the side of the switch case and unused terminal positions will not be identified.

All views are rear of switch with keyway or at down as applicable. Terminal numbers 2, 2 and 5 and 5 and 8 are considered inboard terminals for single-, two- and four-pole switches respectively. All others are considered outboard.

“Three Independent” ON-ON-ON Circuit Diagram

For switch modified with “Three Independent” ON-ON-ON special circuit. External jumpers are required. User to connect wiring per instructions given below.

ON-ON-ON Special Circuit

Connection Points	Single-Pole
Connect common to terminals	2
Connect circuit “A” to terminals	6
Connect circuit “B” to terminals	4
Connect circuit “C” to terminals	1

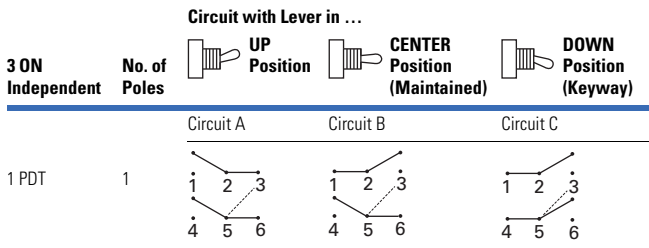

Circuit Diagrams

Rocker Circuit Diagrams

Circuit Letter	Schematic	Circuit Letter	Schematic
A 1PST		I 2 Circuit ^⑤	
B 1PDT		J 1PST	
C 2PST		K 1PDT	
D 2PDT		L 2PST	
E 4PST ^①		M 2PST	
F 4PDT ^②		N ^⑥ 2PDT	
G ^③ 1PST		P 1PDT	
H ^④ 1PDT		Q ^⑦ 2 Circuit	

Legends

Rocker Switch Legend

Legend	Rocker Switch Type
●	Contact terminal—will make contact with switch lever
○	Isolated terminal—does not make contact with lever
⌋	Center terminal and switch lever
⊗	Bulb
⤴	Momentary contact
●	Denotes mechanical contact portion

See next page for Midsize Switch Circuit Diagrams. See **Page V11-T2-17** for NGR Circuit Diagrams.

Notes

- ① Poles 11 and 12 may be eliminated for three-pole devices.
- ② Poles 10, 11 and 12 may be eliminated for three-pole devices.
- ③ Dependent lamp.
- ④ Independent lamp.
- ⑤ Two circuit—indicates a special type of double-throw switch in which the two circuits being controlled may be independent of each other.
- ⑥ For 206 Series, an additional lamp is available.
- ⑦ Available in 1PDT or 2PDT.

Midsize Switch Circuit Diagrams ^①

Non-Illuminated

Circuit Number (Circuit Designator)	Schematic	Circuit with Rocker In ...		
		DOWN Position	CENTER Position	UP Position
1 1PST		OFF	NONE	ON
2 1PST		OFF	NONE	ON
3 1PST		OFF	NONE	MOM. ON
4 1PST		OFF	NONE	ON
5 1PDT		ON	NONE	ON
6 1PDT		ON	OFF	ON
7 1PDT		MOM. ON	NONE	ON
8 1PDT		ON	OFF	MOM. ON
9 1PDT		MOM. ON	OFF	MOM. ON
10 2PST		OFF	NONE	ON
11 2PST		OFF	NONE	MOM. ON
12 2PST		MOM. OFF	NONE	ON
13 2PDT		ON	NONE	ON
14 2PDT		ON	OFF	ON
15 2PDT		MOM. ON	NONE	ON
16 2PDT		ON	OFF	MOM. ON
17 2PDT		MOM. ON	OFF	MOM. ON

Illuminated





































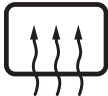





Circuit Number (Circuit Designator)	Schematic	Circuit with Rocker In ...		
		DOWN Position	CENTER Position	UP Position
18 1PST		OFF	NONE	ON
19 1PST		OFF	NONE	ON
20 1PST ^②		OFF	NONE	ON
21 1PST		OFF	NONE	MOM. ON
22 1PDT		MOM. OFF	NONE	ON
23 1PDT		ON	NONE	ON
24 1PDT		ON	OFF	ON
25 1PDT		MOM. ON	NONE	ON
26 1PDT		ON	OFF	ON
27 2PST		ON	OFF	ON
28 2PST		ON	NONE	ON
29 2PST ^③		ON	NONE	ON
30 2PDT		MOM. ON	NONE	MOM. ON
31 2PDT		ON	NONE	ON
32 Indicator		—	—	—

Notes

- ① Terminal numbers 1, 2 and 3 denote single-pole base.
Terminal numbers 11, 12, 113, 24, 25 and 26 denote two-pole base.
- ② Single-pole in two-pole base with lamp independently wired.
- ③ Two-pole—independently wired lamp.

NGR, SVR, E31, E32 and E33 eSM Symbols ^{①②}

2

Inscription	Catalog Number Suffix	Inscription	Catalog Number Suffix	Inscription	Catalog Number Suffix	Inscription	Catalog Number Suffix
	AA		AQ		BF		BU
	AB		AR		BG		BV
	AC		AS		BH		BW
	AD		AT		BI		BX
	AE		AU		BJ	OVER RIDE	BY
	AF		AV		BK		BZ
	AG		AW		BL		CA
	AH		AX		BM	(M)	CB
	AJ		AY		BN	(M) ¹ (M) ² (M) ³	CC
	AK		BA	3	BP	(M) ¹ (M) ²	CD
	AL		BB	1	BQ		CE
	AM		BC		BR		CF
	AN		BD		BS	DIAGNOSTIC SEO	CG
	AP		BE		BT	CR	CH

① Additional icons are available. Contact your local Eaton Sales Representative.

② SAE Specification No. J1362.















































NGR, SVR, E31, E32 and E33 eSM Symbols ①②

Inscription	Catalog Number Suffix	Inscription	Catalog Number Suffix	Inscription	Catalog Number Suffix	Inscription	Catalog Number Suffix
SET/COAST RES/ACCEL	CI		CX		DN		EC
REGLER/ ROUE LIBRE	CJ		CY		DP		ED
AJUSTAR	CK		DA		DQ		EE
CRUISE	CL		DB		DR	SET	EF
REPRENDRE/ ACCEL	CM		DC		DS	RESUME	EG
VOLVERA VELOCIDAD	CN		DD		DT	ETHER	EH
	CP		DE		DU		EI
	CQ		DF		DV		EJ
	CR		DG		DW		EK
	CS		DH	START	DX		EL
	CT		DJ	STOP	DY		EM
	CU		DK		DZ		EN
	CV		DL		EA	B/U CAMERA	EO
	CW		DM		EB		EP

① Additional icons are available. Contact your local Eaton Sales Representative.

② SAE Specification No. J1362.

NGR, SVR, E31, E32 and E33 eSM Symbols ^{①②}

Inscription	Catalog Number Suffix	Inscription	Catalog Number Suffix	Inscription	Catalog Number Suffix	Inscription	Catalog Number Suffix
	EQ		FE		FS	MICRO WAVE	GG
	ER		FF		FT		GH
WC	ES		FG	LOW DOCKING	FU		GI
	ET		FH	DOCKING	FV	DECEL	GJ
	EU		FI	CORNERING	FW	UNLOAD TAG	GK
	EV		FJ		FX		GL
	EW		FK		FY		GM
	EX		FL		FZ		GN
	EY		FM		GA		GP
	EZ		FN		GB		GQ
	FA		FO	TEST	GC		GR
	FB		FP		GD		GS
	FC		FQ	DEST.	GE		GT
	FD		FR	110 VOLT	GF		GU

① Additional icons are available. Contact your local Eaton Sales Representative.

② SAE Specification No. J1362.

NGR, SVR, E31, E32 and E33 eSM Symbols ①②













Inscription	Catalog Number Suffix	Inscription	Catalog Number Suffix	Inscription	Catalog Number Suffix	Inscription	Catalog Number Suffix
	GV		HM		JD	AUDIO VIDEO	JT
	GW		HN		JE		JU
	GY		HP		JF		JV
	HA		HQ	READ	JG		JW
L	HB		HR	LAMP TEST	JH		JX
R	HC		HS		JJ		JY
CRUISE ON-OFF	HD	ASR AUX	HT		JK		JZ
	HE		HU		JL		KA
	HF		HV		JM	MAX TRAN	KB
LUZ PASILLO	HG	MIRROR CLEAN	HW		JN	REMOTE CONTROL	KC
	HH		HY		JP	TRACTION CONTROL	KD
	HJ	SECUENCIA DE DIAGNOSTICO	JA		JQ	BLINK CODE	KE
DUMP DOOR	HK		JB	km/h	JR	HAND THROT	KF
	HL		JC		JS	ENG DIAG	KG

① Additional icons are available. Contact your local Eaton Sales Representative.

② SAE Specification No. J1362.

NGR, SVR, E31, E32 and E33 eSM Symbols ^{①②}

2

Inscription	Catalog Number Suffix	Inscription	Catalog Number Suffix	Inscription	Catalog Number Suffix
INTARDER	KH	GEN. START	KV	EXIT	LJ
CMU	KI	LOW 12 V.	KW	EXH BRK	LK
	KJ	LOW 110 V.	KX	24V. CHARGER	LL
CRUISE SET	KK	AIR HORN	KY	AQUA HOT	LM
HIGH IDLE	KL	STEP SLIDE	KZ	HEAT EXCHGR	LN
SANDERS	KM		LA	AIR COMPSR	LO
	KN		LB		LP
	KO	CRUISE SELECT	LC		LQ
OVER LOAD DRIVE AXLE	KP	TEST ALARMS	LD		LR
TRACTION CONTROL	KQ		LE		LS
	KR		LF	PA	LT
	KS	AUX HYD OVERHEAT	LG	G-AUX START	LU
12 V. MASTER	KT	VIDEO	LH	CNTR A/C	LV
B/U LIGHTS	KU	ENTER	LI	REAR A/C	LW

① Additional icons are available. Contact your local Eaton Sales Representative.

② SAE Specification No. J1362.

NGR Only Symbols ①②

Inscription	Catalog Number Suffix	Inscription	Catalog Number Suffix	Inscription	Catalog Number Suffix	Inscription	Catalog Number Suffix
	LX	RIGHT SCENE	ML		NB	REAR HEAT	NP
	LY	REAR SCENE	MM		NC	↑ INC.	NQ
POSITION LIGHT	LZ	STOP START	MN		ND	↓ DEC.	NR
MASTER WARN	MA	BATT IGN	MO	FRONT A/C	NE	1	NS
UPPER WARN	MB		MP	RETARDER	NF	2	NT
LOWER WARN	MC		MS	OPTCOM	NG		NU
COMPT LIGHTS	MD		MT	FUEL PRIME	NH	LEFT QTZ LT	NV
WORK LIGHTS	ME	TWO TONE HORNS	MU	AERIAL PTO	NI	RIGHT QTZ LT	NW
FAST IDLE	MF	SIREN AMP TWO TONES	MV	AIRHRN HORN	NJ	DECK LIGHT	NX
MIRROR HEAT	MG	PUMP PTO	MW	SIREN HORN	NK	ADD'L STROBE	NY
GEN PTO	MH	CRUISE	MX	Q2B HORN	NL	REAR QTZ LT	NZ
WIGWAG	MI	RES/ACCEL	MY	SIREN Q2B HORN	NM	MODE	PA
SIREN BRAKE	MJ	SET/COAST	MZ	AIRHRN Q2B HORN	NN		PB
LEFT SCENE	MK	RETARD ON/OFF	NA	AIRHRN SIREN HORN	NO		PC

① Additional icons are available. Contact your local Eaton Sales Representative.

② SAE Specification No. J1362.

NGR Only Symbols ^{①②}

























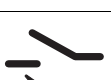













2

Inscription	Catalog Number Suffix	Inscription	Catalog Number Suffix	Inscription	Catalog Number Suffix	Inscription	Catalog Number Suffix
AUX LIGHTS	PD	VOLUME UP	PS		RG		RW
	PE	VOLUME DOWN	PT	CHECK ENGINE	RH		RX
FRONT BLIND	PF	MUTE ON	PU		RI		RY
SIDE BLIND	PG	MUTE OFF	PV		RJ		RZ
ON	PH		PW		RK		SA
OFF	PI	DISPLAY POWER	PX		RL		SB
GEN STRT STOP/PRHT	PJ	CRUISE ADJ	PY		RM		SC
B.O. SELECT	PK	HILL HOLDER	PZ	ABS CODE	RN		SD
	PL		RA		RP		SE
B.O. LIGHTS	PM	AISLE LAMPS	RB		RQ		SF
LEFT DRV	PN		RC		RS		SG
RIGHT DRV	PP		RD		RT		SH
INVERTER	PQ	OVER LOAD DRIVE AXLE	RE		RU		SJ
	PR		RF		RV		SK

① Additional icons are available. Contact your local Eaton Sales Representative.

② SAE Specification No. J1362.

NGR Only Symbols ①②

Inscription	Catalog Number Suffix	Inscription	Catalog Number Suffix	Inscription	Catalog Number Suffix	Inscription	Catalog Number Suffix
	SL	GPFU	TA		TQ		UE
	SM	CHEM ALARM	TB		TR		UF
Mode	SN		TC		TS		UG
	SP		TD		TT		UH
	SQ		TE		TU		UK
OFF ROAD TRACTION	SR		TF		TV		UL
	SS	OVER LOAD DRIVE AXLE	TG		TW		UM
	ST		TH		TX		UN
INTER-AXLE	SU		TJ		TY		UP
8X8	SV		TK		TZ		UR
	SW		TL		UA		US
	SX		TM		UB		UT
AUX HYD	SY	SUSP RECOVER	TN		UC		UU
HYD ENABLE	SZ		TP		UD		UV
							

① Additional icons are available. Contact your local Eaton Sales Representative.
② SAE Specification No. J1362.























NGR Only Symbols ^{①②}

Inscription	Catalog Number Suffix	Inscription	Catalog Number Suffix	Inscription	Catalog Number Suffix	Inscription	Catalog Number Suffix
	UW		VM		WC	MIRROR HEAT	WT
	UX		VN		WD	OVHD FAN	WU
	UY		VP		WE	CEILING LIGHTS	WV
	UZ	DOOR BYPASS	VR		WF	BATTERY BOOST	WW
	VA	VGT BRK	VS		WG	GENERATOR	WX
	VB	ASI RESET	VT		WH	DRVR SHADE	WY
	VC	CURT. UP	VU		WJ	PEDALS	WZ
	VD	CURT. DOWN	VV		WK	ATC	XA
	VE	BROOM IN	VW		WL	ENGINE BRAKE	XB
	VF	BROOM OUT	VX		WM	SHOCKS	XC
	VG	B.O. LIGHTS	VY		WN	AIR DUMP	XD
REAR	VH	ABS BLINK CODE	VZ		WP	TAG AXLE	XE
	VK	OPEN	WA	MIRROR SELECT	WR	FOG LIGHTS	XF
	VL	CLOSE	WB	T M B	WS	DIMMER	XG
		MUD/SNOW TRACTION					

① Additional icons are available. Contact your local Eaton Sales Representative.

② SAE Specification No. J1362.

NGR Only Symbols ①②

Inscription	Catalog Number Suffix	Inscription	Catalog Number Suffix	Inscription	Catalog Number Suffix	Inscription	Catalog Number Suffix
HEADLIGHTS	XH		XY	CTIS	YN	PUMP	ZC
DOCKING LIGHTS	XJ		XZ		YP	ROAD	ZD
AQUA HOT ENGINE PREHEAT	XK		YA		YQ		ZE
ENGINE BLOCK HEAT	XL		YB	IGNITION	YR	UNLOCK	ZF
PORCH LIGHT	XM		YC	ENGINE STOP	YS	LOCK	ZG
HANDLE STEP LIGHTS	XN	SILENT WATCH	YD	ENGINE START	YT	LM OVRRDE	ZH
STEP	XP		YE	CAMERA AIR	YU	E SHUT DWN	ZJ
BAY LIGHTS	XR		YF	WINDOW	YV		ZK
BATT CUTOFF	XS		YG		YW		ZL
STEP COVER	XT		YH	T-CASE LOW	YX		ZM
PASS SHADE	XU	IR SELECT	YJ	TANK 2	YY		ZN
NBC	XV	IR DRIVE	YK	TANK 1	YZ		ZP
AUX SUPPLY	XW	CRUISE	YL		ZA		ZR
	XX	ABS OFF-RD	YM		ZB		ZS

① Additional icons are available. Contact your local Eaton Sales Representative.
② SAE Specification No. J1362.

NGR Only Symbols ^{①②}

Inscription	Catalog Number Suffix	Inscription	Catalog Number Suffix	Inscription	Catalog Number Suffix	Inscription	Catalog Number Suffix
	ZT		H1		Y1	PEDALS	N2
CAMERA	ZU	HP	J1		Z1	GAUGE MODE	P2
VIDEO	ZV	F1	K1		A2	REGEN	R2
	ZW		L1	ATC OFF ROAD	B2	FRONT QTZ LT	S2
	ZX		M1		C2		T2
FRONT BRAKE	ZY		N1	120V	D2		U2
TIRE CHAINS	ZZ		P1	GAUGE UP/DWN	E2		V2
	A1		R1	GAUGE MODE	F2	ECO	W2
400V	B1		S1	ENG AFES	G2		X2
230V	C1		T1	CREW AFES	H2		Y2
MC	D1	FRONT 	U1		J2		Z2
	E1	SIDE / REAR 	V1	ABS DIAG	K2	 EXTERN	A3
	F1	B.O. SELECT	W1	HORN Q2B	L2	 INTERN	B3
	G1	IDLE 	X1	MASTER DUMP	M2	GEN ENGAGE	C3

① Additional icons are available. Contact your local Eaton Sales Representative.

② SAE Specification No. J1362.





NGR Only Symbols ①②

Inscription	Catalog Number Suffix	Inscription	Catalog Number Suffix	Inscription	Catalog Number Suffix	Inscription	Catalog Number Suffix
	D3	AIRHRN ALT AH	T3	ROTO- RAY	H4		Y4
	E3	DIFF LOCK	U3	REGEN	J4		Z4
	F3	HORN AIRHORN SIREN	V3	REGEN INHBT	K4		A5
	G3	MIL	W3		L4		B5
	H3	ATC OVRRDE	X3		M4		C5
	J3	OUTRGR LASER	Y3		N4		D5
	K3	AER QTZ LT	Z3	BODY QTZ LT	P4		E5
PEDAL 	L3	FOG LIGHTS	A4		R4		F5
PEDAL 	M3	BATTLE SHORT	B4		S4	AUX PUMP	G5
BAT XOVER	N3	MENU UP	C4		T4	TST 1	H5
BAT O/RIDE	P3	MENU DOWN	D4		U4	TST 2	J5
	Q3	ARMOR	E4		V4	TST 3	K5
HORN SIREN	R3	NO ARMOR	F4		W4	SAVE	L5
DOME LIGHT	S3	KNEEL	G4		X4	DOOR LOCK	M5

① Additional icons are available. Contact your local Eaton Sales Representative.

② SAE Specification No. J1362.







NGR Only Symbols ^{①②}

Inscription	Catalog Number Suffix	Inscription	Catalog Number Suffix	Inscription	Catalog Number Suffix	Inscription	Catalog Number Suffix
TELMA RTDR	N5	RUMBLER	C6	REAR CHUTE EXTEND	S6	Q2B AIRHORN HORN	G7
SIREN AIRHORN HORN	P5		D6D6	LEFT DUMP OPEN	T6	A	H7
PUMP PANEL LTS	Q5	GRND LT	E6	RIGHT DUMP OPEN	U6	B	J7
REAR HEATER	R5	RED INT LT	F6	REAR DUMP OPEN	V6	SCENE LT	K7
T/G OPEN	S5	WHT INT LT	G6	LEFT CHUTE RETRACT	W6		L7
HYD FILTER	T5	VAC PUMP	H6	RIGHT CHUTE RETRACT	X6	BODY UP	M7
TRANS TEMP	U5	PRESS MODE	J6	REAR CHUTE RETRACT	Y6	BODY DOWN	N7
OIL LEVEL	V5	VENT VALVE	K6	LEFT DUMP CLOSE	Z6	S/S TG RAISE	P7
PUMP	W5	DRIVER VALVE	L6	RIGHT DUMP CLOSE	A7	S/S TG LOWER	Q7
STROBE LIGHT	X5	OFFICER VALVE	M6	REAR DUMP CLOSE	B7	S/S TG LOCK	R7
WORK LIGHT	Y5	REAR VALVE	N6		C7	S/S TG UNLOCK	S7
FLASHING LIGHT	Z5	MASTER POWER	P6	PTO	D7	C/S TG RAISE	T7
CAMERA LIGHT	A6	LEFT CHUTE EXTEND	Q6		E7	C/S TG LOWER	U7
PLATFORM LEVEL	B6	RIGHT CHUTE EXTEND	R6	Q2B SIREN HORN	F7	C/S TG LOCK	V7

① Additional icons are available. Contact your local Eaton Sales Representative.



② SAE Specification No. J1362.

NGR Only Symbols ①②

Inscription	Catalog Number Suffix	Inscription	Catalog Number Suffix	Inscription	Catalog Number Suffix	Inscription	Catalog Number Suffix
C/S TG UNLOCK	W7	BODY RAISED	L8	FLUSH	A9	OFFSIDE AIRHORN OVRRD	Q9
AUTO PACK	X7	TIPPER EXTENDED	M8	TAKEDOWN LIGHTS	B9	OFFSIDE SIREN OVRRD	R9
PACKER EXTEND	Y7	PUMP ON	N8	DEC	C9	OFFSIDE Q2B OVRRD	S9
PACKER RETRACT	Z7	THR ADV	P8	VACUUM POMPE	D9	Q2B SIREN	T9
ONE PACK	A8	AUTO NEUTRAL	Q8	MODE PRESSION	E9	SIREN BRAKE	U9
TWO PACK	B8	HIGH IDLE	R8	VALVE VENTIL.	F9		V9
OUTSIDE CONTROLS	C8	HEATER	S8	VALVE C/ COND.	G9		W9
STREETSIDE TAILGATE	D8	LEFT MIRROR	T8	VALVE C/ OFF.	H9	FLUOR LIGHT	X9
CURBSIDE TAILGATE	E8	RIGHT MIRROR	U8	VALVE ARR.	J9		Y9
TAILGATE RAISE	F8	IR LIGHTS	V8	MAÎTRE	K9		Z9
TAILGATE LOWER	G8	B.O. SPOT LIGHTS	W8	POMPE	L9		1A
TAILGATE LOCK	H8	TANK TO PUMP	X8	LUMIERE TRAVAIL	M9	LOAD LIMIT	1B
TAILGATE UNLOCK	J8	THROT INC	Y8	MAITRE URGENCE	N9		1C
HOPPER FLOOD	K8	FOAM	Z8	LIGHT BAR	P9	OFF ROAD LTS	1D

① Additional icons are available. Contact your local Eaton Sales Representative.
② SAE Specification No. J1362.





































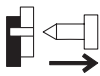

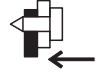



NGR Only Symbols ^{①②}

Inscription	Catalog Number Suffix	Inscription	Catalog Number Suffix	Inscription	Catalog Number Suffix	Inscription	Catalog Number Suffix
STEP LT	1E	ALLEY LT LEFT	1L	PTO ON	1S	RIGHT NOZZLE	1Y
ON OFF	1F	PLOW RAISE	1M	TAIL UP	1T		1Z
Drv Spr Nozzle	1G	PLOW LOWER	1N	OVERRIDE	1U	JAKE BRAKE	2A
Off Spr Nozzle	1H	PLOW FLOAT	1P	COMMAND LIGHT	1V	OIL TEMP	2B
Rem Noz Lt	1J	BACK-UP ALRM OVRRD	1Q	PUMP HEATER(S)	1W		2C
ALLEY LT RIGHT	1K	HOIST UP	1R	LEFT NOZZLE	1X		

① Additional icons are available. Contact your local Eaton Sales Representative.

② SAE Specification No. J1362.

SVR, E31, E32 and E33 eSM Symbols ①②

Inscription	Catalog Number Suffix	Inscription	Catalog Number Suffix	Inscription	Catalog Number Suffix	Inscription	Catalog Number Suffix
	LX	SET/CST	MM		NB		NR
	LY	SHDN OVRD	MN		NC		NS
HI RPM	MA	EXHST BRK	MP	TCS 	ND		NT
LOW RPM	MB		MQ		NE		NU
	MC		MR		NF		NV
	MD	AUTO 	MS		NG		NW
TEST (P)	ME	AUTO 	MT		NH		NX
	MF		MU	F	NJ		NY
	MG		MV	N	NK		NZ
	MH		MW	AUX WARN	NL		03
	MI		MX		NM	R	PA
	MJ		MY	I	NN		PB
	MK		MZ	OVER LOAD	NP		PC
RSM/ACC	ML		NA		NQ		PD

① Additional icons are available. Contact your local Eaton Sales Representative.
② SAE Specification No. J1362.

SVR, E31, E32 and E33 eSM Symbols ^{①②}



































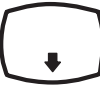

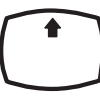





2

Inscription	Catalog Number Suffix	Inscription	Catalog Number Suffix	Inscription	Catalog Number Suffix	Inscription	Catalog Number Suffix
	PE		PT		QH		QX
	PF		PU		QJ		QY
	PG		PV		QK	SET ACCEL	QZ
	PH		PW		QL	RESUME DECEL	RA
	PI		PX		QM		RB
	PJ		PY		QN		RC
	PK		PZ		QP	WINCH	RD
	PL		QA		QQ	CRANE	RE
	PM		QB		QR	AUTO MODE	RF
	PN		QC		QS	MAN MODE	RG
	PP		QD		QT		RH
	PQ		QE		QU		RJ
	PR		QF		QV		RK
	PS		QG		QW		RL

① Additional icons are available. Contact your local Eaton Sales Representative.

② SAE Specification No. J1362.

SVR, E31, E32 and E33 eSM Symbols ①②

Inscription	Catalog Number Suffix	Inscription	Catalog Number Suffix	Inscription	Catalog Number Suffix	Inscription	Catalog Number Suffix
	RM		SB		SR	CLOSE	TF
	RN		SC		SS	OPEN	TG
	RP		SD		ST		TH
	RQ		SE		SU		TJ
	RR		SF		SV	RPM CTRL	TK
	RS		SG		SW	ON	TL
	RT		SH		SX	AUTO	TM
	RU		SJ		SY	HIGH	TN
	RV	ENG DIAG	SK		SZ	LOW	TP
	RW		SL		TA	ALARM CHEM	TQ
	RX		SM		TB	GPFU	TR
	RY		SN		TC		TS
	RZ		SP		TD	LHS	TT
	SA		SQ		TE	AUTO SPNSN	TU

① Additional icons are available. Contact your local Eaton Sales Representative.
② SAE Specification No. J1362.

SVR, E31, E32 and E33 eSM Symbols ^{①②}





























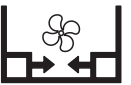















2

Inscription	Catalog Number Suffix	Inscription	Catalog Number Suffix	Inscription	Catalog Number Suffix	Inscription	Catalog Number Suffix
OBST AVOID	TV		UK		UZ		VP
	TW		UL		VA		VQ
	TX	WINCH	UM		VB		VR
	TY	CRANE	UN	FILTER	VC	FAULT	VS
PRESS CHECK	TZ		UP		VD	OK	VT
RUN FLAT	UA		UQ		VE		VU
CTIS	UB		UR		VF		VV
	UC		US		VG		VW
	UD		UT		VH		VX
	UE	F	UU		VJ		VY
	UF	LH	UV		VK	OFF	VZ
	UG	R	UW		VL	AUTO	WA
	UH	RH	UX		VM		WB
	UJ	AUX HTR	UY		VN		WC

① Additional icons are available. Contact your local Eaton Sales Representative.

② SAE Specification No. J1362.

SVR, E31, E32 and E33 eSM Symbols ①②

Inscription	Catalog Number Suffix	Inscription	Catalog Number Suffix	Inscription	Catalog Number Suffix	Inscription	Catalog Number Suffix
	WD		WT		XJ		YA
	WE		WU		XL		YB
	WF		WV		XM		YC
	WG		WX		XN	SET/RES	YD
	WH		WY	CODE	XP		YE
	WJ		WZ		XQ		YF
	WK		XA		XR		YG
	WL		XB	1	XS		YH
AUTO	WM	F	XC	2	XT	+	YJ
	WN	R	XD	3	XU	-	YK
	WP	SHIFT	XE		XV		YL
	WQ		XF		XW		YM
	WR		XG		XY		YN
	WS		XH		XZ		YP

① Additional icons are available. Contact your local Eaton Sales Representative.

② SAE Specification No. J1362.

SVR, E31, E32 and E33 eSM Symbols ^{①②}

2

Inscription	Catalog Number Suffix	Inscription	Catalog Number Suffix	Inscription	Catalog Number Suffix	Inscription	Catalog Number Suffix
	YQ		ZE		ZV	ENG COMPT	K1
	YR		ZF		ZW		L1
	YS		ZG		ZX		M1
	YT		ZH		ZY	ISO	N1
	YU		ZJ		ZZ	H	P1
	YV		ZK		A1		R1
	YW		ZL		B1		S1
	YX		ZM		C1		T1
	YY		ZN		D1		U1
	YZ		ZP		E1		V1
	ZA		ZR	RPM -	F1		W1
	ZB		ZS	RPM +	G1	DRIVER VALVE	X1
	ZC		ZT		H1	OFFICER VALVE	Y1
	ZD		ZU		J1	REAR VALVE	Z1

① Additional icons are available. Contact your local Eaton Sales Representative.

② SAE Specification No. J1362.











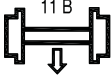





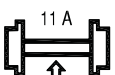



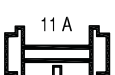

SVR, E31, E32 and E33 eSM Symbols ①②

Inscription	Catalog Number Suffix	Inscription	Catalog Number Suffix	Inscription	Catalog Number Suffix	Inscription	Catalog Number Suffix
ISO	A2		R2		G3		U3
H	B2		S2		H3		V3
	C2		T2		I3		W3
HP	D2		U2		J3		X3
HF	E2		V2		K3		Y3
	F2		W2		L3		Z3
	G2		X2		M3		A4
	H2		Y2	PUMP COMP LT	N3		B4
O/D OFF	J2		Z2		O3		C4
	K2		A3		P3		D4
	L2		B3		Q3		E4
APG	M2		C3		R3		F4
ePTO	N2		D3		S3		G4
	P2		F3		T3		H4

① Additional icons are available. Contact your local Eaton Sales Representative.
② SAE Specification No. J1362.

SVR, E31, E32 and E33 eSM Symbols ^{①②}

2

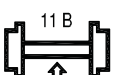
Inscription	Catalog Number Suffix	Inscription	Catalog Number Suffix	Inscription	Catalog Number Suffix	Inscription	Catalog Number Suffix
	I4		P4		V4		B5
	J4		Q4		W4		C5
	K4		R4		X4		D5
	L4		S4		Y4		X5
	M4		T4		Z4		X6
	N4		U4		A5		X7
	O4						

① Additional icons are available. Contact your local Eaton Sales Representative.

② SAE Specification No. J1362.

High Capacity Switch



Panel Board Switch



Keylock



Locking Rocker



3.1 High Capacity Switches

Product Description	V11-T3-2
Standards and Certifications	V11-T3-2
Product Selection	V11-T3-2
Technical Data and Specifications	V11-T3-2
Dimensions	V11-T3-2

3.2 Panelboard Switches

Product Description	V11-T3-3
Standards and Certifications	V11-T3-3
Product Selection	V11-T3-4
Technical Data and Specifications	V11-T3-4

3.3 Keylock Switches, General Purpose/Heavy Duty—AC/DC Rated

Product Description	V11-T3-5
Features	V11-T3-5
Product Selection	V11-T3-6
Accessories	V11-T3-7
Technical Data and Specifications	V11-T3-7
Dimensions	V11-T3-8

3.4 Locking Rocker

Product Description	V11-T3-9
Standards and Certifications	V11-T3-9
Product Selection	V11-T3-9
Technical Data and Specifications	V11-T3-10
Circuit Diagrams	V11-T3-10
Dimensions	V11-T3-10

3.1

Special Devices

High Capacity Switches

High Capacity Switch

3



Contents

Description

High Capacity Switches

Product Description

The heavy duty high capacity switch, Catalog Number 7818K1 is ideal for exceptionally high-power applications, for heavy-duty motor loads and for use in welding equipment or similar industrial applications.

By combining innovative design and quality materials, this switch is designed to carry the specified maximum inrush current for 10 milliseconds for a minimum of 20,000 ON/OFF cycles.

Standards and Certifications

- UL® to Standard 508, File E147754



Product Selection



High Capacity Switch

Description	Catalog Number
40A, 600 Vac 5 hp, 250 Vac	7818K1

Technical Data and Specifications

High Capacity Switches

Description	Specification
Circuits	2PST, maintained
Contact mechanism	Quick-make/quick-break snap acting butt contact Make: 200A peak inrush at 125 Vac for 10 ms for 20,000 cycles minimum Break: 20A at 125 Vac for 20,000 cycles minimum
Contact material	10% silver cadmium oxide composite
Terminal types	Screw—brass (Catalog Number 11-6074-4) supplied. Furnish unassembled
Mounting means	Molded flush mounting bracket, high impact polycarbonate, 3.312 in (84.12 mm), center-to-center spacing and 2.375 in (60.33 mm) spacing for self-tapping screws
Lever	Nylon
Base	Molded thermoset material
Dielectric withstand	2200V rms minimum

Dimensions

Approximate Dimensions in Inches (mm)

7818K1

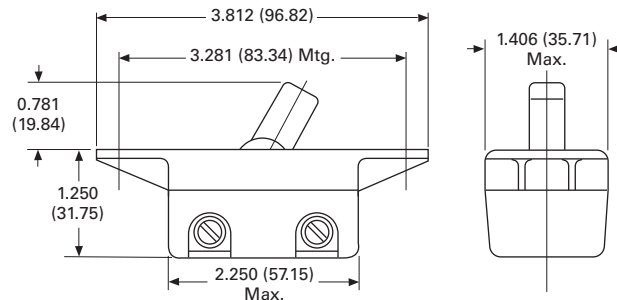

Panel Board Switches



Contents

Description

	<i>Page</i>
Panelboard Switches	
Product Selection	V11-T3-4
Technical Data and Specifications	V11-T3-4

Product Description

This group of two-position power toggle switches is used by manufacturers in a wide variety of applications that require dependability and long service, such as welding equipment, commercial floor polishers, battery chargers, food processors and panelboards.

Standards and Certifications

- UL Recognized
- CSA® Certified as noted



Product Selection

8980K1

Panelboard Switches

3



Rating	Poles and Throw	Mounting	Terminals	Catalog Number
60A, 250 Vac/Vdc 2 hp, 125–250 Vac/Vdc ^①	2PST	N/A	N/A	8980K1 ^②
30A, 250 Vac/Vdc 30A, 125V “T” 2 hp, 120–240 Vac	1P double break	Frame plate	Center bus	8980K2
30A, 250 Vac/Vdc 20A, 600 Vac 2 hp, 120–600 Vac	2PST	Panel type strap	Screw	8980K5
30A, 250 Vac/Vdc 20A, 600 Vac 2 hp, 120–600 Vac Three-phase	3PST	Panel type	Screw	8980K6
30A, 250 Vac/Vdc 2 hp, 120–240 Vac 1 hp, 480 Vac	2PST	Panel type strap	Screw	8980K14 ^③
30A, 250 Vac/Vdc 2 hp, 120–240 Vac	2PST	Panel type strap	Screw	8980K16

8980K5



Technical Data and Specifications

Panelboard Switches

Description	Specification
Rating	10–60A; 120–600V See Product Selection table
Circuits	1PST, 2PST, 3PST 2 circuit, maintained Except for Catalog Number 8980K13, momentary
Contact mechanism	Quick-make/quick-break wiping action Except for Catalog Number 8980K13, quick-make/quick-break butt contact
Contact material	Movable—bronze; stationary—copper; Catalog Number 8980K13—silver
Terminal types	Screw or bus
Termination material	Copper
Mounting means	Two-hole mounting—panel type flush
Dielectric withstand	1000 volts rms minimum
Operating temperature range	0° to 150°F (–17.8° to 65.6°C)

Notes

^① For appliance use only; 32A, 480 Vac, 25A, 600 Vac.

^② CSA Certified.

^③ Binding screws assembled. For binding screws provided unassembled, order Catalog Number 8980K30.

General Purpose and Heavy Duty Keylocks



Contents

<i>Description</i>	<i>Page</i>
Keylock Switches, General Purpose/Heavy Duty—AC/DC Rated	
Product Selection	V11-T3-6
Accessories	V11-T3-7
Technical Data and Specifications	V11-T3-7
Dimensions	V11-T3-8

Product Description

General Purpose

These keylock switches provide reliable performance in a space-saving design. They all use quick-make/quick-break switching mechanisms, with wiping action blades for self-cleaning contacts.

Heavy Duty

These switches have a slow-make/slow-break switching mechanism with large butt type contacts. Their high current switching capability allows them to be used for locking switching circuits in power applications.

Features

Termination Types

General Purpose

Solder lugs—Brass silver-plated

Heavy Duty

- 7842 Series
- Screw terminals—Brass designed to accept #7-32 x 3/16 binding head screws

Furnished unassembled

- 7846 Series
- Quick connect terminals—Brass

Mounting Means

General Purpose

Threaded bushing—0.468 in (11.89 mm) dia.

Keyway—0.062–0.067 in wide x 0.035–0.370 deep (1.55–1.70 mm wide x 0.89–0.94 mm deep)

Hardware supplied—1 hexnut (Cat. No. **15-192**) and 1 chamfered dress nut (Cat. No. **15-994-2**)

Furnished unassembled

Heavy Duty

- 7842 Series
- Slotted bushing—0.468 in (11.89 mm) dia.

Hardware supplied—4 terminal screws and 1 hexnut

Furnished unassembled

- 7846 Series
- Hardware supplied—2 hexnuts

3.3

Special Devices

Keylock Switches, General Purpose/Heavy Duty—AC/DC Rated

Product Selection

3



General Purpose Keylock AC/DC Switches

Circuit with Key in ... (Keyway Down)

Rating	Poles and Throw	LEFT Position	CENTER Position (Keyway)	RIGHT Position	Key Removal Position	Solder Lug Terminal Catalog Number
6A, 125 Vac/Vdc 3A, 250 Vac/Vdc	1PST	—	OFF	ON	CENTER	8928K492
		—	OFF	ON	CENTER and RIGHT	8928K493
6A, 125 Vac/Vdc 1A, 250 Vac/Vdc	1PDT	—	ON	ON	CENTER and RIGHT	8928K494
6A, 125 Vac/Vdc 1-1/2A, 250 Vdc	1PDT	—	ON	ON	CENTER	8283K150
6A, 125 Vac/Vdc 3A, 250 Vdc	2PST	—	OFF	ON	CENTER	8370K150
		—	ON	OFF	CENTER	8370K151
6A, 125 Vac/Vdc 3A, 250 Vac/Vdc	2PST	—	OFF	ON	CENTER and RIGHT	8928K495
6A, 125 Vac/Vdc 3A, 250 Vdc	2PDT	—	ON	ON	CENTER	8373K150
		—	ON	ON	CENTER and RIGHT	8373K151



Heavy Duty Keylock AC Rated Switches

Rating	Circuit	Action	Key Removal Position	Slotted Bushing Length		Type of Termination	Key Style	Catalog Number
				Inches	mm			
7846 Type Series								
20A, 120 Vac 20A, 240 Vac 1-1/2 hp, 120 Vac 2 hp, 240 Vac	2PST	OFF-ON-OFF-ON	OFF	0.50	12.7	Quick Connect	E (13-8173)	7846K1 ^①

Note

① Not CSA Certified.

Keylock Switches, General Purpose/Heavy Duty—AC/DC Rated

Accessories

Keys for Locking Switches

Additional keys may be ordered from the Key Selection table.

Key styles shown match those listed for specific switches in the Product Selection tables.



Key Selection

Where Used	Catalog Number
General purpose and heavy duty series	13-5496
Security locking bracket	13-8171
7846K1	13-8173

Rotary Keylock Brackets—Security Tumbler Type

This series of rotary keylock is designed for use in security applications. They provide a simple method of converting single- and two-pole toggle switches. For use with two- or three-position switches.

Key Selection

Where Used	Catalog Number
Key removable in counter-clockwise position	8980P25
Key removable in clockwise position	8980P27
Key removable in either extreme position	8980P28

Technical Data and Specifications

Keylock Switches, General Purpose/Heavy Duty—AC/DC Rated

Description	General Purpose	Heavy Duty
Circuits	1PST, 1PDT, 2PST, 2PDT Maintained action	2PST, 2-circuit maintained
Contact mechanism	Quick-make/quick-break wiping action	Slow-make/slow-break butt contact
Contact material	Movable—Bronze silver-plated Stationary—Brass silver-plated	Movable—Silver cadmium oxide Stationary—Silver cadmium oxide

Rotary Keylock Brackets

Description	Specification
Bushing	7/8 in dia., 24 threads/inch
Mounting hardware and keys	
1 hexagon locknut	Cat. No. 15-2528-2
1 bright chrome plated dress nut	Cat. No. 15-2528-2 (furnished unassembled)
2 keys	Cat. No. 13-8171
Finish	
Lock bushing	Diecast zinc
Lock barrel and dress nut	Chrome plated brass
Keys	Brass

3.3

Special Devices

Keylock Switches, General Purpose/Heavy Duty—AC/DC Rated

Dimensions

Approximate Dimensions in Inches (mm)

8928K493—1PST/1PDT

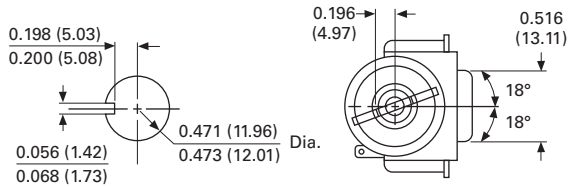

Mtg. Hole

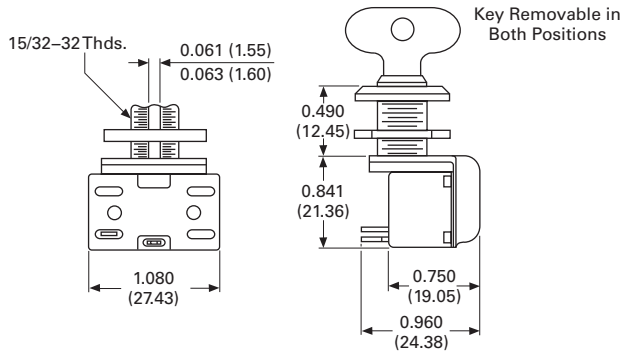

8373K151—2PST/2PDT

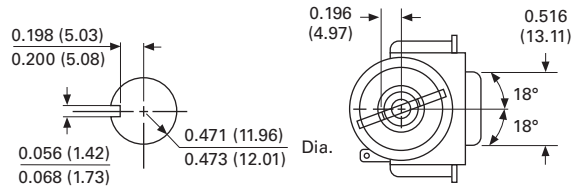

Mtg. Hole

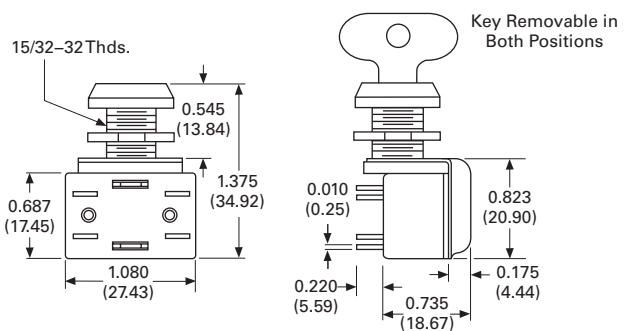

7842K2—2PST

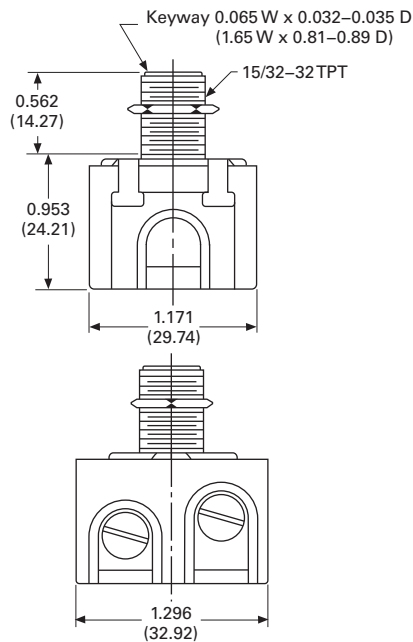

7846K1—2PST

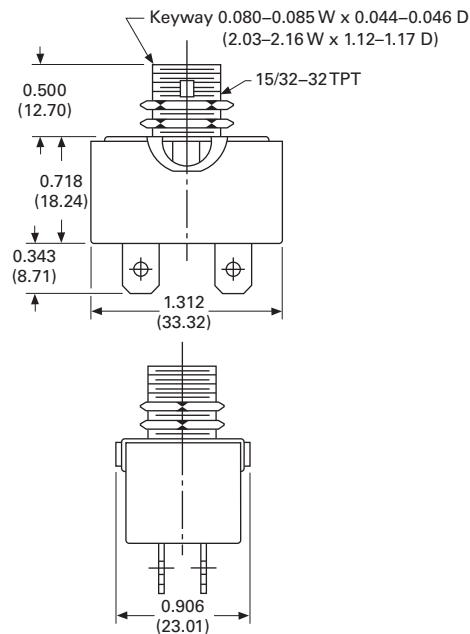

8980P27

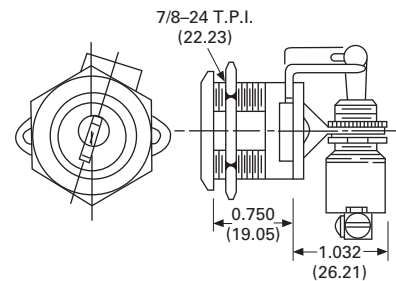

Locking Rockers



Contents

<i>Description</i>	<i>Page</i>
Locking Rockers	
Accessories	V11-T3-10
Technical Data and Specifications	V11-T3-10
Circuit Diagrams	V11-T3-10
Dimensions	V11-T3-10

Product Description

This unique switch features a patented internal locking mechanism, which allows the switch to be locked in the OFF position to prevent unauthorized or accidental operation. The key to locking

or unlocking the switch is a removable paddle rocker cap, which must be inserted in order to move the switch to the ON position. The switch can still be turned OFF.

The locking rocker is ideally suited for such markets as portable tools, computers, lawn and garden equipment, marine and construction.

Standards and Certifications

- UL Recognized
- CSA Certified
- RoHS Compliant ①



Note: Contact your local Eaton Sales Representative for selection information and optional features.

Product Selection

Locking Rocker Switch

Rating ②	Poles and Throw	Circuit with Rocker in ...			Base Circuit (See Page V11-T3-10)	Catalog Number
		UP Position	CENTER Position	DOWN Position		
Without Palm Guard Feature						
20A, 125 Vac	1PST	ON	NONE	OFF	A	8166K27
20A, 250 Vac	1PDT	ON	NONE	ON	B	8166K28
1 hp, 125 Vac	2PST	ON	NONE	OFF	C	8166K25
2 hp, 250 Vac				ON		
With Palm Guard Feature						
20A, 125 Vac	1PST	ON	NONE	OFF	A	8166K23
20A, 250 Vac	1PDT	ON	NONE	ON	B	8166K24
1 hp, 125 Vac	2PST	ON	NONE	OFF	C	8166K21
2 hp, 250 Vac				ON		

Notes

- ① Visit www.eaton.com/vcbu for the most up-to-date list of verified part numbers.
- ② Ratings listed for 125 Vac also apply at 28 Vdc. Also supplied with a 20A, 277 Vac rating as standard.

3.4

Special Devices

Locking Rockers

Accessories

53-3021-2

Replacement Cap



Description	Catalog Number
Red paddle rocker replacement cap	53-3021-2

3

Technical Data and Specifications

Locking Rocker Switch

Description	Specification
Contact mechanism	Butt action contact mechanism designed specifically for use on AC and low voltage DC applications
Contact material	Movable—Silver-plated copper w/cad-oxide contact face button Stationary—Copper w/cad-oxide contact face button
Terminal types	0.25 in spade terminals are standard
Rocker material	Custom styled, red thermoplastic rocker key with "REMOVE TO LOCK" across the top of the key in raised letters
Dielectric	1000V rms minimum

Circuit Diagrams

Locking Rocker Circuit Diagrams

Circuit Letter	Schematic	Circuit Letter	Schematic
A 1PST		C 2PST	
B 1PDT		D 2PDT	

Dimensions

Approximate Dimensions in Inches (mm)

Locking Rocker Switch without Palm Guard

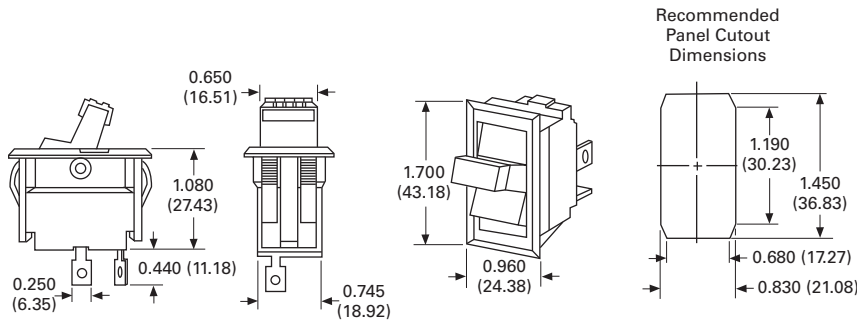

Locking Rocker Switch with Palm Guard

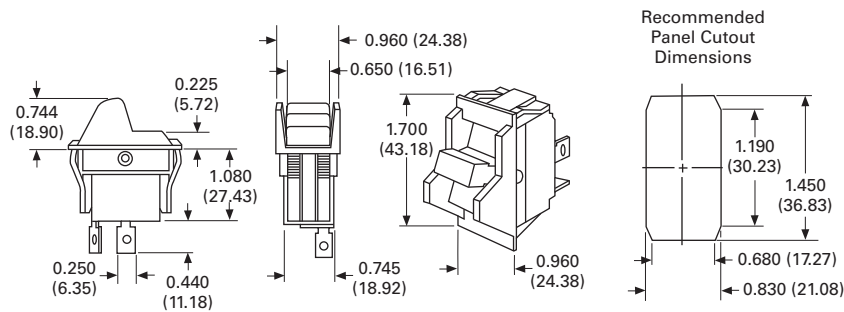

Military



Illuminated AC Rated



General Purpose AC/DC Rated



X Series Toggles



4.1	Introduction	
	Product Selection Guide	V11-T4-2
4.2	Military Purpose Toggles	
	Product Selection	V11-T4-3
	Technical Data and Specifications	V11-T4-6
	Dimensions	V11-T4-7
4.3	Illuminated AC Rated Toggles	
	Catalog Number Selection	V11-T4-9
	Technical Data and Specifications	V11-T4-10
	Dimensions	V11-T4-10
4.4	General Purpose Toggles—AC Rated	
	Product Selection	V11-T4-12
	Technical Data and Specifications	V11-T4-16
	Dimensions	V11-T4-16
4.5	General Purpose Toggles—AC/DC Rated	
	Product Selection	V11-T4-20
	Technical Data and Specifications	V11-T4-21
	Dimensions	V11-T4-21
4.6	X Series Toggles	
	Product Description	V11-T4-24
	Accessories	V11-T4-25
	Technical Data and Specifications	V11-T4-25
	Dimensions	V11-T4-26
4.7	Heavy Duty Hesitation Switches	
	Product Description	V11-T4-27
	Technical Data and Specifications	V11-T4-29
	Dimensions	V11-T4-29
4.8	Accessories	
	Mounting Hardware	V11-T4-31
	Decorator Facenuts	V11-T4-33
	Panel Seal	V11-T4-33
	Replacement Terminal Screws	V11-T4-33
	Indicating Plates	V11-T4-34
4.9	Technical Data	
	Circuit Diagrams	V11-T4-35

Toggle Switches









Contents

Description

Military Purpose Toggles	V11-T4-3
Illuminated AC Rated Toggles	V11-T4-9
General Purpose Toggles—AC Rated.	V11-T4-11
General Purpose Toggles—AC/DC Rated.	V11-T4-20
X Series Toggles	V11-T4-24
Heavy Duty Hesitation Switches	V11-T4-27
Accessories	V11-T4-31
Technical Data	V11-T4-35

Product Selection Guide

Toggle Switches

	Military Purpose Toggles	Illuminated AC Rated Switches	General Purpose Toggles—AC Rated
			
Product Selection	Page V11-T4-3	Page V11-T4-9	Page V11-T4-20
Circuit Diagram	Page V11-T4-35	—	Page V11-T4-35
Product Description	Eaton's military purpose switches are designed to meet the requirements of MIL-S-83731	These illuminated switches are available only in single-pole circuitry. A two-pole base is utilized with single-pole housing the lamp.	These AC rated toggle switches offer the widest selection of features and the design flexibility to meet a variety of applications.
	General Purpose Toggles—AC/DC Rated	X Series Toggles	Heavy Duty Hesitation Switches
			
Product Selection	Page V11-T4-20	Page V11-T4-24	Page V11-T4-27
Circuit Diagram	Page V11-T4-35	—	Page V11-T4-35
Product Description	This line of switches employs a quick-make/quick-break contact mechanism. These switches are especially suited for use in small motor applications.	Eaton's new, competitively priced, AC rated X Series toggles offer a standard high rating for both single- and two-pole applications.	The most common application for this switch is to help prevent motor damage resulting from the high current generation by counter EMF of the armature at the time of reversing.

Military Purpose Toggles



Contents

Description

Military Purpose Toggles	
Technical Data and Specifications	V11-T4-6
Dimensions	V11-T4-7

Product Description

Eaton's military purpose switches are designed to meet the requirements of MIL-S-83731. Sealed Switches have a silicone rubber lever seal assembled between the lever and the bushing to resist the entrance of contaminants such as dust, sand or water into the contact structure.

The switch mechanisms are completely enclosed to resist the entrance of contaminants into the switch. All metal parts are plated to resist corrosion. The heavy duty switches are offered in both standard toggle lever and lever lock versions. Circuit designations are stamped on the side of each switch.

Standards and Certifications

- MIL-S-83731

Product Selection

AC/DC Rated (Medium Duty) MIL-S-83731



Current Ratings	Poles and Throw	Circuit with Toggle in ...			Base Circuit See Page V11-T4-35	Dimension "A" Inches (mm)	Dimension "B" Inches (mm)	Military Solder Lug Terminals	
		UP Position	CENTER Position	DOWN Position (Keyway)				MIL-S-83731 with Sealed Lever	Catalog Number
Single-Pole									
See A below	1PST	ON ON OFF	NONE NONE NONE	OFF MOM. OFF MOM. ON	A	—	0.906 (23.01)	MS25098-22 MS25098-29 MS25098-30	8261K22 8261K29 8261K30
See A below	1PDT	ON ON	NONE NONE	ON MOM. ON	B	0.937 (23.80)	—	MS25098-23 MS25098-26	8261K23 8261K26
Two-Pole									
See B below	2PST	ON ON OFF	NONE NONE NONE	OFF MOM. OFF MOM. ON	C	—	0.906 (23.01)	MS25100-22 MS25100-29 MS25100-30	8262K22 8262K29 8262K30
See C below	2PDT	ON ON	NONE NONE	ON MOM. ON	D	0.937 (23.80)	—	MS25100-23 MS25100-26	8262K23 8262K26

Current Ratings

Part Number	Current Capacity in Amperes per Pole = 125 Vac, 60 Hz	
	Resistive Load	Inductive Load
A All MS25098	3.0	1.5
B MS25100-22, 29, 30	3.0	1.5
C MS25100-23, 26	1.0	1.0



AC Rated (Heavy Duty) MIL-S-83731 with Lever Seal

4

Current Ratings	Poles and Throw	Circuit with Toggle in ...			Base Circuit See Page V11-T4-35	Bushing Length "A" Inches (mm)	Lever Length "B" Inches (mm)	Screw Terminals with Sealed Lever	
		UP Position	CENTER Position	DOWN Position (Keyway)				MS Part Number	Catalog Number
Single-Pole									
See A below	1PST	ON	NONE	OFF	A	0.468 (11.89)	0.687 (17.45)	MS35058-22	8801K22
See B below		ON	OFF	NONE				MS35058-24	8801K23
See B below		ON	NONE	MOM. OFF				MS35058-29	8813K17
See B below		ON	MOM. OFF	NONE				MS35058-25	8813K18
See B below		NONE	OFF	MOM. ON				MS35058-28	8811K18
See B below	OFF	NONE	MOM. ON	MS35058-30	8811K17				
See A below	1PDT	ON	OFF	ON	B	0.468 (11.89)	0.687 (17.45)	MS35058-21	8800K16
See B below		ON	NONE	ON				MS35058-23	8810K15
See B below		ON	NONE	MOM. ON				MS35058-26	8804K13
See B below		MOM. ON	OFF	MOM. ON				MS35058-27	8812K14
See B below		ON	OFF	MOM. ON				MS35058-31	8809K16
Two-Pole									
See C below	2PST	ON	NONE	OFF	C	0.468 (11.89)	0.687 (17.45)	MS35059-22	8822K20
See D below		ON	OFF	NONE				MS35059-24	8822K21
See D below		ON	NONE	MOM. OFF				MS35059-29	8828K13
See D below		ON	MOM. OFF	NONE				MS35059-25	8828K12
See D below		NONE	OFF	MOM. ON				MS35059-28	8826K14
See D below	OFF	NONE	MOM. ON	MS35059-30	8826K15				
See C below	2PDT	ON	OFF	ON	D	0.468 (11.89)	0.687 (17.45)	MS35059-21	8820K16
See D below		ON	NONE	ON				MS35059-23	8824K14
See D below		ON	NONE	MOM. ON				MS35059-26	8830K13
See D below		MOM. ON	OFF	MOM. ON				MS35059-27	8834K5
See D below		ON	OFF	MOM. ON				MS35059-31	8832K6
See E below	1P3T in a 2P base	ON ^①	ON ^②	ON ^④	See Page V11-T4-35	0.468 (11.89)	0.687 (17.45)	MS25201-4	8860K4
See E below		ON ^①	ON ^②	MOM. ON ^④				MS25201-5	8860K5
See E below		MOM. ON ^①	ON ^②	MOM. ON ^④				MS25201-6	8860K6
See E below		ON ^①	ON ^③	ON ^④				MS25201-7	8860K7 ^⑤
See E below		ON ^①	ON ^③	MOM. ON ^④				MS25201-8	8860K8 ^⑤
See E below		MOM. ON ^①	ON ^③	MOM. ON ^④				MS25201-9	8860K9 ^⑤
Four-Pole									
See F below	4PST	ON	NONE	OFF	E	0.468 (11.89)	0.687 (17.45)	—	7660K12
See G below		ON	OFF	NONE				MS25068-24	7660K13
See G below		ON	MOM. OFF	NONE				MS25068-25	7668K7
See G below		NONE	OFF	MOM. ON				MS25068-28	7666K9
See G below	OFF	NONE	MOM. ON	—	7666K6				
See F below	4PDT	ON	OFF	ON	F	0.468 (11.89)	0.687 (17.45)	MS25068-21	7662K7
See G below		ON	NONE	ON				MS25068-23	7664K5
See G below		ON	NONE	MOM. ON				MS25068-26	7674K5
See G below		MOM. ON	OFF	MOM. ON				MS25068-27	7672K5
See G below	ON	OFF	MOM. ON	MS25068-31	7670K6				

Current Ratings

Switch	Type of Operation	Current Capacity in Amperes per Pole									
		28 Vdc			115 Vac, 60 Hz			115 Vac, 400 Hz			
		Lamp Load	Resistive Load	Inductive Load	Lamp Load	Resistive Load	Inductive Load	Lamp Load	Resistive Load	Inductive Load	
A	MS35058	Maintained	7	25	15	—	10	10	3	10	10
B	MS35058	Momentary	5	20	10	—	10	7	—	—	—
C	MS35059	Maintained	7	20	15	—	20	—	4	20	15
D	MS35059	Momentary	5	18	10	—	11	—	—	—	—
E	MS25201	ON-ON-ON	5	18	10	2	11	8	2	11	8
F	MS25068	Maintained	5	20	12	—	—	—	4	20	15
G	MS25068	Momentary	4	18	10	—	—	—	2	11	5

Notes

- ① Across terminals 2-3 and 5-6.
- ② Across terminals 1-2 and 5-6.
- ③ Across terminals 2-3 and 4-5.
- ④ Across terminals 1-2 and 4-5.
- ⑤ For "INDEPENDENT ON-ON-ON" circuit arrangement, see Page V11-T4-35.

AC Rated (Heavy Duty) MIL-S-83731 Lever Lock with Lever Seal



Current Ratings	Poles and Throw	Circuit with Toggle in ...			Base Circuit See Page V11-T4-35	Lever Lock Bushing Style ^①	Bushing Length "A" Inches (mm)	Lever Lock Length "B" Inches (mm)	Screw Terminals with Sealed Lever	
		UP Position	CENTER Position	DOWN Position					MS Part Number	Catalog Number
Single-Pole										
See A below	1PST	ON	NONE	← OFF	A	3	0.562 (14.27)	1.000 (25.40)	MS25125-C2	8857K47
		ON →	NONE	← OFF		4			MS25125-E2	8857K48
		ON →	← OFF	NONE		5			MS25125-J4	8857K49
See A below	1PDT	ON	← OFF →	ON	B	2	0.562 (14.27)	1.000 (25.40)	MS25125-B1	8857K40
		ON	NONE	← ON		3			MS25125-C3	8857K45
		ON →	NONE	← ON		4			MS25125-E3	8857K44
Two-Pole										
See B below	2PDT	ON →	← OFF →	← ON	C	1	0.562 (14.27)	1.000 (25.40)	MS25126-A1	8858K39
		ON	← OFF →	ON		2			MS25126-B1	8858K40
		ON →	NONE	← ON		4			MS25126-E3	8858K44
Four-Pole										
See C below	4PDT	ON →	NONE	← ON	F	4	0.562 (14.27)	1.000 (25.40)	MS25127-E3	8859K44

← Indicates direction against which lever is locked.

Current Ratings

Switch	MS Part Number	Type of Operation	Current Capacity in Amperes per Pole								
			28 Vdc			115 Vac, 60 Hz			115 Vac, 400 Hz		
			Lamp Load	Resistive Load	Inductive Load	Lamp Load	Resistive Load	Inductive Load	Lamp Load	Resistive Load	Inductive Load
A	MS25125	Maintained	5	20	15	—	—	—	3	10	10
B	MS25126	Maintained	7	20	15	—	—	—	4	20	15
C	MS25127	Maintained	5	20	15	—	—	—	4	20	15

Note

① See illustrations below for lever lock bushing styles.

Lever Lock Bushing Styles

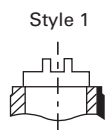

Locked in Three Positions

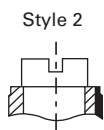

Locked in Center Positions

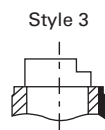

Locked in Keyway Side

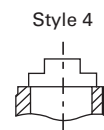

Locked out of Center Position

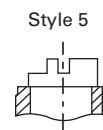

Locked in Center and Side Opposite Keyway

These illustrations are for pictorial representation only—keyway on right-hand side.

AC Rated (Heavy Duty) Military with Unsealed Lever

4



Current Ratings	Poles and Throw	Circuit with Toggle in ...			Base Circuit See Page V11-T4-35	Bushing Length "A" Inches (mm)	Lever Length "B" Inches (mm)	Solder Lug Terminals Catalog Number	Screw Terminals Catalog Number
		UP Position	CENTER Position	DOWN Position (Keyway)					
Single-Pole									
See A below	1PST	ON	NONE	OFF	A	0.468 (11.89)	0.688 (17.45)	7300K38	7300K36
See B below		ON	NONE	MOM. OFF				7304K38	7304K36
		OFF	NONE	MOM. ON				7303K38	7303K36
See A below	1PDT	ON	OFF	ON	B	0.468 (11.89)	0.688 (17.45)	7301K38	7301K36
		ON	NONE	ON				7302K38	7302K36
See B below		ON	NONE	MOM. ON				7307K38	7307K36
		MOM. ON	OFF	MOM. ON				7306K38	7306K36
		ON	OFF	MOM. ON				7305K38	7305K36
Two-Pole									
See C below	2PST	ON	NONE	OFF	C	0.468 (11.89)	0.688 (17.45)	7310K38	7310K36
See D below		ON	NONE	MOM. OFF				7314K38	7314K36
		OFF	NONE	MOM. ON				7313K38	7313K36
See C below	2PDT	ON	OFF	ON	D	0.468 (11.89)	0.688 (17.45)	7311K38	7311K36
		ON	NONE	ON				7312K38	7312K36
See D below		ON	NONE	MOM. ON				7317K38	7317K36
		MOM. ON	OFF	MOM. ON				7316K38	7316K36
		ON	OFF	MOM. ON				7315K38	7315K36

Current Ratings

Type of Operation	Current Capacity in Amperes per Pole								
	30 Vdc			125 Vac, 60 Hz			250 Vac, 60 Hz		
	Lamp Load	Resistive Load	Inductive Load	Resistive Load	Inductive Load	Horsepower	Resistive Load	Inductive Load	Horsepower
Single-Pole									
A Maintained	5	20	15	15	—	—	6	—	—
B Momentary	4	15	10	15	—	—	6	—	—
Two-Pole									
C Maintained	7	30	15	25	—	—	9	—	—
D Momentary	5	20	10	15	—	—	6	—	—

Technical Data and Specifications

Military Purpose Switches

Description	Specification
Ratings	See Product Selection tables
Circuits	1PST, 1PDT, 2PST, 2PDT, 1P3T (ON-ON-ON), 4PST and 4PDT; maintained and momentary action
Contact action	Heavy duty—Slow-make/slow-break butt contact Medium duty—Quick-make/quick-break, wiping action
Contact material	Heavy duty: Movable—silver-plated copper with fine or coin silver contact face button Stationary—copper with fine or coin silver contact face button Medium duty: Movable—copper silver-plated Stationary—bronze silver-plated
Terminal types	Heavy duty MIL-S-83731 types: Screw terminals—brass designed to accept #6-32 x 6.35 mm (0.250 in) pan head (Catalog Number 11-1893) screws and Si bronze #6 helical lockwasher (Catalog Number 16-1096). Furnished unassembled. Terminal screws are tin dipped to facilitate soldering if required Heavy duty JAN-S-23 types: Screw terminals—brass designed to accept #6-32 x 4.78 mm (0.188 in) binding head (Catalog Number 811-2) screws. Furnished unassembled Solder lug terminals—tintillate plated brass Medium duty MIL-S-83731 types: Solder lugs—brass silver-plated furnished with 0.094 in (2.39 mm) dia. hole
Base material	Thermoset molding material
Mounting means	Threaded bushing—0.468 in (11.89 mm) dia., 32 threads/inch Keyway—0.068 x 0.035 in (1.73 x 0.89 mm) deep; provides anti-rotation feature Hardware supplied: MIL-S-83731 types—2 hexagon facenuts (Catalog Number 15-966-6), 1 locking ring (Catalog Number 29-761) and 1 internal tooth lockwasher (Catalog Number 16-886). Furnished unassembled JAN-S-23 types—2 hexagon facenuts (Catalog Number 15-966-6). Furnished unassembled
Dielectric	1000V minimum
Operating temperature range	0° to 150°F (–17.8° to 65.6°C)

Dimensions

Approximate Dimensions in Inches (mm)

AC/DC Rated (Medium Duty) MIL-83731 Switches

1PDT Maintained Action (Solder Lug)

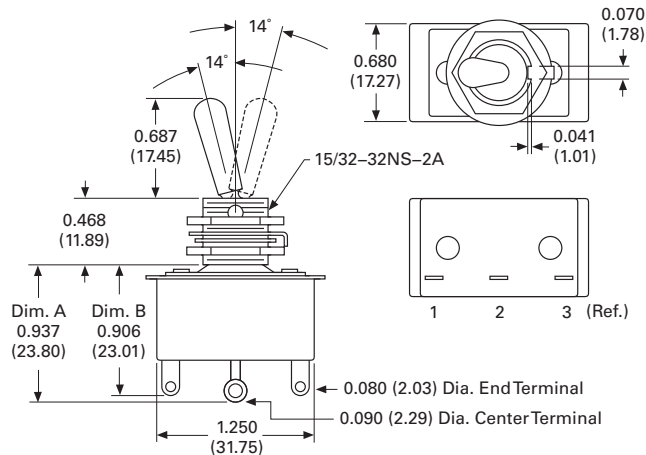

2PDT Maintained Action (Solder Lug)

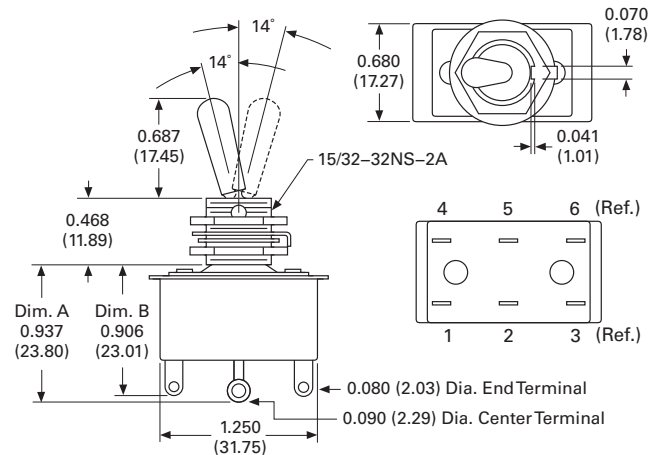

AC Rated (Heavy Duty) MIL-83731 Switches with Lever Seal

Single-Pole Maintained and Momentary Action

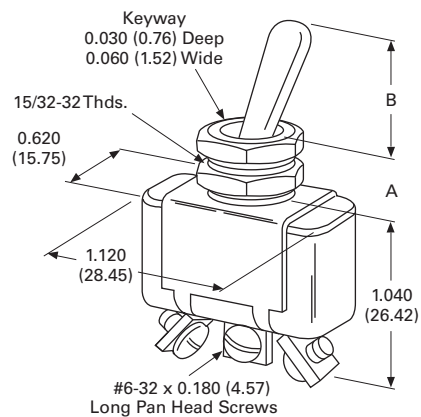

Two-Pole Maintained Action

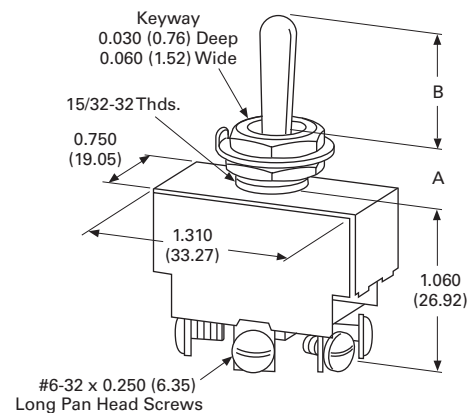

Two-Pole Momentary Action and 3 ON Circuits

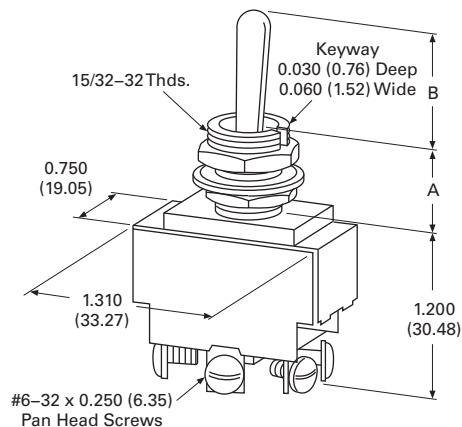

Four-Pole Maintained and Momentary Action

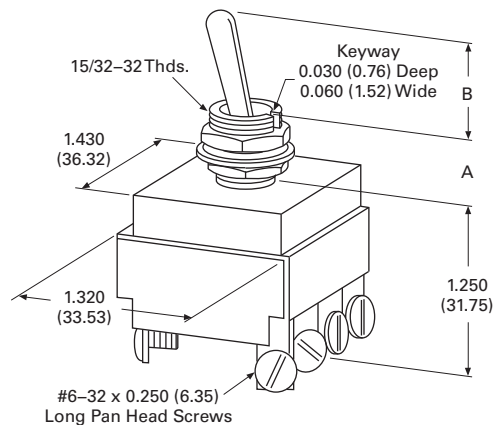

4.2

Toggle Switches

Military Purpose Toggles

Approximate Dimensions in Inches (mm)

AC Rated (Heavy Duty) MIL-83731 Lever Lock Switches with Lever Seal

Single-Pole

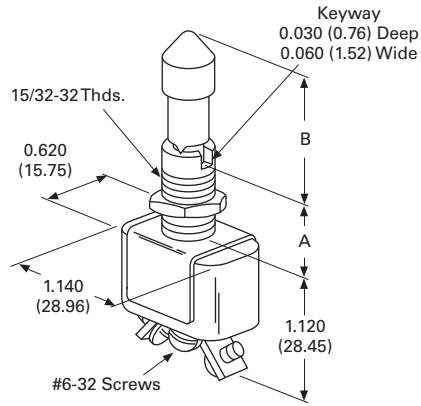

AC Rated (Heavy Duty)

1PDT Maintained Action

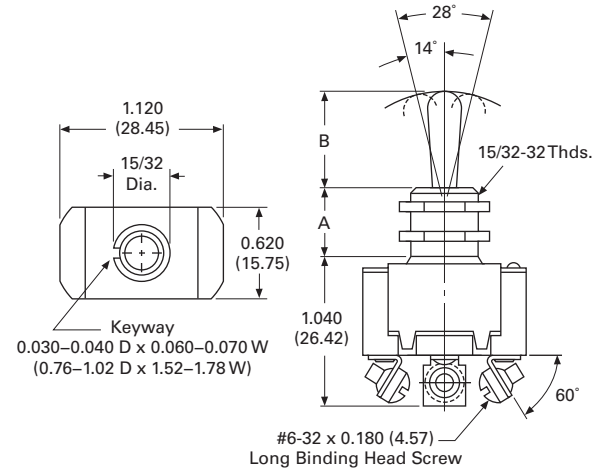

Two-Pole

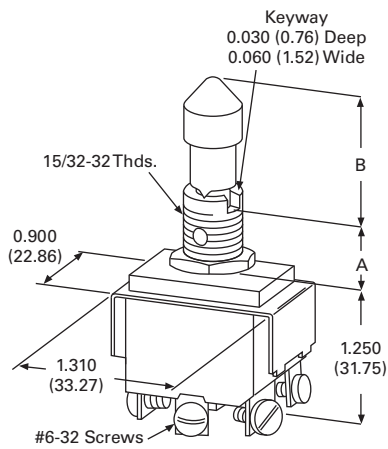

2PDT Maintained Action

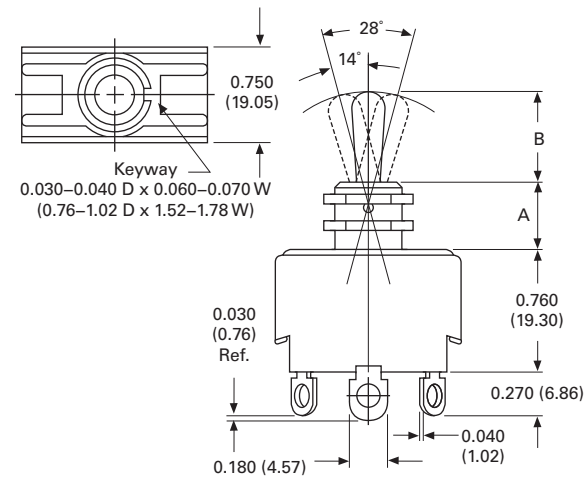

Four-Pole

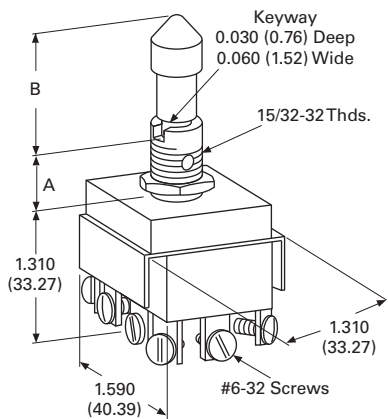

2PDT Momentary Action

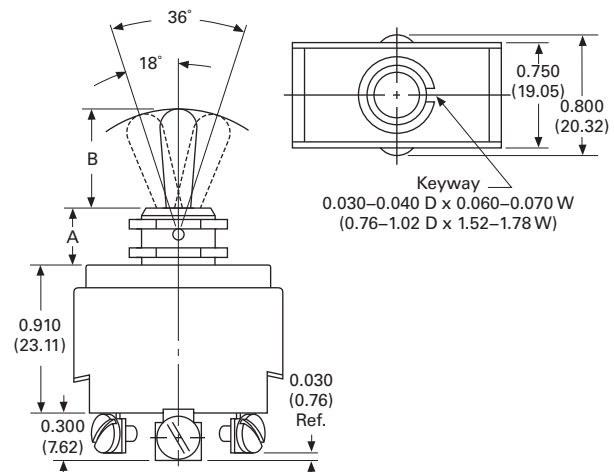

Illuminated AC Rated Toggles



Contents

Description

Illuminated AC Rated Switches	<i>Page</i>
Technical Data and Specifications	V11-T4-10
Dimensions	V11-T4-10

Product Description

These illuminated toggles are available only in single-pole circuitry. A two-pole base is utilized with single-pole housing the lamp. On single-throw circuits, the lamp is wired to operate in conjunction with the switch.

On double-throw circuits, the lamp is independent of the switch. On the sealed versions, a silicone rubber seal is fitted to the paddle lever to provide a moisture- and dust-resistant seal between the lever and bushing.

Catalog Number Selection

How To Order—Illuminated AC Rated Toggles

Example: **7071K21** → **G 1 52**

Rating	Poles and Throw	Circuit with Toggle in ...			Base Catalog Number	Circuit Number See Page V11-T4-35
		UP Position	CENTER Position	DOWN Position (Keyway)		
Standard						
15A, 125 Vac 10A, 250 Vac 3/4 hp, 250 Vac	1PST	ON	NONE	OFF	7071K21	G
Sealed						
15A, 125 Vac 10A, 250 Vac 3/4 hp, 250 Vac	1PST	ON	NONE	OFF	7073K21	G
	1PDT	ON MOM. ON	OFF OFF	ON MOM. ON	7073K20 7073K25	H

Code letters and/or numbers—add to base circuit number.

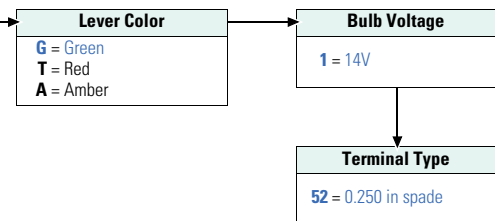

Technical Data and Specifications

Illuminated AC Rated Toggles

Description	Specification
Ratings	See Catalog Number Selection
Circuits	1PST and 1PDT; maintained and momentary action
Contact material	Movable—silver-plated copper Stationary—silver-plated copper
Terminal types	Spade—brass
Base material	Colored thermoplastic paddle lever

4

Dimensions

Approximate Dimensions in Inches (mm)

Illuminated

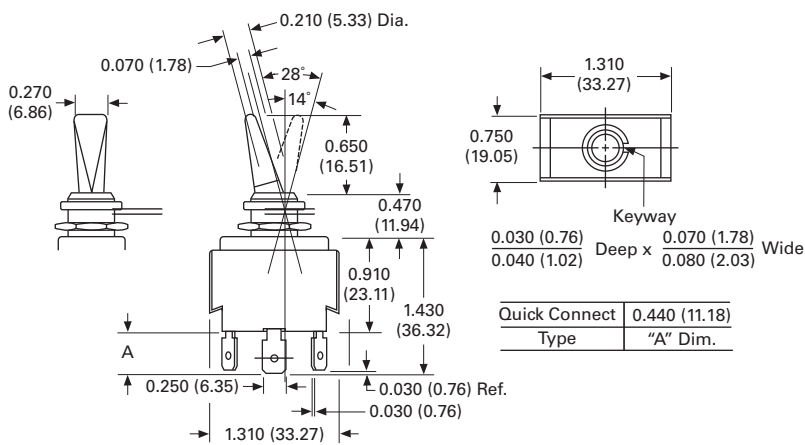

General Purpose Toggles



Product Description

These AC rated toggle switches offer the widest selection of features and the design flexibility to meet a variety of applications.

Features

The optional features shown below may not be available on all toggle models. Contact your local Eaton Sales Representative.

7500, 7600, 7700 and 7900 Series

- 3-independent ON Circuit (2PDT or 4PDT only, see **Page V11-T4-14**)
- Short (11/32 in) bushing
- Tall (15/32 in) bushing
- White nylon designer lever, see Dimensions on **Page V11-T4-16**
- Black nylon designer lever, see Dimensions on **Page V11-T4-16**
- Hardware—furnished assembled
- Reversing jumpers (not for use with 3-independent ON circuit)
- Short (15/32 in) bat lever
- Tall (11/16 in) bat lever (not available with short bushing)
- Rotate keyway 180°
- Lever seal
- Omit one pole (2P, 3P, 4P only. Not for use with 3-independent ON circuit)

Contents

Description

General Purpose Toggles—AC Rated

	<i>Page</i>
Product Selection	V11-T4-12
Technical Data and Specifications	V11-T4-16
Dimensions	V11-T4-16

Options

Combi-Term Option

This is an extension of our AC rated general purpose toggle switch. The “Combi-Term” design allows the user the option of screw terminals, 0.25 in quick connects or solder termination all on the same switch. The special clips and screws are provided in a poly bag with the switch.

Circuits

- 1PST, 1PDT, 2PST, 2PDT, 3PST, 3PDT, 4PST and 4PDT
- Maintained and momentary

Standards and Certifications

- UL® Recognized
- CSA® Certified (except as noted)
- RoHS Compliant ①



Note

① Visit www.eaton.com/vcbu for the most up-to-date list of verified part numbers.

4.4

Toggle Switches

General Purpose Toggles—AC Rated

Product Selection

4



AC Rated Toggle Switches—Single-Pole

Rating	Poles and Throw	Circuit with Toggle in ...			Base Circuit See Page V11-T4-35	Bushing Length "A" Inches (mm)	Lever Length "B" Inches (mm)	Catalog Number		
		UP Position	CENTER Position	DOWN Position (Keyway)				Solder Lugs	Screw Terminals	0.250 in Spade Terminals
6A, 125 Vac 3A, 250 Vac	1PST	ON	NONE	OFF	A	0.344 (8.74) 0.469 (11.91)	0.563 (14.30) 0.563 (14.30)	7580K7 7580K6	7580K5 7580K4	7580K9 7580K8
	1PDT	ON	OFF	ON	B	0.469 (11.91)	0.563 (14.30)	7581K6	7581K4	7581K8
	1PDT	ON	NONE	ON	B	0.469 (11.91)	0.563 (14.30)	7582K6	7582K4	7582K8
	1PDT	ON MOM. ON	NONE OFF	MOM. ON MOM. ON	B	0.469 (11.91)	0.563 (14.30)	7585K6 7587K6	7585K4 7587K4	7585K8 7587K8
10A, 250 Vac 1/2 hp, 250 Vac	1PST	OFF	NONE	MOM. ON	A	0.469 (11.91)	0.563 (14.30)	7506K3	7506K4	7506K6
	1PST	OFF	NONE	MOM. ON	A	0.469 (11.91)	0.688 (17.48)	7506K38	7506K36	7506K40
	1PDT	MOM. ON ON	OFF NONE	MOM. ON MOM. ON	B	0.469 (11.91)	0.563 (14.30)	7509K4 7510K6	7509K5 7510K7	7509K7 7510K9
	1PDT	ON MOM. ON	OFF OFF	MOM. ON MOM. ON	B	0.469 (11.91)	0.688 (17.48)	7508K38 7509K38	7508K36 7509K36	7508K40 7509K40
15A, 125 Vac 10A, 250 Vac 3/4 hp, 250 Vac 1/2 hp, 125V Vac	1PST	ON	NONE	OFF	A	0.344 (8.74) 0.469 (11.91)	0.563 (14.30) 0.563 (14.30)	7501K12 7501K13	7500K13 ^① 7500K14 ^①	7501K14 7501K15
	1PDT	ON	OFF	ON	B	0.469 (11.91)	0.563 (14.30)	7503K13 ^①	7502K13	7503K15
10A, 250 Vac 1/2 hp, 125 Vac 3/4 hp, 250 Vac	1PDT	ON	NONE	ON	B	0.469 (11.91)	0.563 (14.30)	7505K4	7504K4 ^①	7505K6
	1PST	ON	NONE	OFF	A	0.469 (11.91)	0.688 (17.48)	7546K38	7546K36	7546K40
20A, 125 Vac 10A, 250 Vac 1/2 hp, 125 Vac 3/4 hp, 250 Vac	1PST	ON	NONE	OFF	A	0.469 (11.91)	0.688 (17.48)	7546K38	7546K36	7546K40
30A, 125 Vac 25A, 250 Vac ^②	1PST	ON	NONE	OFF	A	0.344 (8.74)	0.563 (14.30)	—	7576K2	—

Notes

- ① Also 4.2A L at 125 Vac rating.
- ② Single-pole switch in two-pole base.

AC Rated Toggle Switches—Two-Pole



Rating	Poles and Throw	Circuit with Toggle in ...			Base Circuit See Page V11-T4-35	Bushing Length "A" Inches (mm)	Lever Length "B" Inches (mm)	Catalog Number			
		UP Position	CENTER Position	DOWN Position (Keyway)				Solder Lugs	Screw Terminals	0.250 in Spade Terminals	Combi-Term
6A, 125 Vac 3A, 250 Vac 2A, 277 Vac 2.5A, L at 125 Vac	2PST	ON	NONE	OFF	C	0.469 (11.91)	0.563 (14.30)	7590K6	7590K4	7590K8	—
6A, 125 Vac 3A, 250 Vac 2.5A, L at 125 Vac	2PDT	ON	OFF	ON	D	0.469 (11.91)	0.563 (14.30)	7591K6	7591K4	7591K8	—
	2PDT	ON	NONE	ON	D	0.469 (11.91)	0.563 (14.30)	7592K6	7592K4	7592K8	—
6A, 125 Vac 3A, 250 Vac	2PDT	MOM. ON	OFF	MOM. ON	D	0.469 (11.91)	0.563 (14.30)	7597K6	7597K4	7597K8	—
	2PDT	ON	ON	OFF	7530	0.469 (11.91)	0.563 (14.30)	7530K1	7530K3	7530K2	—
10A 250 Vac, 15A 125 Vac, 1/4 hp 125–250 Vac	2PDT	ON	ON	ON	7555	0.469 (11.91)	0.563 (14.30)	7555K12	7555K11	7555K13	—
15A, 125 Vac 10A, 250 Vac 3/4 hp, 250 Vac 1/2 hp, 125 Vac	2PST	ON	NONE	OFF	C	0.344 (8.74)	0.563 (14.30)	7561K5	7560K6	7561K7	—
						0.469 (11.91)	0.563 (14.30)	7561K4	7560K5	7561K6	
15A, 125 Vac 10A, 250 Vac 3/4 hp, 125–250 Vac	2PDT	ON	OFF	ON	D	0.344 (8.74)	0.563 (14.30)	7563K5	7562K5	7563K7	—
						0.469 (11.91)	0.563 (14.30)	7563K4	7562K4	7563K6	
15A, 125 Vac 10A, 250 Vac 3/4 hp, 250 Vac	2PDT	ON	NONE	ON	D	0.469 (11.91)	0.563 (14.30)	7565K5	7564K6	7565K7	—
15A, 125 Vac 10A, 250 Vac 1/2 hp, 250 Vac	2PST	OFF	NONE	MOM. ON	C	0.469 (11.91)	0.563 (14.30)	7566K4	7566K5	7566K7	—
	2PDT	ON	OFF	MOM. ON	D	0.469 (11.91)	0.563 (14.30)	7568K3 ①	7568K2 ①	7568K4 ①	—
		MOM. ON	OFF	MOM. ON	D			7569K1	7569K2	7569K3	—
		ON	NONE	MOM. ON	D			7570K4	7570K5	7570K7	—
2PDT	MOM. ON	OFF	MOM. ON	D	0.469 (11.91)	0.688 (17.48)	7569K38	7569K36	7569K40	—	
20A, 125 Vac 10A, 250 Vac 3/4 hp, 250 Vac 1/2 hp, 125 Vac	2PST	ON	NONE	OFF	C	0.469 (11.91)	0.688 (17.48)	7630K38	7630K36	7630K40	—
	2PDT	ON	NONE	ON	D	0.469 (11.91)	0.688 (17.48)	7632K38	7632K36	7632K40	—
Section A 10A 250 Vac; 15A 125 Vac, 3/4 hp 250 Vac, 4.2A L 125 Vac; Section B 10A 250 Vac, 15A 125 Vac, 1/4 hp 250 Vac	2PDT	OFF	1 ON	2 ON	7571	0.469 (11.91)	0.563 (14.30)	7571K2	7571K4	7571K6	—
20A, 125 Vac 10A, 250 Vac 1 hp, 120–240 Vac	2PST	ON	NONE	OFF	C	0.469 (11.91)	0.688 (17.48)	7803K11	7803K31	7803K21 ②	7803K41
	2PDT	ON	OFF	ON	D	0.469 (11.91)	0.688 (17.48)	7803K12	7803K32	7803K22 ③	7803K42
		ON	NONE	ON	D			7803K13	7803K33	7803K23 ③	7803K43
	MOM. ON	OFF	MOM. ON	D			7803K17 ②	7803K37 ②	7803K27 ②	7803K47 ②	

Notes

- ① Also 1/2 hp at 125–250 Vac Rating.
- ② Not CSA Certified.
- ③ Also 7.5A, 277 Vac, 3/4 hp, 120–240–277 Vac.

4.4

Toggle Switches

General Purpose Toggles—AC Rated

4



AC Rated Toggle Switches—Three-Pole

Rating	Poles and Throw	Circuit with Toggle in ...			Base Circuit See Page V11-T4-35	Bushing Length "A" Inches (mm)	Lever Length "B" Inches (mm)	Catalog Number			
		UP Position	CENTER Position	DOWN Position				Solder Lugs	Screw Terminals	0.250 in Spade Terminals	Combi-Term
15A, 125 Vac 10A, 250 Vac	3PST	ON	NONE	OFF	E	0.469 (11.91)	0.688 (17.48)	7700K1	7700K2	7700K3	—
3/4 hp, 250 Vac	3PDT	ON	OFF	ON	F	0.469 (11.91)	0.688 (17.48)	7701K1	7701K2	7701K3	—
1 hp, 3 Ph 125–600 Vac	ON	ON	NONE	ON				7702K1	7702K2	7702K3	—
1 hp, 1 and 2 Ph 125–480 Vac											
15A, 125 Vac 10A, 250 Vac	3PDT	MOM. ON	OFF	ON	F	0.469 (11.91)	0.688 (17.48)	7704K1	7704K2	7704K3	—
3/4 hp, 250 Vac		MOM. ON	NONE	ON				7705K1	7705K2	7705K3	—
20A, 125 Vac 10A, 250 Vac	3PDT	ON	OFF	ON	F	0.469 (11.91)	0.688 (17.48)	7804K12 ^{②④}	7804K32 ^②	7804K22 ^②	7804K42 ^②
1 hp, 120 Vac 1, 2 and 3 Ph											





AC Rated Toggle Switches—Four-Pole

Rating	Poles and Throw	Circuit with Toggle in ...			Base Circuit See Page V11-T4-35	Bushing Length "A" Inches (mm)	Lever Length "B" Inches (mm)	Catalog Number			
		UP Position	CENTER Position	DOWN Position				Solder Lugs	Screw Terminals	0.250 in Spade Terminals	Combi-Term
15A, 125 Vac 10A, 250 Vac	4PST	ON	NONE	OFF	E	0.469 (11.91)	0.688 (17.48)	7691K14	7690K8	—	—
3/4 hp, 250 Vac	4PDT	ON	OFF	ON	F	0.469 (11.91)	0.688 (17.48)	7693K2	7692K13	—	—
	ON	ON	NONE	ON				7695K5	7694K4	—	—
20A, 125 Vac 10A, 250 Vac	4PST	ON	NONE	OFF	E	0.469 (11.91)	0.688 (17.48)	7933K38	7933K36	7933K40	—
3/4 hp, 250 Vac	4PDT	ON	OFF	ON	F	0.469 (11.91)	0.688 (17.48)	7934K38	7934K36	7934K40	—
1/2 hp, 125 Vac	ON	ON	NONE	ON				7935K38	7935K36	7935K40	—
20A, 125 Vac 10A, 250 Vac	4PDT	ON	OFF	ON	F	0.469 (11.91)	0.688 (17.48)	7805K12 ^②	7805K32 ^②	7805K22 ^②	7805K42 ^②
1 hp, 125–240 Vac 2 and 3 Ph											



Notes

- ① Also 1/2 hp at 125–250 Vac Rating.
- ② Not CSA Certified.
- ③ Also 7.5A, 277 Vac, 3/4 hp, 120–240–277 Vac.
- ④ 1 hp at 240–480 Vac single- or two-phase and 240–600 Vac three-phase.



AC Rated Sealed ① Toggle Switches—Single-Pole

Rating	Poles and Throw	Circuit with Toggle in ...			Base Circuit See Page V11-T4-35	Bushing Length "A" Inches (mm)	Lever Length "B" Inches (mm)	Catalog Number		
		UP Position 	CENTER Position 	DOWN Position (Keyway) 				Solder Lugs	Screw Terminals	0.250 in Spade Terminals
10A, 250 Vac 1/2 hp, 250 Vac	1PST	OFF	NONE	MOM. ON	A	0.469 (11.91)	0.563 (14.30)	—	7506K20	7506K21
	1PDT	MOM. ON ON ON	OFF NONE OFF	MOM. ON MOM. ON MOM. ON	B	0.469 (11.91)	0.563 (14.30)	— — —	7509K20 7510K20 7508K20	7509K21 7510K21 7508K21
15A, 125 Vac 10A, 250 Vac 3/4 hp, 250 Vac 1/2 hp, 125V–250 Vac	1PST	ON	NONE	OFF	A	0.469 (11.91)	0.563 (14.30)	7501K22	7500K20 ②	7501K21
15A, 125 Vac 10A, 250 Vac 1/2 hp, 125 Vac 3/4 hp, 250 Vac	1PDT	ON	OFF	ON	B	0.469 (11.91)	0.563 (14.30)	—	7502K20	7503K21
	1PDT	ON	NONE	ON	B	0.469 (11.91)	0.563 (14.30)	—	7504K20 ②	7505K21

AC Rated Sealed ① Toggle Switches—Two-Pole

Rating	Poles and Throw	Circuit with Toggle in ...			Base Circuit See Page V11-T4-35	Bushing Length "A" Inches (mm)	Lever Length "B" Inches (mm)	Catalog Number		
		UP Position 	CENTER Position 	DOWN Position (Keyway) 				Solder Lugs	Screw Terminals	0.250 in Spade Terminals
15A, 125 Vac 10A, 250 Vac 3/4 hp, 250 Vac 1/2 hp, 125 Vac	2PST	ON	NONE	OFF	C	0.469 (11.91)	0.563 (14.30)	—	7560K20	7561K21
15A, 125 Vac 10A, 250 Vac 3/4 hp, 125–250 Vac	2PDT	ON	OFF	ON	D	0.469 (11.91)	0.563 (14.30)	—	7562K20	7563K21
15A, 125 Vac 10A, 250 Vac 3/4 hp, 250 Vac	2PDT	ON	NONE	ON	D	0.469 (11.91)	0.563 (14.30)	—	7564K20	7565K21
15A, 125 Vac 10A, 250 Vac 1/2 hp, 250 Vac	2PST	OFF	NONE	MOM. ON	C	0.469 (11.91)	0.563 (14.30)	—	7566K20	7566K21
	2PDT	ON	OFF	MOM. ON	D	0.469 (11.91)	0.563 (14.30)	—	7568K20 ②	7568K21 ②
		MOM. ON ON	OFF NONE	MOM. ON MOM. ON	— —	7569K20 7570K20	7569K21 7570K21			

AC Rated Special Circuit Toggle Switches—Two-Pole

Rating	Poles and Throw	Circuit with Toggle in ...			Base Circuit See Page V11-T4-35	Bushing Length "A" Inches (mm)	Lever Length "B" Inches (mm)	Catalog Number		
		UP Position 	CENTER Position 	DOWN Position (Keyway) 				Solder Lugs	Screw Terminals	0.250 in Spade Terminals
15A, 125 Vac 10A, 250 Vac 3/4 hp, 125–250 Vac	2PDT	2-3, 5-6	OFF	2-6, 5-3	D	0.469 (11.91)	0.563 (14.30)	7563K24	7562K23	7563K25
15A, 125 Vac 10A, 250 Vac 3/4 hp, 250 Vac	2PDT	2-3, 5-6	NONE	2-6, 5-3	D	0.469 (11.91)	0.563 (14.30)	7565K24	7564K23	7565K25

Notes

- ① Seal is lever seal only and is dust and splash resistant. Panel seal is available, Part Number 32-341.
- ② Also 1/2 hp at 125–250 Vac Rating.

Technical Data and Specifications

General Purpose Toggles—AC Rated

Description	Specification
Ratings	See Product Selection tables; Switch ratings at 125 Vac also apply to 28 Vdc
Contact mechanism	Slow-make/slow-brake butt contact
Terminal types	Screw terminals—brass designed to accept #6-32x 3/16 binding head (Cat. No. 811-2) screws Furnished unassembled Solder lug terminals—tintillate-plated brass Spade terminals—combi-term—brass
Base material	Thermoset molding material
Mounting means	Threaded bushing—0.468 in (11.89 mm) dia., 32 threads/in Keyway—0.068 x 0.035 in (1.73 x 0.89 mm) deep, provides anti-rotation feature Hardware supplied—1 hexagon locknut (Cat. No. 15-192) and 1 bright nickel-plated knurled facenut (Cat. No. 15-124F1), except 7700–7705, which have bright nickel hexagon facenut (Cat. No. 15-966-2) Furnished unassembled
Finish	Bright nickel-plated toggle lever and bushing
Dielectric withstand	1000V rms minimum
Operating temperature range	0° to 150°F (–17.8° to 65.6°C)

Contact Material

Ampere	Movable	Stationary
7500, 7600, 7700 and 7900 Series Switches		
3 to 6	Silver-plated copper	Silver-plated copper
10 to 20	Silver-plated copper with silver buttons	Silver-plated copper with silver buttons
20 to 30	Silver-plated copper with cad oxide buttons	Copper with cad oxide buttons
7800 Series Switches		
3 to 6	Silver-plated copper	Silver-plated copper
10 to 20	Copper with silver buttons	Copper with silver buttons

Dimensions

Approximate Dimensions in Inches (mm)

7500, 7600, 7700 and 7900 Series

1PST Maintained and Momentary (Screw Terminals)

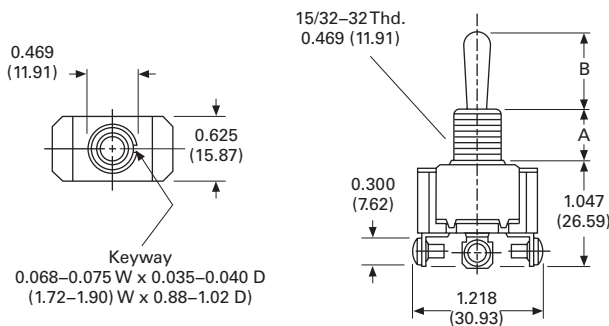

1PDT Maintained and Momentary (Spade Terminals)

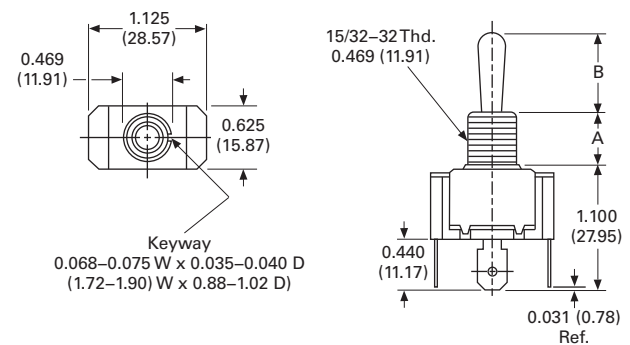

Approximate Dimensions in Inches (mm)

7500, 7600, 7700 and 7900 Series, continued

2PDT Maintained (Solder Lugs)

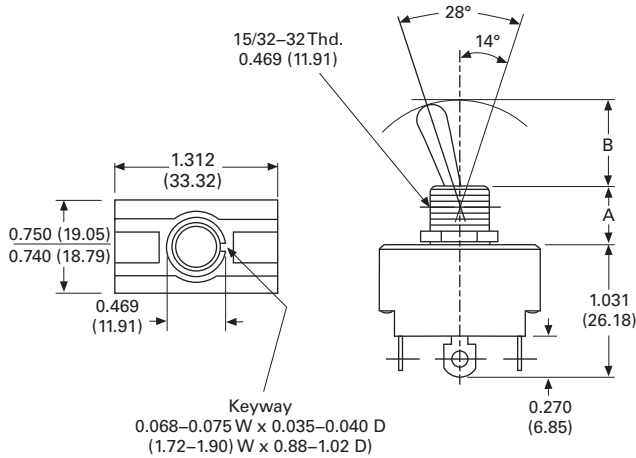

2PDT Maintained (Spade Terminals)

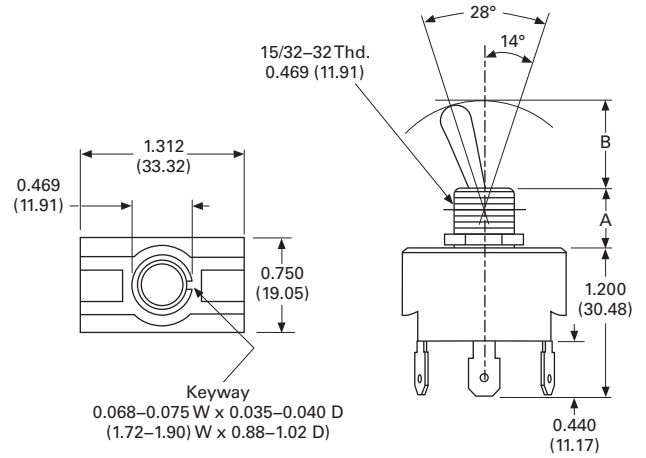

1PDT Maintained and Momentary (Solder Lugs)

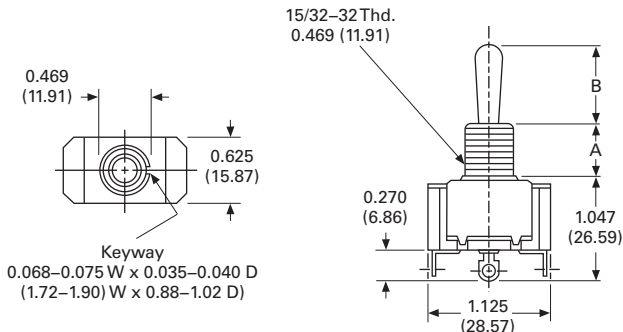

2PDT Momentary (Screw Terminals)

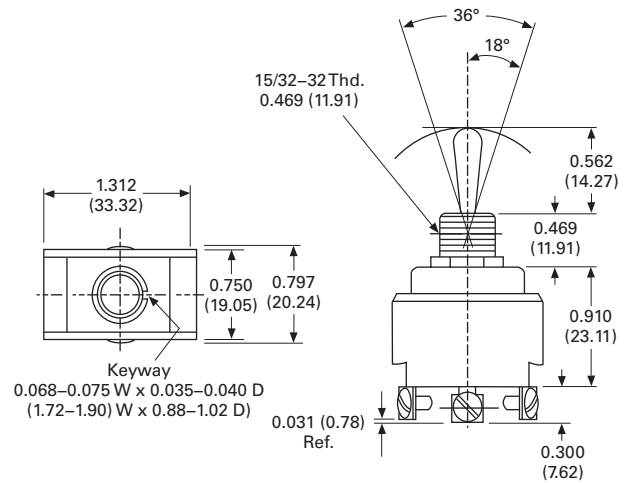

2PDT Maintained (Screw Terminals)

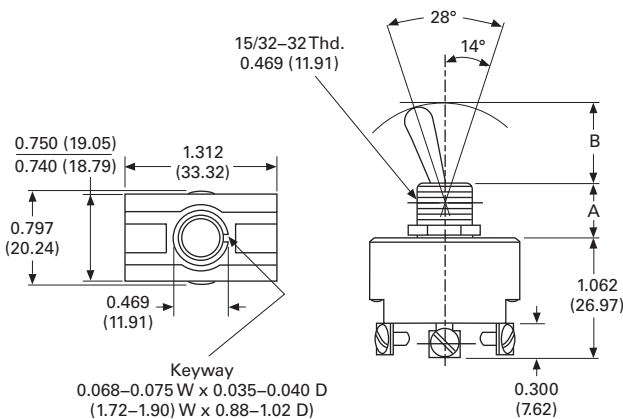

2PDT Momentary (Spade Terminals)

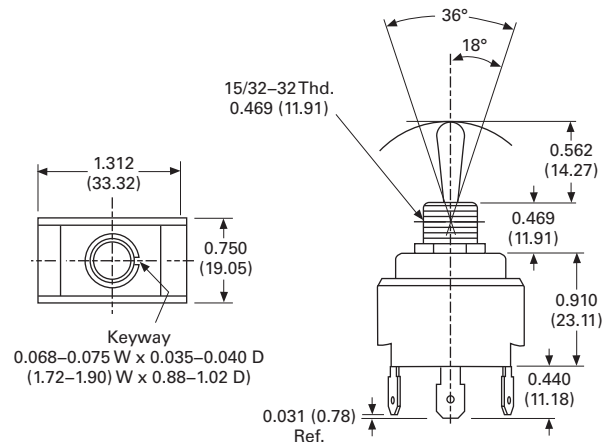

4.4

Toggle Switches

General Purpose Toggles—AC Rated

Approximate Dimensions in Inches (mm)

7500, 7600, 7700 and 7900 Series, continued

3PDT Maintained and Momentary (Solder Lugs)

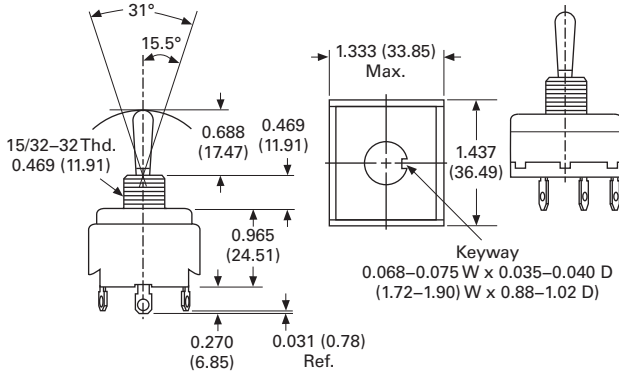

3PDT Maintained and Momentary (Spade Terminals)

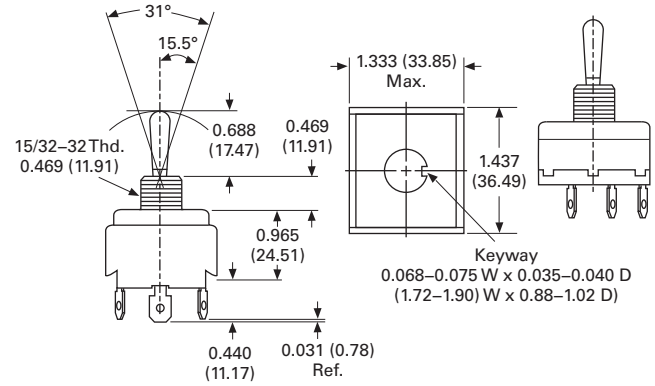

2PDT Momentary (Solder Lugs)

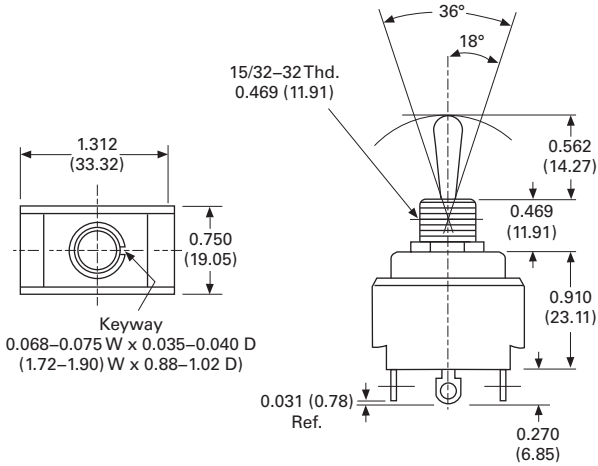

4PDT Maintained and Momentary (Screw Terminals)

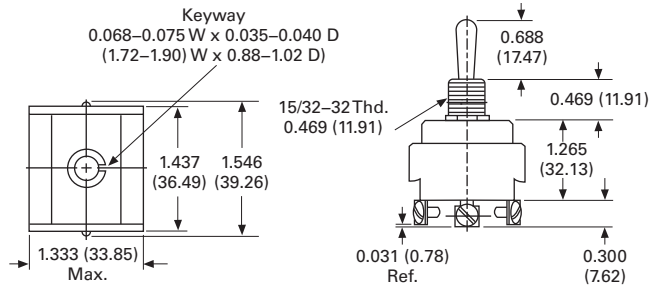

4PDT Maintained and Momentary (Solder Lugs)

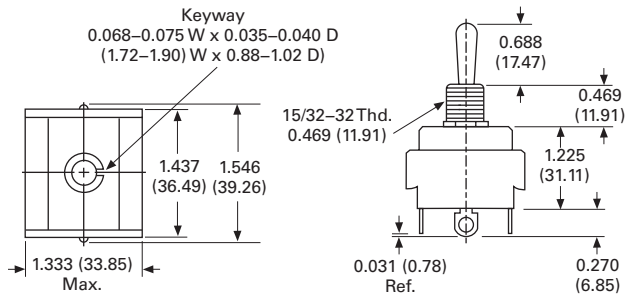

3PDT Maintained and Momentary (Screw Terminals)

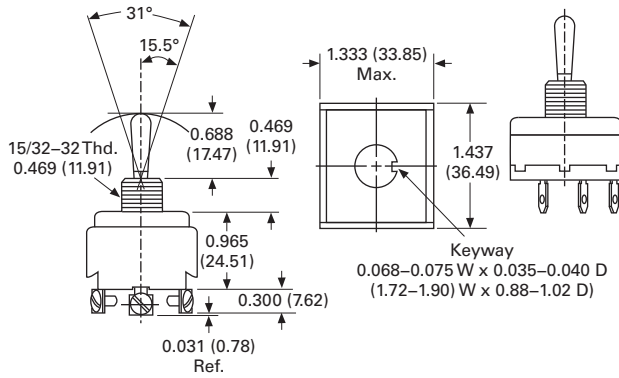

4PDT Maintained and Momentary (Spade Terminals)

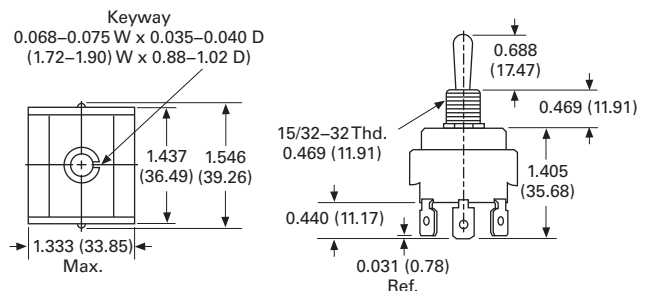

Approximate Dimensions in Inches (mm)

7800 Series

2PDT Maintained (Screw Terminals)

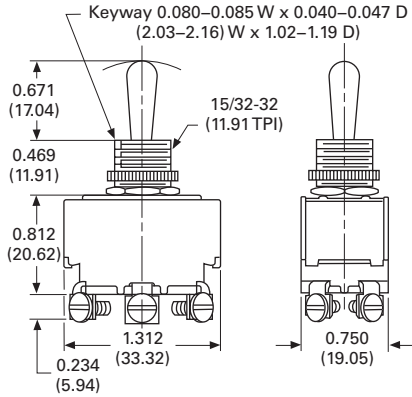

4PDT Maintained (Screw Terminals)

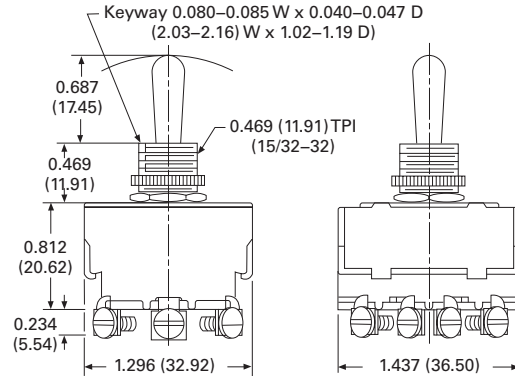

2PDT Maintained (Combi-Terminals)

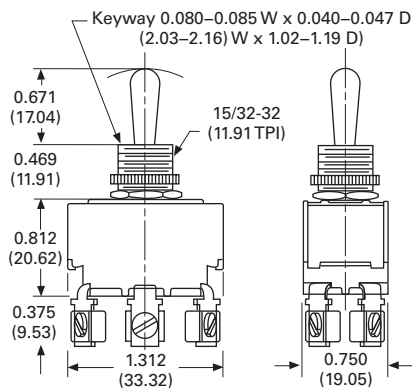

3PDT Maintained (0.25 in Spade Terminals)

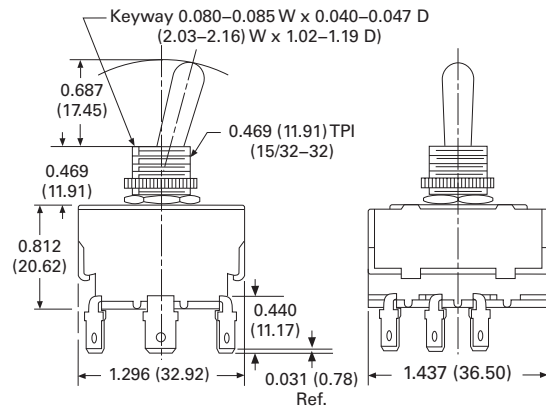

3PDT Maintained (Screw Terminals)

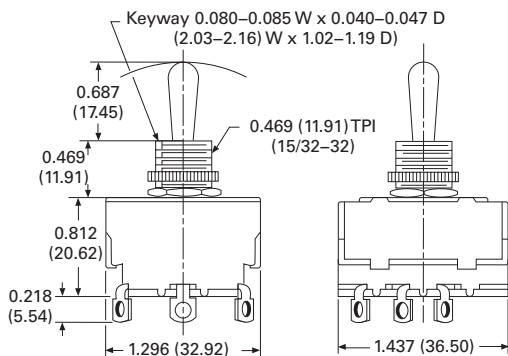

Combi-Term Termination Options

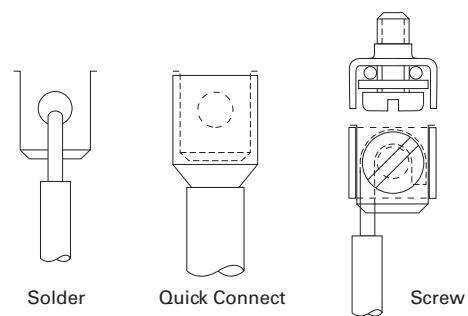

4.5

Toggle Switches

General Purpose Toggles—AC/DC Rated

General Purpose Toggles



Contents

Description

Page

General Purpose Toggles—AC/DC Rated	
Technical Data and Specifications	V11-T4-21
Dimensions	V11-T4-21

Product Description

This line of switches employs a quick-make/quick-break contact mechanism. The resultant high-speed movement eliminates the “teasing” of the switch and reduces the pitting of the

contact surfaces due to arcing. Self-cleaning and wiping contact action assures positive contact on switch operation. These switches are especially suited for use in small motor applications.

Options

- Lever—11/16 in
- Lever seal
- Mounting hardware; furnished assembled
- Other lead lengths

Standards and Certifications

- UL Recognized
- CSA Certified
- RoHS Compliant [Ⓢ]



Note

[Ⓢ] Visit www.eaton.com/vcbu for the most up-to-date list of verified part numbers.

Product Selection

AC/DC Rated Toggle Switches—Single-Pole



Rating	Poles and Throw	Circuit with Toggle in ...			Base Circuit See Page V11-T4-35	Bushing Length “B” Inches (mm)	Lever Length “A” Inches (mm)	Catalog Number		
		UP Position	CENTER Position	DOWN Position				Solder Lugs	Screw Terminals	Wire Leads
3A, 250 Vdc	1PST	ON	NONE	OFF	A	0.344 (8.74)	0.500 (12.70)	8280K115	8295K107	8290K115
6A, 125 Vac/Vdc 3A, 250 Vdc	1PST	ON	NONE	OFF	A	0.344 (8.74)	0.500 (12.70)	8381K107	8396K107	8391K107
		MOM. ON	NONE	OFF				8381K108	8396K108	8391K108
	1PDT	ON	NONE	ON	B	0.469 (11.91)	0.500 (12.70)	8928K479	—	—

AC/DC Rated Toggle Switches—Two-Pole



Rating	Poles and Throw	Circuit with Toggle in ...			Base Circuit See Page V11-T4-35	Bushing Length “B” Inches (mm)	Lever Length “A” Inches (mm)	Catalog Number		
		UP Position	CENTER Position	DOWN Position				Solder Lugs	Screw Terminals	Wire Leads
7A, 125V 3A, 250 Vdc	2PST	ON	NONE	OFF	C	0.469 (11.91)	0.500 (12.70)	8370K107	8372K107	8371K107
		MOM. ON	NONE	OFF				8928K481 [Ⓢ]	8928K482 [Ⓢ]	—
	2PDT	ON	NONE	ON	D	0.344 (8.74)	0.500 (12.70)	8373K108	8375K108	8374K108
		ON	NONE	ON				8373K107	8375K107	8374K107

Note

[Ⓢ] Rating: 6A, 125 Vac/Vdc and 3A, 250 Vdc.

Technical Data and Specifications

General Purpose Toggles—AC/DC Rated

Description	Specification
Ratings	See Product Selection table; Switch ratings at 125 Vac also apply to 28 Vdc
Circuits	1PST, 1PDT, 2PST, 2PDT Maintained and momentary toggle action
Contact mechanism	Quick-make/quick-break wiping action
Contact material	Bronze silver-plated
Terminal types	Screw terminals—brass designed to accept #5-40 x 5/32 in (Cat. No. 11-26) screws Furnished unassembled Solder lug terminals—brass silver-plated with 0.085–0.090 in (2.16–2.29 mm) dia. hole Integrated wire leads—18 gauge, 6 in long and skinned 3/4 in Special wire leads lengths beyond 6 in are available at additional charge
Base material	Thermoset molding material
Mounting means	Threaded bushing—0.468 in (11.89 mm) dia., 32 threads/inch Keyway—0.068 x 0.035 in (1.73 x 0.89 mm) deep, provides anti-rotation feature Hardware supplied—1 hexagon locknut (Cat. No. 15-192) and 1 bright nickel-plated knurled facenut (Cat. No. 15-124F1) Furnished unassembled
Finish	Bright nickel-plated toggle lever and bushing
Operating temperature range	0° to 150°F (–17.8° to 65.6°C)

Dimensions

Approximate Dimensions in Inches (mm)

8280K115
1PST Maintained
(Solder Lug)

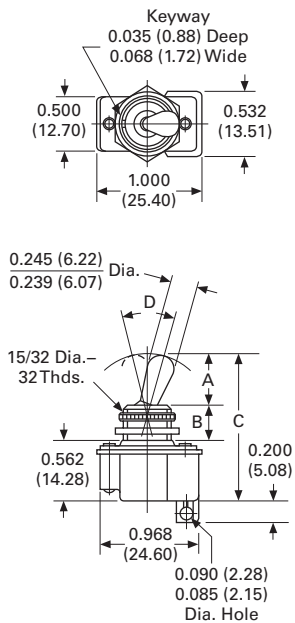

"A" Lever Dim.	"B" Bushing Dim.	"C" Overall Dim.	"D" Throw Dim.
0.500 (12.70)	0.344 (8.74)	1.411 (35.84)	29-1/2°

8290K115
1PST Maintained
(Wire Lead)

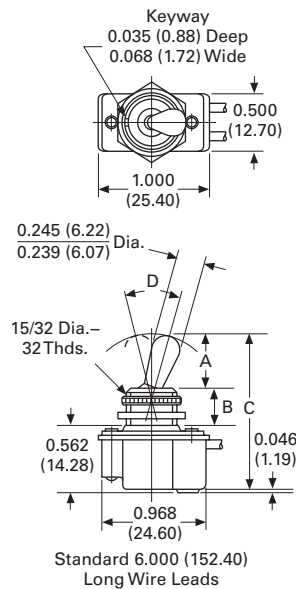

"A" Lever Dim.	"B" Bushing Dim.	"C" Overall Dim.	"D" Throw Dim.
0.500 (12.70)	0.344 (8.74)	1.406 (35.71)	29-1/2°

8295K107
1PST Maintained
(Screw Terminals)

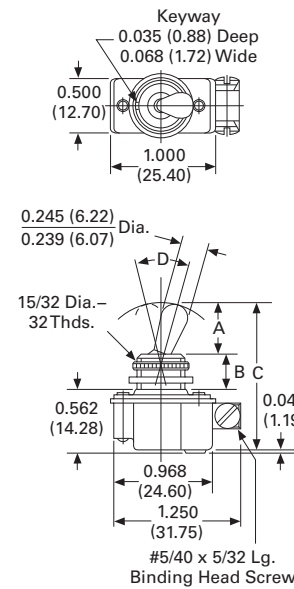

"A" Lever Dim.	"B" Bushing Dim.	"C" Overall Dim.	"D" Throw Dim.
0.500 (12.70)	0.344 (8.74)	1.406 (35.71)	29-1/2°

8381K107 and K108
1PST Maintained
(Solder Lug)

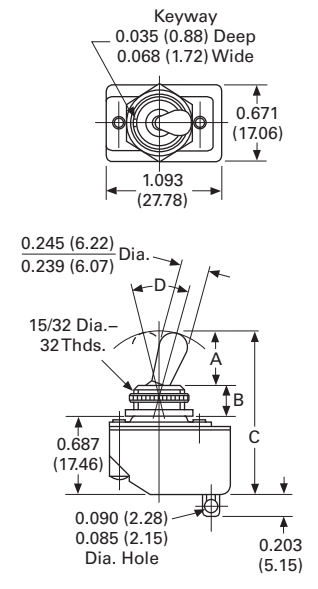

"A" Lever Dim.	"B" Bushing Dim.	"C" Overall Dim.	"D" Throw Dim.
0.500 (12.70)	0.344 (8.74)	1.531 (38.89)	29-1/2°
0.500 (12.70)	0.469 (11.91)	1.656 (42.06)	25-1/2°

4.5

Toggle Switches

General Purpose Toggles—AC/DC Rated

Approximate Dimensions in Inches (mm)

8391K107 and K108
1PST Maintained
(Wire Lead)

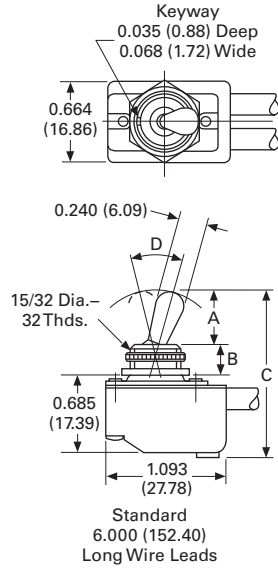

8396K107 and K108
1PST Maintained
(Screw Terminals)

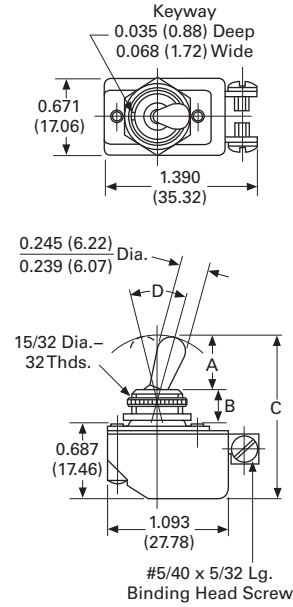

8928K478
1PST Momentary
(Solder Lug)

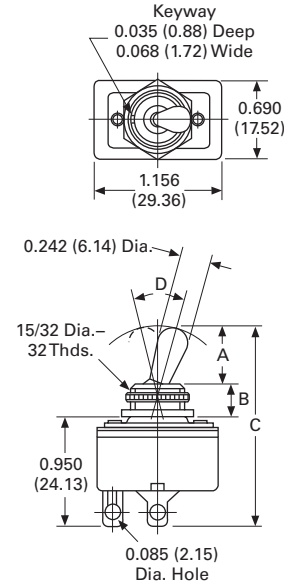

"A" Lever Dim.	"B" Bushing Dim.	"C" Overall Dim.	"D" Throw Dim.
0.500 (12.70)	0.344 (8.74)	1.531 (38.89)	29-1/2°
0.500 (12.70)	0.469 (11.91)	1.656 (42.06)	25-1/2°

"A" Lever Dim.	"B" Bushing Dim.	"C" Overall Dim.	"D" Throw Dim.
0.500 (12.70)	0.344 (8.74)	1.531 (38.89)	29-1/2°
0.500 (12.70)	0.469 (11.91)	1.656 (42.06)	25-1/2°

"A" Lever Dim.	"B" Bushing Dim.	"C" Overall Dim.	"D" Throw Dim.
0.500 (12.70)	0.344 (8.74)	1.980 (50.29)	29-1/2°
0.500 (12.70)	0.469 (11.91)	1.656 (42.06)	25-1/2°

8370 and 8373K107 and K108
2PST/2PDT Maintained
(Solder Lug)

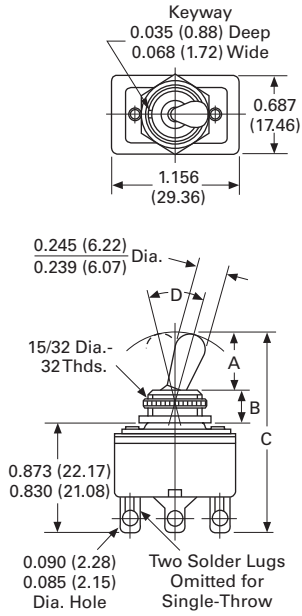

"A" Lever Dim.	"B" Bushing Dim.	"C" Overall Dim.	"D" Throw Dim.
0.500 (12.70)	0.344 (8.74)	1.694 (43.03)	29-1/2°
0.500 (12.70)	0.469 (11.91)	1.820 (46.23)	25-1/2°

8371 and 8374K107 and K108
1PST Maintained
(Wire Lead)

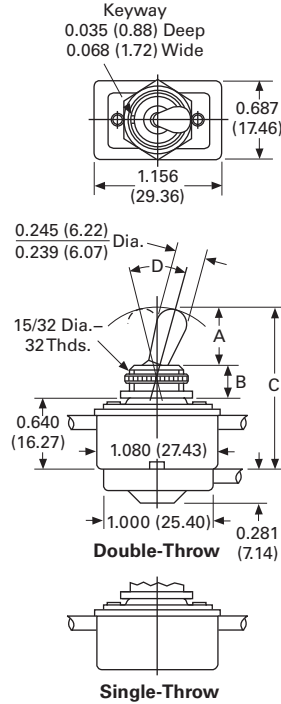

"A" Lever Dim.	"B" Bushing Dim.	"C" Overall Dim.	"D" Throw Dim.
0.500 (12.70)	0.344 (8.74)	1.484 (37.69)	29-1/2°
0.500 (12.70)	0.469 (11.91)	1.515 (38.48)	25-1/2°

8373 and 8375K107 and K108
2PST/2PDT Maintained
(Screw Terminals)

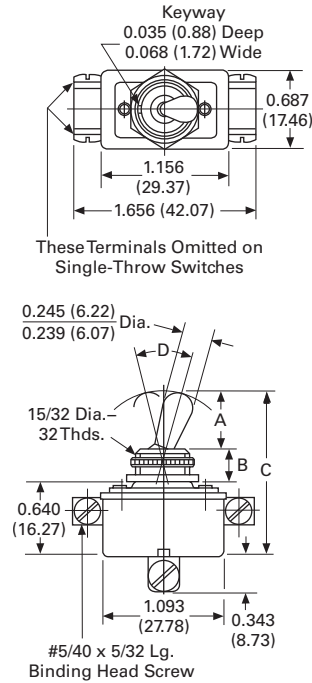

"A" Lever Dim.	"B" Bushing Dim.	"C" Overall Dim.	"D" Throw Dim.
0.500 (12.70)	0.344 (8.74)	1.484 (37.69)	29-1/2°
0.500 (12.70)	0.469 (11.91)	1.609 (40.87)	25-1/2°

X Series Toggles



Product Description

Eaton’s new, competitively priced, AC rated X Series toggles offer a standard high rating for both single- and two-pole applications. The new X Series toggle line offers a wide range of switching circuits, functions and accessories. Ratings for single- and two-pole include 20A at 125 Vac and 10A at 277 Vac to handle more severe inductive, motor and lamp loads.

In addition, X Series toggles have a high standard horsepower rating of 1-1/2 hp, 125–250 Vac for two-pole applications.

The easy-to-install toggles also have an industry-standard 0.48 in diameter mounting hole. For added convenience and delivery support, select industry-standard switch circuit part numbers are available from stock. With so many features, X Series toggles can be used in a variety of applications.

Contents

Description	Page
X Series Toggles	
Product Selection	V11-T4-25
Accessories	V11-T4-25
Technical Data and Specifications	V11-T4-25
Dimensions	V11-T4-26

Application Description

- Commercial and industrial equipment
- Household appliances
- Industrial machinery and automation
- Medical equipment
- Military communications and surveillance
- Rail systems
- Signaling and communications
- Test and lab equipment
- Telecommunications, cable and broadcasting

Standards and Certifications

- UL Recognized component for Canada File E2702
- RoHS Compliant ①



Note

① Visit www.eaton.com/vcbu for the most up-to-date list of verified part numbers.

Product Selection

Single-Pole ^①



Circuit with Toggle in ...

Poles and Throw	Circuit with Toggle in ...			Terminal Type—Catalog Number		
	UP Position	CENTER Position	DOWN Position ^②	0.250 in Spade	Screw	Solder Lugs
1PST	ON	NONE	OFF	XTD1A1A2	XTD1A2A2	XTD1A3A2
1PST	ON ^③	NONE	OFF	XTD1F1A2	XTD1F2A2	XTD1F3A2
1PDT	ON	OFF	ON	XTD2B1A	XTD2B2A	XTD2B3A
1PDT	ON	NONE	ON	XTD2C1A	XTD2C2A	XTD2C3A
1PDT	ON	NONE	ON ^③	XTD2D1A	XTD2D2A	XTD2D3A
1PDT	ON ^③	OFF	ON ^③	XTD2E1A	XTD2E2A	XTD2E3A
1PDT	ON	OFF	ON ^③	XTD2G1A	XTD2G2A	XTD2G3A

Two-Pole ^④



Circuit with Toggle in ...

Poles and Throw	Circuit with Toggle in ...			Terminal Type—Catalog Number		
	UP Position	CENTER Position	DOWN Position ^②	0.250 in Spade	Screw	Solder Lugs
2PST	ON	NONE	OFF	XTD3A1A2	XTD3A2A2	XTD3A3A2
2PST	ON ^③	NONE	OFF	XTD3F1A2	XTD3F2A2	XTD3F3A2
2PDT	ON	OFF	ON	XTD4B1A	XTD4B2A	XTD4B3A
2PDT	ON	NONE	ON	XTD4C1A	XTD4C2A	XTD4C3A
2PDT	ON	NONE	ON ^③	XTD4D1A	XTD4D2A	XTD4D3A
2PDT	ON ^③	OFF	ON ^③	XTD4E1A	XTD4E2A	XTD4E3A
2PDT	ON	OFF	ON ^③	XTD4G1A	XTD4G2A	XTD4G3A

Notes

- ① Ratings: 20A at 125 Vac, 10A at 277 Vac, 3/4 hp, 125–250 Vac; recommended up to 15A at 28 Vdc.
- ② Keyway position.
- ③ Indicates momentary position.
- ④ Ratings: 20A at 125 Vac, 10A at 277 Vac, 1-1/2 hp, 125–250 Vac; recommended up to 15A at 28 Vdc.

Accessories

See Accessories on [Page V11-T4-31](#).

Technical Data and Specifications

X Series Toggles

Description	Specification
Single-pole rating	20A, 125 Vac; 10A, 277 Vac; 3/4 hp 125–250 Vac; Recommended up to 15A at 28Vdc
Two-pole rating	20A, 125 Vac; 10A, 277 Vac; 1-1/2 hp 125–250 Vac; Recommended up to 15A at 28Vdc
Available circuits	1PST, 1PDT, 2PST, 2PDT
Terminal types	Brass screw, brass solder lugs, brass nickel-plated 0.250 in spade
Hardware included	Zinc nickel-plated knurl nut, zinc nickel-plated hex nut
Mounting means	Threaded bushing 12.0 +0.1, –0 mm; 16.5 +1, –1 mm
Keyway	1.8 mm located in DOWN position
Base material	Thermoset molding material
Finish	Bright nickel-plated toggle lever and bushing
Contact mechanism	Slow-make/slow-break butt contact
Contact resistance	50 ohm maximum
Dielectric strength	AC 1500V, 1 minute
Operating temperature	32° to 149°F (0° to 65°C)
Insulation resistance	DC 500V 100M ohm minute
Seal level rating	IP40
Packaging	Sealed in polybag labeled with part number

4.6

Toggle Switches

X Series Toggles

Dimensions

Approximate Dimensions in Inches (mm)

Single-Pole

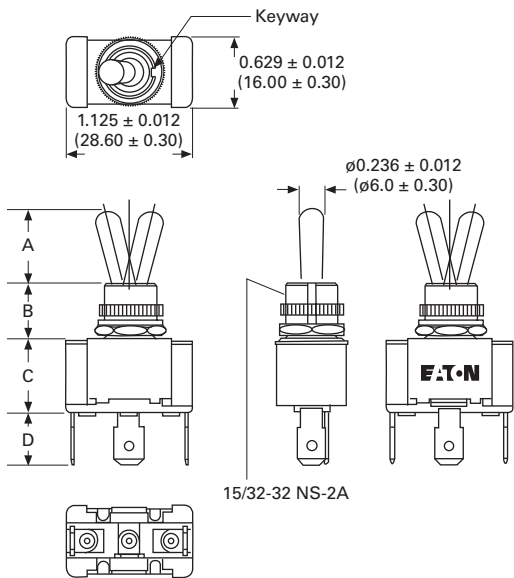

- A** 0.649 ± 0.039
(16.50 ± 1.00)
- B** 0.468 ± 0.012
(11.90 ± 0.30)
- C** 0.677 ± 0.019
(17.20 ± 0.50)
- D** 0.452 ± 0.019
(11.50 ± 0.50)

Two-Pole

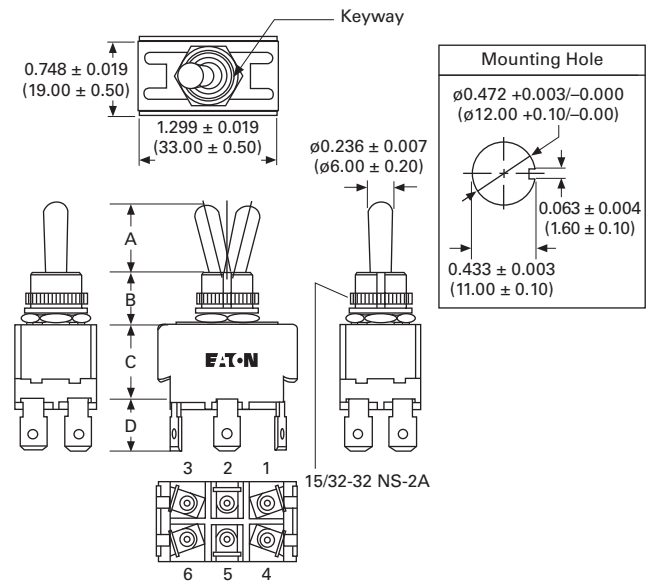

- A** 0.649 ± 0.039
(16.50 ± 1.00)
- B** 0.468 ± 0.012
(11.90 ± 0.30)
- C** 0.740 ± 0.019
(18.80 ± 0.50)
- D** 0.452 ± 0.019
(11.50 ± 0.50)

Heavy Duty Hesitation Switches

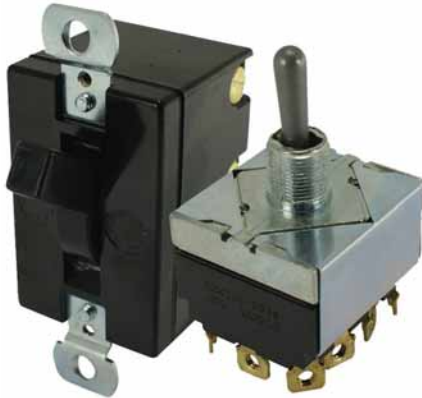

Contents

Description

	<i>Page</i>
Heavy Duty Hesitation Switches	
Product Selection	V11-T4-28
Technical Data and Specifications	V11-T4-29
Dimensions	V11-T4-29

Product Description

One-Hole Panel Mount

These heavy duty toggle switches are available in either two- or three-position. The three-position switches offer a unique positive center stop feature, which assures that the lever cannot be thrown from one side through the center OFF position without stopping. This design feature is a major factor in their widespread acceptance for motor reversing and speed control applications.

The most common application for the switch is to help prevent motor damage resulting from the high current generation by counter EMF of the armature at the time of reversing. This type of device is referred to within the industry as an anti-plugging, hesitation, positive stop or positive off switch. Typical applications include bench tools, coach and truck (electric lift) and X-ray equipment.

Flush Mount

These three-position switches also offer the positive center stop feature where the lever cannot be thrown from one side through the center OFF position without stopping. The high ratings of this series allow it to be used with a broad range of heavy duty applications. Copper contacts and brass screw terminals are standard.

Standards and Certifications

- UL Recognized (except where noted)
- CSA Certified (where noted)





Product Selection

4





Heavy Duty Hesitation Switches—One-Hole Panel Mount

Rating	Poles and Throw ^②	Circuit with Toggle in ...			Base Circuit See Page V11-T4-35	Bushing Length "A" Inches (mm)	Lever Length "B" Inches (mm)	Lever Type	Catalog Number		
		UP Position 	CENTER Position 	DOWN Position (Keyway) 					Solder Terminals	Screw Lugs	0.250 in Spade Terminals
15A, 125 Vac ^① 10A, 250 Vac 3/4 hp, 250 Vac	2PDT	ON	OFF	ON	D	0.468 (11.89)	0.687 (17.45)	Bat	7992K11	7992K10	7992K12
15A, 125 Vac ^① 10A, 250 Vac 3/4 hp, 250 Vac	3PDT	ON	OFF	ON	F	0.468 (11.89)	0.687 (17.45)	Bat	7991K11	7991K10	7991K12
15A, 125 Vac ^① 10A, 250 Vac 3/4 hp, 250 Vac	4PDT	ON	OFF	ON	F	0.468 (11.89)	0.687 (17.45)	Bat	7990K11	7990K10	7990K12



Heavy Duty Hesitation Switches—Flush Mount

Rating	Poles and Throw	Circuit with Toggle in ...			Lever Type	Termination Type	Catalog Number
		UP Position 	CENTER Position 	DOWN Position (Keyway) 			
20A, 125 Vac/Vdc 10A, 250 Vac/Vdc	2PDT	ON	NONE	ON	Square	Screw	7810K1 7810K2 ^{③④}
30A, 125 Vac/Vdc 20A, 250 Vac/Vdc	2PDT	ON	OFF	ON	Square	Screw	7811K5 ^{③⑤}
	3PDT	ON	OFF	ON	Square	Screw	7812K2
	4PDT	ON	OFF	ON	Square	Screw	7813K2

Notes

- ① Listed rating for 125 Vac also applies at 28 Vdc.
- ② Supplied in a four-pole base.
- ③ CSA Certified.
- ④ Also rated 5A, 600 Vac; 1-1/2 hp, 250 Vdc; 2 hp, 240 Vac.
- ⑤ Also rated 2 hp, 250 Vac/Vdc.

Technical Data and Specifications

Heavy Duty Hesitation Switches

Description	Specification
Ratings	See Product Selection tables; Switch ratings at 125 Vac also apply to 28 Vdc
Circuits	2PDT, 3PDT, 4PDT; maintained action
Contact mechanism	
One-hole panel mount	AC rated devices—slow-make/Slow-break butt contact AC/DC rated devices—Quick-make/quick-break wiping contacts
Flush mount	Quick-make/quick-break wiping contacts
Contact material	
One-hole panel mount	AC rated devices: Movable—silver-plated copper with fine or coin silver contact face button Stationary—copper with fine or coin silver contact face button AC/DC rated devices: Movable—copper Stationary—bronze
Flush mount	Movable—copper Stationary—copper
Terminal types	Screw terminals—brass
Mounting means	
One-hole panel mount	AC rated devices: Threaded bushing—0.468 in (11.89 mm) dia., 32 threads/in Keyway—0.068 x 0.035 in (1.73 x 0.89 mm) deep, provide anti-rotation feature Hardware supplied— 1 hexagon locknut (Catalog Number 15-192) and 1 hex facenet (Catalog Number 15-966-6) Furnished unassembled
Flush mount	Flush mounting panel tabs
Dielectric withstand	1000V rms minimum
Operating temperature range	0° to 150°F (–17.8° to 65.6°C)

Dimensions

Approximate Dimensions in Inches (mm)

One-Hole Panel Mount

7990K10—4PDT

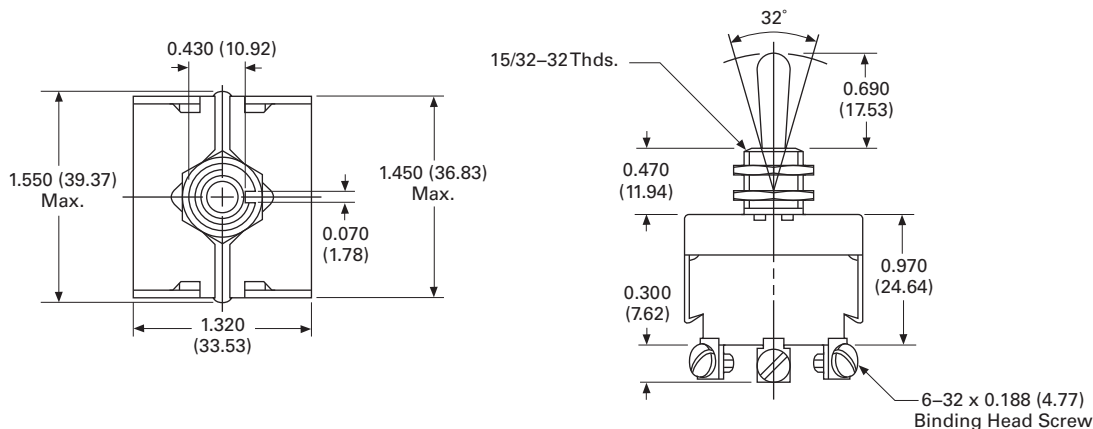

4.7

Toggle Switches

Heavy Duty Hesitation Switches

Approximate Dimensions in Inches (mm)

Flush Mount

7810K2-2PDT

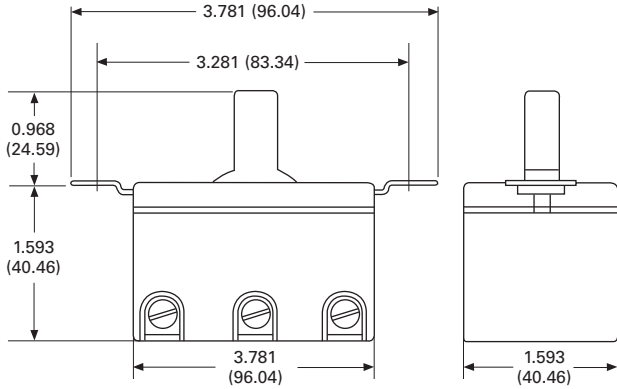

7811K2-2PDT

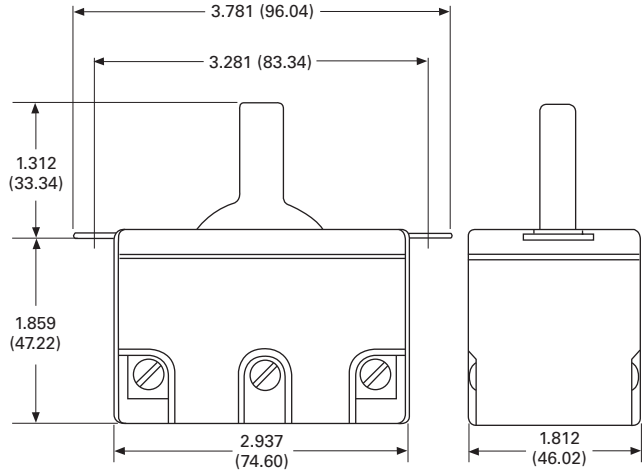

7813K2-4PDT

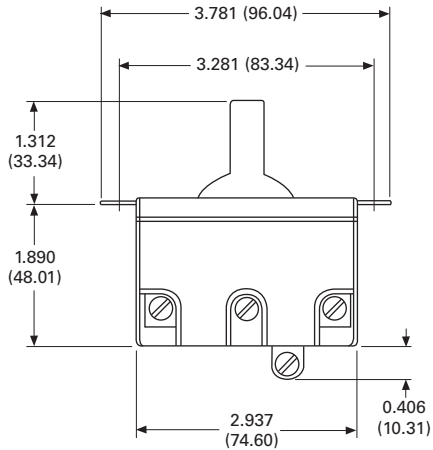

Mounting Hardware

Product Description

One-Hole Mounting Switches

All bushing mounted switches are furnished with two mounting nuts. One nut is mounted behind the panel to prevent the bushing sleeve from being distorted if the front panel is overtightened

Eaton accepts no responsibility for damage to switches mounted without the backup nuts.

Product Selection

Mounting Hardware for One-Hole Mounting Switches—Mounting Nuts ^①

Size	Description	Material	Thickness Dim. "A" in Inches (mm)	Inside Diameter Dim "B" in Inches (mm)	OD or Dimension Across Flats Dim. "C" in Inches (mm)	Dimension Across Corners Dim. "D" in Inches (mm)	Catalog Number
3/8-27	Hexagon locknut	Nickel-plated brass	0.125 (3.18)	—	0.562 (14.27)	0.625 (15.88)	15-2526-2
3/8-24		Bright nickel-plated brass		—			15-1525-6
11/32-32		Nickel-plated brass	0.063 (1.60)	—	0.473 (12.01)	0.531 (13.49)	15-1525-2
15/32-32	Hexagon locknut	Zinc-chromate treated	0.075 (1.91)	—	0.625 (15.88)	—	15-192
		Bright nickel-plated brass	0.078 (1.98)	—	0.546 (13.87)	0.625 (15.88)	15-2525-58
		Zinc-chromate treated	0.188 (4.76)	0.783 (19.89)	1.125 (28.80)	—	15-2528-2
	Hexagon facenut	Nickel-plated brass	0.078 (1.98)	—	0.562 (14.27)	0.656 (16.66)	15-966-2
		Semi-lustre nickel-plated brass		—			19-966-6
	Knurled facenut	Bright nickel-plated brass	0.066 (1.68)	—	0.562 (14.27)	—	15-124F1
		Black cupric oxide-plated brass		—		—	15-124F5
		Brass nickel-plated brass	0.109 (2.77)	—	0.625 (15.88)	—	15-90
	Chamfered dress nut	Bright nickel-plated brass	0.151 (3.84)	0.312 (7.92)	0.687 (17.45)	—	15-994-2
	Standard knurl nut with shoulder	Nickel-plated brass	0.109 (2.77)	—	0.593 (15.06)	—	15-2534-14
	Dress nut	Satin chrome-plated brass	0.125 (3.18)	—	0.562 (14.27)	—	15-2523-4
		Black nylon	0.187 (4.75)	0.390 (9.91)	0.640 (16.26)	—	15-1048-3
	Knurled dress nut	Chrome-plated brass	0.187 (4.75)	0.312 (7.92)	0.640 (16.26)	—	15-189-5
3/4-32	Hexagon facenut	Nickel-plated steel	0.093 (2.36)	—	0.937 (23.80)	1.078 (27.38)	15-1043
#8-40	Hexagon locknut with facenut	Nickel-plated steel	0.060 (1.52)	—	0.245 (6.22)	0.216 (5.49)	15-1047

Note

^① Hardware items are sold for use with Eaton switches only. Minimum ordering quantity on all items is 100.

Mounting Washers and Locking Ring ①

Approximate Dimensions in Inches (mm)

Size	Description	Material	Thickness Dim. "A"	Inside Diameter Dim "B"	OD or Dimension Across Flats Dim. "C"	Dimension Across Corners Dim. "D"	Catalog Number
For 15/32 bushing	Locking ring	Zinc-plated steel	0.040 (1.02)	0.475 (12.07)	0.718 (18.24)	—	29-761-5

4

Dimensions

Approximate Dimensions in Inches (mm)

Mounting Hardware

Hexagon Locknuts or Facenuts

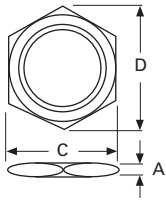

Knurled Facenut

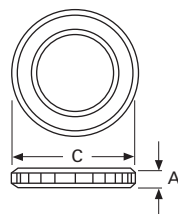

Knurled Nut with Shoulder

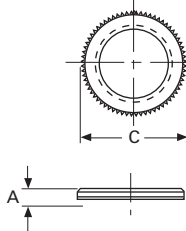

Chamfered Dress Nut
Catalog No. 15-994-2

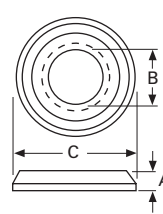

Knurled Dress Nut
Catalog No. 15-189-5

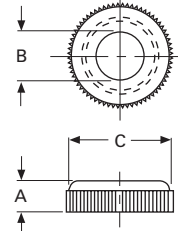

Knurled Dress Nut
Catalog No. 15-1048-3

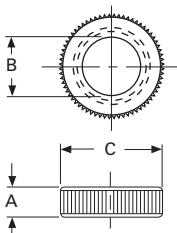

Dress Nut
Catalog No. 15-2523-4

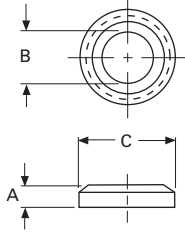

Plain Washer

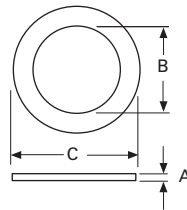

Internal Tooth
Lockwasher

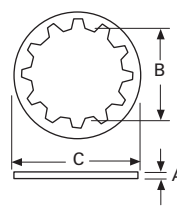

Locking Ring

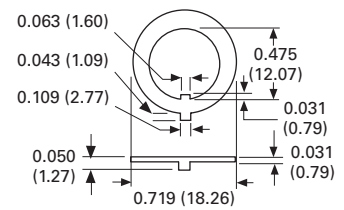

Note

① Hardware items are sold for use with Eaton switches only.

Decorator Facenuts

Product Selection ^①

Type	Color	Catalog Number
Knurled facenuts	Bright black	15-1048-3
	Bright clear	15-1048-7
Beveled facenuts	Bright black	15-1049-3
	Bright clear	15-1049-7

Dimensions

Approximate Dimensions in Inches (mm)

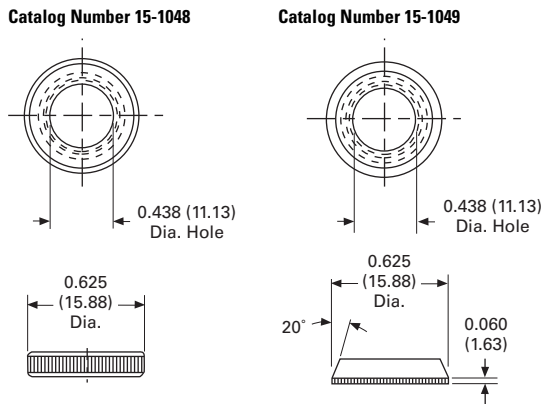

Panel Seal

- Prevents moisture and contaminants from entering panel enclosure
- Behind panel mounting
- Stainless-steel cup washer ensures proper seating of silicone rubber seal
- Seal withstands 20 psi water pressure
- Cat. No. 32-341

Dimensions—32-341

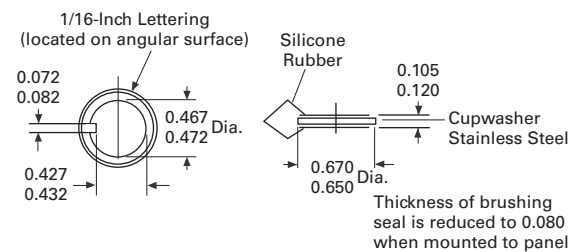

Replacement Terminal Screws

Product Selection

Screw Size	Catalog Number ^②
#5-40 x 1/8 in	11-1117
#5-40 x 5/32 in	11-26
#5-40 x 3/16 in binding head	811-7206
#5-40 x 1/4 in binding head	811-14
#6-32 x 3/16 in binding head	811-2
#6-32 x 1/4 in binding head	811-161
#6-32 x 1/4 in binding head	811-7248
#6-32 x 1/4 in pan head, brass	11-1893
#6-32 x 3/8 in binding head	811-129
#8-32 x 3/16 in binding head	11-1618
#8-32 x 1/4 in	11-1369
#8-32 x 1/4 in	811-408-2
#8-32 x 3/8 in binding head	11-1766
#8-32 x 3/8 in binding head	11-6074-4
#6-32 x 7/32 in binding head	11-6085-2

Toggle Boot

- Prevents moisture and contaminants from entering lever to bushing enclosure
- Front panel mounting
- Threaded mounting nut ensures proper assembly of silicon rubber boot
- Brass nut: 15/32-32 NS-2A
- Black color

Product Selection

SW1RY3030	Mounting Description	Color	Catalog Number
	Front panel mounting Molded in brass mounting nut (15/32-32 NS-2A) ensures proper assembly of silicon rubber boot	Black	SW1RY3030

Dimensions—15/32-32 NS-2A

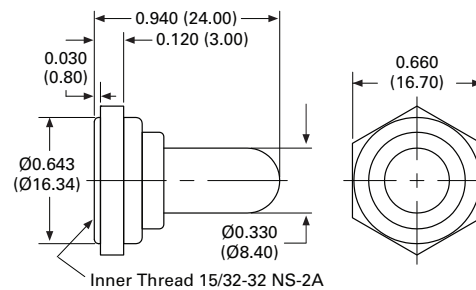

Notes

- ① Decorator facenuts for 15/32 in bushing switches, 15/32-32 thread.
- ② Hardware items are sold for use with Eaton switches only.

Indicating Plates

Product Selection—Indicating Plates for 15/32-Inch Bushing Mounted Switches

4



Keyway Location	Marking Opposite Keyway	Keyway Side	Material	Finish	Catalog Number	
Keyway on bottom	ON	OFF	0.032 in steel	Plain	30-5632	
				Statuary bronze	30-5632-3	
				Burnished nickel	30-5632-4	
	RAD	PHO	0.032 in steel	0.032 in brass	Black cupric oxide ^①	30-2899-3
				Statuary bronze	30-5632-7	
	RUN	START	0.032 in steel	Burnished nickel	30-5632-11	
					30-5632-15	
	HOT	COLD			30-5632-16	
					30-5632-17	
	HI	LOW			30-5632-17	
					30-5632-17	
	FOR	REV	0.032 in steel	Burnished nickel	30-2899-2	
	AUTO	TEST			30-2899-6	
PUSH	START			30-2899-7		
RUN	TEST			30-2899-9		
BLANK	BLANK	0.032 in steel	Burnished nickel	30-5632-8		
Keyway on side	ON	OFF	0.032 in steel	Burnished nickel	30-5632-13	
	OFF	ON			30-2899-8	
Keyway on top	T	B	0.032 in steel	Burnished nickel	30-5632-12	
	OFF	ON			30-5632-14	
	SET	RUN			30-2899-10	
	BLANK	RESET			30-2899-12	
Keyway on top	O	I	0.032 in steel	Burnished nickel	30-5632-23	
	I	O			30-5632-19	



Dimensions

Approximate Dimensions in Inches

Indicating Plate

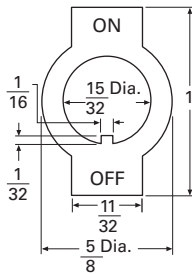

Note

^① White lettering.

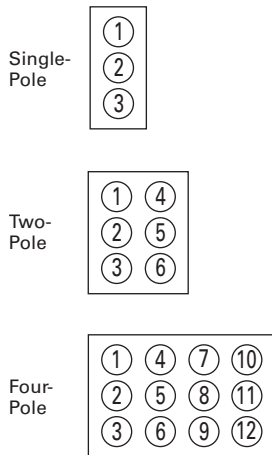

Terminal Identification

When specified on order, switches will have the terminals identified as shown in the illustration at right. Terminal markings will be ink-stamped on the side of the switch case and unused terminal positions will not be identified.

All views are rear of switch with keyway or at down as applicable. Terminal numbers 2, 2 and 5 and 5 and 8 are considered inboard terminals for single-, two- and four-pole switches respectively. All others are considered outboard.

“Three Independent” ON-ON-ON Circuit Diagram

For switch modified with “Three Independent” ON-ON-ON special circuit. External jumpers are required. User to connect wiring per instructions given below.

ON-ON-ON Special Circuit

Connection Points	Single-Pole
Connect common to terminals	2
Connect circuit “A” to terminals	6
Connect circuit “B” to terminals	4
Connect circuit “C” to terminals	1

3 ON Independent	No. of Poles	Circuit with Lever in ...		
		UP Position	CENTER Position (Maintained)	DOWN Position (Keyway)
		Circuit A	Circuit B	Circuit C
1 PDT	1			

Circuit Diagrams

Special General Purpose Toggle Circuits

Circuit Number	Schematic
7530	
7571	
7555	

Toggle Circuit Diagrams

Circuit Letter	Schematic	Circuit Letter	Schematic
A 1PST		I 2 Circuit ⑤	
B 1PDT		J 1PST	
C 2PST		K 1PDT	
D 2PDT		L 2PST	
E 4PST ①		M 2PST	
F 4PDT ②		N ⑥ 2PDT	
G ③ 1PST		P 1PDT	
H ④ 1PDT		Q ⑦ 2 Circuit	

Legends

Toggle Switch Legend

Legend	Toggle Switch Type
●	Contact terminal—will make contact with switch lever
○	Isolated terminal—does not make contact with lever
⊙	Center terminal and switch lever
⊗	Bulb
⚡	Momentary contact
•	Denotes mechanical contact portion

Notes

- ① Poles 11 and 12 may be eliminated for three-pole devices.
- ② Poles 10, 11 and 12 may be eliminated for three-pole devices.
- ③ Dependent lamp.
- ④ Independent lamp.
- ⑤ Two circuit—indicates a special type of double-throw switch in which the two circuits being controlled may be independent of each other.
- ⑥ For 206 Series, an additional lamp is available.
- ⑦ Available in 1PDT or 2PDT.

Slide Control



Paddle Control



Rotary Wiper



5.1 Paddle and Slide Controls

Product Description	V11-T5-2
Catalog Number Selection	V11-T5-2
Technical Data and Specifications	V11-T5-3
Dimensions	V11-T5-3

5.2 Rotary Wipers

Product Description	V11-T5-4
Features	V11-T5-4
Options	V11-T5-4
Standards and Certifications	V11-T5-4
Product Selection	V11-T5-4
Technical Data and Specifications	V11-T5-5
Dimensions	V11-T5-6

Paddle and Slide Controls



Contents

Description

Paddle and Slide Controls	Page
Technical Data and Specifications	V11-T5-3
Dimensions	V11-T5-3

Product Description

Eaton’s unique family of dimmer and wiper controls are field proven to be the market’s most dependable controls. Although originally designed for the heavy truck market, applications in various other types of

vehicles exist. Paddle and slide versions are available and both have the look, feel and durability associated with our controls. Bezels and actuators are molded in a soft matte finish. Illuminated and non-illuminated versions are

available. Board-mounted LEDs located behind a laser-etched panel provide illumination. Customized light panel lettering and custom pad printed bezels are also available. Both dimmer and wiper controls are

designed to complement the NGR family of switches.

Note: Specific frame options are available that allow product to mount in NGR gang mount system. Contact your local Eaton Sales Representative.

Catalog Number Selection

How To Order—Paddle and Slide Controls

To determine complete catalog number, start with the appropriate control type and add the appropriate code letters and/or numbers.

Example: **D P 24 5 C A D G**

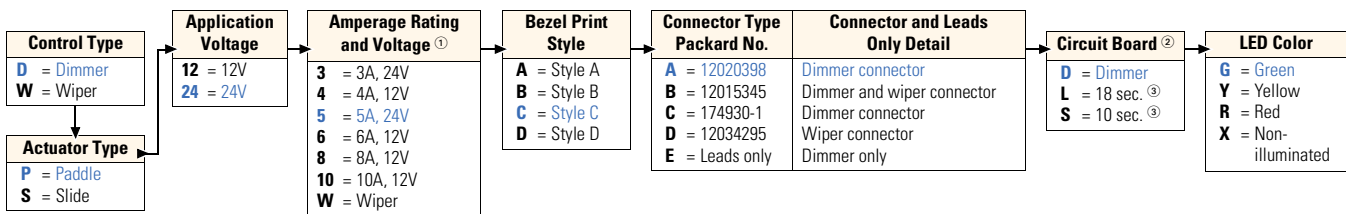

Bezel Print Style ④

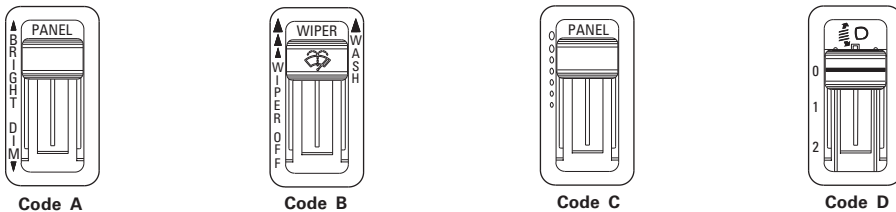

Notes

- ① Amperage ratings for dimmers only.
- ② Maximum dwell time describes the average time constant for delayed wiper activation.
- ③ Maximum nominal dwell.
- ④ Custom pad print available for bezel or button.

Technical Data and Specifications

Paddle and Slide Controls

Description	Specification
Ratings (dimmer only)	4, 6, 8, 10A at 14 Vdc 3, 5A at 28 Vdc
Mechanical life	100,000 operations, maximum
Operating temperature range	-40° to 185°F (-40° to 85°C)
Base material	High-grade thermoplastic molding material
Mounting means	Snap-in mounting with plastic bezel
Mounting hole	Rectangular panel cutout: 1.734 x 0.867 in (44.00 x 22.00 mm)
Panel thickness	
Paddle	0.030 to 0.190 in (0.762 x 4.80 mm)
Slide	0.030 to 0.080 in (0.762 x 2.03 mm)
Approximate weight	1.5 oz

Dimensions

Approximate Dimensions in Inches (mm)

Paddle Control

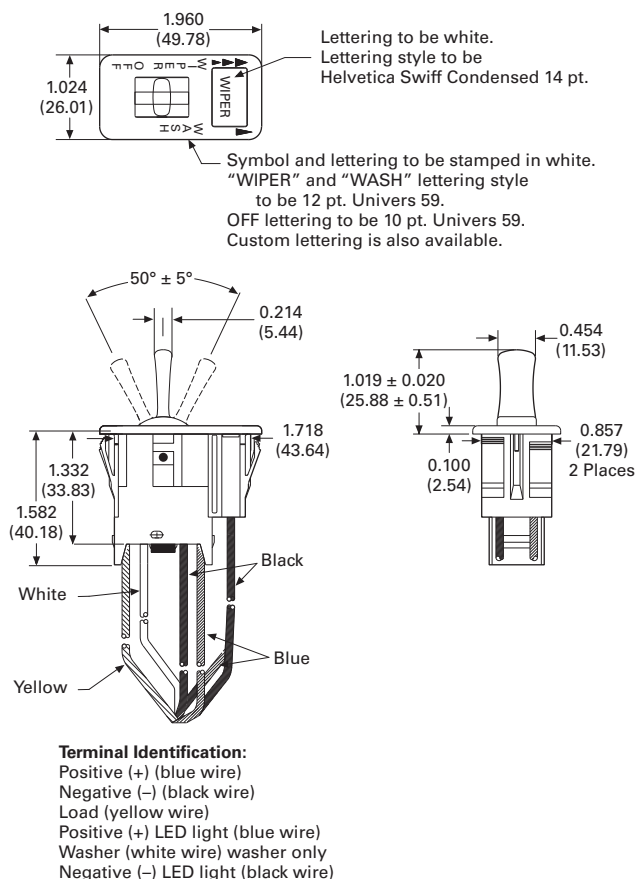

Slide Control

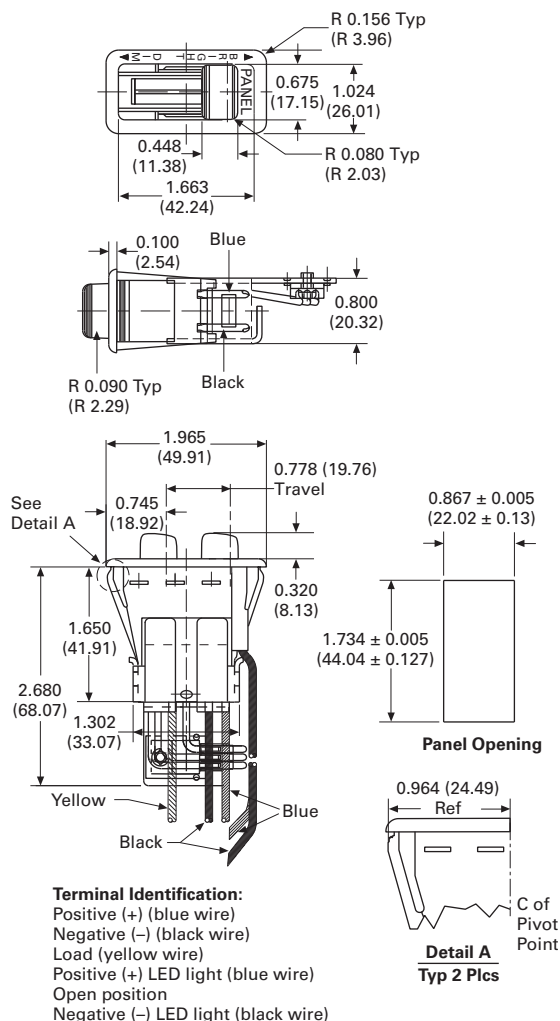

5.2

Dimmers and Wipers

Rotary Wipers

Rotary Wiper



5

Contents

Description

Rotary Wipers

Technical Data and Specifications

Dimensions

Page

V11-T5-5

V11-T5-6

Product Description

The rotary wiper has been designed to be a highly durable rotary wiper control for the transportation industry. The RW200 series wiper has four wiper control

positions via a rotating knob: Off, Intermittent, Continuous Low Speed and Continuous High Speed. The device has a washer function that operates the washer pump and wiper while the knob is depressed.

Features

- Load Dump Protection
 - The switch will withstand a 120V load dump per SAE J1455
- Reverse Voltage Protection
 - The device will not be damaged when exposed to 12 Vdc for 5 minutes

Options

- Variable bushing length
- Variable spindle length
- Choice of connectors
- Pad printing on knob

Standards and Certifications

Meets SAE standards J1455, J1944 and J1988.

Product Selection

To determine complete catalog number, start with the appropriate control type and add the appropriate code letters and/or numbers.

Rotary Wiper Code Numbers and Letters

Series	Code	Voltage	Code	Packard Connectors	Code	Bushing Length in Inches (mm)	Code	Catalog Number
RW	RW	12 Vdc	200	12064752	12A	0.261 (6.63)	A	RW20012AA
						0.424 (10.77)	B	RW20012AB
				12977042	12B	0.261 (6.63)	A	RW20012BA
						0.424 (10.77)	B	RW20012BB
				6288538	12C	0.261 (6.63)	A	RW20012CA
						0.424 (10.77)	B	RW20012CB
				6294544 and 2977048	12D	0.261 (6.63)	A	RW20012DA
						0.424 (10.77)	B	RW20012DB

Technical Data and Specifications

Rotary Wipers

Description	Specification
Operating voltage range	9 Vdc to 16 Vdc
Continuous load rating	17A from -40° to 73°F (-40° to 23°C) Derated to 5A at 185°F (85°C)
Wiper electromechanical life	50,000 cycles
Electrical cycle life	250,000 cycles in the Intermittent position 300,000 cycles combined in the Low and High positions
Operating temperature	-40° to 185°F (-40° to 85°C)
Humidity rating	Device will operate properly at 98% humidity between -40° and 100°F (-40° and 38°C)
Mechanical shock	The switch will withstand a 3 ft drop on concrete
Vibration	The device will operate properly while being exposed to 133 hours of 1G rms vibration along all three axes, sweeping from 5 Hz to 1500 Hz at one octave per minute

Connector Drawings

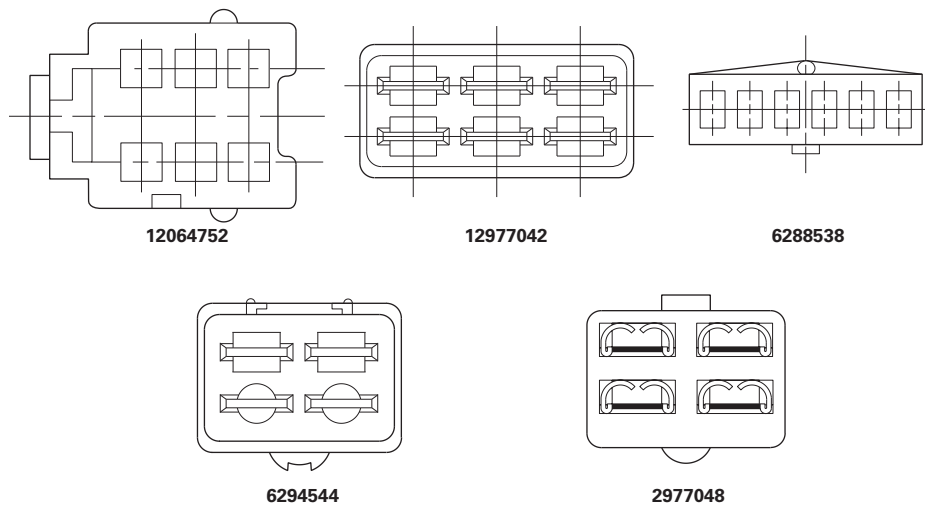

Circuit Continuity

Switch Position	Circuit Continuity
Off	Open
Intermittent	Yellow—Red and brown
Low speed	Yellow
High speed	White
Washer	Brown
	Red—Positive
	Black—Negative

Wire Terminations

Wire Color	Switch Connections
Yellow	Motor low speed terminal
White	Motor high speed terminal
Blue	Motor park terminal
Black	Ground
Brown	Washer pump
Red	+12 Vdc (positive)

5.2

Dimmers and Wipers

Rotary Wipers

Dimensions

Approximate Dimensions in Inches (mm)

RW200 Series

5

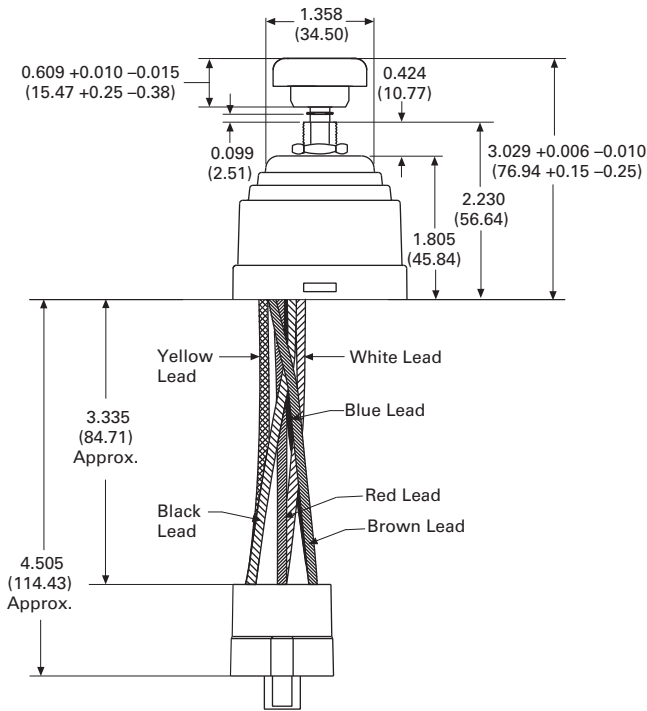
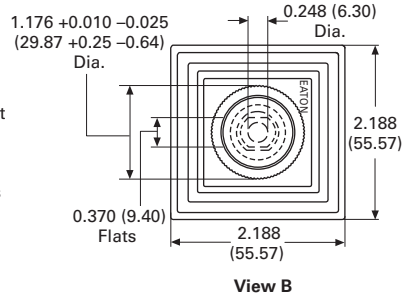
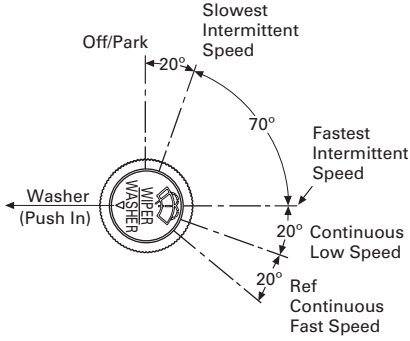

AC Rated Pushbuttons



Illuminated AC/DC Rated Pushbuttons



XP Series Sealed Pushbuttons



6.1 AC Rated

Product Description	V11-T6-2
Features	V11-T6-2
Standards and Certifications	V11-T6-2
Product Selection	V11-T6-3
Technical Data and Specifications	V11-T6-4
Dimensions	V11-T6-5

6.2 Illuminated AC/DC Rated

Product Description	V11-T6-8
Standards and Certifications	V11-T6-8
Product Selection Guide	V11-T6-8
Series 206/208, 220 and 221/224, 231/234	V11-T6-9
Series 580/581/586	V11-T6-10
Series 770/775	V11-T6-11
Series 860 and 861/845, 810/815, 820/825	V11-T6-12
Illuminated and Non-Illuminated Pushbutton Caps	V11-T6-13
Lamp Selection	V11-T6-14
Accessories	V11-T6-16
Technical Data and Specifications	V11-T6-17
Terminal Identification	V11-T6-18
Circuit Diagrams	V11-T6-18
Legends	V11-T6-18
Dimensions	V11-T6-19

6.3 XP Series Sealed Pushbutton

Product Description	V11-T6-21
Application Description	V11-T6-21
Features	V11-T6-21
Standards and Certifications	V11-T6-21
Catalog Number Selection	V11-T6-22
Technical Data and Specifications	V11-T6-22
Dimensions	V11-T6-23

6.1

Pushbuttons

AC Rated

AC Rated



6

Contents

Description

	<i>Page</i>
AC Rated	
Product Selection	V11-T6-3
Technical Data and Specifications	V11-T6-4
Dimensions	V11-T6-5

Product Description

These general-purpose, AC rated, pushbutton switches offer a wide variety of configurations, button styles and termination types. The 7835 and 7836 light-duty series pushbutton switches are AC only. They feature slow-make/slow-break butt-type contacts with a light operating pressure that is particularly suited to instrumentation applications.

Features

- Circuits
 - 1PST, 1PDT, 2PDT
 - Momentary action
- Terminal Types
 - Screw terminals, brass (furnished unassembled)
 - 8448 Series
 - #6-32 x 3/16 in binding head screws **(Cat. No. 811-2)**
 - 8410/8411 Series
 - #5-40 x 3/16 in **(Cat. No. 811-7206)**
 - 8406/8440 Series
 - #5-40 x 5/32 in screws **(Cat. No. 11-26)**
 - Solder lug, brass silver-plated
- Hardware supplied
 - One hexagon locknut **(Cat. No. 15-192)** and one bright nickel-plated knurled facenut **(Cat. No. 15-124F1)**
 - 8411/8418 Series has a bright nickel-plated hexagon facenut **(Cat. No. 15-966-2)**
 - All hardware is furnished unassembled
 - Other mounting types are flush, nest and snap-in

Standards and Certifications^①

- UL[®] Recognized
- CSA[®] Certified
- RoHS^②



Notes

- ① Except where noted.
- ② Visit www.eaton.com/vcbu for the most up-to-date list of verified part numbers.

Product Selection

Non-Illuminated

Light-Duty, Momentary Contact

Flush



Flush Mounted

Rating	Poles and Throw	Contacts	Circuit Number ^①	Button Construction	Color	Button Extension Dimensions "B" in Inches (mm)	Typical Max. Operating Force	Mounting or Bushing Length Dimensions "A" in Inches (mm)	Catalog Number
Screw Terminals									
1/4 A, 250 Vac/Vdc	1PST	NC	A	Nylon	Black	0.468 (11.89)	0.7 lbs ^③	Flush	8406K1
3/4 A, 125 Vac/Vdc						0.453 (11.50)	0.7 lbs ^③	Flush	8410K1

Snap-in



Snap-in Mounted

Rating	Poles and Throw	Contacts	Circuit Number ^①	Button Construction	Color	Button Extension Dimensions "B" in Inches (mm)	Typical Max. Operating Force	Mounting or Bushing Length Dimensions "A" in Inches (mm)	Catalog Number
Spade Terminals (0.250 in)									
3/4 A, 125 Vac/Vdc	1PST	NC	A	Nylon	White	0.375 (9.53)	—	Snap-in	8423K1 ^⑤
1/4 A, 250 Vac/Vdc		NO	A	Nylon	White	0.375 (9.53)	—	Snap-in	8424K1 ^⑤

Bushing



Bushing Mounted

Rating	Poles and Throw	Contacts	Circuit Number ^①	Button Construction	Color	Button Extension Dimensions "B" in Inches (mm)	Typical Max. Operating Force	Mounting or Bushing Length Dimensions "A" in Inches (mm)	Catalog Number
Solder Lugs									
3/4 A, 125 Vac/Vdc	1PST	NC	A	Nylon	Black	0.250 (6.35)	1.5 lbs ^③	0.250 (6.35)	8411K5
1/4 A, 250 Vac/Vdc									
3/4 A, 125 Vac/Vdc	1PST	NC	A	Nylon	Black	0.406 (10.31)	1.5 lbs ^③	0.468 (11.89)	8411K8
1/4 A, 250 Vac/Vdc									
5 A, 12 Vdc,	1PST	NO	A	Metal	—	0.296 (7.52)	2.5 lbs	0.468 (11.89)	8440K2 ^⑤
3 A, 125 Vac									
1 A, 250 Vac	1PST	NC	A	Nylon	Black	—	—	0.562 (14.27)	7835K11A ^⑥
1/10 hp, 125 Vac				(snap-on)	Red	—	—	0.562 (14.27)	7835K11D
3 A, 125 Vac	1PST	NO	A	Metal	—	0.312 (7.92)	—	0.562 (14.27)	7836K11A ^⑥
1 A, 250 Vac									
1/10 hp, 125 Vac	1PST	NO	A	Nylon	Black	—	—	0.562 (14.27)	7836K11C ^⑥
				(snap-on)	Red	—	—	0.562 (14.27)	7836K11D ^⑥
Screw Terminals									
3/4 A, 125 Vac/Vdc	1PST	NC	A	Nylon	Black	0.406 (10.31)	1.5 lbs ^③	0.468 (11.89)	8411K7
1/4 A, 250 Vac/Vdc		NO				0.375 (9.53)	1.5 lbs ^④	0.468 (11.89)	8411K12
5 A, 12 Vdc,	1PST	NO	A	Metal	—	0.296 (7.52)	2.5 lbs	0.468 (11.89)	8440K3 ^⑤
3 A, 125 Vac									
1 A, 250 Vac	1PST	NO	A	Metal	—	0.312 (7.92)	—	0.562 (14.27)	7836K13A
1/10 hp, 125 Vac									
Wire Leads ^⑦									
3/4 A, 125 Vac	1PST	NC	A	Metal	—	0.312 (7.92)	—	0.562 (14.27)	7835K12A
1 A, 250 Vac									
1/10 hp, 125 Vac	1PST	NO	A	Metal	—	0.312 (7.92)	—	0.562 (14.27)	7836K12A
Spade Terminals (0.250 in)									
1/4 A, 250 Vac/Vdc	1PST	NO	A	Nylon	Red	0.250 (6.35)	1.5 lbs ^④	0.250 (6.35)	8411K13 ^⑤
3/4 A, 125 Vac/Vdc	1PST	NC	A	Nylon	Black	0.406 (10.31)	1.5 lbs ^③	0.468 (11.89)	8411K10
		NO				0.375 (9.53)	1.5 lbs ^④	0.468 (11.89)	8411K11 ^⑤
3 A, 125 Vac	1PST	NC	A	Nylon	Black	0.250 (6.35)	1.5 lbs	0.250 (6.35)	8418K1 ^⑤
		NO				0.406 (10.31)	1.5 lbs	0.468 (11.89)	8418K12 ^⑤

Notes

- ① For circuit number detail, see table on **Page V11-T6-18**.
- ② UL and CSA Listing not applicable.
- ③ To change operating pressure, refer to your local Eaton Sales Representative.
- ④ Operating pressure cannot be changed.
- ⑤ Combination spade and solder lug terminal.
- ⑥ Items are normally in distributor stock.
- ⑦ Standard length is 6 in (152.40 mm), stripped 0.625 in (15.88 mm).

6.1

Pushbuttons

AC Rated

Non-Illuminated

Medium-Duty, Momentary Contact

One-Hole

One-Hole Mounted



6

Rating	Poles and Throw	Contacts	Circuit Number ^①	Button Construction	Color	Button Extension Dimensions "B" in Inches (mm)	Typical Max. Operating Force	Mounting or Bushing Length Dimensions "A" in Inches (mm)	Catalog Number
Screw Terminals									
15 A, 125 Vac 10 A, 250 Vac 1/3 hp, 125–250 Vac	1PST	NO	A	Metal	—	0.531 (13.49)	0.9 lbs	0.687 (17.45)	8444K3
15 A, 125 Vac, NO 10 A, 125 Vac, NC 10 A, 250 Vac, NO 5 A, 250 Vac, NC 1/2 hp, 250 Vac 1/4 hp, 125 Vac	1PDT	NO, NC	B	Metal	—	0.531 (13.49)	2.0 lbs	0.687 (17.45)	8434K2
15 A, 125 Vac 10 A, 250 Vac	2PST	NO	C	Metal	—	0.250 (6.35)	—	0.343 (8.71)	8448K2 ^②
Spade Terminals (0.250 in)									
15 A, 125 Vac 10 A, 250 Vac 1/3 hp, 125–250 Vac	1PST	NO	A	Metal	—	0.531 (13.49)	0.9 lbs	0.687 (17.45)	8444K2
15 A, 125 Vac, NO 10 A, 125 Vac, NC 10 A, 250 Vac, NO 5 A, 250 Vac, NC 1/2 hp, 250 Vac 1/4 hp, 125 Vac	1PDT	NO, NC	B	Metal	—	0.531 (13.49)	2.0 lbs	0.687 (17.45)	8434K1
15 A, 125 Vac 10 A, 250 Vac	2PST	NO	C	Metal	—	0.250 (6.35)	—	0.343 (8.71)	8448K1 ^②

Technical Data and Specifications

AC Rated

Description	Specification
Ratings	See Product Selection tables on Page V11-T6-3 and the table above.
Contact material	
3–6 A rated	Movable, silver-plated copper Stationary, silver-plated copper
10–15 A rated	Movable, silver-plated copper with fine or coin silver contact face button Stationary, copper with fine or coin silver contact face button
Wire leads	18 gauge, 6 in (152 mm) long, skinned 0.75 in (19 mm) Lengths beyond 6 in (152 mm) are additional charge
Mounting means—One-hole mount	Threaded bushing—0.468 in dia. 32 threads/inch (11.90 mm) Keyway—0.068 W x 0.035 D in (1.73 W x 0.89 D mm); provides anti-rotation feature Keyway on 7835/7836 Series is 0.080 W x 0.040 D in (2.03 W x 1.01 D mm)
Operating temperature range	0 °F to 150 °F (–17.8 °C to 65.6 °C)

Notes

- ① For circuit number detail, see table on **Page V11-T6-18**.
- ② UL and CSA Listing not applicable.

Dimensions

Approximate Dimensions in Inches (mm)

7835K12A

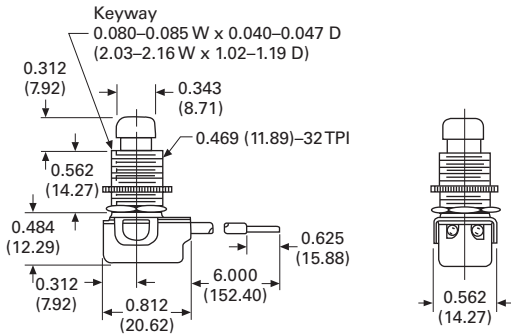

8410

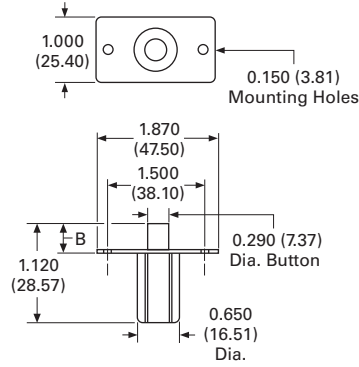

8406

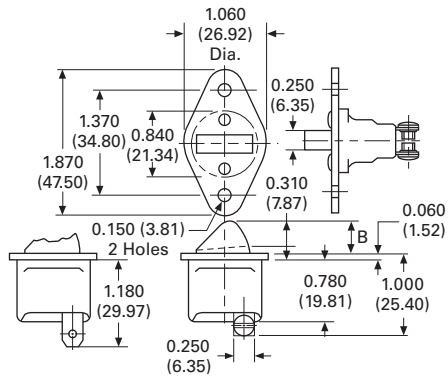

Spade Terminal Screw Type Terminal

8411K5 and 8411K13

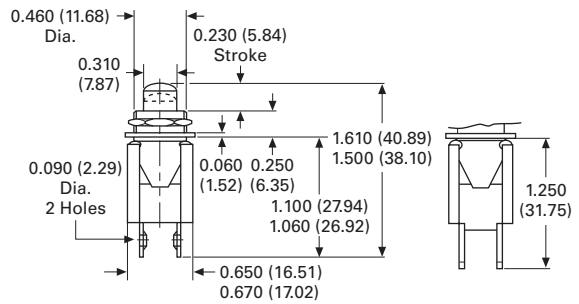

8411K7 and 8411K8

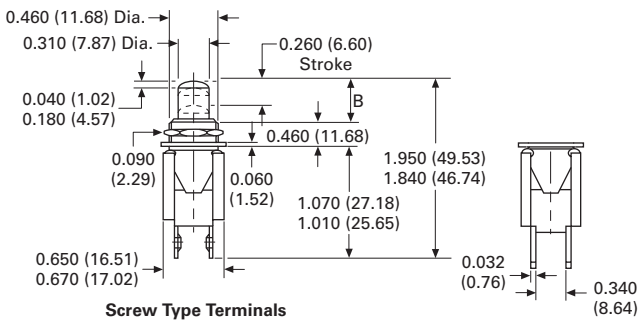

Screw Type Terminals

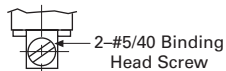

8411K11 and 8411K12

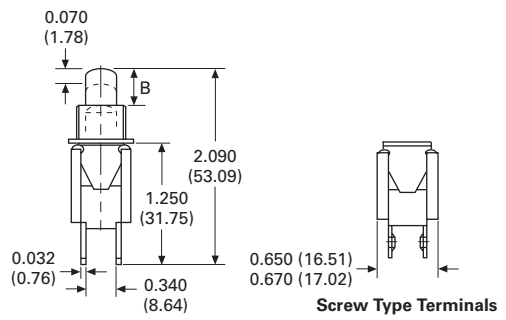

Screw Type Terminals

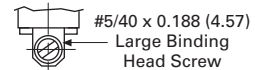

6.1

Pushbuttons

AC Rated

Approximate Dimensions in Inches (mm)

8411K10 and 8418K12

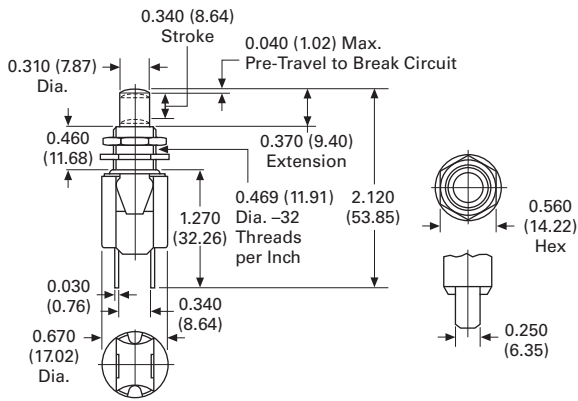

8423 and 8424

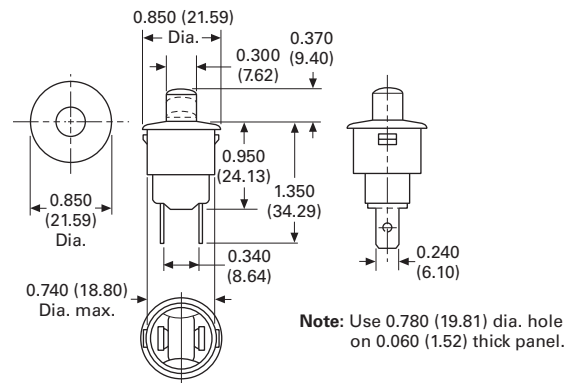

8418K1

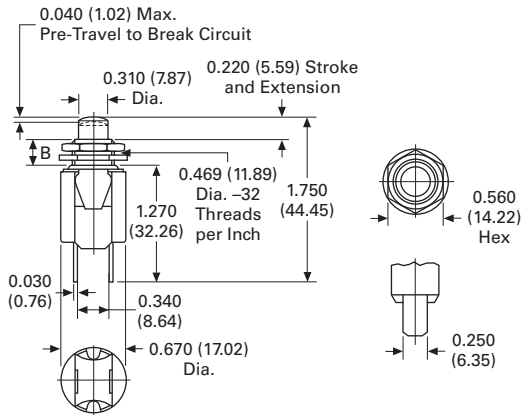

8434K2 and 8435K2

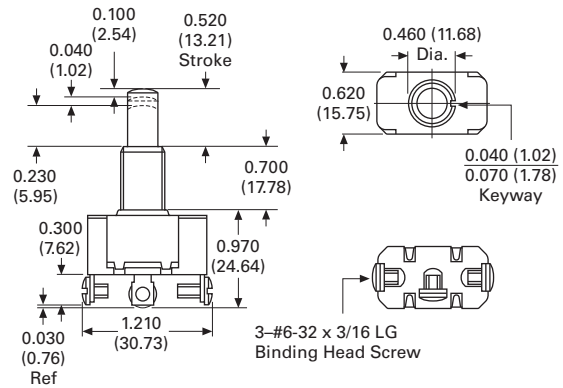

Approximate Dimensions in Inches (mm)

8440

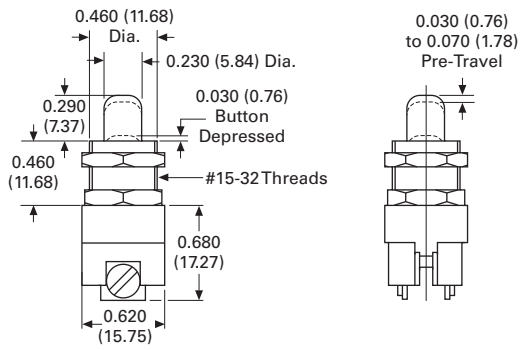

8448K1

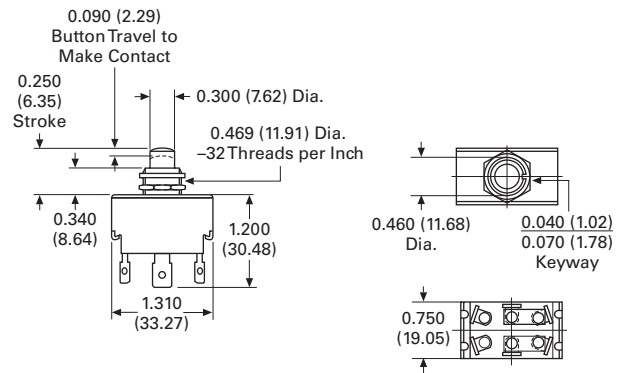

8442 and 8444 (Screw Terminals)

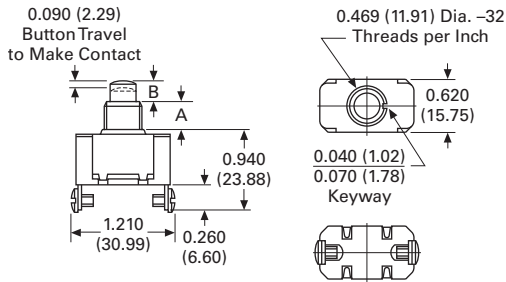

8448K2

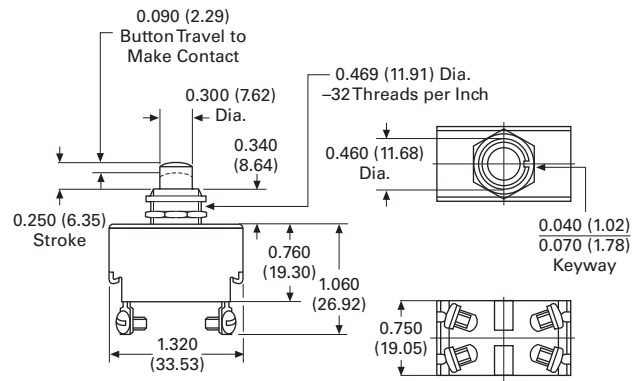

6.2

Pushbuttons

Illuminated AC/DC Rated

Illuminated AC/DC Rated



6

Contents

Description

Description	Page
Illuminated AC/DC Rated	
Catalog Number Selection	V11-T6-9
Lamp Selection	V11-T6-14
Accessories	V11-T6-16
Technical Data and Specifications	V11-T6-17
Terminal Identification	V11-T6-18
Circuit Diagrams	V11-T6-18
Legends	V11-T6-18
Dimensions	V11-T6-19

Product Description

Eaton offers a wide range of pushbutton switches for standard industry applications such as appliances, electronics, medical and test instrumentation, office equipment and many other commercial applications.

A variety of options are available such as illuminated and non-illuminated versions, colored lens caps, lamp styles and mounting styles.

Each pushbutton series offers a matching indicator for a consistent look. See the Product Overview tables to quickly identify the required product. Then, refer to the Catalog Number Selection and Product Selection tables to determine the catalog number.

Standards and Certifications ^①

- UL Recognized
- CSA Certified
- RoHS ^②











Notes

- ^① Except where noted.
- ^② Visit www.eaton.com/vcbu for the most up-to-date list of verified part numbers.

Product Selection Guide

General Purpose Pushbuttons and Indicators—Illuminated and Non-Illuminated

Series	206/208	Page	220/221/224	Page	231/234	Page	580/581/586	Page
Pushbutton Selection—Switch		V11-T6-9		V11-T6-9		V11-T6-9		V11-T6-10
Pushbutton Selection—Indicator		V11-T6-9		V11-T6-9		V11-T6-9		V11-T6-10
Pushbutton Cap Selection		V11-T6-13		V11-T6-13		V11-T6-13		V11-T6-13
Circuit Diagram Letter (See Page V11-T6-18)		K, N		K, N		K, N		J, L, M
Series	770/775	Page	810/815	Page	820/825	Page	860/861/845	Page
Pushbutton Selection—Switch		V11-T6-11		V11-T6-12		V11-T6-12		V11-T6-12
Pushbutton Cap Selection		V11-T6-11		V11-T6-12		V11-T6-12		V11-T6-12
Pushbutton Selection—Indicator		V11-T6-13		V11-T6-13		V11-T6-13		V11-T6-13
Circuit Diagram Letter (See Page V11-T6-18)		Q		K, N		K, N		J, L



Series 206/208, 220 and 221/224, 231/234

Catalog Number Selection

How To Order—Series 206/220 and 221/231, Switch

To determine complete catalog number, start with the appropriate control type and add the appropriate code letters and/or numbers.

Example: **206 K 1 1 9 1 2 D 03 05 S 30**

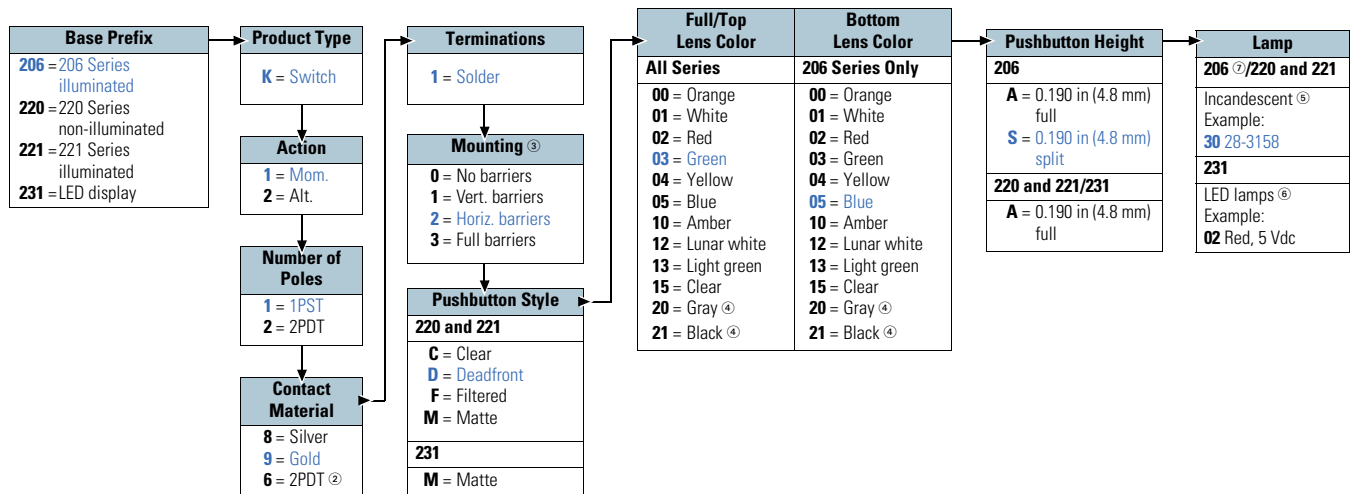

How To Order—Series 208/224/234, Indicator

To determine complete catalog number, start with the appropriate control type and add the appropriate code letters and/or numbers.

Example: **208 L 1 2 D 03 05 S 30**

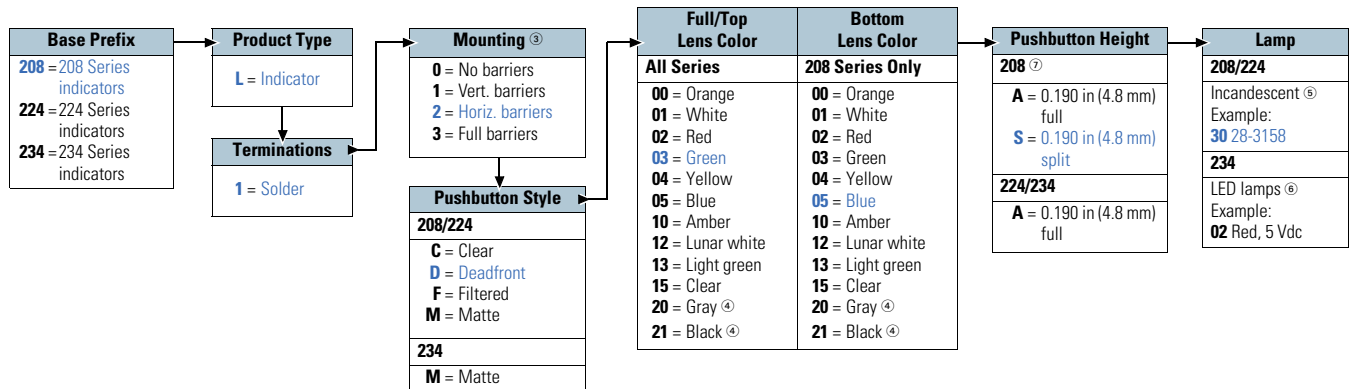

Notes

- ① Full cap style does not require a bottom lens code.
- ② Pole one is silver, pole two is gold.
- ③ Refer to Page V11-T6-16 for barrier information.
- ④ Not available with lighted display.
- ⑤ Use two-digit item number, 30–37, from Incandescent Lamps table on Page V11-T6-14.
- ⑥ Use two-digit item number, 01–19, from LED Lamps table on Page V11-T6-15.
- ⑦ Accepts two bulbs.

6.2

Pushbuttons

Illuminated AC/DC Rated



Series 580/581/586

Catalog Number Selection

6

How To Order—Series 580/581, Switch

To determine complete catalog number, start with the appropriate control type and add the appropriate code letters and/or numbers.

Example: 581 K 1 3 9 1 0 T 03 B 30

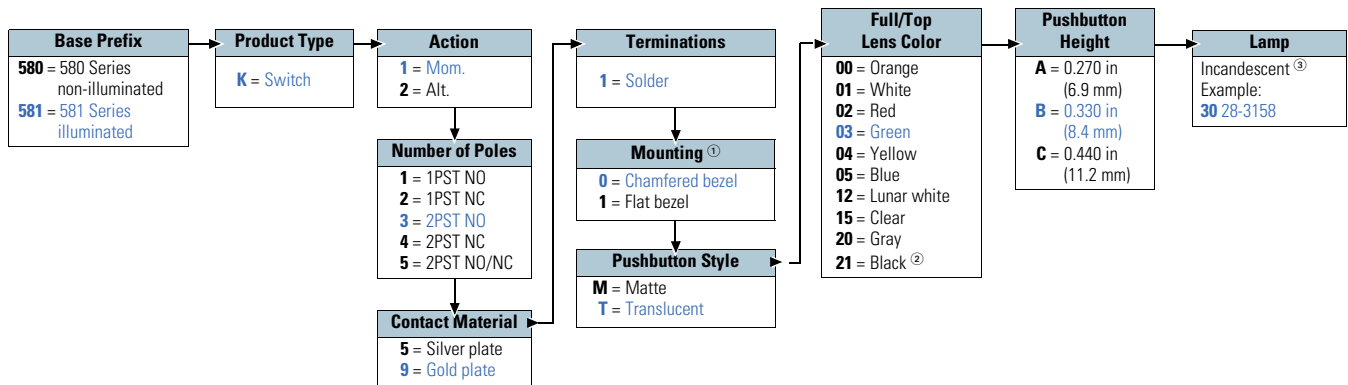

How To Order—Series 586, Indicator

To determine complete catalog number, start with the appropriate control type and add the appropriate code letters and/or numbers.

Example: 586 L 1 0 T 03 B 30

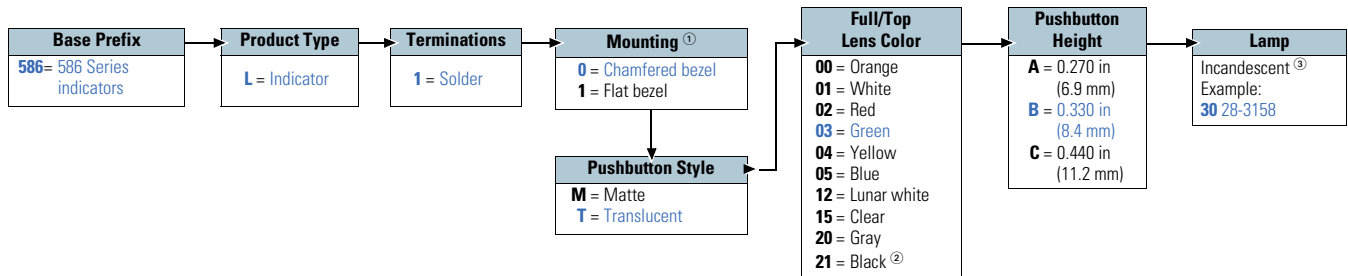

Notes

- ① Flush with bezel.
- ② Not available with lighted display.
- ③ Use two-digit item number, 30–37, from Incandescent Lamps table on **Page V11-T6-14**.



Series 770/775

Catalog Number Selection

How To Order—Series 770^①, Switch

To determine complete catalog number, start with the appropriate control type and add the appropriate code letters and/or numbers.

Example: **770 K 1 1 9 1 1 M 03 01 G 80**

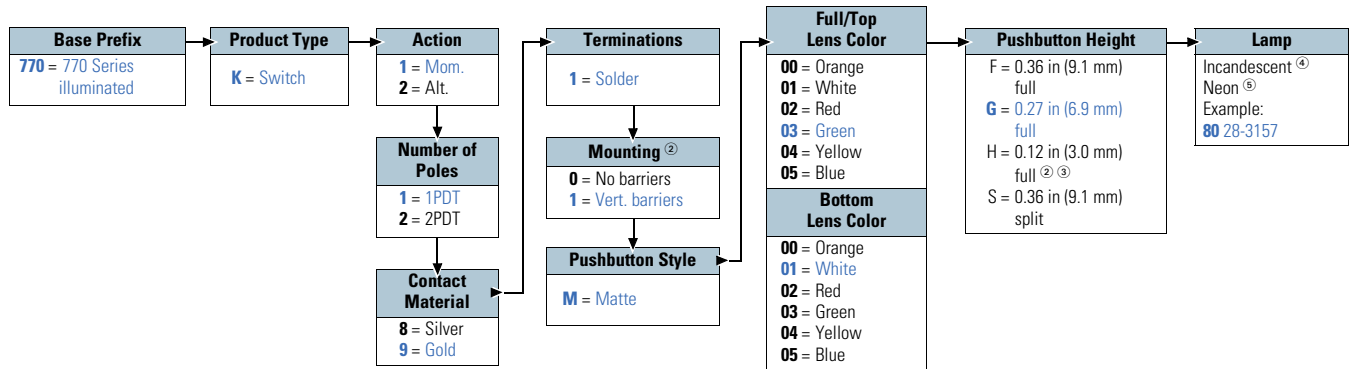

How To Order—Series 775^①, Indicator

To determine complete catalog number, start with the appropriate control type and add the appropriate code letters and/or numbers.

Example: **775 L 1 1 M 03 01 G 80**

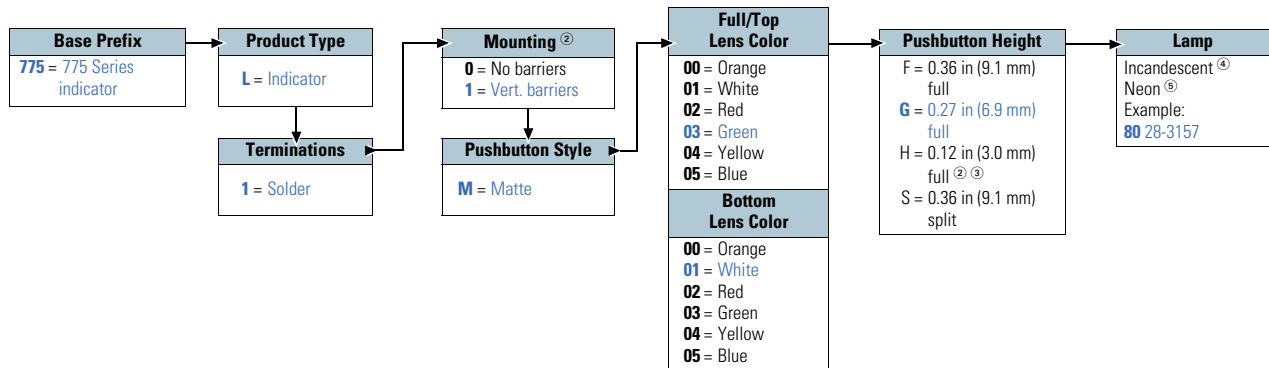

Notes

- ① Full or split cap style available.
- ② Flush with bezel.
- ③ Not available with lighted display.
- ④ Use two-digit item number, 51–59, from Incandescent Lamps table on Page V11-T6-14.
- ⑤ Use two-digit item number, 80 or 81, from Neon Lamps table on Page V11-T6-15.

6.2

Pushbuttons

Illuminated AC/DC Rated



Series 860 and 861/845, 810/815, 820/825

Catalog Number Selection

6

How To Order—Series 860 and 861/810/820, Switch ①

To determine complete catalog number, start with the appropriate control type and add the appropriate code letters and/or numbers.

Example: **861 K 1 3 9 1 2 D 03 B 02**

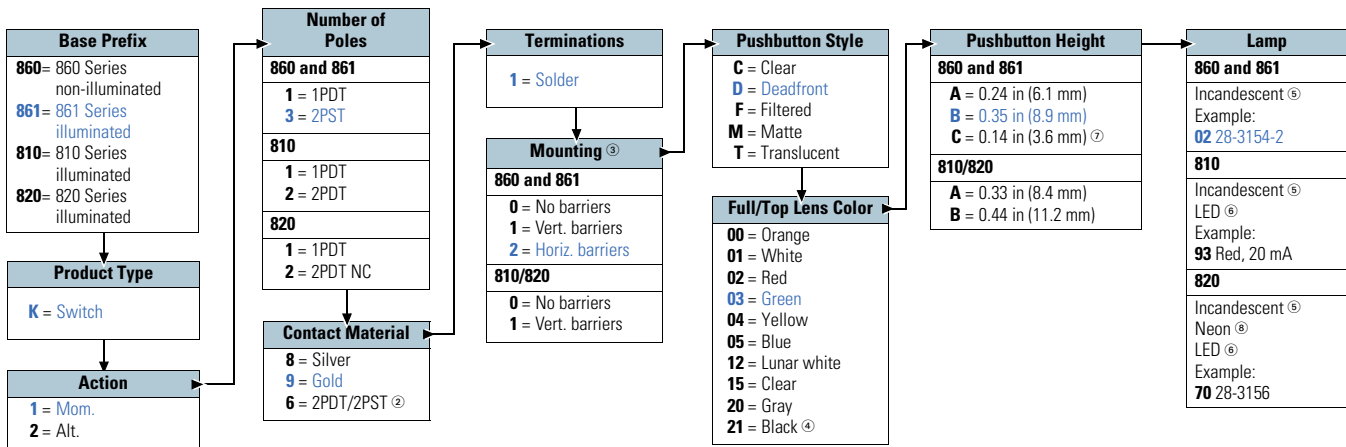

How To Order—Series 845/815/825, Indicator ①

To determine complete catalog number, start with the appropriate control type and add the appropriate code letters and/or numbers.

Example: **845 L 1 2 D 03 B 30**

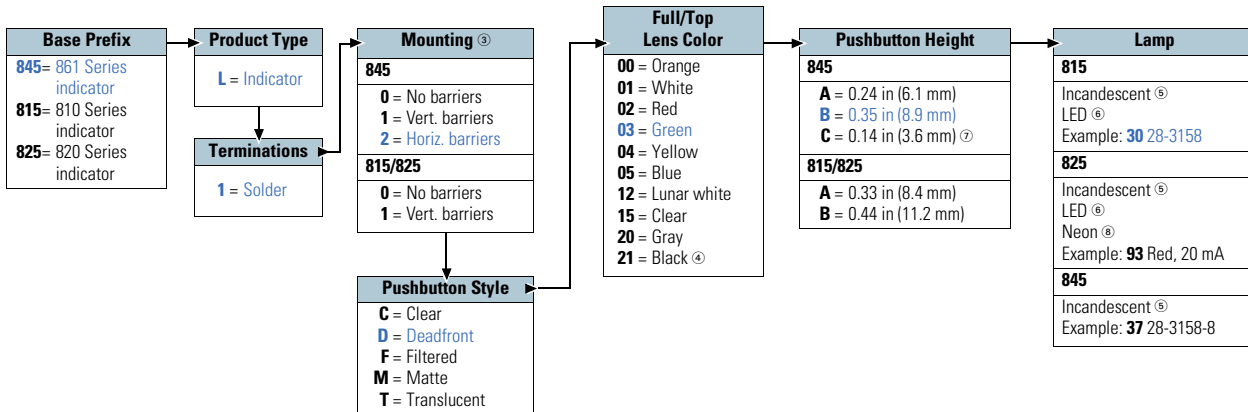

Notes

- ① Full cap style does not require a bottom lens code.
- ② Pole one is silver, pole two is gold.
- ③ Flush with bezel.
- ④ Not available with lighted display.
- ⑤ Use two-digit item number, 02–14, from Incandescent Lamps table on Page V11-T6-14.
- ⑥ Use two-digit item number, 93–97, from LED Lamps table on Page V11-T6-15.
- ⑦ Not available with lighted display. Available only on "M."
- ⑧ Use two-digit item number, 70, from Neon Lamps table on Page V11-T6-15.

Illuminated and Non-Illuminated Pushbutton Caps

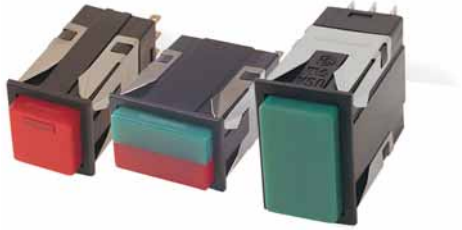

Series 206/220/231 and Series 580/770/810/820/849

Catalog Number Selection

How To Order—Series 206/220/231, Pushbutton Caps

To determine complete catalog number, start with the appropriate control type and add the appropriate code letters and/or numbers.

Example: 206 P C 03 04 S

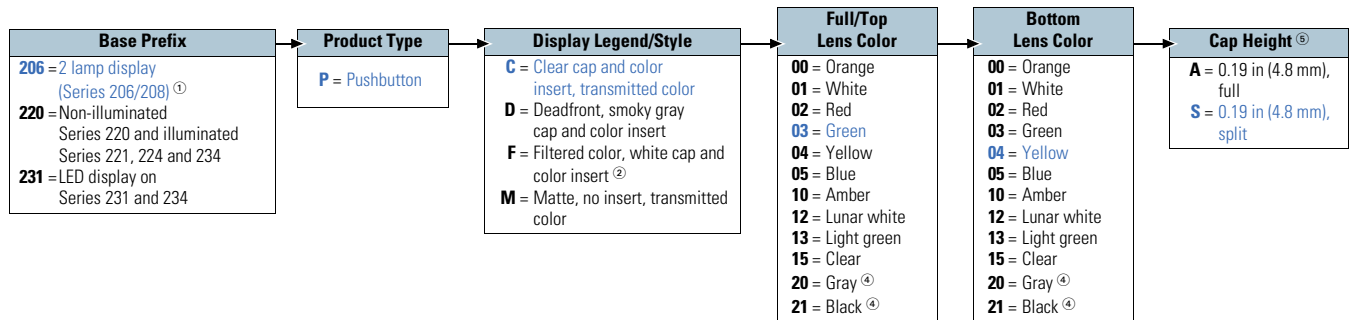

How To Order—Series 580/770/810/820/849, Pushbutton Caps

To determine complete catalog number, start with the appropriate control type and add the appropriate code letters and/or numbers.

Example: 580 P C 03 04 B

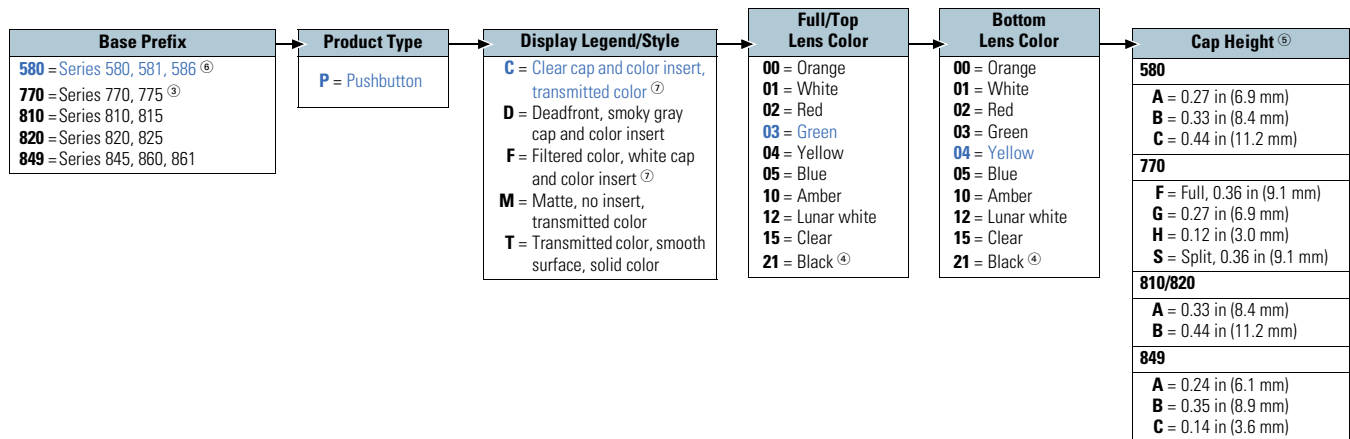

Notes

- ¹ For a high degree of illumination, a full cap may be used with two lamp devices.
- ² Available only with colors red, green, yellow and blue.
- ³ Available in matte only.
- ⁴ Not available for lighted display.
- ⁵ Measured from panel of top of pushbutton cap.
- ⁶ Available in translucent and matte only.
- ⁷ For two lamps, two colored inserts with divider.

Lamp Selection

Incandescent Lamps

Bi-Pin Base for 800 Series

Item Number ^①	To Order Lamp Separately	ASA Lamp Number	Designed Volts	Design Amps	Brightness (MSCP) ^②	Brightness (Lumens)	Lab Average Life (Hours) ^③
02	28-3154-2	7361	5	0.06	0.05	0.63	100,000
03	28-3154-3	7945	6	0.04	0.03	0.38	10,000
07	28-3154-7	7381	6.3	0.20	0.40	5.03	50,000
08	28-3154-8	7371	12	0.04	0.12	1.51	10,000
09	28-3154-9	7330	14	0.08	0.50	6.29	750
10	28-3154-10	7382	14	0.08	0.30	3.77	50,000
11	28-3154-11	7370	18	0.04	0.15	1.89	10,000
12	28-3154-12	7327	28	0.04	0.34	4.27	7,000
13	28-3154-13	7387	28	0.04	0.30	3.77	25,000
14	28-3154-14	7876	28	0.06	0.34	4.27	25,000

Midget Flange Base for 770 Series

Item Number ^①	To Order Lamp Separately	ASA Lamp Number	Designed Volts	Design Amps	Brightness (MSCP) ^②	Brightness (Lumens)	Lab Average Life (Hours) ^③
51	28-3155-2	345	6	0.04	0.03	0.38	10,000
54	28-3155-5	394	12	0.04	0.12	1.51	10,000
55	28-3155-6	330	14	0.08	0.50	6.29	750
56	28-3155-7	382	14	0.08	0.30	3.77	50,000
57	28-3155-8	370	18	0.04	0.15	1.89	10,000
58	28-3155-9	327	28	0.04	0.34	4.27	7,000
59	28-3155-10	387	28	0.04	0.30	3.77	25,000

Subminiature Wedge Base for 200 and 500 Series

Item Number ^①	To Order Lamp Separately	ASA Lamp Number	Designed Volts	Design Amps	Brightness (MSCP) ^②	Brightness (Lumens)	Lab Average Life (Hours) ^③
30	28-3158	56	5	0.115	0.15	1.89	20,000
31	28-3158-2	79	6	0.20	0.60	7.92	1,000
32	28-3158-3	84	6.3	0.04	0.03	0.38	20,000
33	28-3158-4	86	6.3	0.20	0.40	5.03	20,000
34	28-3158-5	18	14	0.04	0.13	1.63	5,000
35	28-3158-6	73	14	0.08	0.30	3.77	15,000
36	28-3158-7	85	28	0.04	0.30	3.77	7,000
37	28-3158-8	17	28	0.06	0.65	8.17	5,000

Notes

① Use this two-digit number for installation in switches and indicators.

② Standard tolerance for MSCP is $\pm 25\%$.

③ Average life is for AC operation. DC life will be approximately 50% less. Operating incandescent lamps at 5–10% below rated voltage will generally increase lamp life 200–400%.

Neon Lamps ^①

T 1-3/4 Bi-Pin Base Neon Lamp for All 800 Series “Shorty” Switches and Indicators ^②

Item Number ^③	To Order Lamp Separately	CLC Lamp Number	Circuit Volts		Nominal Current MA	Average Useful Life (Hours)	External Resistance Required	Ignition Voltage		Bulb Size	Lamp Length	Lead Length
			AC	DC				AC	DC			
70	28-3156	7A1H	105–125	150	1.5	25,000	47K (1/4 W)	95	135	T-2	0.60	0.25

T 1-3/4 Midget Flange Base Neon Lamps for All 700 Series Switches and Indicators ^②

Item Number ^③	To Order Lamp Separately	CLC Lamp Number	Circuit Volts		Nominal Current MA	Average Useful Life (Hours)	External Resistance Required	Built-In Resistance	Ignition Voltage		Bulb Size	Maximum Overall Length
			AC	DC					AC	DC		
80	28-3157	A1H	105–125	150	1.5	25,000	35K (1/4 W)	None	95	135	T-2	0.67
81	28-3157-2	C-24	105–125	150	4.2	8,000	None	35K	95	135	T-2	0.67

LED Lamps ^④

LEDs are sold installed only.

LEDs for Series 231 through 235 Switches and Indicators

Color	Voltage ^⑤	Without Diode Protection	With Diode Protection
		Item Number	Item Number
Red	Vdc ^⑥	01	11
	5 Vdc	02	12
	15 Vdc	03	13
Yellow	Vdc ^⑥	04	14
	5 Vdc	05	15
	15 Vdc	06	16
Green	Vdc ^⑥	07	17
	5 Vdc	08	18
	15 Vdc	09	19

T 1-3/4 Wire LEDs for All 800 Series Switches and Indicators

Item Number ^③	Color	Forward Current (MA) ^⑤	Luminous Intensity (MCD)		Forward Voltage (V) Typical	Diffused or Undiffused
			Minimum	Typical		
93	Red	20	80	160	1.7	Undiffused
95	Green	20	80	160	1.7	Undiffused
96	Yellow	20	80	160	1.7	Undiffused
97	Amber	20	80	160	1.7	Undiffused

Notes





- ① Neon lamps are not recommended for use with colored caps or inserts, especially those colored green or blue.
- ② Recommended external series resistor values shown for indicated average useful life are for lamp and resistor combinations used across 110–125 Vac, 1/4 W, ±10% tolerance.
- ③ Use this two-digit number for installation in switches and indicators.
- ④ For use with clear or white cap only.
- ⑤ 5 Vdc and 15 Vdc include internal current limiting resistor. Other voltages available—contact your local Eaton Sales Representative.
- ⑥ External current limiting required. User must include in circuit—to give current of 20 mA to LED.

Mounting Barriers Ordering Guide

Catalog Number Example: **200B1**

When switches are individually mounted, add 0.10 in (2.54 mm) per switch to the appropriate bezel dimension. When switches are gang mounted, add 0.05 in (1.27 mm) to the appropriate bezel dimension for each switch mounted plus an additional 0.05 in (1.27 mm) to compensate for gang mounting.

Series 200 and 300 Mounting Barriers ^{①②}

Product Series	Product Type	Code	Barrier Type and Description	Code		
200	Barrier	B	End—Short ^③	1		
			Center—Short ^③	2	Type 1	Type 2
			End—Long ^④	3		
			Center—Long ^④	4	Type 3	Type 4

Legending

All legend markings are pad printed in accordance with the limitations below. Standard markings are of condensed gothic type, 1/8 in high characters, with white letters on blue, red and green translucent pushbuttons and black letters on white, yellow, orange and all filtered pushbuttons.



Legending

Pushbutton Size	Standard Pad Print Limitations
1/2 in square pushbuttons	2 lines, 4 characters per line
5/8 in square pushbuttons—full legend	3 lines, 6 characters per line
5/8 in square pushbuttons—split legend	2 lines, 6 characters per line
3/4 in square pushbuttons	3 lines, 7 characters per line
3/4 in x 1 in rectangular pushbutton—full legend	3 lines, 9 characters per line
3/4 in x 1 in rectangular pushbutton—split legend	2 lines, 9 characters per line

Accessories

These snap-on pushbutton caps are made of molded plastic for use with grooved style switches. They are ordered separately for user assembly.



Snap-On Pushbutton Caps—Standard

Description	Button Diameter in Inches (mm)	Catalog Number
Black molded	0.625 (15.88)	53-3338
Red molded	0.625 (15.88)	53-3338-2

Notes

- ① The full guard barrier is molded as an integral part of the switch body and is specified as a part of the complete switch catalog number.
- ② An end barrier is attached to each side of housing. The center barrier is used between devices when gang mounting in a slot array.
- ③ For use with square devices and short side of rectangular devices.
- ④ For use with long side of rectangular devices. Use a center—long between switches if gang mounting.

Technical Data and Specifications

General Purpose Pushbuttons and Indicators—Illuminated and Non-Illuminated

Series	206/208	220/221/224	231/234	580/581/586
Ratings—				
Silver Contacts	5 A at 125 Vac or 250 Vac	5 A at 125 Vac or 250 Vdc	5 A at 125 Vac or 250 Vdc	Silver or Gold: 1 A at 125 Vac
Gold Contacts	0.1 A at 125 Vac/Vdc	0.1 A at 125 Vac/Vdc	0.1 A at 125 Vac/Vdc	Gold-plated contacts for low level
Action	Momentary Alternate with positive latch down	Momentary Alternate with positive latch down	Momentary Alternate with positive latch down	Momentary Alternate with positive latch down
Switch Circuitry	Break before make 1PDT or 2PDT 2-independent lamp circuits	Break before make 1PDT or 2PDT	Break before make 1PDT or 2PDT	Double break 1PST or 2PST
Termination Types	0.02 x 0.11 in (0.51 x 2.79 mm)	0.02 x 0.11 in (0.51 x 2.79 mm) ^①	0.02 x 0.110 in (0.51 x 2.79 mm) ^①	0.01 x 0.11 in (0.31 x 2.79 mm) ^①
Pushbuttons	0.62 x 1.00 in (15.87 x 25.40 mm) Rectangular Full or horizontal split lens Plain, engraved or hot stamped ^②	0.63 in (15.87 mm) Square Plain, engraved or hot stamped ^②	0.63 in (15.87 mm) Square Plain, engraved or hot stamped ^②	0.50 in (12.70 mm) Square 3 heights above panel E ^③ Plain, engraved or hot stamped ^②
Mounting	Snap-in panel mounting Stainless steel retaining clips Panel thickness: 0.03 to 0.19 in (0.76 to 4.76 mm) Barrier mount available ^④	Snap-in panel mounting Stainless steel retaining clips Panel thickness: 0.03 to 0.19 in (0.76 to 4.76 mm) Barrier mount available ^④	Snap-in panel mounting Stainless steel retaining clips Panel thickness: 0.03 to 0.19 in (0.76 to 4.76 mm) Barrier mount available ^④	Snap-in panel mounting Choice of two bezel styles: Chamfered or Flat Stainless steel retaining clips Panel thickness: 0.06 to 0.19 in (1.59 to 4.76 mm)
Lamps	Two T 1-3/4 wedge base lamps Incandescent Front relampable Lamp stationary to reduce mechanical shock to filament	Two T 1-3/4 wedge base lamps Incandescent Front relampable Lamp stationary to reduce mechanical shock to filament	One rectangular LED flush with cap Various voltages available Diode protection available	Two T 1-3/4 wedge base lamps Incandescent Front relampable Lamp stationary to reduce mechanical shock to filament
Pushbutton Travel	0.19 in (2.29 mm)	0.19 in (2.29 mm)	0.19 in (2.29 mm)	0.17 in (4.32)

Series	770/775	810/815	820/825	860/861/845
Ratings—				
Silver Contacts	10.5 A at 125 Vac or 250 Vac	3 A at 125 Vac or 250 Vac	3 A at 125 Vac or 250 Vac	6 A at 125 Vac or 3 A at 250 Vac
Gold Contacts	0.25 A at 125 Vac or 30 Vdc	0.25 A at 125 Vac or 30 Vdc	0.25 A at 125 Vac or 30 Vdc	0.25 A at 125 Vac or 30 Vdc
Action	Momentary Alternate with positive latch down	Momentary Alternate with positive latch down	Momentary Alternate with positive latch down	Momentary Alternate with positive latch down
Switch Circuitry	1PDT or 2PDT (2 circuit) 2-independent lamp circuits	Break before make 1PDT or 2PDT	Break before make 1PDT or 2PDT	Double break 1PST or 2PST, NO
Termination Types	0.02 x 0.125 in (0.25 x 3.18 mm) ^① Epoxy sealed	0.02 x 0.11 in (0.64 x 2.79 mm) ^① Epoxy sealed	0.02 x 0.11 in (0.64 x 2.79 mm) ^① Epoxy sealed	0.02 x 0.11 in (0.64 x 2.79 mm) ^①
Pushbuttons	0.73 x 0.97 in (18.54 x 24.64 mm) Rectangular Plain, engraved or hot stamped ^②	0.75 x 1 in (19.05 x 25.40 mm) Rectangular 2 heights above panel ^③ 5 styles Plain, engraved or hot stamped ^②	0.75 in (19.05 mm) Square 2 heights above panel ^③ 5 styles Plain, engraved or hot stamped ^②	0.62 in (15.87 mm) Square Horizontal split legend (indicator only) 3 heights above bezel ^③ 5 styles Plain, engraved or hot stamped ^②
Mounting	Panel mounting retained by molded sleeve and nut May be individually mounted or gang mounted in horizontal or vertical rows Panel thickness from 0.03 to 0.25 in (0.76 to 6.35 mm) Barrier mount available ^④ Snap mount available	Snap-in panel mounting Stainless steel retaining clips Panel thickness: 0.06 to 0.19 in (1.59 to 4.76 mm) Barrier mount available ^④	Snap-in panel mounting Stainless steel retaining clips Panel thickness: 0.06 to 0.19 in (1.59 to 4.76 mm) Barrier mount available ^④	Snap-in panel mounting Stainless steel retaining clips Panel thickness: 0.06 to 0.19 in (1.59 to 4.76 mm) Barrier mount available ^④
Lamps	Accepts two T 1-3/4 midget flange base lamps Incandescent or neon Front relampable	One T 1-3/4 bi-pin base Incandescent, neon or LED Front relampable Lamp stationary to reduce mechanical shock to filament	One T 1-3/4 bi-pin base Incandescent, neon or LED Front relampable Lamp stationary to reduce mechanical shock to filament	One T 1-3/4 bi-pin base Incandescent, neon or LED Front relampable Lamp stationary to reduce mechanical shock to filament
Pushbutton Travel	0.22 in (5.59 mm)	0.22 in (5.59 mm)	0.22 in (5.59 mm)	0.22 in (5.59 mm)

Notes

- ① Terminations are suitable for solder or female 110 connectors. Series 770: Solder only.
- ② See Engraving and Hot Stamping table on **Page V11-T6-16** for more information.
- ③ See Product Selection tables on **Pages V11-T6-9–V11-T6-12** for more information.
- ④ See Series 200 and 300 Mounting Barriers table on **Page V11-T6-16** for more information.

6.2

Pushbuttons

Illuminated AC/DC Rated

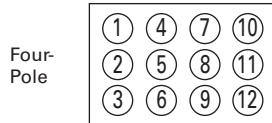
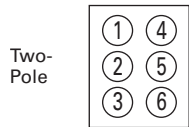
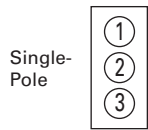

Terminal Identification

When specified on order, switches will have the terminals identified as shown in the illustration at right. Terminal markings will be ink-stamped on the side of the switch case and unused terminal positions will not be identified.

All views are rear of switch with keyway or at down as applicable. Terminal numbers 2, 2 and 5 and 5 and 8 are considered inboard terminals for single-, two- and four-pole switches respectively. All others are considered outboard.

Legends

Pushbutton Legend

Legend	Rocker Switch Type
●	Contact terminal—will make contact with switch lever
○	Isolated terminal—does not make contact with lever
⌋	Center terminal and switch lever
⊗	Bulb
↔	Momentary contact
●	Denotes mechanical contact portion

Notes

- ① Poles 11 and 12 may be eliminated for three-pole devices.
- ② Poles 10, 11 and 12 may be eliminated for three-pole devices.
- ③ Dependent lamp.
- ④ Independent lamp.
- ⑤ Two circuit—indicates a special type of double-throw switch in which the two circuits being controlled may be independent of each other.
- ⑥ For 206 Series, an additional lamp is available.
- ⑦ Available in 1PDT or 2PDT.

Circuit Diagrams

Pushbutton Circuit Diagrams

Circuit Letter	Schematic	Circuit Letter	Schematic
A 1PST		I 2 circuit ⑤	
B 1PDT		J 1PST	
C 2PST		K 1PDT	
D 2PDT		L 2PST	
E 4PST ①		M 2PST	
F 4PDT ②		N ⑥ 2PDT	
G ③ 1PST		P 1PDT	
H ④ 1PDT		Q ⑦ 2 circuit	

Dimensions

Approximate Dimensions in Inches (mm)

206 Series

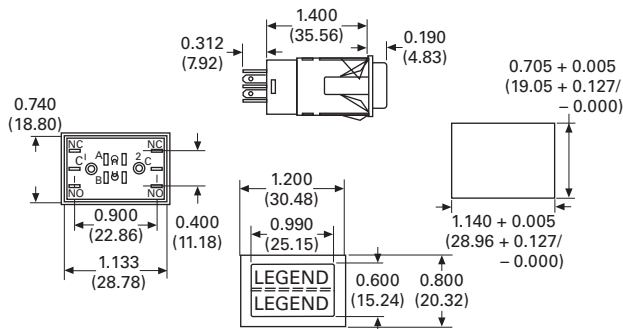

580 Series

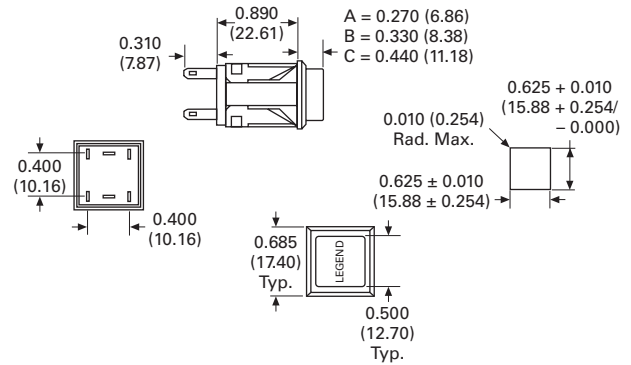

220 Series

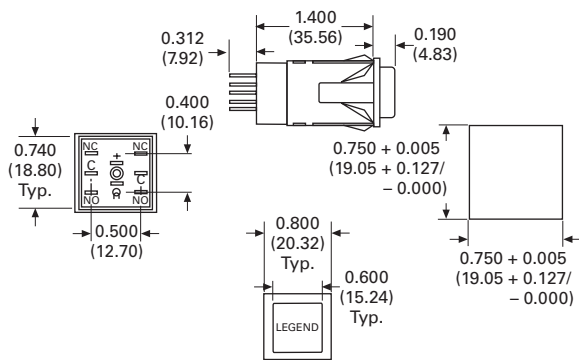

770 Series

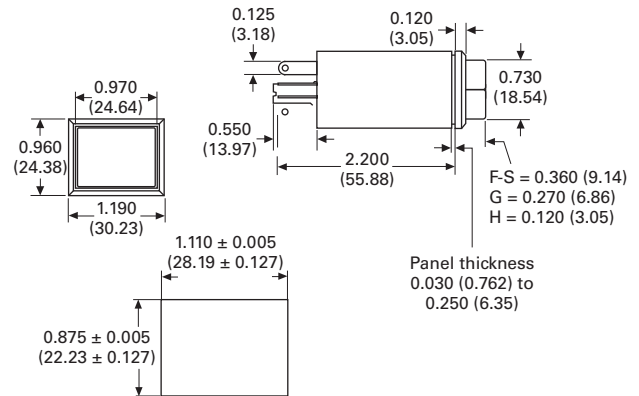

231 Series

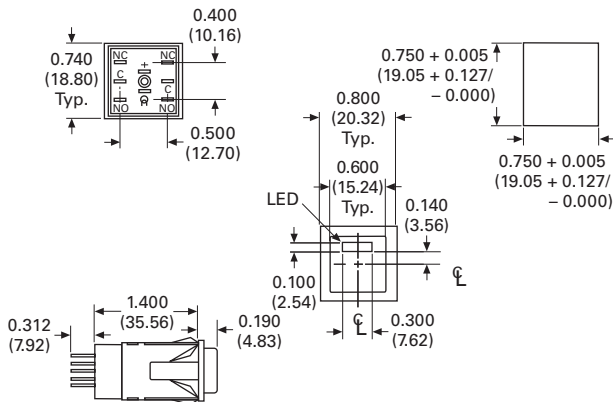

810 Series

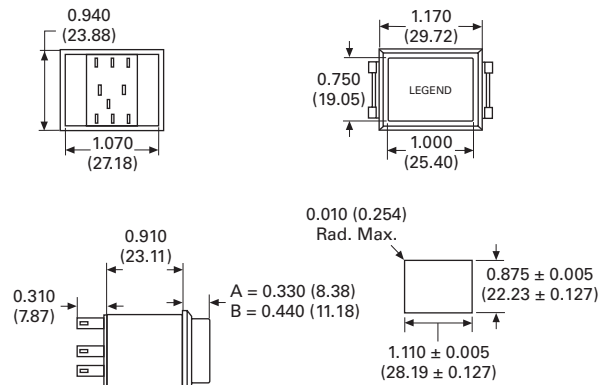

6.2

Pushbuttons

Illuminated AC/DC Rated

Approximate Dimensions in Inches (mm)

820 Series

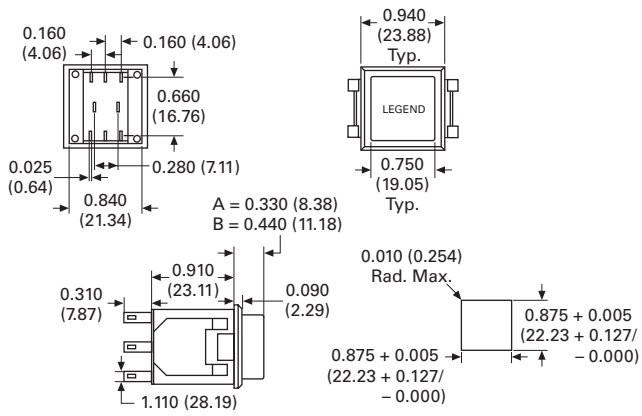

860 Series

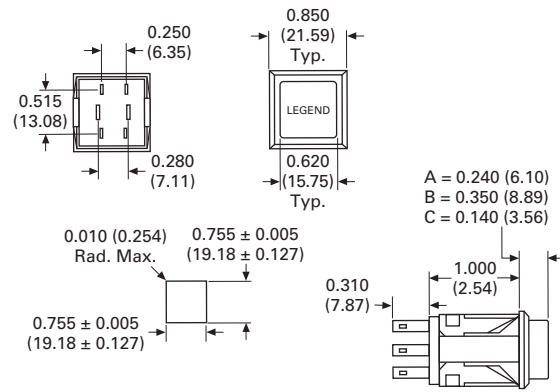

XP Series Sealed Pushbutton



Contents

Description	Page
XP Series Sealed Pushbutton	
Catalog Number Selection	V11-T6-22
Technical Data and Specifications	V11-T6-22
Dimensions	V11-T6-23

Product Description

Eaton’s Vehicle Control business is pleased to offer our newest line of sealed pushbutton switches with multiple color options for ease of application identification.

These pushbuttons are available in a standard circuit: OFF—ON (Momentary).

Included with each switch is the necessary mounting hardware as well as a rubber panel seal gasket.

Application Description

- Lawn and garden equipment
- Industrial and commercial equipment
- Fire trucks and safety vehicles
- Light recreational vehicles

Features

- Mounting hardware included (packaged separately)
 - 5/8 inch internal toothed lock-washer
 - 5/8-24 UNEF-28 panel nut
- Rubber panel seal gasket

Standards and Certifications

- UL Recognition at 6 A, 125 Vac, and 3 A, 250 Vac
- RoHS Compliant ^①



Note

^① Visit www.eaton.com/vcbu for the most up-to-date list of verified part numbers.

6.3

Pushbuttons

XP Series Sealed Pushbutton



XP Series Sealed Pushbuttons

Catalog Number Selection

How To Order—XP Series Sealed Pushbuttons

To determine complete catalog number, start with the appropriate series and add the appropriate code letters and/or numbers.

6

Example: **XP H N T 3 XX**

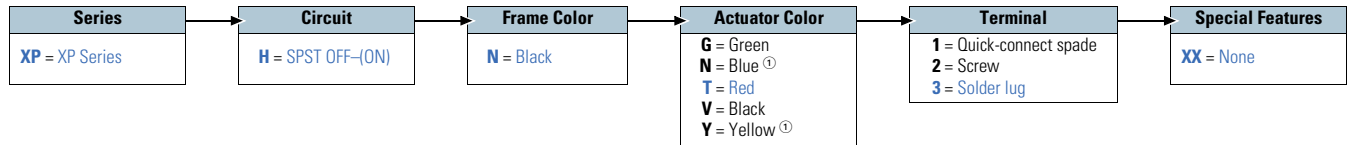

Mounting hardware included (packaged separately)

- Panel nut, internal toothed lock-washer, rubber panel seal gasket



① Contact your local sales representative for price, MOQ and lead-time for yellow and blue version actuator colors.

Technical Data and Specifications

XP Series Sealed Pushbuttons

Description	Specification
Sealed level	IP64
Ratings	3 A: 250 Vac; 6 A: 125 Vac; 10 A: 12 Vdc, 28 Vdc
Mechanical life	1,000,000
Electrical life	25,000
Termination	Solder lugs, screw (M2 X 4), spade (0.189 inch quick-connect)
Operating temperature	-25 °C to 85 °C

Dimensions

Approximate Dimensions in mm [Inches]

XP Series Sealed Pushbuttons

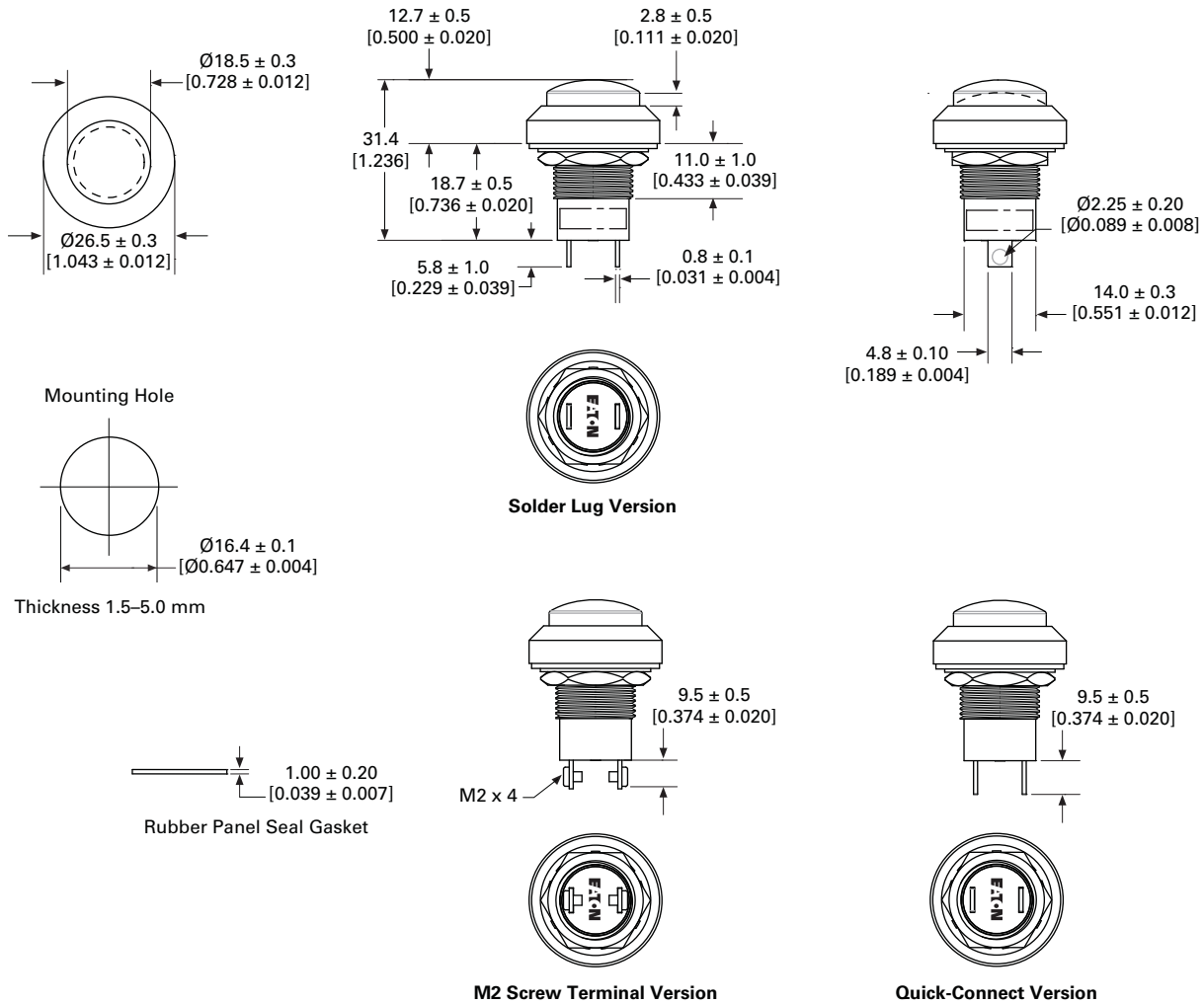







Switch Terminology

Glossary of Terms

Term	Definition
One Pole (1P)—Single Pole (SP)	A switch device that opens, closes or changes connections in a single conductor of an electrical circuit.
Two Pole (2P)—Double Pole (DP)	A switch device that opens, closes or changes connections in both conductors of the same circuit.
Two Circuit (2 CIR.)	A switch device that opens, closes or changes connections in a single conductor of two independent circuits.
Single Throw (ST)	A switch that opens, closes or completes a circuit at only one of the extreme positions of its actuator.
Double Throw (DT)	A switch that opens, closes or completes a circuit at both extreme positions of its actuator.
Normally Open (NO)	A momentary type switch in which one or more circuits are open when the switch actuator is at its normal or rest position.
Normally Closed (NC)	A momentary type switch in which one or more circuits are closed when the switch actuator is at its normal or rest position.
Actuator	A lever, pushbutton, slide, trigger or other means to which an external force is applied to operate a switch mechanism.
Alternate Action (Double Action Push)	Push to make, then push to break a circuit.
Break-Before-Make	A non-shorting switch mechanism that opens or breaks a connection in a conductor before closing or making a connection in another conductor.
Make-Before-Break	A shorting switch mechanism that closes or makes a connection in a conductor before opening or breaking a previous connection in another conductor.
Life Expectancy	The useful life cycle performance of a switch mechanism to open or close, make or break, an electrical circuit, based on statistical probability.
Operating Force	The force that must be applied to the actuator to move it from the free position to the operating position.
Operate Position	The position of the actuator at which the circuit transfers.
Release Force	In a momentary type switch, the value to which the force on the actuator must be reduced to allow the contacts to return to the normal or rest position.
Momentary Action Switches	Momentary action switches turn a process ON and OFF when force is applied and then removed. The applied force can make the circuit change state and the removed force returns circuit to its original state.
Maintained Action Switches	A type of device in which the switch or button physically keeps the circuit in the actuated position.
Half-Throw Circuit	A circuit where the actuator has only two positions (center and one extreme position) with a positive stop that prevents actuator movement to the opposite extreme position.

Approval Marks ^①

Mark	Country/Region	Definition
	U.S.A.	UL [®] Recognized Listing Number: Switches—E24354 or File E1148, WOYR2 1609; Indicator—E70176, E2702
	Canada	UL Recognized Underwriters Laboratories Incorporated; Listing Numbers: E2702, E180275, E43960 and E147754p
	U.S.A. and Canada	UL Recognized Underwriters Laboratories Incorporated; Listing Number: E2702 (but not all sections)
	Canada	CSA [®] —Canadian Standards Associations (Certified) Listing Number: LR10538 or 45995, 9002 Class 6241
	U.S.A.	UL Listed Underwriters Laboratories Incorporated; Listing Number: pE180275
	Europe	ENEC: European Norms Electrical Certification; Listing Number: E2702 (but not all sections)
	—	Restriction of Hazardous Substances (RoHS) Directive 2001/65/EU

Note

^① See specific product for specifications for applicable approvals.

11_	11-T4-33	28-3154_	11-T6-14
13-5496	11-T3-7	28-3155_	11-T6-14
13-8171	11-T3-7	28-3156	11-T6-15
13-8173	11-T3-6, 11-T3-7	28-3157_	11-T6-15
1500_-1507_	11-T2-46	28-3158_	11-T6-14
1500H_	11-T2-47	28-3425_	11-T2-67
15-1043_-15-1047_	11-T4-31	28-3426	11-T2-78
15-1048_	11-T4-31, 11-T4-33	28-5148_	11-T2-67
15-1049_	11-T4-33	28-5415_	11-T2-64
15-124F_	11-T4-31	28-5555_	11-T2-74
15-1525_	11-T4-31	28-5558	11-T2-78
15-189-5	11-T4-31	28-5637-2	11-T2-78
15-192_	11-T4-31	28-5863_	11-T2-13
15-2523_-15-2528_	11-T4-31	28-5901_	11-T2-9
15-2534-14_	11-T4-31	28-5909_	11-T2-9
15-90	11-T4-31	28-5940	11-T2-78
15-966-2	11-T4-31	29-761-5_	11-T4-32
15-994-2	11-T4-31	2CAP_	11-T2-15
1600_-1607_	11-T2-50	2N_	11-T2-14
1600H_-1620H_	11-T2-53	30-2899_	11-T4-34
1609_	11-T2-51, 11-T2-55	30-5632_	11-T4-34
1620HX_	11-T2-53	32-2245	11-T2-39
17-19263	11-T2-79	32-341	11-T4-33
17-19264	11-T2-79	3CAP_	11-T2-15
17-19544-2_	11-T2-79	3N_	11-T2-14
17-21159	11-T2-79	53-3318_	11-T2-79
17-21160	11-T2-79	53-3338_	11-T6-16
17-21543	11-T2-79	53-73	11-T1-11
17-22145	11-T2-42	580K_-581K_	11-T6-10
17-22145_	11-T2-42	580P_	11-T6-13
17-22146	11-T2-42	586L	11-T6-10
17-22152	11-T2-42	61-40_	11-T1-11
17-24	11-T1-11	6CAP_	11-T2-15
200B_	11-T6-16	6N_	11-T2-14
206K_	11-T6-9	7071K_-7073K_	11-T4-9
206P_	11-T6-13	7300K_-7317K_	11-T4-6
208L_	11-T6-9	7500K_-7510K_	11-T4-12, 11-T4-15
220K_-221K_	11-T6-9	7530K_	11-T4-13
220P_	11-T6-13	7546K_	11-T4-12
224L_	11-T6-9	7555K_	11-T4-12
231K_	11-T6-9	7560K_-7569K_	11-T4-13, 11-T4-15
231P_	11-T6-13	7570K_-7571K_	11-T4-13, 11-T4-15
234L_	11-T6-9	7576K_	11-T4-12
2500_-2507_	11-T2-46	7580K_-7587K_	11-T4-12
2500H_	11-T2-47	7590K_-7597K_	11-T4-13
25-13936_	11-T2-42	7630K_-7632K_	11-T4-13
2600_-2607_	11-T2-50	7660K_-7668K_	11-T4-4
2600H_	11-T2-53	7670K_-7674K_	11-T4-4

7690K_–7695K_	11-T4-14	8440K_	11-T6-3
7700K_–7705K_	11-T4-14	8444K_	11-T6-4
770K_	11-T6-11	8448K_	11-T6-4
770P_	11-T6-13	845L_	11-T6-12
775L_	11-T6-11	849P_	11-T6-13
7803K_	11-T4-13	860K_–861K_	11-T6-12
7804K_–7805K_	11-T4-14	8800K_–8860K_	11-T4-4
7810K_–7813K_	11-T4-28	8857K_–8859K_	11-T4-5
7818K_	11-T3-2	8928K_	11-T3-6, 11-T4-20
7835K_–7836K_	11-T6-3	8980K_	11-T3-4
7842K_–7846K_	11-T3-6	B1600_–B1607_	11-T2-52
7933K_–7935K_	11-T4-14	B2600_–B2607_	11-T2-52
7990K_–7992K_	11-T4-28	DP_	11-T5-2
8004K_–8005K_	11-T2-68	DS_	11-T5-2
8006K_–8007K_	11-T2-65	E30	11-T1-7
8055K_–8057K_	11-T2-58	E32	11-T1-10
8064K_–8065K_	11-T2-75	E321	11-T1-11
810K_	11-T6-12	E324	11-T1-11
810P_	11-T6-13	E33	11-T1-14
8130K_–8138K_	11-T2-57	eSM_	11-T1-7, 11-T1-10, 11-T1-11, 11-T1-13
8140K_–8148K_	11-T2-57	eVu_	11-T1-17
8150K_–8155K_	11-T2-57	MS25068_	11-T4-4
815L_	11-T6-12	MS25098_–MS25100_	11-T4-3
8166K_	11-T3-9	MS25125_–MS25127_	11-T4-5
8179K_	11-T2-44	MS25201_	11-T4-4
820K_	11-T6-12	MS35058_–MS35059_	11-T4-4
820P_	11-T6-13	NGR	11-T2-8–11-T2-31
825L_	11-T6-12	NGR Indicators	11-T2-14, 11-T2-15
8261K_–8262K_	11-T4-3	NGR Rocker Buttons	11-T2-11
8280K_	11-T4-20	NGR Switch Base	11-T2-10
8283K_	11-T3-6	P1600_–P1607_	11-T2-50
8290K_–8295K_	11-T4-20	P2600_–P2607_	11-T2-50
8370K_–8373K_	11-T3-6	RW_	11-T5-4
8370K_–8375K_	11-T4-20	SVR	11-T2-32–11-T2-42
8381K_	11-T4-20	SW1RY_	11-T4-33
8391K_–8396K_	11-T4-20	WP_	11-T5-2
8406K_–8411K_	11-T6-3	WS_	11-T5-2
8418K_	11-T6-3	XPHN	11-T6-22
8423K_–8424K_	11-T6-3	XTD_	11-T4-25
8434K_–8435K_	11-T6-4		