

Data sheet | Item number: 2050-1204

2-conductor miniature through terminal block; with operating slots; 1 mm<sup>2</sup>; with test port; side and center marking; for DIN-15 rail; Push-in CAGE CLAMP®; 1,00 mm<sup>2</sup>; blue

[www.wago.com/2050-1204](http://www.wago.com/2050-1204)

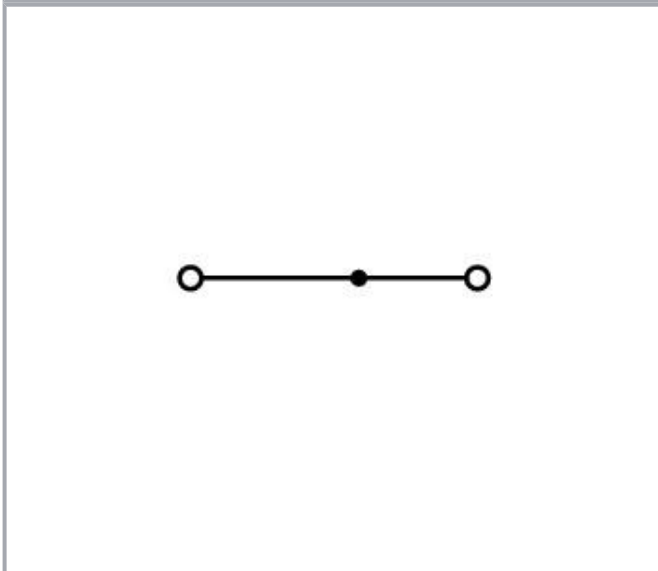
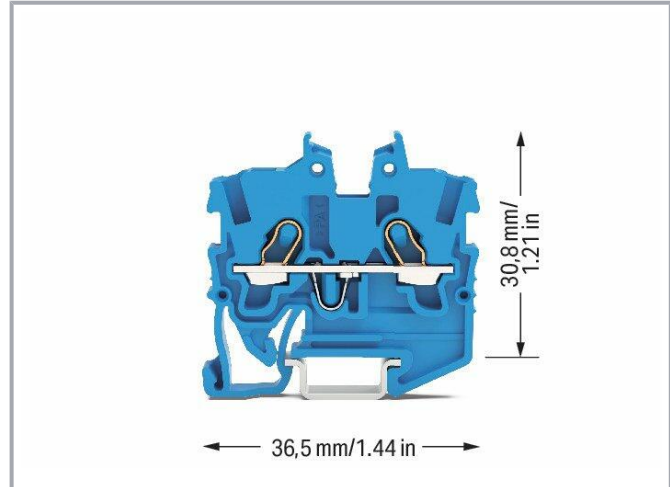
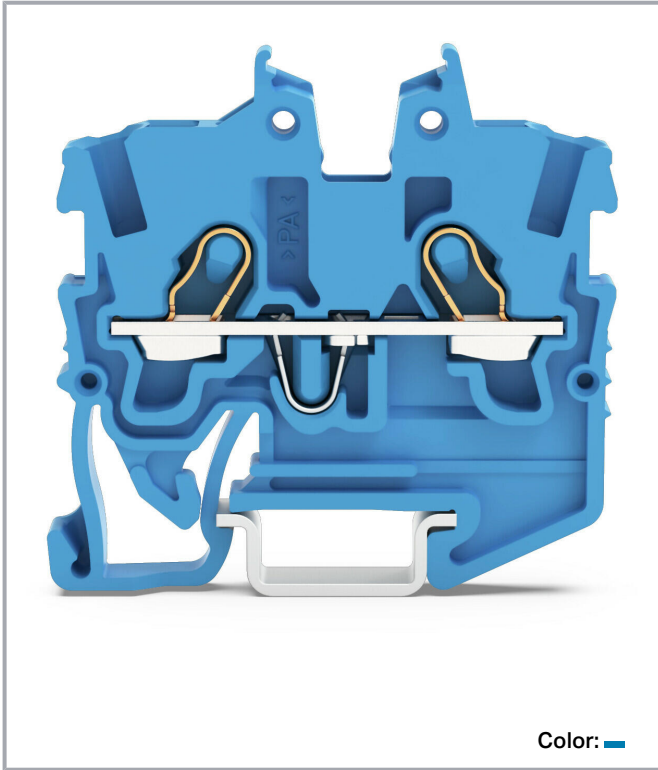

Subject to changes. Please also observe the further product documentation!

WAGO Kontakttechnik GmbH & Co. KG  
Hansastr. 27  
32423 Minden  
Phone: +49571 887-0 | Fax: +49571 887-169  
Email: [info.de@wago.com](mailto:info.de@wago.com) | Web: [www.wago.com](http://www.wago.com)

Do you have any questions about our products?  
We are always happy to take your call at 01788 568 008.



## Data

### Electrical data

#### Ratings per IEC/EN

Ratings per	IEC/EN 60947-7-1
Nominal voltage (III/3)	500 V
Rated surge voltage (III/3)	6 kV
Rated current	13.5 A
Rated current 2	17.5 A
Legend (ratings)	(III / 3) ≙ Overvoltage category III / Pollution degree 3

#### Ratings per UL

Approvals per	UL 1059
Rated voltage UL (Use Group B)	300 V
Rated current UL (Use Group B)	10 A
Rated voltage UL (Use Group C)	300 V
Rated current UL (Use Group C)	10 A

#### Ratings per CSA

Approvals per	C22.2 No 158
Rated voltage CSA (Use Group B)	300 V
Rated current CSA (Use Group B)	10 A
Rated voltage CSA (Use Group C)	300 V
Rated current CSA (Use Group C)	10 A

#### Ex information

Ratings per	ATEX: PTB 19 ATEX 1019 U / IECEx: PTB 19.0050U (Ex eb IIC Gb)
Rated voltage EN (Ex e II)	352 V
Rated current (Ex e II)	13.5 A
Rated current (Ex e II) with jumper	12 A

#### Connection data

Connection technology	Push-in CAGE CLAMP®
Actuation type	Push-in Operating tool
Connectable conductor materials	Copper

Subject to changes. Please also observe the further product documentation!



	Copper
Nominal cross-section	1 mm <sup>2</sup>
Solid conductor	0.14 ... 1.5 mm <sup>2</sup> / 24 ... 16 AWG
Solid conductor; push-in termination	0.5 ... 1.5 mm <sup>2</sup> / 20 ... 16 AWG
Fine-stranded conductor	0.14 ... 1.5 mm <sup>2</sup> / 24 ... 16 AWG
Fine-stranded conductor; with insulated ferrule	0.14 ... 0.75 mm <sup>2</sup> / 24 ... 18 AWG
Fine-stranded conductor; with ferrule; push-in termination	0.5 ... 0.75 mm <sup>2</sup> / 20 ... 18 AWG
Note (conductor cross-section)	Depending on the conductor characteristic, a conductor with a smaller cross-section can also be inserted via push-in termination.
Strip length	9 ... 11 mm / 0.35 ... 0.43 inch
Total number of connection points	2
Total number of potentials	1
Number of levels	1
Wiring direction	Front-entry wiring
Number of jumper slots	1

### Physical data

Width	3.5 mm / 0.138 inch
Height	34.1 mm / 1.343 inch
Depth from upper edge of DIN-rail	27.9 mm / 1.098 inch

### Mechanical data

Design	horizontal type
Mounting type	DIN-15 rail
Marking level	Center/side marking

### Material data

Color	blue
Insulation material	Polyamide (PA66)
Flammability class per UL94	V0
Fire load	0.049 MJ
Weight	2.4 g

### Commercial data

Packaging type	BOX
Country of origin	DE
GTIN	4055143965132

Subject to changes. Please also observe the further product documentation!

WAGO Kontakttechnik GmbH & Co. KG  
 Hansastr. 27  
 32423 Minden  
 Phone: +49571 887-0 | Fax: +49571 887-169  
 Email: [info.de@wago.com](mailto:info.de@wago.com) | Web: [www.wago.com](http://www.wago.com)





Do you have any questions about our products?  
 We are always happy to take your call at 01788 568 008.

Customs tariff number





85369010000

## Approvals / Certificates

### Ex-Approvals

Logo	Approval	Additional Approval Text	Certificate name
	AEx Underwriters Laboratories Inc.	UL 60079	E185892
	ATEX Physikalisch Technische Bundesanstalt	EN IEC 60079-0	PTB 19 ATEX 1019 U (II 2G Ex eb IIC Gb or I M 2 EX eb I Mb)
	CCCEX CQST/CNEx	CNCA-C23-01	2020312313000289
	IECEX Physikalisch Technische Bundesanstalt	IEC 60079	IECEX PTB 19.0050 U (Ex eb IIC Gb or EX eb I Mb)

### Country specific Approvals

Logo	Approval	Additional Approval Text	Certificate name
	CCA DEKRA Certification B.V.	EN 60947	NTR NL 7839
	CCA DEKRA Certification B.V.	EN 60998	NTR NL 7840
	CSA CSA	C22.2 No. 158	80034182
	KEMA/KEUR DEKRA Certification B.V.	EN 60947	71- 113930
	KEMA/KEUR DEKRA Certification B.V.	EN 60998	71- 113957

Subject to changes. Please also observe the further product documentation!



### UL-Approvals

Logo	Approval	Additional Approval Text	Certificate name
	cURus Underwriters Laboratories Inc.	UL 1059	E45172- 20200212





### Required accessories

#### End plate



	<b>Item no.: 2050-1291</b> End and intermediate plate; 1.1 mm thick; gray	<a href="http://www.wago.com/2050-1291">www.wago.com/2050-1291</a>
---	--	--

### Optional accessories

#### Testing and measuring

	<b>Item no.: 2009-174</b> Test plug adapter; for 4 mm Ø test plugs; for testing TOPJOB®S rail-mounted terminal blocks; gray	<a href="http://www.wago.com/2009-174">www.wago.com/2009-174</a>
	<b>Item no.: 2009-182</b> Testing tap; for max. 2.5 mm <sup>2</sup> ; tool-free connection for individual test wires 0.08 - 2.5 mm; gray	<a href="http://www.wago.com/2009-182">www.wago.com/2009-182</a>
	<b>Item no.: 210-136</b> Test plug; 2 mm Ø; with 500 mm cable; red	<a href="http://www.wago.com/210-136">www.wago.com/210-136</a>
	<b>Item no.: 210-137</b> Test plug; 2.3 mm Ø; with 500 mm cable; yellow	<a href="http://www.wago.com/210-137">www.wago.com/210-137</a>

#### Jumpers

	<b>Item no.: 2000-402</b> Jumper; 2-way; insulated; light gray	<a href="http://www.wago.com/2000-402">www.wago.com/2000-402</a>
	<b>Item no.: 2000-402/000-005</b> Jumper; 2-way; insulated; red	<a href="http://www.wago.com/2000-402/000-005">www.wago.com/2000-402/000-005</a>
	<b>Item no.: 2000-402/000-006</b> Jumper; 2-way; insulated; blue	<a href="http://www.wago.com/2000-402/000-006">www.wago.com/2000-402/000-006</a>

Subject to changes. Please also observe the further product documentation!



**Item no.: 2000-402/000-018**  
Jumper; 2-way; insulated; yellow-green

[www.wago.com/2000-402/000-018](http://www.wago.com/2000-402/000-018)



**Item no.: 2000-403**  
Jumper; 3-way; insulated; light gray

[www.wago.com/2000-403](http://www.wago.com/2000-403)



**Item no.: 2000-403/000-005**  
Jumper; 3-way; insulated; red

[www.wago.com/2000-403/000-005](http://www.wago.com/2000-403/000-005)



**Item no.: 2000-403/000-006**  
Jumper; 3-way; insulated; blue

[www.wago.com/2000-403/000-006](http://www.wago.com/2000-403/000-006)



**Item no.: 2000-404**  
Jumper; 4-way; insulated; light gray

[www.wago.com/2000-404](http://www.wago.com/2000-404)



**Item no.: 2000-404/000-005**  
Jumper; 4-way; insulated; red

[www.wago.com/2000-404/000-005](http://www.wago.com/2000-404/000-005)



**Item no.: 2000-404/000-006**  
Jumper; 4-way; insulated; blue

[www.wago.com/2000-404/000-006](http://www.wago.com/2000-404/000-006)



**Item no.: 2000-405**  
Jumper; 5-way; insulated; light gray

[www.wago.com/2000-405](http://www.wago.com/2000-405)



**Item no.: 2000-405/000-005**  
Jumper; 5-way; insulated; red

[www.wago.com/2000-405/000-005](http://www.wago.com/2000-405/000-005)



**Item no.: 2000-405/000-006**  
Jumper; 5-way; insulated; blue

[www.wago.com/2000-405/000-006](http://www.wago.com/2000-405/000-006)



**Item no.: 2000-405/011-000**  
Star point jumper; 3-way; insulated; light gray

[www.wago.com/2000-405/011-000](http://www.wago.com/2000-405/011-000)



**Item no.: 2000-406**  
Jumper; 6-way; insulated; light gray

[www.wago.com/2000-406](http://www.wago.com/2000-406)



**Item no.: 2000-406/000-005**  
Jumper; 6-way; insulated; red















[www.wago.com/2000-406/000-005](http://www.wago.com/2000-406/000-005)



















**Item no.: 2000-406/000-006**  
Jumper; 6-way; insulated; blue

[www.wago.com/2000-406/000-006](http://www.wago.com/2000-406/000-006)

Subject to changes. Please also observe the further product documentation!

	<b>Item no.: 2000-406/020-000</b> Delta jumper; insulated; light gray	<a href="http://www.wago.com/2000-406/020-000">www.wago.com/2000-406/020-000</a>
	<b>Item no.: 2000-407</b> Jumper; 7-way; insulated; light gray	<a href="http://www.wago.com/2000-407">www.wago.com/2000-407</a>
	<b>Item no.: 2000-407/000-005</b> Jumper; 7-way; insulated; red	<a href="http://www.wago.com/2000-407/000-005">www.wago.com/2000-407/000-005</a>
	<b>Item no.: 2000-407/000-006</b> Jumper; 7-way; insulated; blue	<a href="http://www.wago.com/2000-407/000-006">www.wago.com/2000-407/000-006</a>
	<b>Item no.: 2000-408</b> Jumper; 8-way; insulated; light gray	<a href="http://www.wago.com/2000-408">www.wago.com/2000-408</a>
	<b>Item no.: 2000-408/000-005</b> Jumper; 8-way; insulated; red	<a href="http://www.wago.com/2000-408/000-005">www.wago.com/2000-408/000-005</a>
	<b>Item no.: 2000-408/000-006</b> Jumper; 8-way; insulated; blue	<a href="http://www.wago.com/2000-408/000-006">www.wago.com/2000-408/000-006</a>
	<b>Item no.: 2000-409</b> Jumper; 9-way; insulated; light gray	<a href="http://www.wago.com/2000-409">www.wago.com/2000-409</a>
	<b>Item no.: 2000-409/000-005</b> Jumper; 9-way; insulated; red	<a href="http://www.wago.com/2000-409/000-005">www.wago.com/2000-409/000-005</a>
	<b>Item no.: 2000-409/000-006</b> Jumper; 9-way; insulated; blue	<a href="http://www.wago.com/2000-409/000-006">www.wago.com/2000-409/000-006</a>
	<b>Item no.: 2000-410</b> Jumper; 10-way; insulated; light gray	<a href="http://www.wago.com/2000-410">www.wago.com/2000-410</a>
	<b>Item no.: 2000-410/000-005</b> Jumper; 10-way; insulated; red	<a href="http://www.wago.com/2000-410/000-005">www.wago.com/2000-410/000-005</a>
	<b>Item no.: 2000-410/000-006</b> Jumper; 10-way; insulated; blue	<a href="http://www.wago.com/2000-410/000-006">www.wago.com/2000-410/000-006</a>
	<b>Item no.: 2000-433</b> Jumper; from 1 to 3; insulated; light gray	<a href="http://www.wago.com/2000-433">www.wago.com/2000-433</a>
	<b>Item no.: 2000-433/000-005</b> Jumper; from 1 to 3; insulated; red	<a href="http://www.wago.com/2000-433/000-005">www.wago.com/2000-433/000-005</a>

Subject to changes. Please also observe the further product documentation!





	<b>Item no.: 2000-433/000-006</b> Jumper; from 1 to 3; insulated; blue	<a href="http://www.wago.com/2000-433/000-006">www.wago.com/2000-433/000-006</a>
	<b>Item no.: 2000-434</b> Jumper; from 1 to 4; insulated; light gray	<a href="http://www.wago.com/2000-434">www.wago.com/2000-434</a>
	<b>Item no.: 2000-435</b> Jumper; from 1 to 5; insulated; light gray	<a href="http://www.wago.com/2000-435">www.wago.com/2000-435</a>
	<b>Item no.: 2000-436</b> Jumper; from 1 to 6; insulated; light gray	<a href="http://www.wago.com/2000-436">www.wago.com/2000-436</a>
	<b>Item no.: 2000-437</b> Jumper; from 1 to 7; insulated; light gray	<a href="http://www.wago.com/2000-437">www.wago.com/2000-437</a>
	<b>Item no.: 2000-438</b> Jumper; from 1 to 8; insulated; light gray	<a href="http://www.wago.com/2000-438">www.wago.com/2000-438</a>
	<b>Item no.: 2000-439</b> Jumper; from 1 to 9; insulated; light gray	<a href="http://www.wago.com/2000-439">www.wago.com/2000-439</a>
	<b>Item no.: 2000-440</b> Jumper; from 1 to 10; insulated; light gray	<a href="http://www.wago.com/2000-440">www.wago.com/2000-440</a>
	<b>Item no.: 210-103</b> Wire commoning chain; insulated; black	<a href="http://www.wago.com/210-103">www.wago.com/210-103</a>
	<b>Item no.: 210-123</b> Wire commoning chain; insulated; blue	<a href="http://www.wago.com/210-123">www.wago.com/210-123</a>
<b>Mounting</b>		
	<b>Item no.: 249-101</b> Screwless end stop; 6 mm wide; for WMB markers; gray	<a href="http://www.wago.com/249-101">www.wago.com/249-101</a>
<b>Push-in type wire jumper</b>		
	<b>Item no.: 2009-402</b> Push-in type wire jumper; 0.75 mm <sup>2</sup> ; insulated; 60 mm long; gray	<a href="http://www.wago.com/2009-402">www.wago.com/2009-402</a>
	<b>Item no.: 2009-404</b> Push-in type wire jumper; 0.75 mm <sup>2</sup> ; insulated; 110 mm long; gray	<a href="http://www.wago.com/2009-404">www.wago.com/2009-404</a>
	<b>Item no.: 2009-406</b> Push-in type wire jumper; 0.75 mm <sup>2</sup> ; insulated; 250 mm long; gray	<a href="http://www.wago.com/2009-406">www.wago.com/2009-406</a>
<b>Protective warning marker</b>		
	<b>Item no.: 2000-115</b> Protective warning marker; with high-voltage symbol, black; for 5 terminal blocks; yellow	<a href="http://www.wago.com/2000-115">www.wago.com/2000-115</a>
<b>Carrier rail</b>		
	<b>Item no.: 210-111</b> Steel carrier rail; 15 x 5.5 mm; 1 mm thick; 2 m long; slotted; according to EN 60715; silver-colored	<a href="http://www.wago.com/210-111">www.wago.com/210-111</a>

Subject to changes. Please also observe the further product documentation!



	<b>Item no.: 210-295</b> Steel carrier rail; 15 x 5.5 mm; 1 mm thick; 2 m long; unslotted; according to EN 60715; silver-colored	<a href="http://www.wago.com/210-295">www.wago.com/210-295</a>
	<b>Item no.: 210-296</b> Aluminum carrier rail; 15 x 5.5 mm; 1 mm thick; 2 m long; unslotted; similar to EN 60715; silver-colored	<a href="http://www.wago.com/210-296">www.wago.com/210-296</a>
<b>Tool</b>		
	<b>Item no.: 210-647</b> Operating tool; Blade: 2.5 x 0.4 mm; with a partially insulated shaft; multicoloured	<a href="http://www.wago.com/210-647">www.wago.com/210-647</a>
	<b>Item no.: 210-648</b> Operating tool; Blade: 2.5 x 0.4 mm; with a partially insulated shaft; angled; short	<a href="http://www.wago.com/210-648">www.wago.com/210-648</a>
	<b>Item no.: 210-719</b> Operating tool; Blade: 2.5 x 0.4 mm; with a partially insulated shaft	<a href="http://www.wago.com/210-719">www.wago.com/210-719</a>
<b>Marking accessories</b>		
	<b>Item no.: 2009-110</b> Marking strips; for Smart Printer; on reel; not stretchable; plain; snap-on type; white	<a href="http://www.wago.com/2009-110">www.wago.com/2009-110</a>
	<b>Item no.: 2009-113</b> WMB-Inline; for Smart Printer; 2300 pieces on roll; plain; snap-on type; white	<a href="http://www.wago.com/2009-113">www.wago.com/2009-113</a>
	<b>Item no.: 2009-113/000-002</b> WMB-Inline; for Smart Printer; 2300 pieces on roll; plain; snap-on type; yellow	<a href="http://www.wago.com/2009-113/000-002">www.wago.com/2009-113/000-002</a>
	<b>Item no.: 2009-113/000-005</b> WMB-Inline; for Smart Printer; 2300 pieces on roll; plain; snap-on type; red	<a href="http://www.wago.com/2009-113/000-005">www.wago.com/2009-113/000-005</a>
	<b>Item no.: 2009-113/000-006</b> WMB-Inline; for Smart Printer; 2300 pieces on roll; plain; snap-on type; blue	<a href="http://www.wago.com/2009-113/000-006">www.wago.com/2009-113/000-006</a>
	<b>Item no.: 2009-113/000-007</b> WMB-Inline; for Smart Printer; 2300 pieces on roll; plain; snap-on type; gray	<a href="http://www.wago.com/2009-113/000-007">www.wago.com/2009-113/000-007</a>
	<b>Item no.: 2009-113/000-012</b> WMB-Inline; for Smart Printer; 2300 pieces on roll; plain; snap-on type; orange	<a href="http://www.wago.com/2009-113/000-012">www.wago.com/2009-113/000-012</a>
	<b>Item no.: 2009-113/000-017</b> WMB-Inline; for Smart Printer; 2300 pieces on roll; plain; snap-on type; light green	<a href="http://www.wago.com/2009-113/000-017">www.wago.com/2009-113/000-017</a>
	<b>Item no.: 2009-113/000-023</b> WMB-Inline; for Smart Printer; 2300 pieces on roll; plain; snap-on type; green	<a href="http://www.wago.com/2009-113/000-023">www.wago.com/2009-113/000-023</a>
	<b>Item no.: 2009-113/000-024</b> WMB-Inline; for Smart Printer; 2300 pieces on roll; plain; snap-on type; violet	<a href="http://www.wago.com/2009-113/000-024">www.wago.com/2009-113/000-024</a>

Subject to changes. Please also observe the further product documentation!

	<b>Item no.: 2009-191</b> Group marker carrier	<a href="http://www.wago.com/2009-191">www.wago.com/2009-191</a>
	<b>Item no.: 793-3501</b> WMB marking card; as card; plain; snap-on type; white	<a href="http://www.wago.com/793-3501">www.wago.com/793-3501</a>
<b>Ferrule</b>		
	<b>Item no.: 216-241</b> Ferrule; Sleeve for 0.5 mm <sup>2</sup> / 20 AWG; insulated; electro-tin plated; electrolytic copper; gastight crimped; acc. to DIN 46228, Part 4/09.90; white	<a href="http://www.wago.com/216-241">www.wago.com/216-241</a>
	<b>Item no.: 216-242</b> Ferrule; Sleeve for 0.75 mm <sup>2</sup> / 18 AWG; insulated; electro-tin plated; electrolytic copper; gastight crimped; acc. to DIN 46228, Part 4/09.90; gray	<a href="http://www.wago.com/216-242">www.wago.com/216-242</a>
	<b>Item no.: 216-243</b> Ferrule; Sleeve for 1 mm <sup>2</sup> / AWG 18; insulated; electro-tin plated; electrolytic copper; gastight crimped; acc. to DIN 46228, Part 4/09.90; red	<a href="http://www.wago.com/216-243">www.wago.com/216-243</a>

## Downloads

### Documentation

#### Additional Information

Technical explanations	3 Apr 2019	pdf 2.2 MB	Download
------------------------	------------	---------------	----------

## CAD/CAE-Data

### CAD data

2D/3D Models 2050-1204	URL	Download
------------------------	-----	----------

### CAE data

ZUKEN Portal 2050-1204	URL	Download
------------------------	-----	----------

EPLAN Data Portal 2050-1204	URL	Download
-----------------------------	-----	----------

	URL	Download
--	-----	----------

## Environmental Product Compliance

### Compliance Search

Environmental Product Compliance 2050-1204	URL	Download
--	-----	----------

2-conductor miniature through terminal block; with operating slots; 1 mm<sup>2</sup>; with test port; side and center marking; for DIN-15 rail; Push-in CAGE CLAMP®; 1,00 mm<sup>2</sup>; blue

Subject to changes. Please also observe the further product documentation!

## Installation Notes

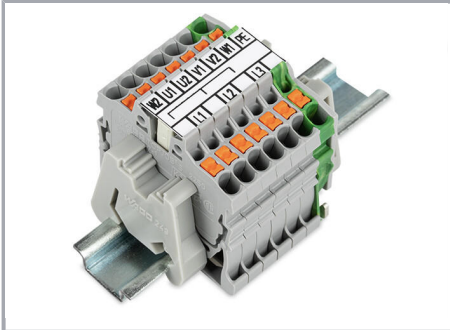

### Conductor termination

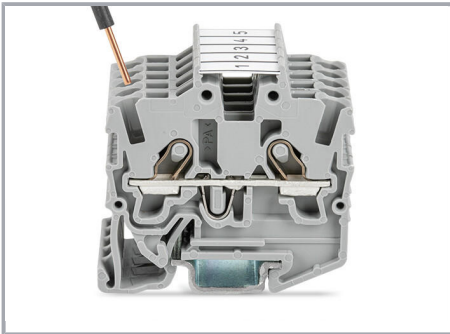

Insert solid conductors via push-in termination.



Insert ferruled conductors via push-in termination.

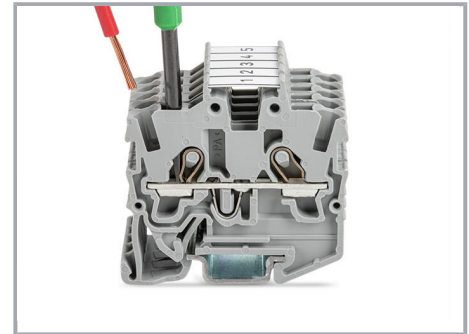

Insert fine-stranded conductors via operating tool.

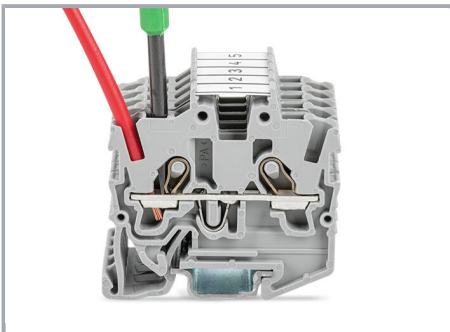

Remove all conductors via operating tool.

### Commoning

Subject to changes. Please also observe the further product documentation!

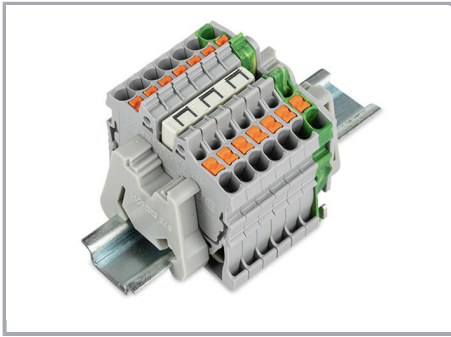

Insert a jumper (delta jumper) and push down until it hits the backstop (picture shows terminal blocks with push-buttons).

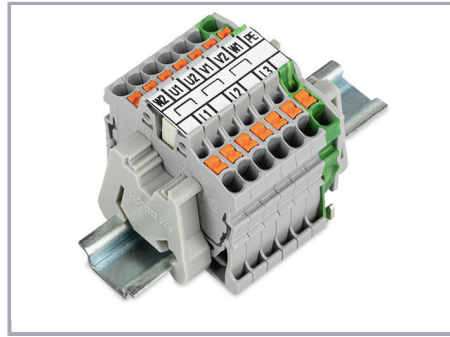

Marking strip (2009-110) inserted in the marking slot with jumper symbols of the inserted jumper (picture shows terminal blocks with push-buttons)

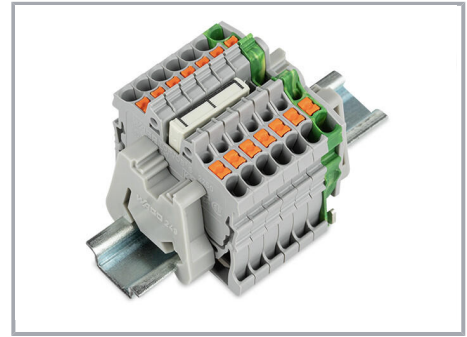

Insert a jumper (star point jumper) and push down until it hits the backstop (picture shows terminal blocks with push-buttons).

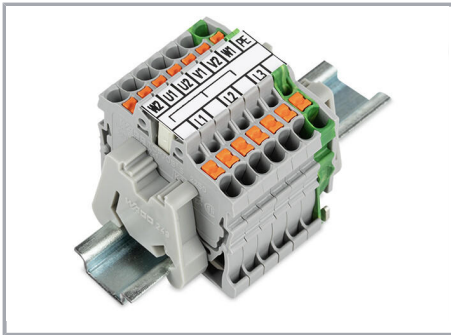

Marking strip (2009-110) inserted in the marking slot with jumper symbols of the inserted jumper (2000-405/011-000 Delta Jumper) (picture shows terminal blocks with push-buttons)

### Testing

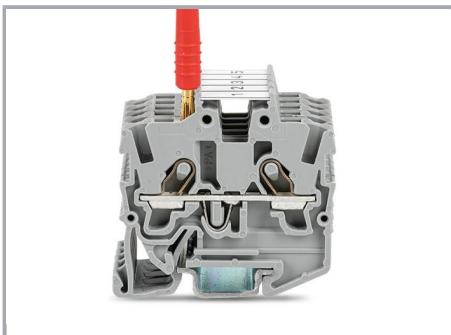

Testing with a 2 mm Ø 210-136 Test Plug (max. 42 V).

### Marking

Subject to changes. Please also observe the further product documentation!

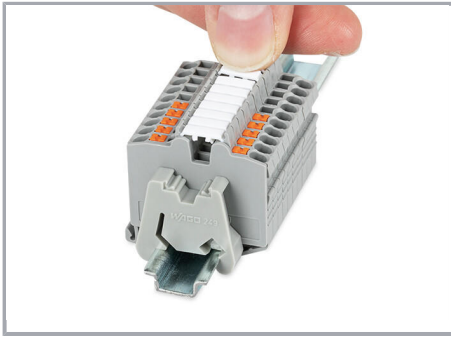

Snapping a WMB marking strip into a marker slot.

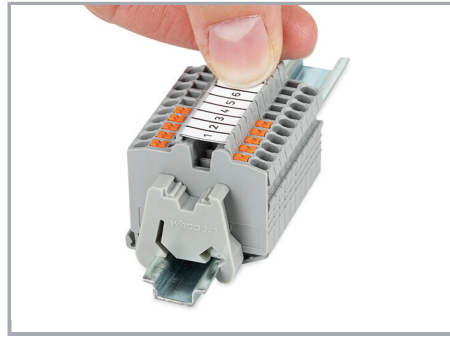

Snapping a marking strip (2009-110) into a marker slot.

## Product family

### TOPJOB® S

TOPJOB® S: In various industrial applications and modern building installations, WAGO's wide and versatile range of rail-mount terminal blocks provides more than just reliable electrical connections.

[Show all products from the family](#)

Subject to changes. Please also observe the further product documentation!