

RoHS Compliant

BOMcheck.net

Similar to picture

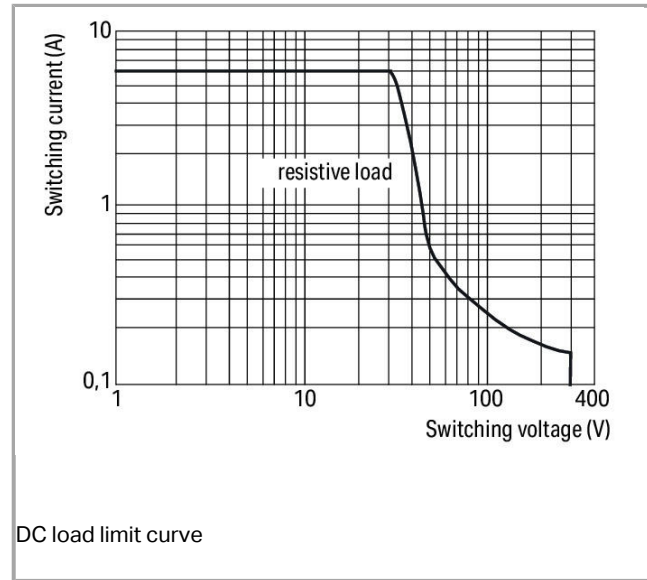
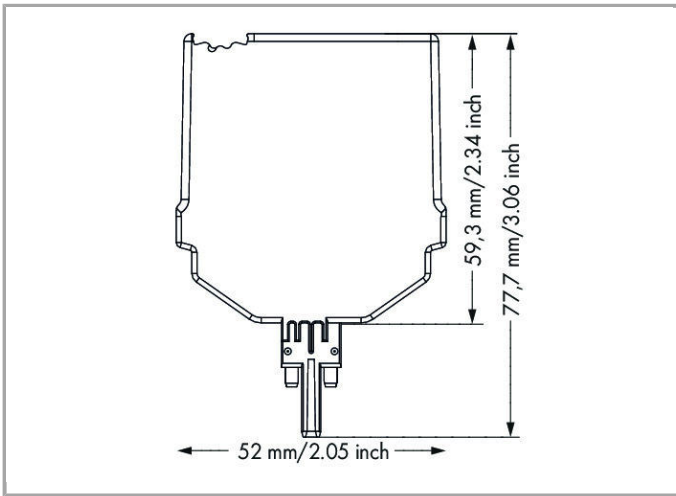

## Data

### Technical Data

#### Control circuit

Nominal input voltage $U_N$	AC/DC 24 ... 230 V
Input voltage range	$\pm 10\%$
Nominal input current at $U_N$	1.7 mA (230 V); 26.3 mA (24 V)

#### Load circuit:

Number of break contacts/switch off contacts	1
Contact material (relay)	AgSnO <sub>2</sub>
Limiting continuous current	6 A
Max. switching voltage	AC 250 V
Max. switching power (resistive)	AC 1,500 VA; DC see load limit curve
Recommended minimum load	10 V / 10 mA; 24 V / 1 mA
Min. switching current	0 $\mu$ A
Pull-in time (typ.)	8 ms
Drop-out time (typ.)	4 ms
Drop-out time	$\leq 0 \mu$ s
Electrical life (N.O.; resistive load; 23 °C)	$10 \times 10^3$ switching operations
Mechanical life (N.O.; resistive load; 23 °C)	$5 \times 10^6$ switching operations

## Signaling

Status indication	LED green
-------------------	-----------

### Safety and protection:

Rated voltage	250 V
Rated impulse voltage	4 kV
Pollution degree	2
Dielectric strength, control/load circuit (AC, 1 min)	3 kVrms
Dielectric strength open contact (AC, 1 min)	1 kVrms
Dielectric strength, channel/channel (AC, 1 min)	2.5 kV <sub>rms</sub>
Protection class	IP20

### Geometrical Data

Width	10.3 mm / 0.406 inch
Height	77.7 mm / 3.059 inch
Height from the surface	59.3 mm / 2.335 inch
Depth	52 mm / 2.047 inch

### Mechanical data

Type of mounting	Pluggable module for TOPJOB® S carrier terminal block
------------------	---

### Material Data

Flammability class per UL94	V0
Fire load	0.204 MJ
Weight	27.75

### Environmental Requirements

Pollution degree	2
Surrounding air (operating) temperature at U <sub>N</sub>	-40 ... 70 °C
Surrounding air (storage) temperature	-40 ... 85 °C
Max. operating altitude	2000 m

### Standards and specifications

Standards/specifications	EN 61010-2-201; EN 61373; EN 50121-3-2
--------------------------	--

### Commercial data





Country of origin	DE
GTIN	4055143709569















## Compatible products

## Terminal Block

	<b>Item no.: 2002-1661</b> Carrier terminal block; for disconnect; fuse or component plug; rail mount; 2-conductor; 5.2 mm wide; gray	<a href="http://www.wago.com/2002-1661">www.wago.com/2002-1661</a>
	<b>Item no.: 2002-1761</b> Carrier terminal block; for disconnect; fuse or component plug; rail mount; 3-conductor; 5.2 mm wide; gray	<a href="http://www.wago.com/2002-1761">www.wago.com/2002-1761</a>
	<b>Item no.: 2002-1861</b> Carrier terminal block; for disconnect; fuse or component plug; rail mount; 4-conductor; 5.2 mm wide; gray	<a href="http://www.wago.com/2002-1861">www.wago.com/2002-1861</a>
	<b>Item no.: 2002-1961</b> Carrier terminal block; for disconnect; fuse or component plug; with additional jumper location; rail mount; 2-conductor; 5.2 mm wide; gray	<a href="http://www.wago.com/2002-1961">www.wago.com/2002-1961</a>

## Marking accessories

	<b>Item no.: 2009-110</b> Marking strips; on reel; not stretchable; plain; snap-on type	<a href="http://www.wago.com/2009-110">www.wago.com/2009-110</a>
	<b>Item no.: 2009-115</b> WMB-Inline; for smartPRINTER; on reel; stretchable 5 - 5.2 mm; plain; snap-on type	<a href="http://www.wago.com/2009-115">www.wago.com/2009-115</a>
	<b>Item no.: 2009-115/000-002</b> WMB-Inline; for Smart Printer; on reel; stretchable 5 - 5.2 mm; plain; snap-on type	<a href="http://www.wago.com/2009-115/000-002">www.wago.com/2009-115/000-002</a>
	<b>Item no.: 2009-115/000-006</b> WMB-Inline; for smartPRINTER; on reel; stretchable 5 - 5.2 mm; plain; snap-on type	<a href="http://www.wago.com/2009-115/000-006">www.wago.com/2009-115/000-006</a>
	<b>Item no.: 2009-115/000-007</b> WMB-Inline; for smartPRINTER; on reel; stretchable 5 - 5.2 mm; plain; snap-on type	<a href="http://www.wago.com/2009-115/000-007">www.wago.com/2009-115/000-007</a>
	<b>Item no.: 2009-115/000-012</b> WMB-Inline; for smartPRINTER; on reel; stretchable 5 - 5.2 mm; plain; snap-on type	<a href="http://www.wago.com/2009-115/000-012">www.wago.com/2009-115/000-012</a>
	<b>Item no.: 2009-115/000-017</b> WMB-Inline; for smartPRINTER; on reel; stretchable 5 - 5.2 mm; plain; snap-on type	<a href="http://www.wago.com/2009-115/000-017">www.wago.com/2009-115/000-017</a>
	<b>Item no.: 2009-115/000-023</b> WMB-Inline; for smartPRINTER; on reel; stretchable 5 - 5.2 mm; plain; snap-on type	<a href="http://www.wago.com/2009-115/000-023">www.wago.com/2009-115/000-023</a>
	<b>Item no.: 2009-115/000-024</b> WMB-Inline; for smartPRINTER; on reel; stretchable 5 - 5.2 mm; plain; snap-on type	<a href="http://www.wago.com/2009-115/000-024">www.wago.com/2009-115/000-024</a>

	<p><b>Item no.: 793-501</b> WMB marking card; as card; not stretchable; plain; snap-on type</p>	<a href="http://www.wago.com/793-501">www.wago.com/793-501</a>
	<p><b>Item no.: 793-501/000-002</b> WMB marking card; as card; not stretchable; plain; snap-on type</p>	<a href="http://www.wago.com/793-501/000-002">www.wago.com/793-501/000-002</a>
	<p><b>Item no.: 793-501/000-005</b> WMB marking card; as card; not stretchable; plain; snap-on type</p>	<a href="http://www.wago.com/793-501/000-005">www.wago.com/793-501/000-005</a>
	<p><b>Item no.: 793-501/000-006</b> WMB marking card; as card; not stretchable; plain; snap-on type</p>	<a href="http://www.wago.com/793-501/000-006">www.wago.com/793-501/000-006</a>
	<p><b>Item no.: 793-501/000-007</b> WMB marking card; as card; not stretchable; plain; snap-on type</p>	<a href="http://www.wago.com/793-501/000-007">www.wago.com/793-501/000-007</a>
	<p><b>Item no.: 793-501/000-012</b> WMB marking card; as card; not stretchable; plain; snap-on type</p>	<a href="http://www.wago.com/793-501/000-012">www.wago.com/793-501/000-012</a>
	<p><b>Item no.: 793-501/000-017</b> WMB marking card; as card; not stretchable; plain; snap-on type</p>	<a href="http://www.wago.com/793-501/000-017">www.wago.com/793-501/000-017</a>
	<p><b>Item no.: 793-501/000-023</b> WMB marking card; as card; not stretchable; plain; snap-on type</p>	<a href="http://www.wago.com/793-501/000-023">www.wago.com/793-501/000-023</a>
	<p><b>Item no.: 793-501/000-024</b> WMB marking card; as card; not stretchable; plain; snap-on type</p>	<a href="http://www.wago.com/793-501/000-024">www.wago.com/793-501/000-024</a>
	<p><b>Item no.: 793-5501</b> WMB marking card; as card; for terminal block width 5 - 17.5 mm; stretchable 5 - 5.2 mm; plain; snap-on type</p>	<a href="http://www.wago.com/793-5501">www.wago.com/793-5501</a>
	<p><b>Item no.: 793-5501/000-002</b> WMB marking card; as card; for terminal block width 5 - 17.5 mm; stretchable 5 - 5.2 mm; plain; snap-on type</p>	<a href="http://www.wago.com/793-5501/000-002">www.wago.com/793-5501/000-002</a>
	<p><b>Item no.: 793-5501/000-005</b> WMB marking card; as card; stretchable 5 - 5.2 mm; plain; snap-on type</p>	<a href="http://www.wago.com/793-5501/000-005">www.wago.com/793-5501/000-005</a>
	<p><b>Item no.: 793-5501/000-006</b> WMB marking card; as card; stretchable 5 - 5.2 mm; plain; snap-on type</p>	<a href="http://www.wago.com/793-5501/000-006">www.wago.com/793-5501/000-006</a>
	<p><b>Item no.: 793-5501/000-007</b> WMB marking card; as card; stretchable 5 - 5.2 mm; plain; snap-on type</p>	<a href="http://www.wago.com/793-5501/000-007">www.wago.com/793-5501/000-007</a>
	<p><b>Item no.: 793-5501/000-012</b> WMB marking card; as card; stretchable 5 - 5.2 mm; plain; snap-on type</p>	<a href="http://www.wago.com/793-5501/000-012">www.wago.com/793-5501/000-012</a>



**Item no.: 793-5501/000-014**  
WMB marking card; as card; stretchable 5 - 5.2 mm; plain; snap-on type

[www.wago.com/793-5501/000-014](http://www.wago.com/793-5501/000-014)



**Item no.: 793-5501/000-017**  
WMB marking card; as card; stretchable 5 - 5.2 mm; plain; snap-on type

[www.wago.com/793-5501/000-017](http://www.wago.com/793-5501/000-017)



**Item no.: 793-5501/000-023**  
WMB marking card; as card; stretchable 5 - 5.2 mm; plain; snap-on type

[www.wago.com/793-5501/000-023](http://www.wago.com/793-5501/000-023)



**Item no.: 793-5501/000-024**  
WMB marking card; as card; stretchable 5 - 5.2 mm; plain; snap-on type

[www.wago.com/793-5501/000-024](http://www.wago.com/793-5501/000-024)

### End plate

**Item no.: 2002-1691**  
TOPJOB®S end/intermediate plate; for 2002-16xx series terminal blocks; 1.0 mm wide; gray

[www.wago.com/2002-1691](http://www.wago.com/2002-1691)

**Item no.: 2002-1692**  
TOPJOB®S end/intermediate plate; for 2002-16xx series terminal blocks; 1.0 mm wide; orange

[www.wago.com/2002-1692](http://www.wago.com/2002-1692)

**Item no.: 2002-1791**  
TOPJOB®S end/intermediate plate; for 2002-17xx series terminal blocks; 1.0 mm wide; gray

[www.wago.com/2002-1791](http://www.wago.com/2002-1791)

**Item no.: 2002-1792**  
TOPJOB®S end/intermediate plate; for 2002-17xx series terminal blocks; 1.0 mm wide; orange

[www.wago.com/2002-1792](http://www.wago.com/2002-1792)

**Item no.: 2002-1891**  
TOPJOB®S end/intermediate plate; for 2002-18xx series terminal blocks; 1.0 mm wide; gray

[www.wago.com/2002-1891](http://www.wago.com/2002-1891)

**Item no.: 2002-1892**  
TOPJOB®S end/intermediate plate; for 2002-18xx series terminal blocks; 1.0 mm wide; orange

[www.wago.com/2002-1892](http://www.wago.com/2002-1892)

### Downloads

#### Documentation

##### Additional Information

Disposal; Electrical and electronic equipment, Packaging	V 1.0.0 10-Oct-2018	pdf 265.8 kB	Download
--	------------------------	-----------------	----------

### CAD files

#### CAD data

3D Download 2042-3859	URL	Download
-----------------------	-----	----------



Subject to changes.

---

WAGO Corporation  
Germantown, WI 53022  
Phone: 1-800-DIN-RAIL (346-7245) | Fax: (262) 255-6222  
Email: [info.us@wago.com](mailto:info.us@wago.com) | Web: [www.wago.com](http://www.wago.com)

Do you have any questions about our products?  
We are always happy to take your call at {0}.