

Toggle Switches Miniature

multicomp PRO

**RoHS
Compliant**

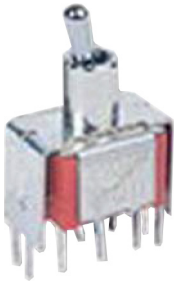

Specifications

Contact Rating	: Dependent upon contact material
Mechanical Life	: 40,000 make and break cycles
Max. Contact Resistance	: 10 mΩ
Initial voltage	: 2V DC to 4V DC
Current	: 10mA for both silver and gold plated contacts
Min. Insulation Resistance	: 1,000MΩ
Dielectric Strength	: 1,000Vrms at sea level
Operating Temperature	: -30°C to 85°C

Materials

Case	: Diallylphthalate (DAP) (UL94v-0)
Actuator	: Brass, chrome plated
Bushing	: Brass, nickel plated
Housing	: Stainless steel
Switch support	: Brass, tin plated
Terminal/contact	: Silver or gold plated

Switch Function

Number of Poles	UL/CSA Model Numbers	Model Number	Switch Function			Connected Terminals/Schematic		
			Position 1	Position 2	Position 3	Position 1	Position 2	Position 3
SP	Q1111	1MS1	On	None	ON	2 to 3	N/A	2 to 1
	Q1112	1MS2			MOM			
	Q1113	1MS3	MOM	Off	ON		Open	
	Q1114	1MS4			MOM			
	Q1115	1MS5			On			
DP	Q1121	1MD1	On	None	ON	2 to 3, 5 to 6	N/A	2 to 1, 5 to 4
	Q1122	1MD2			MOM			
	Q1123	1MD3	MOM	Off	ON		Open	
	Q1124	1MD4			MOM			
	Q1125	1MD5			On			
DP	Q1126	1MD6	On	On	On	2 to 3, 5 to 6	2 to 3, 5 to 4	2 to 1, 5 to 4
	Q1127	1MD7	MOM		MOM			
	Q1128	1MD8	On	None	On	2 to 3, 5 to 6, 8 to 9	N/A	2 to 1, 5 to 4, 8 to 7
Q1131	1M31	MOM						
Q1132	1M32	MOM						
Q1133	1M33	On						
3P	Q1134	1M34	MOM	Off	On		Open	
	Q1135	1M35			MOM			

Newark.com/multicomp-pro
Farnell.com/multicomp-pro
Element14.com/multicomp-pro

multicomp PRO

Toggle Switches

Miniature

Number of Poles	UL/CSA Model Numbers	Model Number	Switch Function			Connected Terminals/Schematic		
			Position 1	Position 2	Position 3	Position 1	Position 2	Position 3
4P	Q1141	1M41	On	None	On	2 to 3, 5 to 6, 8 to 9, 11 to 12	-	2 to 1, 5 to 4, 8 to 7, 11 to 10
	Q1142	1M42			MOM		-	
	Q1143	1M43	On	-				
	Q1144	1M44	MOM	Off	On		-	
	Q1145	1M45	MOM		-			
	Q1146	1M46	On	On	On	2 to 3, 5 to 6, 8 to 9, 11 to 12	-	2 to 3, 5 to 4, 8 to 9, 11 to 10
	Q1147	1M47	MOM		MOM		2 to 3, 5 to 4, 8 to 9, 11 to 10	
Q1148	1M48	On	MOM		2 to 3, 5 to 4, 8 to 9, 11 to 10			

Pole Options

SPDT

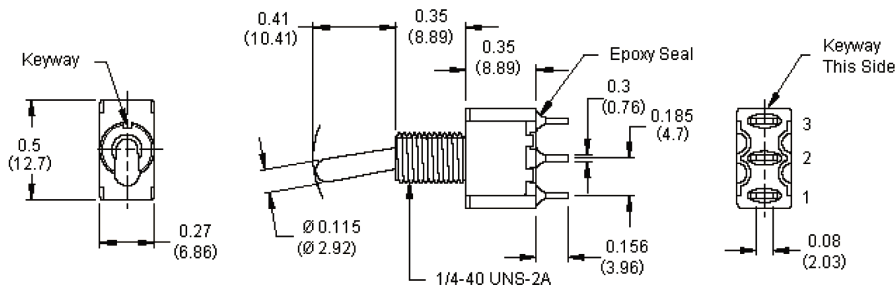

DPDT

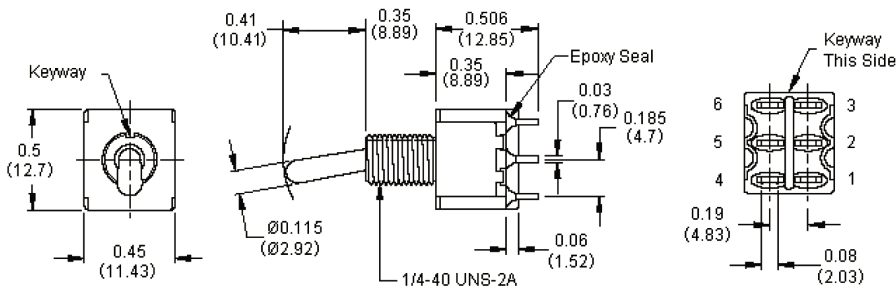

Dimensions : Inches (Millimetres)

Toggle Switches

Miniature

Pole Options

3PDT

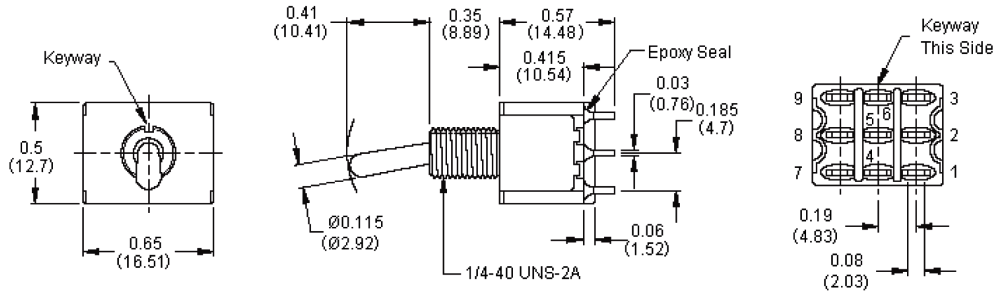

4PDT

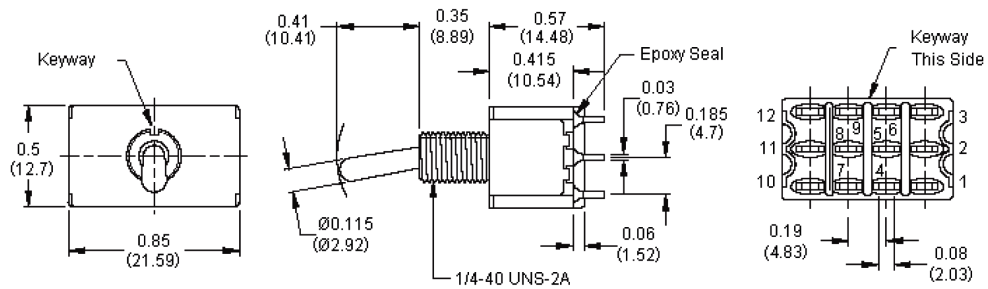

Single Pole, 3 Position

Model No.			
1M46	ON	ON	ON
Term. Comm.	2 to 3, 5 to 6 8 to 9, 11 to 12	2 to 3, 5 to 4 8 to 9, 11 to 10	2 to 1, 5 to 4 8 to 7, 11 to 10

Double Pole, 3 Position

Model No.			
1M46	ON	ON	ON
Term. Comm.	2 to 3, 5 to 6 8 to 9, 11 to 12	2 to 3, 5 to 4 8 to 9, 11 to 10	2 to 1, 5 to 4 8 to 7, 11 to 10

Dimensions : Inches (Millimetres)

Toggle Switches Miniature

multicomp PRO

3-Way Wiring Diagram Schematics

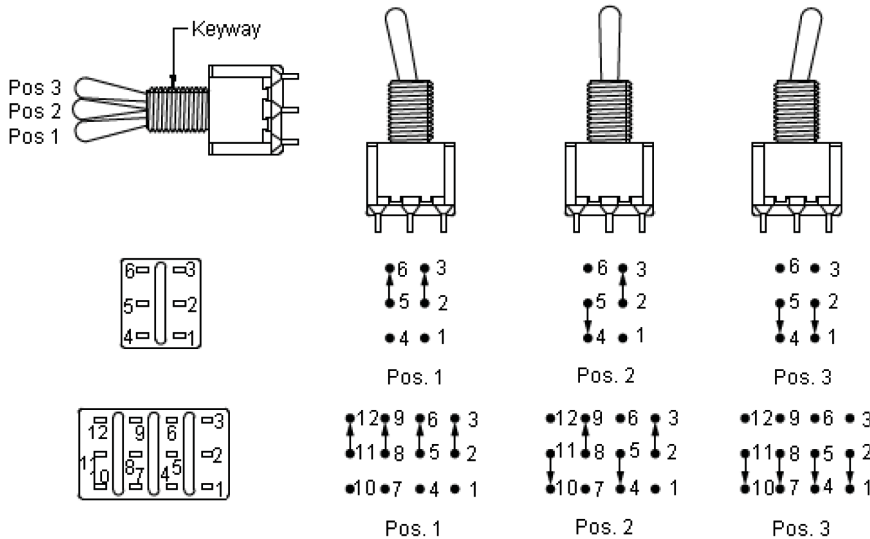

Actuator Options

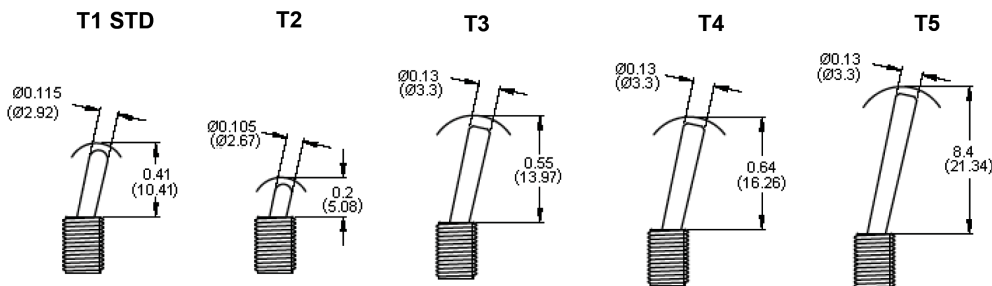

Note: T1 to T5 Actuator shown with standard B1 bushing ;
add. 07 (1.78) for B3 Bushing ;
Subtract 0.02 (0.51) for B6 Bushing ;
Std for M1, M2 Terminal sub 0.016 (0.4) for M6, M7, VSX

T6 Flatted with anti-rotation

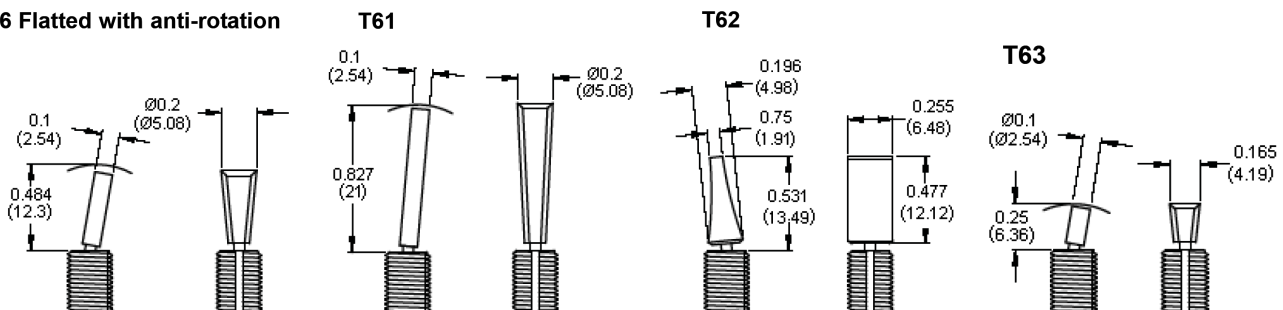

Note: T6, T6-1, T6-2, T63 use with B11, B12, B15, B16 bushing only

Dimensions : Inches (Millimetres)

Newark.com/multicomp-pro
Farnell.com/multicomp-pro
Element14.com/multicomp-pro

multicomp PRO

Toggle Switches Miniature

multicomp PRO

T7

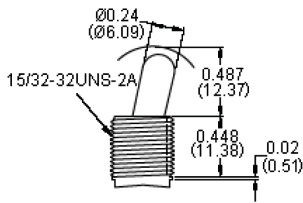

Use with B13 bushing
Use with B18, B20 the lever is anti-rotation and the size of lever is 13mm

T8

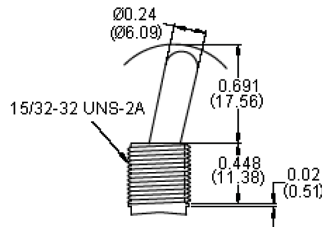

Use with B13 bushing
Use with B18, B20 the lever is anti-rotation and the size of lever is 18mm

T9

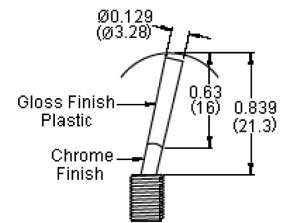

B1/B2 bushing std
with black and red colour only (std).

TA Plastic Black

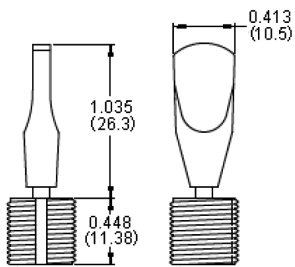

Use with B18 bushing only

T11

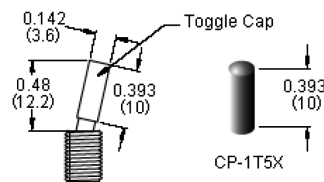

Note: T11 Actuator shown with standard B1 bushing;
Add 0.07 (1.78) for B3 bushing;
Subtract 0.02 (0.51) for B6 bushing.
Std for M1.M2 Terminal sub. 0.016 (0.4) for M6.M7.VSX

Plastic No. Colour

No.	Colour
1	White
2	Black (Std)
3	Red
4	Orange
5	Yellow
6	Green
7	Blue
8	Brown
9	Grey

TL1B25

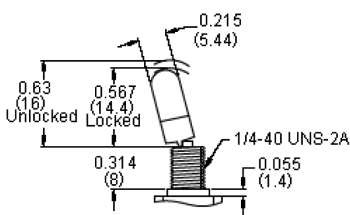

TL2B25

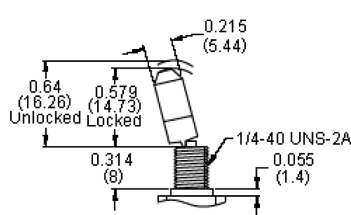

TL3B25

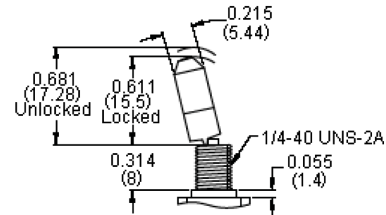

Dimensions : Inches (Millimetres)

Newark.com/multicomp-pro
Farnell.com/multicomp-pro
Element14.com/multicomp-pro

multicomp PRO

Toggle Switches Miniature

multicomp PRO

**B1 THD STD
B2 NON-THD**

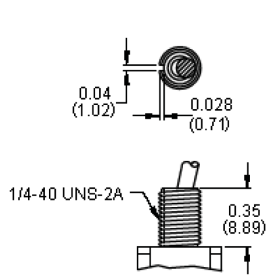

**B3 THD
B4 NON-THD**

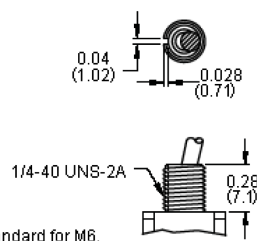

B4 is standard for M6, M7 and VS2 to 5 termination options.

B5 High Torque

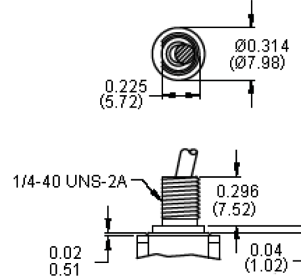

B6 High Torque

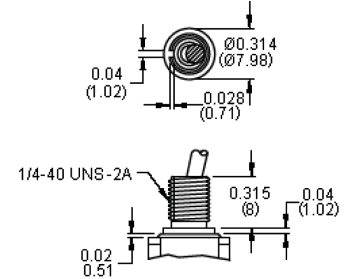

B7 Thd STD

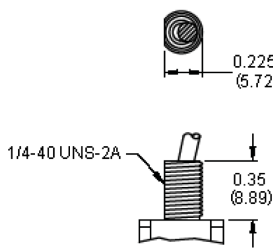

B8 Metric Thd

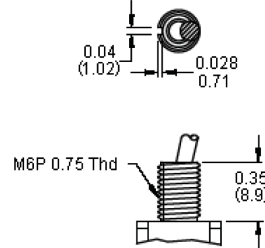

B9 Splash Proof

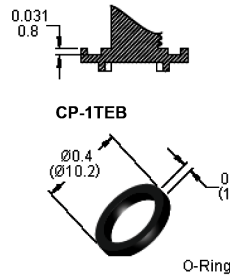
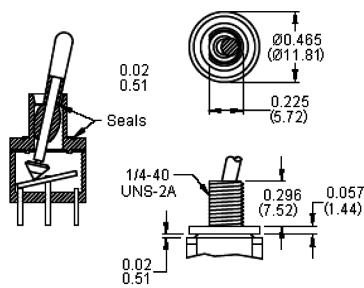

**B11 THD STD
B12 NON-THD**

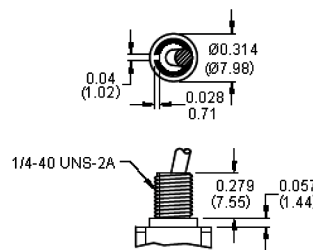

**B15 THD STD
B16 NON-THD**

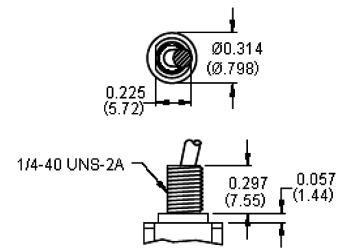

B17

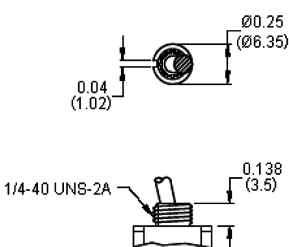

B13

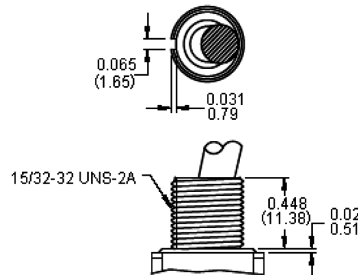

Use with T7, T8 actuators only

B13 Bear strength from top of actuator up to 10 kg aside up to 15 kg

Dimensions : Inches (Millimetres)

Newark.com/multicomp-pro
Farnell.com/multicomp-pro
Element14.com/multicomp-pro

multicomp PRO

Toggle Switches Miniature

multicomp PRO

B14 Splash Proof

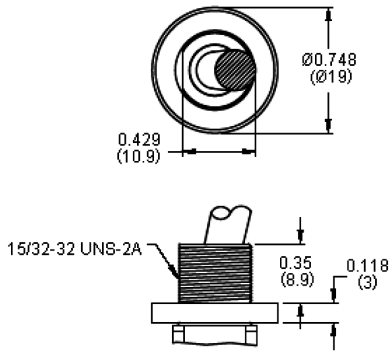

B18

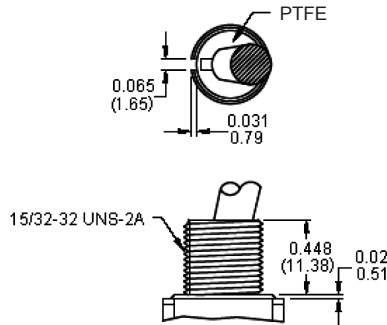

B20

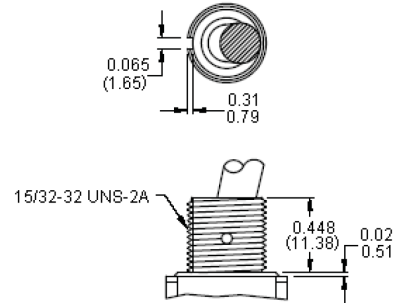

Use with T7, T8 and T10 actuators only with plastic (PTFE) Insert

Use with T7, T8 and T10 actuators only B18, B20 Bear Strength from top of actuator up to 20kg aside up to 15kg

Panel Mounting

1/4 In Bushing

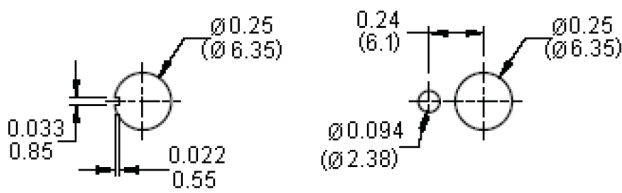

Metric Bushing

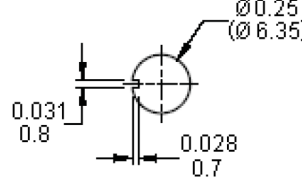

15/32 In Bushing

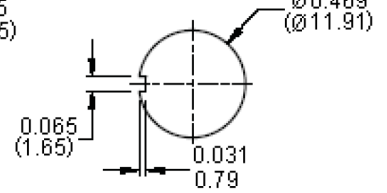

1/4 In Bushing

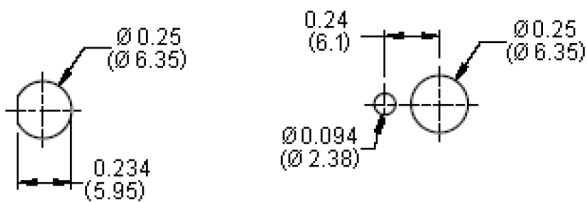

Metric Bushing

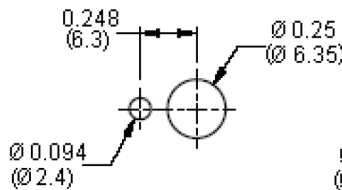

15/32 In Bushing

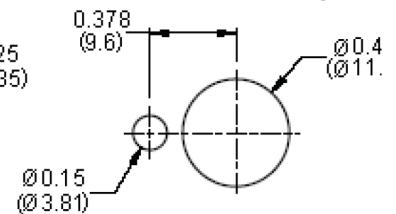

Termination Options

M1 Solder Lug

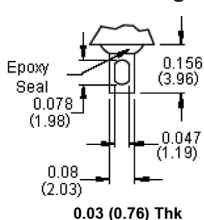

M2 PC Thru-Hole

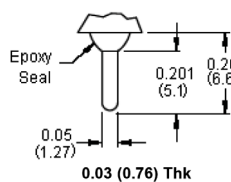

M5 Wire Wrap

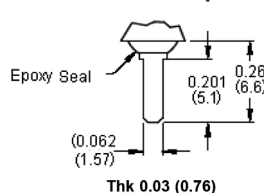

M3 Quick Connect

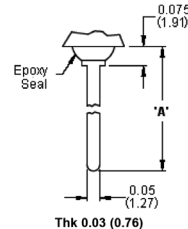

Option Code	Dimension 'A'
M5-1	0.736 (18.7)
M5-2	0.953 (24.2)
M5-3	0.415 (10.55)
M5-4	1.062 (26.97)

Dimensions : Inches (Millimetres)

Newark.com/multicomp-pro
Farnell.com/multicomp-pro
Element14.com/multicomp-pro

multicomp PRO

Toggle Switches Miniature

multicomp PRO

Other Termination Options

- M6 Right Angle P.C. Mount
- M7 Right Angle P.C. Mount
- VS2 Vertical Bracket P.C. Mount
- VS3 Vertical Bracket P.C. Mount
- VS5 Vertical Bracket P.C. Mount

RE Mating Quick Connector
Amp P/N 60900-1

M6

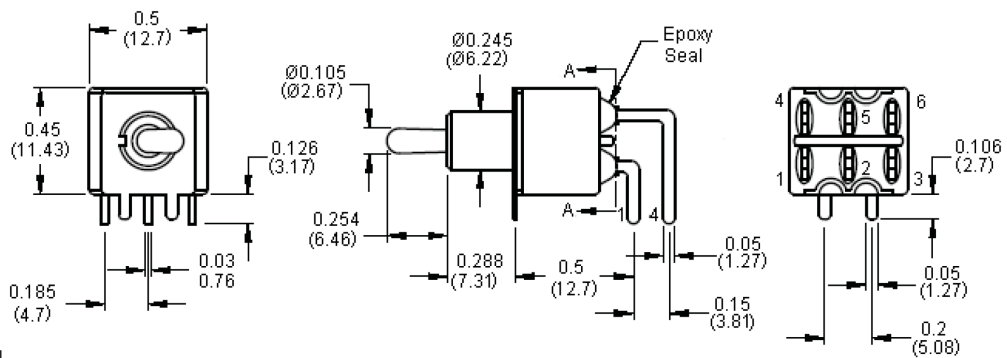

P. C. Mounting

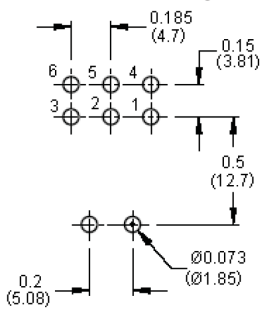

Section A-A
Term. Nos. for
Reference Only

SNAP-IN Termination Options

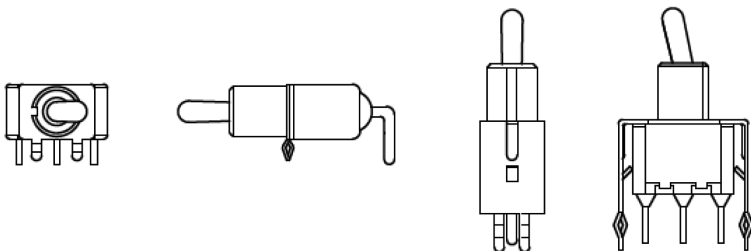

Dimensions : Inches (Millimetres)

Newark.com/multicomp-pro
Farnell.com/multicomp-pro
Element14.com/multicomp-pro

multicomp PRO

Toggle Switches Miniature

multicomp PRO

Hardware

1/4 Nuts HDW2

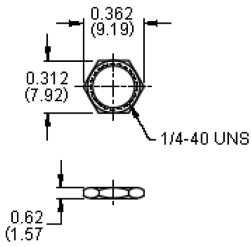

Supplied Standard with
B1, B3, B5, B6 and B9 Options

Dress Nut HDW3

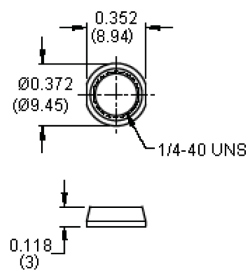

Metric Nut HDW6

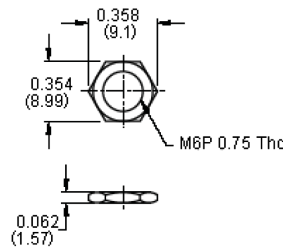

Supplied Standard with
B8 metric bushing

Lock Washer HDW11

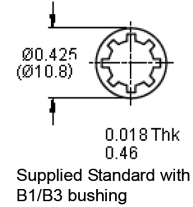

Supplied Standard with
B1/B3 bushing

Optional Rubber Hood Sealing

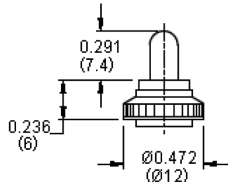

K1 = Metric
E1 = Inch (Std.)
for actuator T1, T2 and
B1, B3, B5, B6 Bushing only

15/32 Nuts HDW4

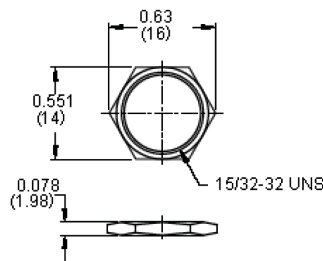

Supplied standard with B13 bushing

Lock Washer HDW12

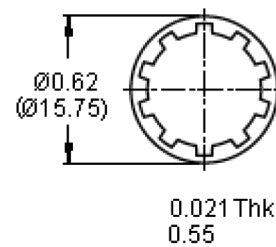

Supplied standard with B13 bushing

HDW15

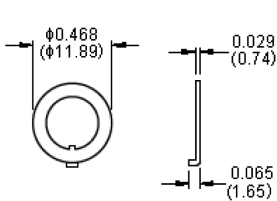

Locking ring supplied standard

HDW16

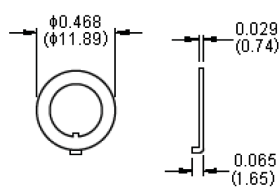

Locking ring supplied with
B5 bushing

HDW17

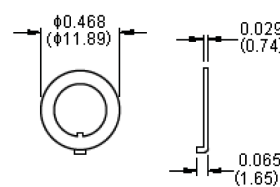

Locking ring supplied with
B13, B18, B20 bushing

HDW17

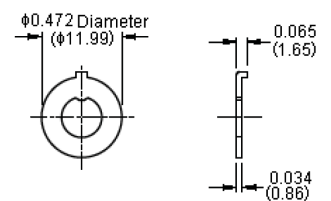

Locking ring supplied with
B8 bushing

HDW19

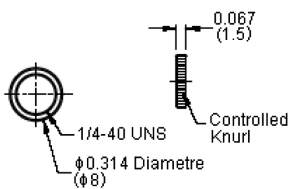

Nu-1M18

HDW20

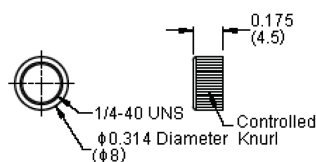

Nu-1M24

Optional Toggle Cap

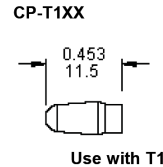

Cap Colour

No.	Colour
1	White
2	Black (Std)
3	Red
5	Yellow
6	Green
7	Blue
9	Grey

Dimensions : Inches (Millimetres)

Newark.com/multicomp-pro
Farnell.com/multicomp-pro
Element14.com/multicomp-pro

multicomp PRO

Toggle Switches

Miniature

Contact Material Options

	Contact Plating	Terminal Plating	Ratings
Q	Silver	Q = Silver	5 Amperes with resistant load at 120V AC or 28V DC 2 Amps with resistant load at 250V AC
S		S = Silver, pure-tin	
C	Gold over Silver	C = Gold over silver	
K		K = Gold over silver, pure-tin	
R	Gold	R = Gold	0.4 Volt-Amperes (VA) maximum at (20 V maximum (AC or DC)
G		G = Gold, pure-tin	

Soldering Process

Manual Soldering : Use soldering iron of 30 watts, controlled at 350°C
approximately 5 seconds while applying solder

Wave Soldering : Recommended soldering temperature : 260 ±5°C
Duration of solder immersion : Maximum 5 ±1 seconds. (PCB is 1.6 mm in thickness)

Soldering : Vapour Phase

Part Number Table

Description	Part Number	Description	Part Number
Switch, PCB, DPDT, ON-MOM	1MD2T2B4VS3RE	Switch, SOLDER TAG, DPDT, ON-MOM	1MD2T1B5M1QE
Switch, PCB, DPDT, MOM-OFF-MOM	1MD4T2B4VS3RE	Switch, SOLDER TAG, DPDT, MOM-OFF-MOM	1MD4T1B5M1QE
Switch, PCB, DPDT, ON-OFF-ON	1MD3T2B4VS3RE	Switch, SOLDER TAG, DPDT, ON-OFF-MOM	1MD5T1B5M1QE
Switch, PCB, DPDT, ON-OFF-MOM	1MD5T2B4VS3RE	Switch, SOLDER TAG, DPDT, ON-ON-ON	1MD6T1B5M1QE
Switch, PCB, DPDT, ON-ON-ON	1MD6T2B4VS3RE	Switch, SOLDER TAG, 3PDT, ON-MOM	1M32T1B5M1QE
Switch, PCB, SPDT, ON-MOM	1MS2T2B4M6RE	Switch, SOLDER TAG, 3PDT, ON-ON	1M31T1B5M1QE
Switch, PCB, SPDT, ON-OFF-MOM	1MS5T2B4M6RE	Switch, SOLDER TAG, 3PDT, MOM-OFF-MOM	1M34T1B5M1QE
Switch, PCB, DPDT, ON-MOM	1MD2T2B4M6RE	Switch, SOLDER TAG, 3PDT, ON-OFF-ON	1M33T1B5M1QE
Switch, PCB, DPDT, MOM-OFF-MOM	1MD4T2B4M6RE	Switch, SOLDER TAG, 3PDT, ON-OFF-MOM	1M35T1B5M1QE
Switch, PCB, DPDT, ON-OFF-MOM	1MD5T2B4M6RE	Switch, SOLDER TAG, 4PDT, ON-MOM	1M42T1B5M1QE
Switch, PCB, DPDT, ON-ON-ON	1MD6T2B4M6RE	Switch, SOLDER TAG, 4PDT, ON-ON	1M41T1B5M1QE
Switch, PCB, SPDT, ON-MOM	1MS2T2B4M7RE	Switch, SOLDER TAG, 4PDT, MOM-OFF-MOM	1M44T1B5M1QE
Switch, PCB, SPDT, MOM-OFF-MOM	1MS4T2B4M7RE	Switch, SOLDER TAG, 4PDT, ON-OFF-ON	1M43T1B5M1QE
Switch, PCB, SPDT, ON-OFF-MOM	1MS5T2B4M7RE	Switch, SOLDER TAG, 4PDT, ON-OFF-MOM	1M45T1B5M1QE
Switch, PCB, DPDT, ON-MOM	1MD2T2B4M7RE	Switch, SOLDER TAG, 4PDT, ON-ON-ON	1M46T1B5M1QE
Switch, PCB, DPDT, MOM-OFF-MOM	1MD4T2B4M7RE	Switch, PCB SPDT VERT.	1MS5T2B4V2RE.
Switch, PCB, DPDT, ON-OFF-ON	1MD3T2B4M7RE	Switch, SPDT	1MS3T1B5M1QE.
Switch, PCB, DPDT, ON-OFF-MOM	1MD5T2B4M7RE	Switch, DPDT	1MD3T1B5M1QE.
Switch, PCB, DPDT, ON-ON-ON	1MD6T2B4M7RE	Switch, PCB, SPDT, VERT	1MS1T2B4V2RE
Switch, SOLDER TAG, SPDT, ON-MOM	1MS2T1B5M1QE	Switch, PCB, SPDT, VERT	1MS3T2B4V2RE
Switch, SOLDER TAG, SPDT, MOM-OFF-MOM	1MS4T1B5M1QE	Switch, PCB, SPDT, VERT	1MS2T2B4V2RE
Switch, SOLDER TAG, SPDT, ON-OFF-MOM	1MS5T1B5M1QE	Switch, PCB, SPDT, VERT	1MS4T2B4V2RE

Toggle Switches Miniature

multicomp PRO

Description	Part Number	Description	Part Number
Switch, PCB, SPDT, VERT	1MS5T2B4V2RE	Switch, PCB, DPDT, HORIZ	1MD3T2B4M6RE
Switch, PCB, DPDT, VERT	1MD1T2B4V3RE	Switch, PCB, SPDT, HORIZ	1MS1T2B4M7RE
Switch, PCB, SPDT, HORIZ	1MS1T2B4M6RE	Switch, PCB, SPDT, HORIZ	1MS3T2B4M7RE
Switch, PCB, SPDT, HORIZ	1MS3T2B4M6RE	Switch, PCB, DPDT, HORIZ	1MD1T2B4M7RE
Switch, PCB, SPDT, HORIZ	1MS4T2B4M6RE	Switch, SPDT, 2.0A, 250V	1MS1T1B5M1QE
Switch, PCB, DPDT, HORIZ	1MD1T2B4M6RE	Switch, SPDT	1MS3T1B5M1QE

Part Number Explanation

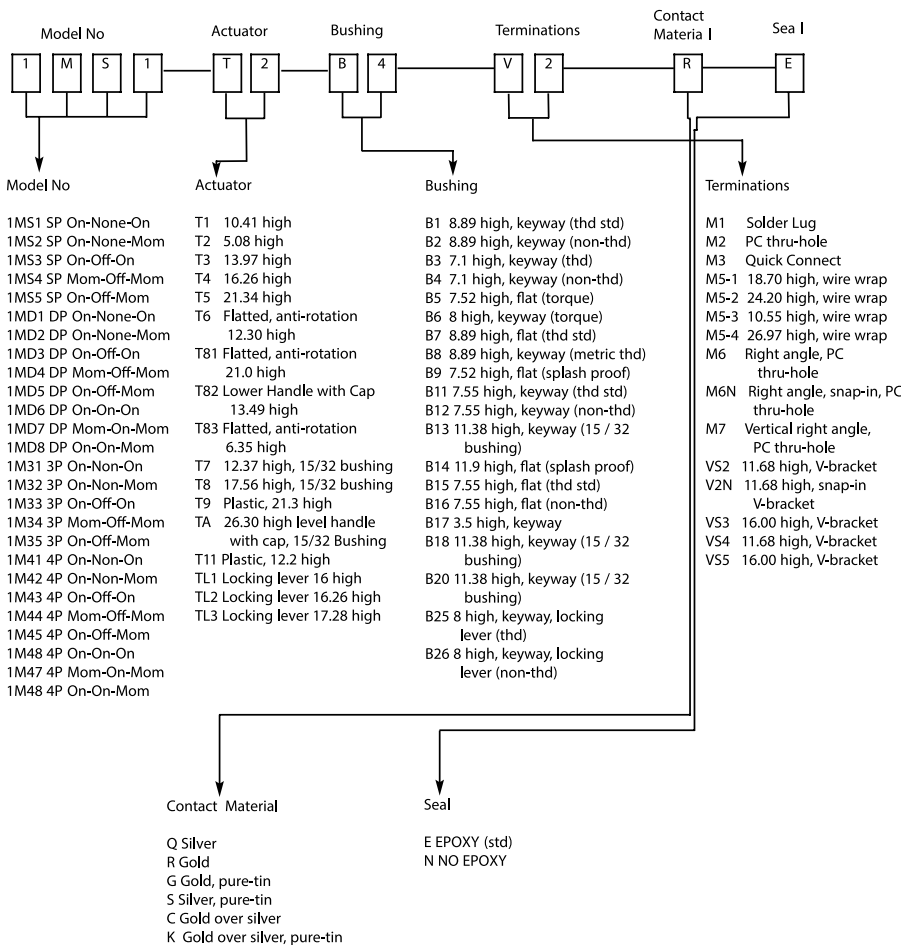

Important Notice : This data sheet and its contents (the "Information") belong to the members of the AVNET group of companies (the "Group") or are licensed to it. No licence is granted for the use of it other than for information purposes in connection with the products to which it relates. No licence of any intellectual property rights is granted. The Information is subject to change without notice and replaces all data sheets previously supplied. The Information supplied is believed to be accurate but the Group assumes no responsibility for its accuracy or completeness, any error in or omission from it or for any use made of it. Users of this data sheet should check for themselves the Information and the suitability of the products for their purpose and not make any assumptions based on information included or omitted. Liability for loss or damage resulting from any reliance on the Information or use of it (including liability resulting from negligence or where the Group was aware of the possibility of such loss or damage arising) is excluded. This will not operate to limit or restrict the Group's liability for death or personal injury resulting from its negligence. Multicomp Pro is the registered trademark of Premier Farnell Limited 2019.

Newark.com/multicomp-pro
Farnell.com/multicomp-pro
Element14.com/multicomp-pro

multicomp PRO