

OMNIMATE Signal - series BC/SC 3.81 SC 3.81/06/90G 3.2SN GN BX

Weidmüller Interface GmbH & Co. KG
Klingenbergstraße 16
D-32758 Detmold
Germany
Fon: +49 5231 14-0
Fax: +49 5231 14-292083
www.weidmueller.com

Product image

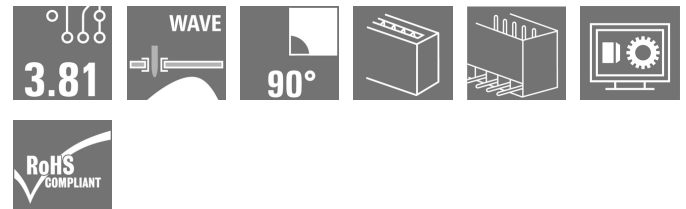
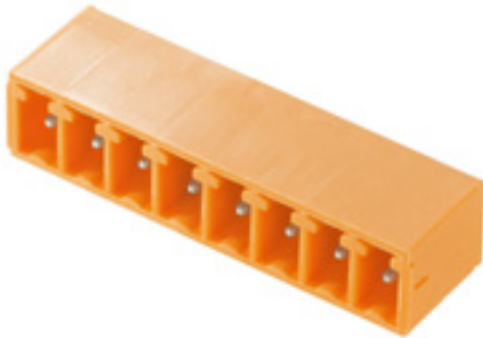

Similar to illustration

The SC pin header has a parallel (recumbent) plugging direction in relation to the PCB. It is available in closed (G) and screw flange (F) versions.

Weidmüller's 3.81-mm-pitch (0.15 inch) plug-in connectors are compatible with the layouts of standard connectors. They support a flood-light display and offer space for labelling and coding.

General ordering data

Type	SC 3.81/06/90G 3.2SN GN BX
Order No.	1793280000
Version	PCB plug-in connector, male header, closed side, THT solder connection, 3.81 mm, No. of poles: 6, 90°, Solder pin length (l): 3.2 mm, tinned, Pale green, Box
GTIN (EAN)	4032248227754
Qty.	50 pc(s).
Product data	IEC: 320 V / 17.5 A UL: 300 V / 10 A
Packaging	Box

**OMNIMATE Signal - series BC/SC 3.81
SC 3.81/06/90G 3.2SN GN BX**

Weidmüller Interface GmbH & Co. KG
 Klingenbergstraße 16
 D-32758 Detmold
 Germany
 Fon: +49 5231 14-0
 Fax: +49 5231 14-292083
 www.weidmueller.com

Technical data**Dimensions and weights**

Width	24.26 mm	Width (inches)	0.955 inch
Height	10.3 mm	Height (inches)	0.406 inch
Height of lowest version	7.1 mm	Depth	9.2 mm
Depth (inches)	0.362 inch	Net weight	1.7 g

System specifications

Product family	OMNIMATE Signal - series BC/SC 3.81	Type of connection	Board connection
Mounting onto the PCB	THT solder connection	Pitch in mm (P)	3.81 mm
Pitch in inches (P)	0.15 inch	Outgoing elbow	90°
No. of poles	6	Number of solder pins per pole	1
Solder pin length (l)	3.2 mm	Solder pin length tolerance	0 / -0,02 mm
Tolerance of solder pin position	± 0.1 mm	Solder pin dimensions	d = 1.0 mm, Octagonal
Solder pin dimensions = d tolerance	0 / -0,03 mm	Solder eyelet hole diameter (D)	1.2 mm
Solder eyelet hole diameter tolerance (D)+	0,1 mm	L1 in mm	19.05 mm
L1 in inches	0.75 inch	Number of rows	1
Pin series quantity	1	Touch-safe protection acc. to DIN VDE 57 106	Safe from finger touch
Touch-safe protection acc. to DIN VDE 0470	IP 20	Volume resistance	6.00 mΩ
Can be coded	Yes	Plugging cycles	25
Plugging force/pole, max.	7 N	Pulling force/pole, max.	5 N

Material data

Insulating material	PA GF	Colour	Pale green
Colour chart (similar)	RAL 6021	Insulating material group	II
CTI	≥ 550	Insulation resistance	≥ 10 ⁸ Ω
UL 94 flammability rating	V-0	Contact material	Copper alloy
Contact surface	tinned	Storage temperature, min.	-25 °C
Storage temperature, max.	55 °C	Max. relative humidity during storage	80 %
Operating temperature, min.	-50 °C	Operating temperature, max.	120 °C
Temperature range, installation, min.	-25 °C	Temperature range, installation, max.	120 °C

Rated data acc. to IEC

tested acc. to standard	IEC 60664-1, IEC 61984	Rated current, min. no. of poles (Tu=20°C)	17.5 A
Rated current, max. no. of poles (Tu=20°C)	17.5 A	Rated current, min. no. of poles (Tu=40°C)	17.5 A
Rated current, max. no. of poles (Tu=40°C)	16.3 A	Rated voltage for surge voltage class / pollution degree II/2	320 V
Rated voltage for surge voltage class / pollution degree III/2	160 V	Rated voltage for surge voltage class / pollution degree III/3	160 V
Rated impulse voltage for surge voltage class/ pollution degree II/2	2.5 kV	Rated impulse voltage for surge voltage class/ pollution degree III/2	2.5 kV
Rated impulse voltage for surge voltage class/ contamination degree III/3	2.5 kV	Short-time withstand current resistance	3 x 1s with 76 A

Data sheet

**OMNIMATE Signal - series BC/SC 3.81
SC 3.81/06/90G 3.2SN GN BX**

Weidmüller Interface GmbH & Co. KG
Klingenbergstraße 16
D-32758 Detmold
Germany
Fon: +49 5231 14-0
Fax: +49 5231 14-292083
www.weidmueller.com

Technical data

Rated data acc. to CSA

Institute (CSA)		Certificate No. (CSA)	200039-1121690
Rated voltage (Use group B / CSA)	300 V	Rated current (Use group B / CSA)	8 A
Reference to approval values	Specifications are maximum values, details - see approval certificate.		

Rated data acc. to UL 1059

Institute (cURus)		Certificate No. (cURus)	E60693
Rated voltage (Use group B / UL 1059)	300 V	Rated voltage (Use group D / UL 1059)	300 V
Rated current (Use group B / UL 1059)	10 A	Rated current (Use group D / UL 1059)	10 A
Reference to approval values	Specifications are maximum values, details - see approval certificate.		

Packaging

Packaging	Box	VPE length	44 mm
VPE width	60 mm	VPE height	76 mm

Classifications

ETIM 3.0	EC001284	ETIM 4.0	EC002637
ETIM 5.0	EC002637	ETIM 6.0	EC002637
UNSPSC	30-21-18-10	eClass 5.1	27-26-07-04
eClass 6.2	27-26-07-04	eClass 7.1	27-44-04-02
eClass 8.1	27-44-04-02	eClass 9.0	27-44-04-02
eClass 9.1	27-44-04-02		

Notes

Notes	<ul style="list-style-type: none"> • Additional colours on request • P on drawing = pitch • Rated data refer only to the component itself. Clearance and creepage distances to other components are to be designed in accordance with the relevant application standards.
-------	--

IPC conformity	Conformity: The products are developed, manufactured and delivered according international recognized standards and norms and comply with the assured properties in the data sheet resp. fulfill decorative properties in accordance with IPC-A-610 "Class 2". Further claims on the products can be evaluated on request.
----------------	--

Approvals

Approvals	
ROHS	Conform

**OMNIMATE Signal - series BC/SC 3.81
SC 3.81/06/90G 3.2SN GN BX**

Weidmüller Interface GmbH & Co. KG
Klingenbergstraße 16
D-32758 Detmold
Germany
Fon: +49 5231 14-0
Fax: +49 5231 14-292083
www.weidmueller.com

Technical data**Downloads**

Approval/Certificate/Document of Conformity	Declaration of the Manufacturer
Brochure/Catalogue	FL DRIVES EN MB DEVICE MANUF. EN FL DRIVES DE FL BUILDING SAFETY EN FL APPL LED LIGHTING EN FLIndustr.CONTROLS EN FL MACHINE SAFETY EN FL HEATING ELECTR EN FL APPL INVERTER EN FL_BASE_STATION_EN FL ELEVATOR EN FL POWER SUPPLY EN FL 72H SAMPLE SER EN PO OMNIMATE EN
Engineering Data	WSCAD

**OMNIMATE Signal - series BC/SC 3.81
SC 3.81/06/90G 3.2SN GN BX**

Weidmüller Interface GmbH & Co. KG
 Klingenbergstraße 16
 D-32758 Detmold
 Germany
 Fon: +49 5231 14-0
 Fax: +49 5231 14-292083
 www.weidmueller.com

Drawings

Dimensional drawing

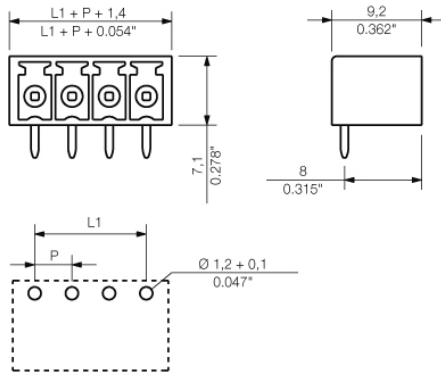

08

SC 3.81/.../90G 3.2....

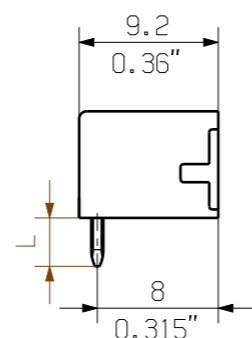
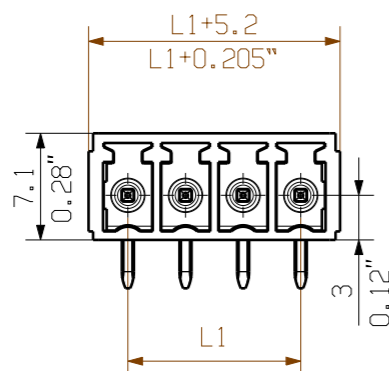

SC 3.81/.../90F 3.2...

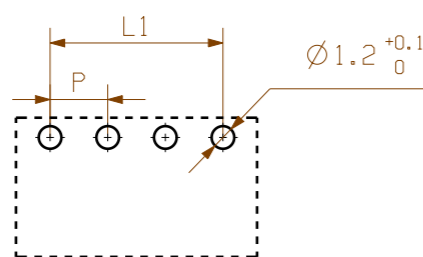
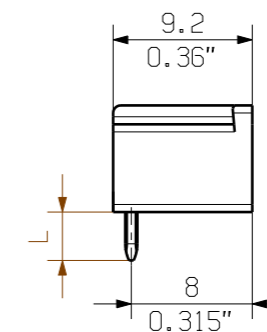
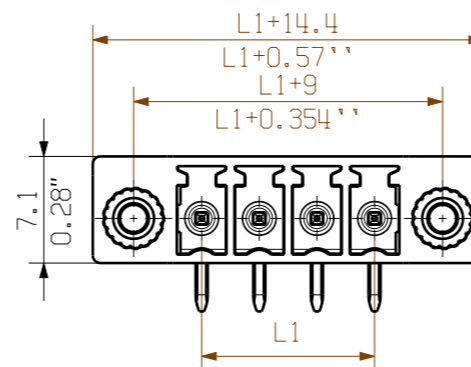

PCB LAYOUT

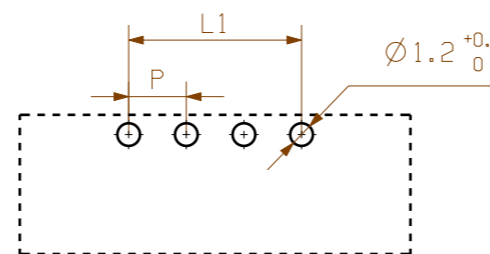

PCB LAYOUT

KUNDENZEICHUNG
CUSTOMER DRAWING

P=3.81

20	72.39	2.850
19	68.58	2.700
18	64.77	2.550
17	60.96	2.400
16	57.15	2.250
15	53.34	2.100
14	49.53	1.950
13	45.72	1.800
12	41.91	1.650
11	38.10	1.500
10	34.29	1.350
9	30.48	1.200
8	26.67	1.050
7	22.86	0.900
6	19.05	0.750
5	15.24	0.600
4	11.43	0.450
3	7.62	0.300
2	3.81	0.150
N	L1 [mm]	L1 [inch]

For the mounting of PCBs, it should be noted that the rated data given in the catalogue relates only to the connection elements. The necessary creepage and clearance paths must be observed in connection with the respective applicant in accordance to VDE 0110. The current-carrying capacity and pitch tolerance is to be determined according to DIN IEC 326 part 3 very fine.

Weidmüller connectors are tested to the DIN VDE 0627 standard, and are valid for its field of application. Provided that the connectors are used to the intended purpose, all requirements with respect to the occurring of electrical, mechanical, thermic and corrosive stress will be satisfied.

GENERAL TOLERANCE: DIN ISO 2768-m RoHS COMPLIANT	97482/0	01		C 40384 08 Drawing no. Issue no.
	06.09.17 MA_J			
Max. nos.	Modification		SC 3.81/.../90...3.2... ANSCHLUSS STIFTLAISTE PIN HEADER	
	Date	Name	Product file: SC 3.81	
Scale: 5/1	Drawn	09.02.2006	ZHANG_H	7069
Supersedes: .	Responsible		MA_J	
	Checked	13.09.2017	ZHOU_N	
	Approved		XU_S	

Recommended wave soldering profiles

Weidmüller Interface GmbH & Co. KG
 Klingenbergstraße 16
 D-32758 Detmold
 Germany
 Fon: +49 5231 14-0
 Fax: +49 5231 14-292083
 www.weidmueller.com

Single Wave:



Double Wave:



Wave soldering profiles

Wired connection elements should be processed in accordance with the DIN EN 61760-1 standard. We have included two recommendations for practical wave soldering profiles, with which Weidmüller PCB terminals and connectors are qualified.

When choosing a suitable profile for your application, the following factors also need to be considered:

- PCB thickness
- Proportion of Cu in the layers
- Single/double-sided assembly
- Product range
- Heating and cooling rates

The single and double wave profiles each indicate the recommended operating range, including the maximum soldering temperature of 260°C. In practice, the maximum soldering temperature is quite often well below the above maximum profile.