

## Printed-circuit board connector - DMCV 1,5/10-G1-3,5 P20THR - 1787289

Please be informed that the data shown in this PDF Document is generated from our Online Catalog. Please find the complete data in the user's documentation. Our General Terms of Use for Downloads are valid (<http://phoenixcontact.com/download>)

Header, nominal current: 8 A, rated voltage (III/2): 160 V, number of positions: 10, pitch: 3.5 mm, color: black, contact surface: Tin, mounting: THR soldering



The figure shows a 10-pos. version with 20 contacts

### Why buy this product

- ✓ Designed for integration into the SMT soldering process
- ✓ Vertical connection enables multi-row arrangement on the PCB
- ✓ Small component size for applications where space is at a premium

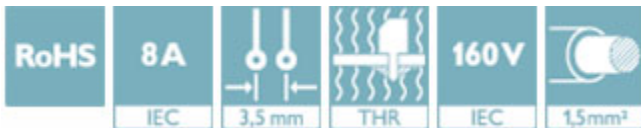

### Key Commercial Data

Packing unit	1 STK
GTIN	 4 046356 596909
GTIN	4046356596909
Weight per Piece (excluding packing)	4.000 g
Custom tariff number	85366930
Country of origin	Germany

### Technical data

#### Dimensions

Length [ l ]	10.6 mm
Pitch	3.5 mm
Dimension a	31.5 mm
Width [ w ]	35.8 mm
Constructional height	10 mm

# Printed-circuit board connector - DMCV 1,5/10-G1-3,5 P20THR - 1787289

## Technical data

### Dimensions

Height [ h ]	12 mm
Length of the solder pin	2 mm
Pin dimensions	0,8 x 0,8
Pin spacing	5.50 mm
Hole diameter	1.4 mm

### General

Range of articles	DMCV 1,5/..-G1-THR
Insulating material group	IIIa
Rated surge voltage (III/3)	2.5 kV
Rated surge voltage (III/2)	2.5 kV
Rated surge voltage (II/2)	2.5 kV
Rated voltage (III/3)	160 V
Rated voltage (III/2)	160 V
Rated voltage (II/2)	250 V
Connection in acc. with standard	EN-VDE
Nominal current I <sub>N</sub>	8 A
Maximum load current	8 A
Insulating material	LCP
Flammability rating according to UL 94	V0
Color	black
Number of positions	10

### Standards and Regulations

Connection in acc. with standard	EN-VDE
	CUL
Flammability rating according to UL 94	V0

### Environmental Product Compliance

China RoHS	Environmentally friendly use period: unlimited = EFUP-e
	No hazardous substances above threshold values

## Drawings

# Printed-circuit board connector - DMCV 1,5/10-G1-3,5 P20THR - 1787289

Diagram

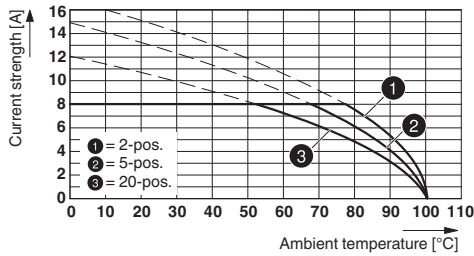

Schematic diagram

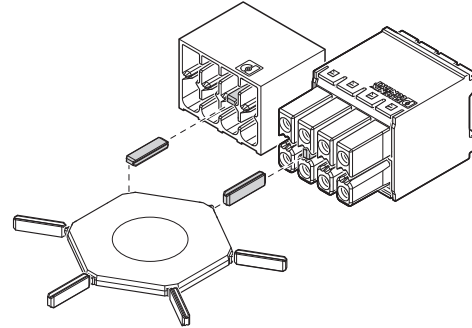

Typ: DFMC 1,5/...-ST-3,5 with DMCV 1,5/...-G1-3,5 P20 THR

Use of the CP-DMC... coding profile

Drilling diagram

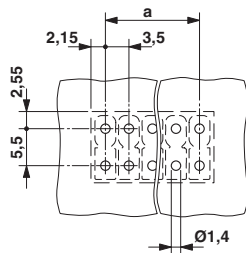

Dimensional drawing

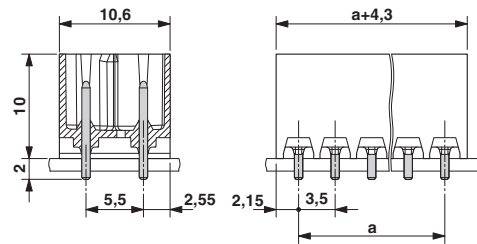

## Classifications

eCl@ss

eCl@ss 4.0	272607xx
eCl@ss 4.1	27260701
eCl@ss 5.0	27260701
eCl@ss 5.1	27260701
eCl@ss 6.0	27260704
eCl@ss 7.0	27440402
eCl@ss 8.0	27440402
eCl@ss 9.0	27440402

ETIM

ETIM 4.0	EC002637
ETIM 5.0	EC002637
ETIM 6.0	EC002637

# Printed-circuit board connector - DMCV 1,5/10-G1-3,5 P20THR - 1787289

## Classifications

### UNSPSC

UNSPSC 6.01	30211810
UNSPSC 7.0901	39121409
UNSPSC 11	39121409
UNSPSC 12.01	39121409
UNSPSC 13.2	39121409

## Approvals

### Approvals

#### Approvals

VDE Gutachten mit Fertigungsüberwachung / IECCE CB Scheme / cULus Recognized / EAC / cULus Recognized

#### Ex Approvals

### Approval details

VDE Gutachten mit Fertigungsüberwachung		<a href="http://www.vde.com/en/Institute/OnlineService/VDE-approved-products/Pages/Online-Search.aspx">http://www.vde.com/en/Institute/OnlineService/VDE-approved-products/Pages/Online-Search.aspx</a>	40038423
Nominal current I <sub>N</sub>		8 A	
Nominal voltage U <sub>N</sub>		160 V	

IECEE CB Scheme		<a href="http://www.iecee.org/">http://www.iecee.org/</a>	DE1-56070_B1_B2
Nominal current I <sub>N</sub>		8 A	
Nominal voltage U <sub>N</sub>		160 V	

cULus Recognized		<a href="http://database.ul.com/cgi-bin/XYV/template/LISEXT/1FRAME/index.htm">http://database.ul.com/cgi-bin/XYV/template/LISEXT/1FRAME/index.htm</a>	E60425-20110128
------------------	---	---	-----------------

# Printed-circuit board connector - DMCV 1,5/10-G1-3,5 P20THR - 1787289

## Approvals

EAC		B.01742
-----	--	---------

cULus Recognized		<a href="http://database.ul.com/cgi-bin/XYV/template/LISEXT/1FRAME/index.htm">http://database.ul.com/cgi-bin/XYV/template/LISEXT/1FRAME/index.htm</a>	E60425-20110128
	B	C	D
Nominal current I <sub>N</sub>	8 A	8 A	8 A
Nominal voltage U <sub>N</sub>	300 V	50 V	300 V

## Accessories

### Accessories

#### Coding element

Coding profile - CP-DMC 1,5 NAT - 1790647



Coding profile, for insertion between the coding ribs of the connector and the header following the reflow soldering process, insulating material, color: natural

## Additional products

Printed-circuit board connector - DFMC 1,5/10-ST-3,5 - 1790182

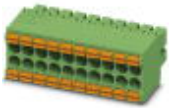

Plug, nominal current: 8 A, rated voltage (III/2): 160 V, number of positions: 10 with 20 contacts, pitch: 3.5 mm, connection method: spring-cage connection, color: green, contact surface: tin