

Accessories - MSTB-BF - 1759981

Please be informed that the data shown in this PDF Document is generated from our Online Catalog. Please find the complete data in the user's documentation. Our General Terms of Use for Downloads are valid (<http://phoenixcontact.com/download>)



Mounting flange, for fixing both ends of the header onto the PCB, green insulating material, with M 2 x 14 screws and nuts.



Key Commercial Data

Packing unit	1 pc
Minimum order quantity	50 pc
GTIN	 4 017918 030773
GTIN	4017918030773
Weight per Piece (excluding packing)	1.030 g
Custom tariff number	85369010
Country of origin	Germany

Technical data

Environmental Product Compliance

REACH SVHC	Lead 7439-92-1
China RoHS	Environmentally friendly use period: unlimited = EFUP-e
	No hazardous substances above threshold values

Drawings

Accessories - MSTB-BF - 1759981

Drilling diagram

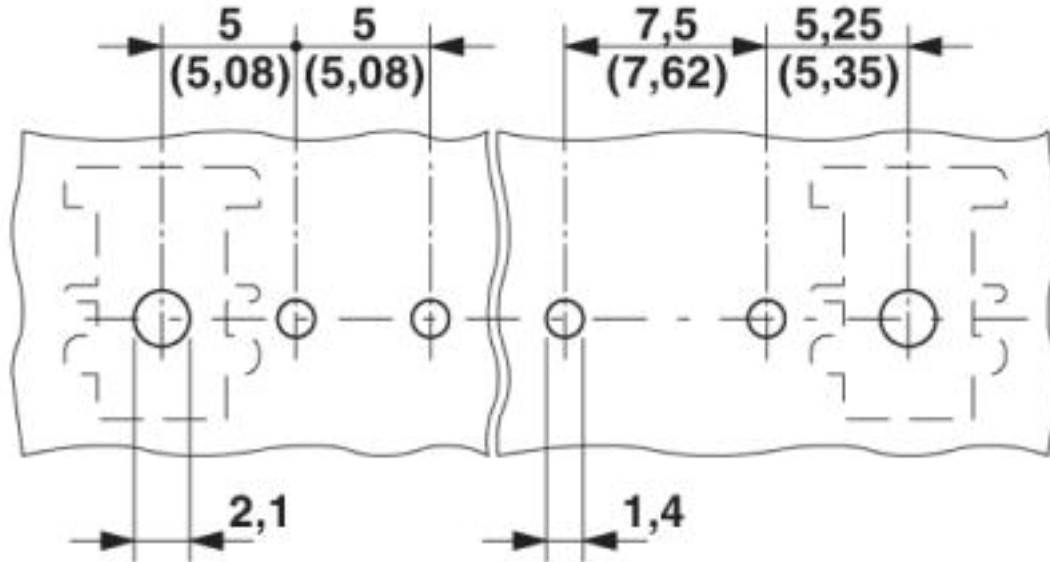

Vertically positioned header

Drilling diagram

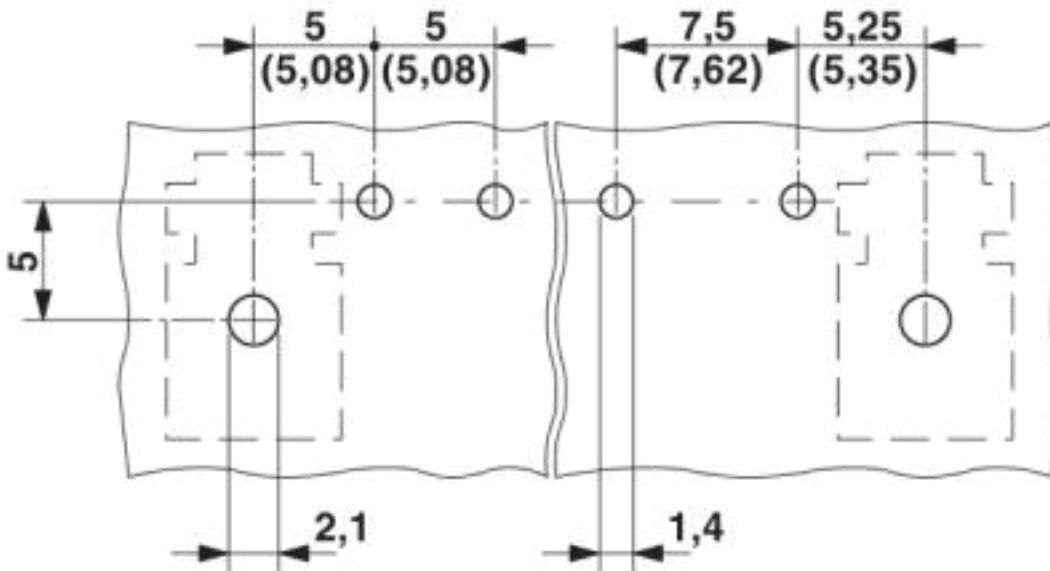

Horizontally positioned header

Accessories - MSTB-BF - 1759981

Classifications

eCl@ss

eCl@ss 10.0.1	27371392
eCl@ss 4.0	27378000
eCl@ss 4.1	27378000
eCl@ss 5.0	27379100
eCl@ss 5.1	27379100
eCl@ss 6.0	27379200
eCl@ss 7.0	27379201
eCl@ss 8.0	27379201
eCl@ss 9.0	27379201

ETIM

ETIM 3.0	EC000464
ETIM 4.0	EC002498
ETIM 5.0	EC002498
ETIM 6.0	EC002498
ETIM 7.0	EC002498

UNSPSC

UNSPSC 6.01	30211810
UNSPSC 7.0901	39121409
UNSPSC 11	39121409
UNSPSC 12.01	39121409
UNSPSC 13.2	39121421
UNSPSC 18.0	39121421
UNSPSC 19.0	39121421
UNSPSC 20.0	39121421
UNSPSC 21.0	39121421

Approvals

Approvals

Approvals

EAC

Ex Approvals

Accessories - MSTB-BF - 1759981

Approvals

Approval details

EAC		B.01742
-----	---	---------