

## Base strip - MSTBVA 2,5/ 4-G-5,08 - 1755752

Please be informed that the data shown in this PDF Document is generated from our Online Catalog. Please find the complete data in the user's documentation. Our General Terms of Use for Downloads are valid (<http://phoenixcontact.com/download>)

Header, Nominal current: 12 A, Rated voltage (III/2): 320 V, Number of positions: 4, Pitch: 5.08 mm, Color: green, Contact surface: Tin, Mounting: Wave soldering



The figure shows a 10-position version of the product

### Why buy this product

- Other pin lengths available on request
- Versions with and without side panel
- Plug-in direction parallel and vertical to the PCB
- Standard pin strip for 320 V (III/2)



### Key Commercial Data

Packing unit	250 pc
GTIN	 4 017918 029333
Weight per Piece (excluding packing)	1.58 g
Custom tariff number	85366990
Country of origin	Germany

### Technical data

#### Dimensions

Length	8.6 mm
Pitch	5.08 mm
Dimension a	15.24 mm
Width	22.32 mm
Constructional height	12 mm
Height	15.9 mm
Length of the solder pin	3.9 mm
Pin dimensions	1 x 1 mm
Hole diameter	1.4 mm

# Base strip - MSTBVA 2,5/ 4-G-5,08 - 1755752

## Technical data

### General

Range of articles	MSTBVA 2,5/...-G
Insulating material group	I
Rated surge voltage (III/3)	4 kV
Rated surge voltage (III/2)	4 kV
Rated surge voltage (II/2)	4 kV
Rated voltage (III/3)	250 V
Rated voltage (III/2)	320 V
Rated voltage (II/2)	630 V
Connection in acc. with standard	EN-VDE
Nominal current I <sub>N</sub>	12 A
Maximum load current	12 A
Insulating material	PA
Flammability rating according to UL 94	V0
Color	green
Number of positions	4

### Standards and Regulations

Connection in acc. with standard	EN-VDE
	CSA
Flammability rating according to UL 94	V0

## Classifications

### eCl@ss

eCl@ss 4.0	272607xx
eCl@ss 4.1	27260701
eCl@ss 5.0	27260701
eCl@ss 5.1	27260701
eCl@ss 6.0	27260704
eCl@ss 7.0	27440402
eCl@ss 8.0	27440402
eCl@ss 9.0	27440402

### ETIM

ETIM 3.0	EC001121
ETIM 4.0	EC002637
ETIM 5.0	EC002637

### UNSPSC

UNSPSC 6.01	30211810
UNSPSC 7.0901	39121409
UNSPSC 11	39121409

# Base strip - MSTBVA 2,5/ 4-G-5,08 - 1755752

## Classifications

### UNSPSC

UNSPSC 12.01	39121409
UNSPSC 13.2	39121409

## Approvals

### Approvals

#### Approvals

CSA / VDE Gutachten mit Fertigungsüberwachung / IECCEB Scheme / EAC / cULus Recognized

#### Ex Approvals

#### Approvals submitted

### Approval details

CSA 		
	B	D
Nominal current IN	12 A	10 A
Nominal voltage UN	300 V	300 V

VDE Gutachten mit Fertigungsüberwachung 	
Nominal current IN	12 A
Nominal voltage UN	250 V

IECCEB Scheme 	
Nominal current IN	12 A
Nominal voltage UN	250 V

EAC
-----

# Base strip - MSTBVA 2,5/ 4-G-5,08 - 1755752

## Approvals

cULus Recognized		
	B	D
Nominal current I <sub>N</sub>	12 A	10 A
Nominal voltage U <sub>N</sub>	300 V	300 V

## Drawings

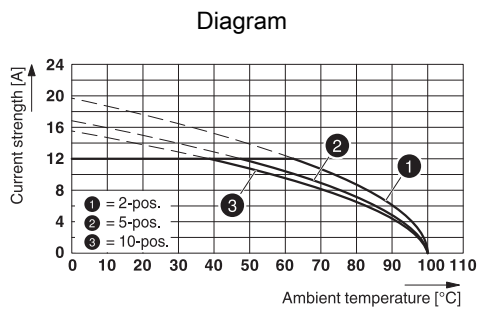

Type: TVMSTB 2,5/...-ST-5,08 with MSTBVA 2,5/...-G-5,08

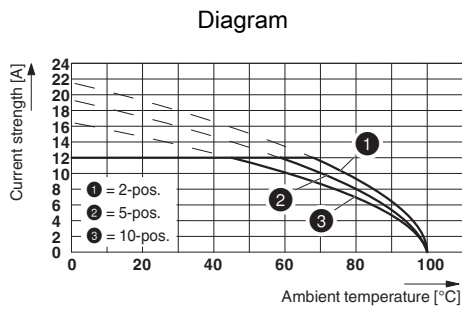
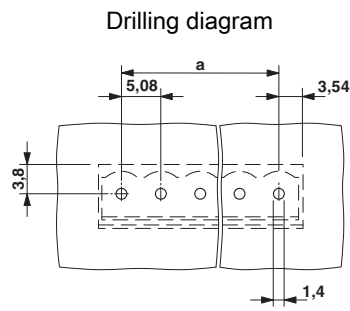

Type: TFKC 2,5/...-ST-5,08 with MSTBVA 2,5/...-G-5,08

